

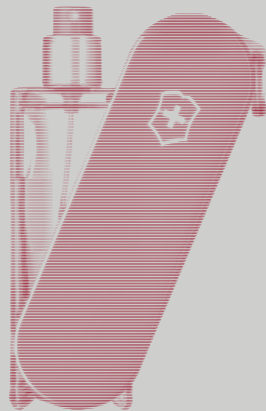

VICTORINOX



CORNER, COUNTER, DISPLAY & FIXTURE CATALOGUE

VICTORINOX RETAIL 2015



MAKERS OF THE ORIGINAL SWISS ARMY KNIFE



CORNER FRAME OPTIONS

The Backwall is a modular free standing combination of elements that can be changed to suit the different product categories.

Corner with a red Frame

The frame in Victorinox red is a great eyecatcher.



Corner with a grey frame

The grey frame provides a different look and feel to suit the local requirements.



Corner with no frame

The backwall without the frame surround allows the system to be installed where there are restrictive ceiling heights. The additional top panel lighting ensures a well illuminated backwall.





COUNTER OPTIONS

COUNTER BACKWALL

A single freestanding backwall showing the Victorinox Swiss Army logo.
To be used for watches only.



VICTORINOX LOGO

800mm
Stainless Steel
with red underline

CONCRETE LOOK

Backpanels

STAND-ALONE COUNTER

Single freestanding cabinet



COUNTER GROUP

Combination of a freestanding cabinet, watch display table, and freestanding double vitrine.





WATCH DISPLAY FOR WINDOWS



SAK IN-DISPLAY FOR CABINET OR VITRINE



ROTATING POCKET TOOL COUNTER TOP DISPLAY TOWER



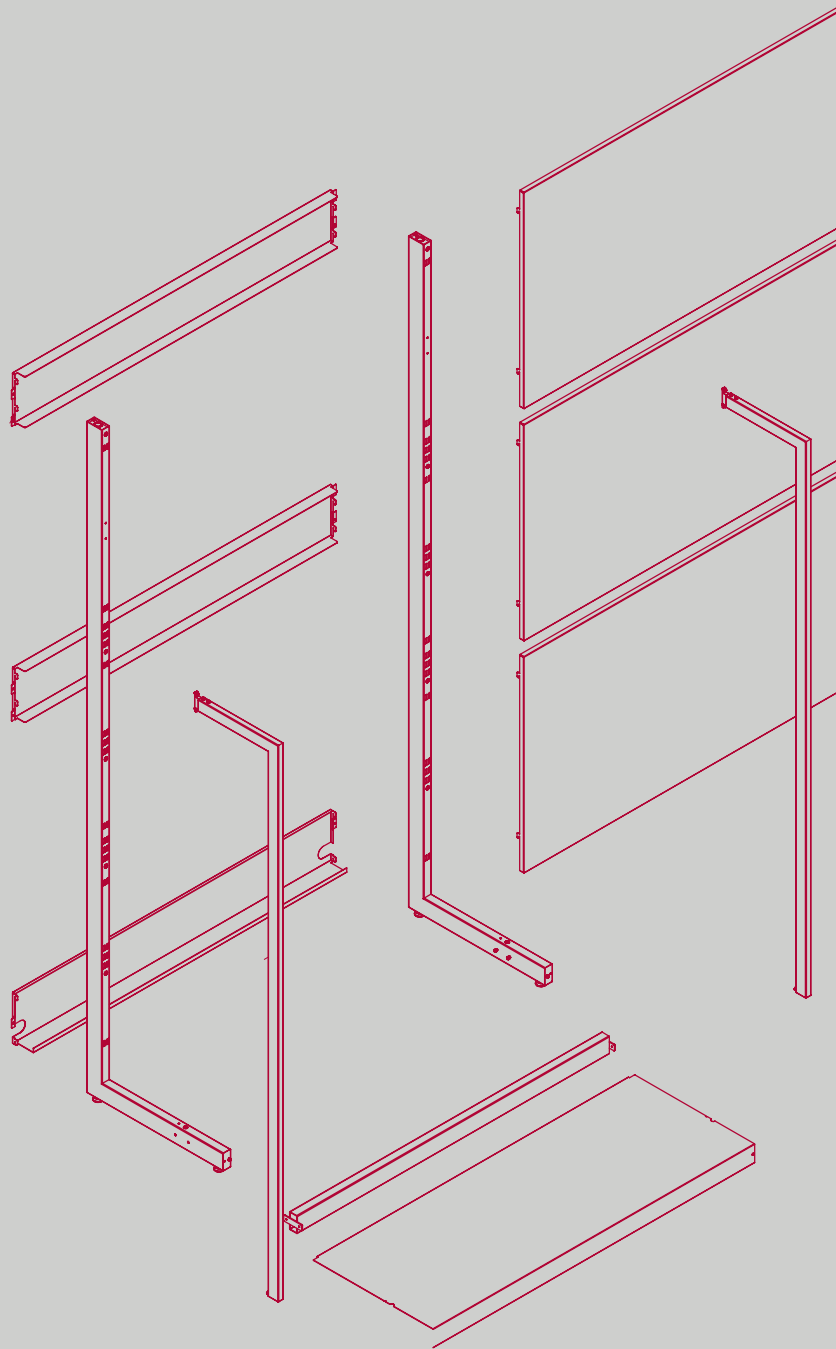

2.0

BACKWALL COMPONENTS

2.0 CORNER BACKWALL COMPONENTS

1280MM WIDE BACKWALL SUPPORT FRAMES

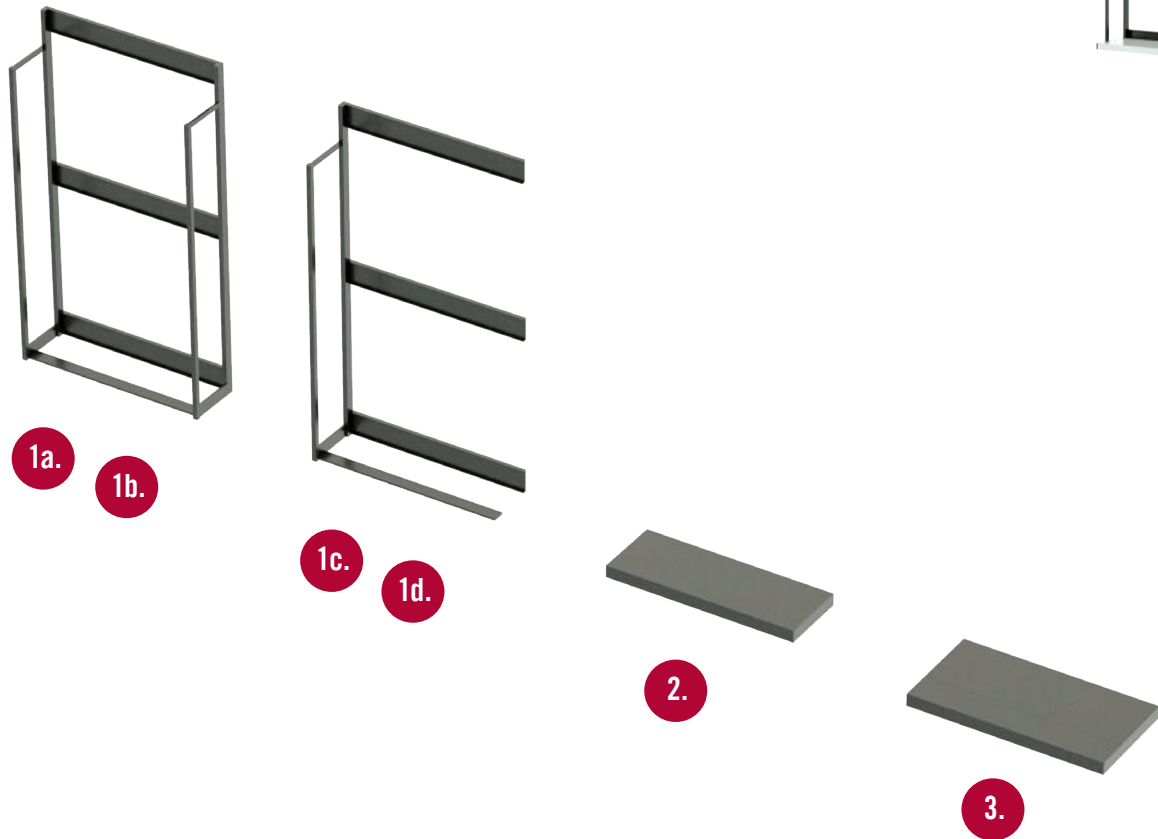

1a. Backwall support rack without illumination, 1280mm

- ▲ *Item no. 9.5350.01*
L1250 x D550 x H2250mm
-

1b. Backwall support rack with illumination, 1280mm

- ▲ *Item no. 9.5350.02*
L1250 x D550 x H2250mm
-

1c. Backwall support rack extension piece without illumination frame, 1280mm

- ▲ *Item no. 9.5350.03*
L1250 x D550 x H2250mm
-

1d. Backwall support rack extension piece with illumination, 1280mm

- ▲ *Item no. 9.5350.04*
L1250 x D500mm
-

2. Standard base 500mm deep, 1250mm

- ▲ *Item no. 9.5350.10*
L1250 x D650mm
-

3. Deep base cover 650mm, 1250mm

- ▲ *Item no. 9.5350.11*
L1250 x H2250mm
-



1250MM WIDE BACKWALL PANELS

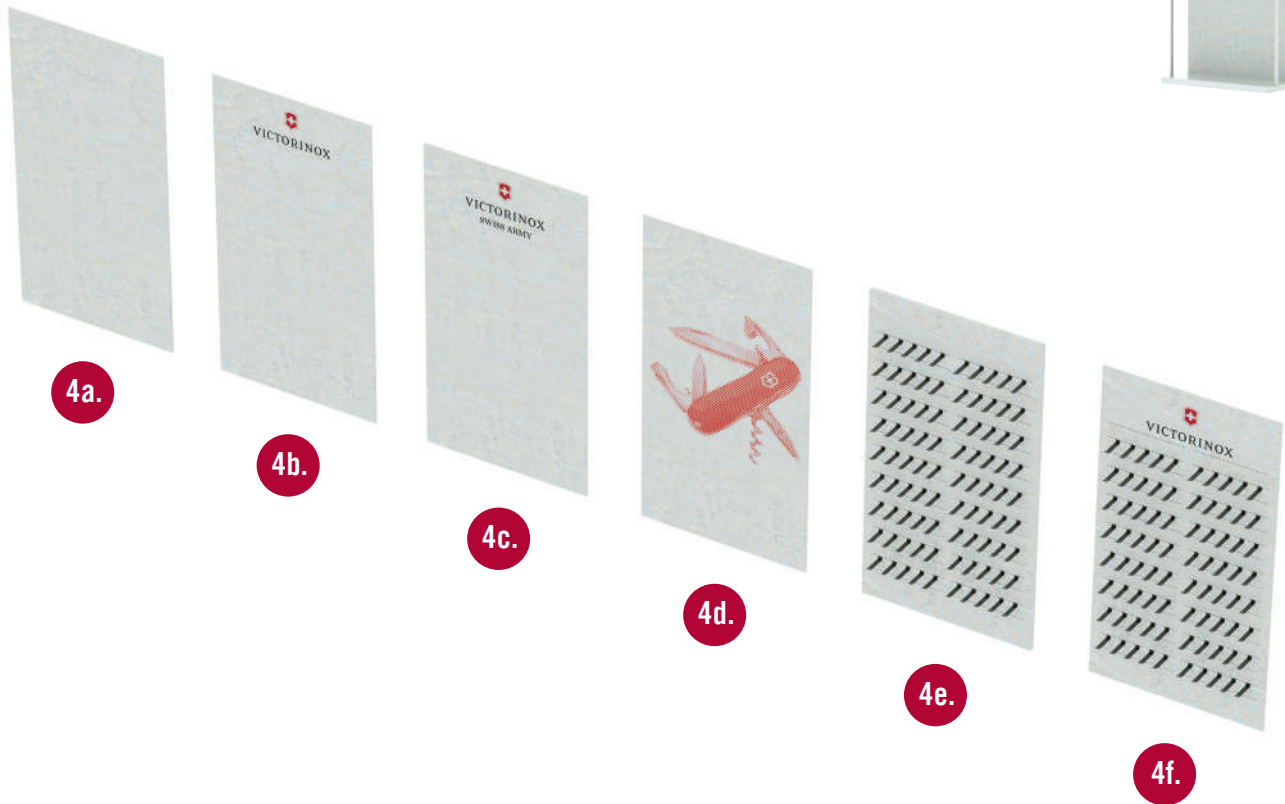

4a. Backwall panel set without logo, 1250mm

- ▲ *Item no. 9.5350.20*
L1250 x H2250mm
-

4d. Backwall panel set with SAK graphic, 1250mm

- ▲ *Item no. 9.5350.23*
L1250 x H2250mm
-

4b. Backwall panel set with Victorinox logo, 1250mm

- ▲ *Item no. 9.5350.21*
L1250 x H2250mm
-

4e. Backwall blister panel set without logo, 1250mm

- ▲ *Item no. 9.5350.24*
L1250 x H2250mm
-

4c. Backwall panel set with Victorinox Swiss Army logo, 1250mm

- ▲ *Item no. 9.5350.22*
L1250 x H2250mm
-

4f. Backwall blister panel set with Victorinox logo, 1250mm

- ▲ *Item no. 9.5350.25*
L1250 x H2250mm
-

2.0 CORNER BACKWALL COMPONENTS

655MM WIDE BACKWALL SUPPORT FRAMES

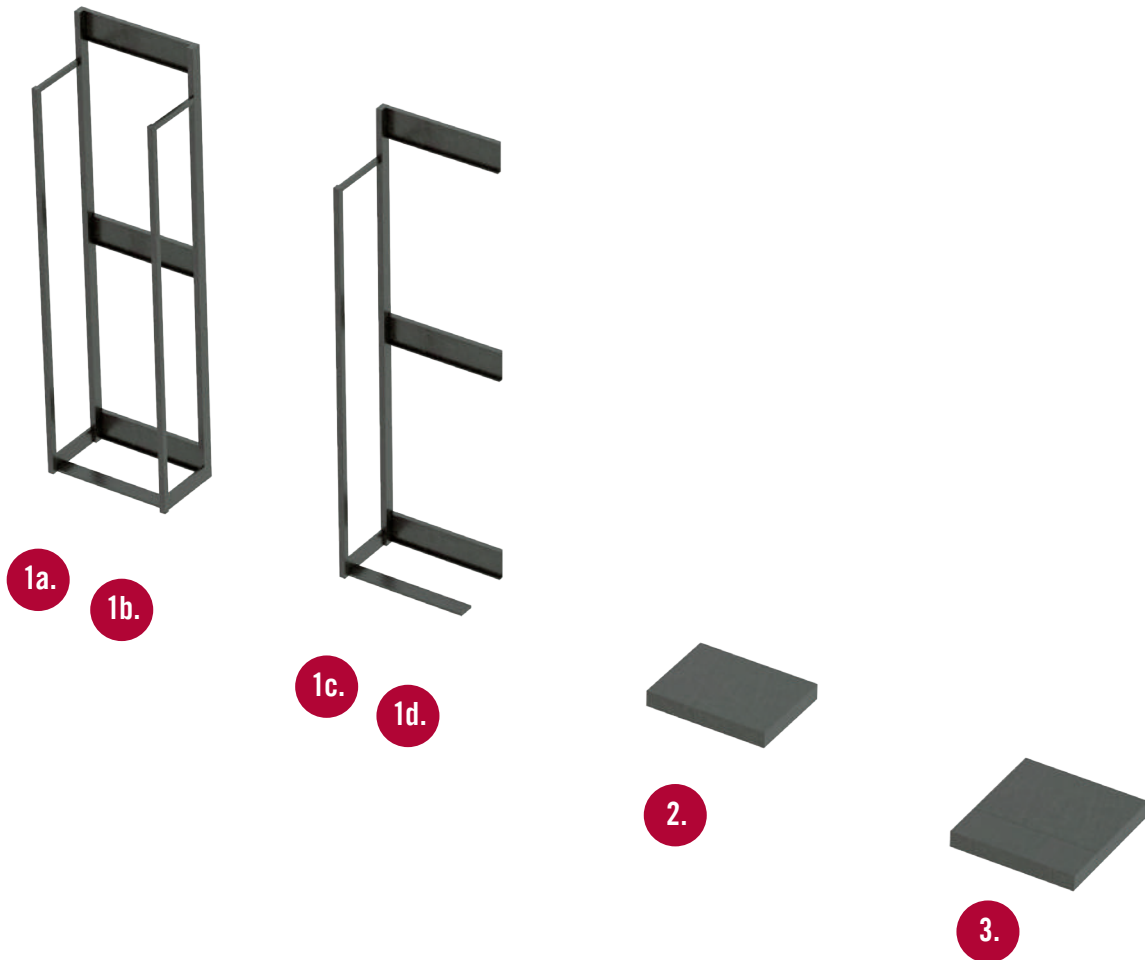

1a. Backwall support rack without illumination, 655mm

- ▲ *Item no. 9.5351.01*
L625 x D550 x H2250mm

1b. Backwall support rack with illumination, 655mm

- ▲ *Item no. 9.5351.02*
L625 x D550 x H2250mm

1c. Backwall support rack extension piece without illumination, 655mm

- ▲ *Item no. 9.5351.03*
L625 x D550 x H2250mm

1d. Backwall support rack extension piece with illumination, 655mm

- ▲ *Item no. 9.5351.04*
L625 x D550 x H2250mm

2. Standard base cover 500mm deep, 625mm

- ▲ *Item no. 9.5351.10*
L625 x D500mm

3. Deep base cover 650mm, 625mm

- ▲ *Item no. 9.5351.11*
L625 x D650mm



625MM WIDE BACKWALL PANELS



4a.



4b.



4c.



4d.



4e.



4f.

4a. Backwall panel set without logo, 625mm

- ▲ *Item no. 9.5351.20*
L625 x H2250mm

4d. Backwall blister panel set without logo, 625mm

- ▲ *Item no. 9.5351.23*
L625 x H2250mm

4b. Backwall panel set with Victorinox logo, 625mm

- ▲ *Item no. 9.5351.21*
L625 x H2250mm

4e. Backwall blister panel set with Victorinox logo, 625mm

- ▲ *Item no. 9.5351.24*
L625 x H2250mm

4c. Backwall panel set with Victorinox Swiss Army logo, 625mm

- ▲ *Item no. 9.5351.22*
L625 x H2250mm

4f. Back panel with mirror, 625mm

- ▲ *Item no. 9.5351.25*
L625 x H2250mm

2.0 CORNER BACKWALL COMPONENTS

CORNER BACKWALL FRAME AND PANEL



Backwall Corner module, 500mm deep

◀ *Item no. 9.5352.01*
L550 x D550 x H2250mm



Backwall Corner module, 650mm deep

◀ *Item no. 9.5352.02*
L700 x D700 x H15mm



LIGHTING AND POWER ACCESSORIES



Small Top panel light (without frame)

◀ *Item no. 9.5357.02*

L625mm long



Large Top panel light (without frame)

◀ *Item no. 9.5357.01*

L1250mm long



Frame logo light

◀ *Item no. 9.5357.10*

L1250mm long



Electric cable

◀ *Item no. 9.5357.20*

NOTE

Electric cable to connect up to six cables from each backwall light transformer.

2.0 CORNER BACKWALL COMPONENTS

RED FRAME PANELS



Side frame panel red

▲ *Item no. 9.5355.01*
L300 x D550 x H2700mm



Top frame panel red with illumination, 1250mm

▲ *Item no. 9.5355.03*
L1250 x D550 x H450 mm

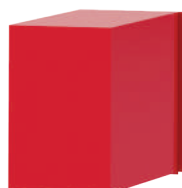

Top frame panel red with illumination, 625mm

◀ *Item no. 9.5355.04*
L625 x D550 x H450mm



Top frame panel red with Victorinox logo, with illumination, 1250mm

▲ *Item no. 9.5355.05*

L1250 x D550 x H450mm

Top frame panel red with Victorinox Swiss Army logo, with illumination, 1250mm

▲ *Item no. 9.5355.06*

L1250 x D550 x H450mm

2.0 CORNER BACKWALL COMPONENTS

GREY FRAME PANELS



Side frame panel grey

▲ *Item no. 9.5354.01*
L300 x D550 x H2700mm



Top frame panel grey with illumination, 1250mm

▲ *Item no. 9.5354.03*
L1250 x D550 x H450mm

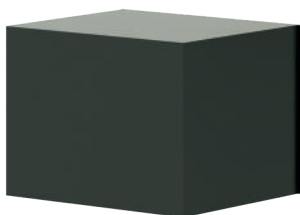

Top frame panel grey with illumination, 625mm

◀ *Item no. 9.5354.04*
L625 x D550 x H450mm



Top frame panel grey with Victorinox logo, with illumination, 1250mm

▲ *Item no. 9.5354.05*
L1250 x D550 x H450mm



Top frame panel grey with Victorinox Swiss Army logo, with illumination, 1250mm

▲ *Item no. 9.5354.06*
L1250 x D550 x H450mm

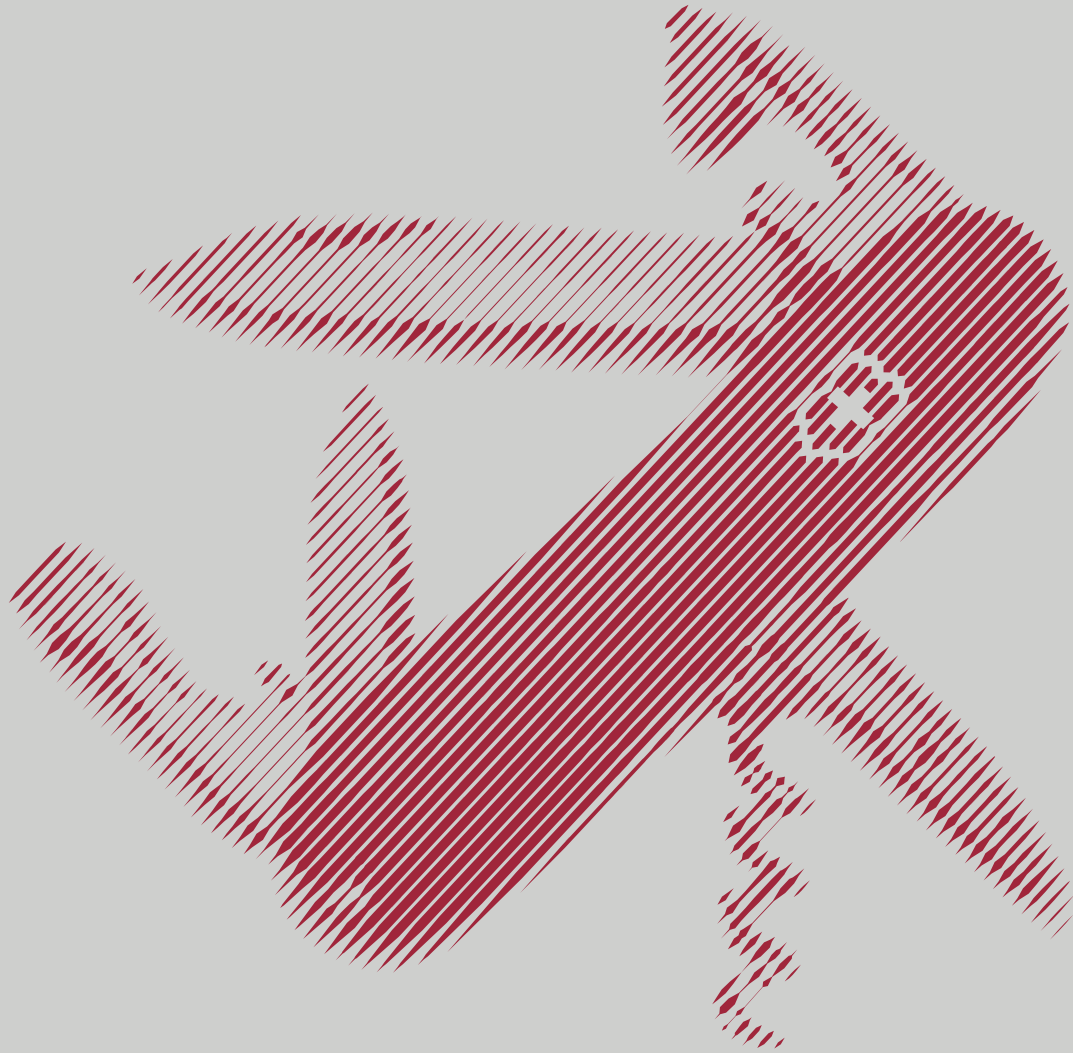

3.0

SAK AND CUTLERY COMPONENTS

3.0 SAK AND CUTLERY COMPONENTS

CORNER AND COUNTER

BACKWALL
compatible

FREE
STANDING
compatible

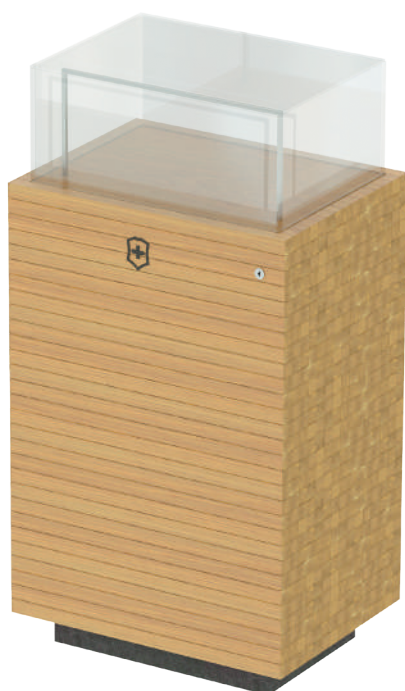

Small cabinet

◀ *Item no. 9.5370*
L600 x D450 x H1140mm

COMPONENTS Sliding top display drawer with lights.
One opening door with two inside drawers
Can be incorporated onto the base unit
of a backwall system or installed as a
freestanding fixture.

Display set that needs to be ordered separately:



SAK in-Display set for small cabinet

▲ *Item no. 9.5370.10*
L450 x D300 x H150mm



BACKWALL
compatible

FREE
STANDING
compatible



Large cabinet

◀ *Item no. 9.5371*
L1200 x D450 x H1140mm

COMPONENTS Sliding top display drawer with lights.
Two opening doors with four inside drawers
Can be incorporated onto the base unit of a
backwall system or installed as a freestanding
fixture.

Display set that needs to be ordered separately:



SAK in-Display set for large cabinet

▲ *Item no. 9.5371.10*
L1000 x D300 x H220mm

3.0 SAK AND CUTLERY COMPONENTS

CORNER AND COUNTER

BACKWALL
compatible

FREE
STANDING
compatible

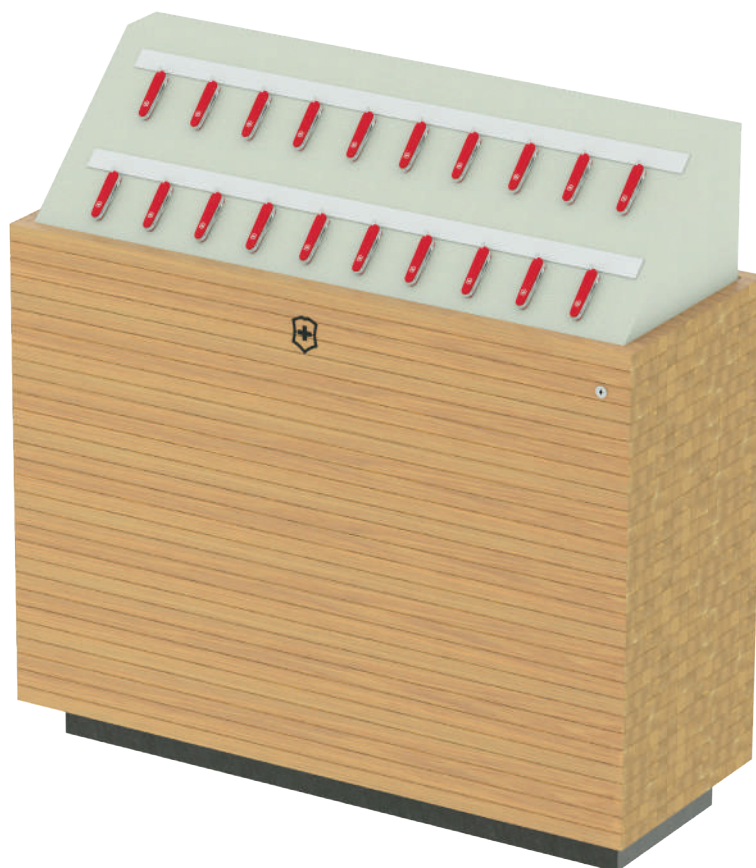

SAK tester cabinet

▲ Item no. 9.5372

L1200 x D450 x H1140mm

COMPONENTS Incorporating lower drawers for stock storage and SAK display on yo-yo cords. Includes 1 top drawer, two opening doors below. Inside four drawers. Includes 32 Swiss Army Knives. Knives incorporated onto the base unit of backwall system or be freestanding.



FREE
STANDING
compatible



Large tower with Victorinox logo

◀ *Item no. 9.5375.01*
L450 x D450 x H1840mm

COMPONENTS Top display with glass shelf and illumination.

NOTE Two displays need to be ordered for this tower.

Display set that needs to be ordered separately:



SAK in-display set for large tower

▲ *Item no. 9.5375.10*
L300 x D300 x H150mm

3.0 SAK AND CUTLERY COMPONENTS

CORNER AND COUNTER

BACKWALL
compatible

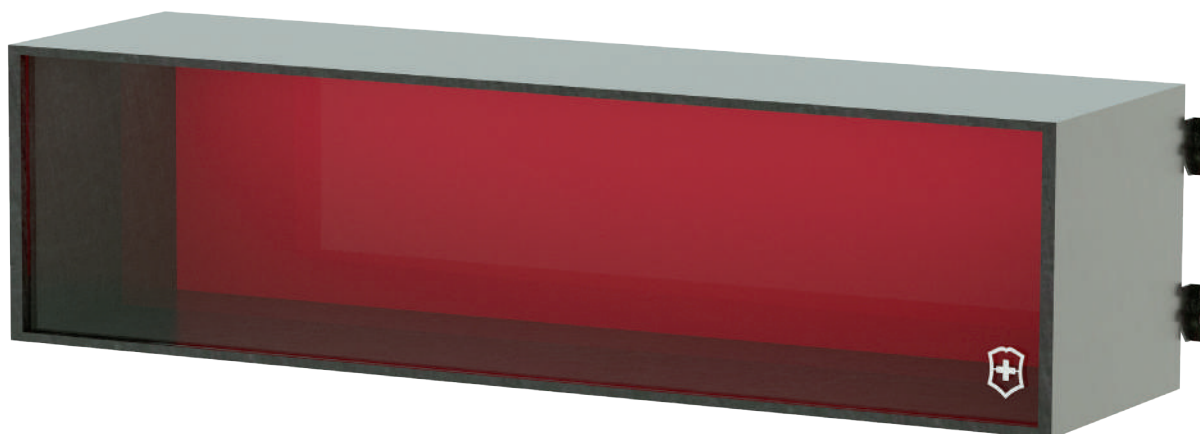

Backwall vitrine, 1250mm

▲ *Item no. 9.5358*

L1225 x D320 x H330mm

NOTE Element fixes onto backwall frame.

Display set that needs to be ordered separately:



SAK in-display set for Backwall vitrine

▲ *Item no. 9.5371.10*

L1000 x D300 x H220 mm

Backpanel 220mm high



FREE
STANDING
compatible



Freestanding double vitrine with Victorinox logo, 1250mm

◀ *Item no. 9.5356.01*

L1250 x D480 x H2250mm

NOTE Two display sets need to be ordered
for this vitrine.

Display set that needs to be ordered separately:



9.5371.10

▲ *Item no.*

L1000 x D300 x H220 mm

Backpanel 220mm high

3.0 SAK AND CUTLERY COMPONENTS

CORNER AND COUNTER



BACKWALL
compatible



SAK and Cutlery display without lights

▲ *Item no. 9.5359.01*
L1225 x D90 x H740mm

COMPONENTS 100 pcs. Magnets \varnothing 7mm (0.30), 30 pcs. Magnets \varnothing 4mm (0.12), 1 Set Magnet price tags (8.00)

NOTE Element fixes onto backwall frame

BACKWALL
compatible

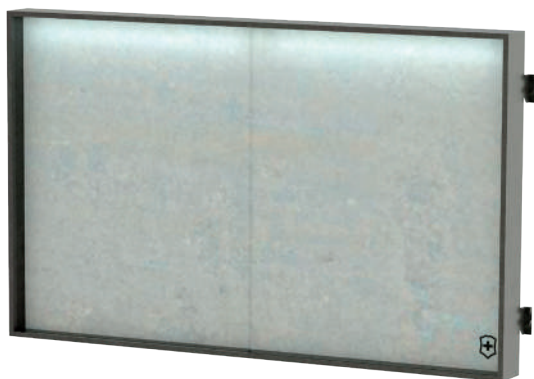

SAK and Cutlery display with lights

▲ *Item no. 9.5359.02*
L1225 x D90 x H740mm

COMPONENTS 100 pcs. Magnets \varnothing 7mm (0.30), 30 pcs. Magnets \varnothing 4mm (0.12), 1 Set Magnet price tags (8.00)

NOTE Element fixes onto backwall frame



WALL
MOUNTED
VERSION



SAK and Cutlery display without lights, for independant wall mounting

▲ *Item no. 9.5359.10*
L1225 x D90 x H740mm

COMPONENTS 100 pcs. Magnets \varnothing 7mm (0.30), 30 pcs. Magnets \varnothing 4mm (0.12), 1 Set Magnet price tags (8.00)

NOTE Element fixes to independant wall

3.0 SAK AND CUTLERY COMPONENTS

CORNER AND COUNTER

FREE
STANDING
compatible



Rotating blister tower for 60 blister hooks

◀ *Item no. 9.5376*
L600 x D600 x H1510 mm

COMPONENTS **Lower stock cabinet and top section internal storage.**

NOTE **Blister hooks need to be ordered separately.**

FREE
STANDING
compatible



Large free standing blister

◀ *Item no. 9.5377.01*
L550 x H1510mm

NOTE **Blister hooks need to be ordered separately.**



BACKWALL
compatible

FREE
STANDING
compatible



Top tray with 5 compartments to fit with blister backwall panels

◀ *Item no. 9.5361*
L432 x D175 x H150mm

BACKWALL
compatible

FREE
STANDING
compatible



Blister hook 120mm, Ø4.2 mm

◀ *Item no. 9.5363.01*
120mm



Blister hook 200mm, Ø4.2 mm

◀ *Item no. 9.5363.03*
200mm



Blister hook 250mm, Ø4.2 mm

◀ *Item no. 9.5363.04*
250mm

3.0 SAK AND CUTLERY COMPONENTS

DISPLAY



SAK in-display set for large tower

▲ *Item no. 9.5375.10*
L300 x D300 x H150mm

COMPONENTS 1 base, 1 backwall, 2 30mm high cube, 2 60mm high cubes, 1 85mm high cubes, cube & 20 knife holders.



SAK in-Display set for small cabinet

▲ *Item no. 9.5370.10*
L450 x D300 x H150mm

COMPONENTS 1 base, 1 backwall, 2 30mm high cube, 2 60mm high cubes, 1 85mm high cubes, cube & 20 knife holders.



SAK in-display set for large cabinet and backwall display vitrine

▲ *Item no. 9.5371.10*

L1000 x D300 x H220 mm

Backpanel 220mm high

COMPONENTS 1 base, 1 backwall, 2 85mm high cubes, 3 60mm high cubes, 1 30mm high cube & 30 knife holders.

3.0 SAK AND CUTLERY COMPONENTS

DISPLAY



Small SAK display set

▲ *Item no. 9.5300.01*

Extended L510 x D365 x H350mm

Closed L300 x D365 x H350mm

COMPONENTS 1 base, 1 backwall, 1 display graphic, 1 30mm high cube, 1 60mm high cube, 2 85mm high cubes,
1 wooden SAK holder & 20 knife holders.

New display graphic

▲ *Item no. X.95300.01*

VKP/CHF 7.40



Medium SAK display set

▲ *Item no. 9.5300.02*

Extended L910 x D365 x H500mm

Closed L500 x D365 x H500mm

COMPONENTS 1 base, 1 backwall, 1 display graphic, 2 30mm high cubes, 2 60mm high cube, 2 85mm high cubes, 1 king size cube, 1 wooden SAK holder & 25 knife holders.

New display graphic

▲ *Item no. X.95300.02*

3.0 SAK AND CUTLERY COMPONENTS

DISPLAYS & FURNITURE COMPONENTS



Large SAK display set

▲ *Item no. 9.5300.03*
L760 x D380 x H1000mm

COMPONENTS 1 base, 1 backwall, 1 display graphic, 1 30mm high cube, 1 60mm high cube, 2 85mm high cubes, 1 king size cube, 1 medium weighted cube & 40 knife holders.

New display graphic

▲ *Item no. X.95300.03*



Small knife stand, incl. SAK holder

◀ *Item no. 9.5302.01*
L50 x D50 x H30mm

COMPONENTS 1 knife holder
 1 30mm high cube



Medium knife stand, incl. SAK holder

◀ *Item no. 9.5302.02*
L50 x D50 x H60mm

COMPONENTS 1 Knife holder
 1 60mm high cube

3.0 SAK AND CUTLERY COMPONENTS

DISPLAY



Large knife stand, incl. SAK holder

◀ *Item no. 9.5302.03*
L50 x D50 x H85mm

COMPONENTS 1 Knife holder
 1 85mm high cube

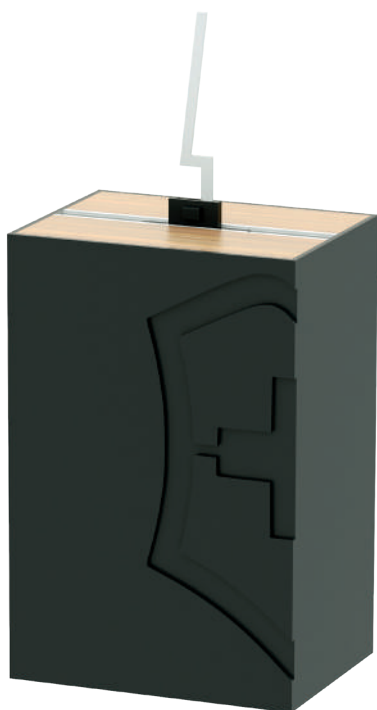

King size cube, incl. SAK holder

◀ *Item no. 9.5302.04*
L80 x D60 x H120mm

COMPONENTS 1 Knife holder
 1 King size cube

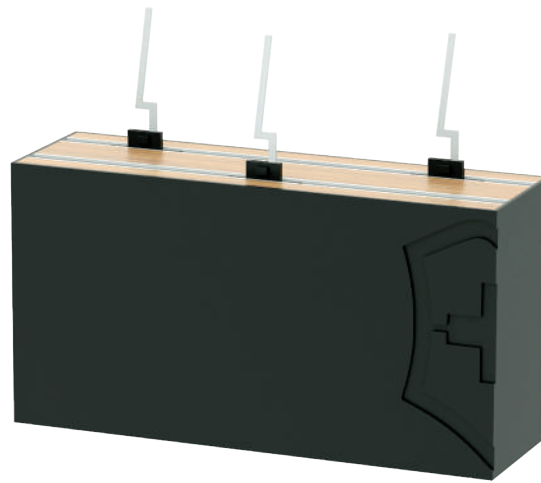

Weighted display cube L200 incl. 3 SAK holder

▲ *Item no. 9.5302.05*
L200 x D60 x H105mm

COMPONENTS 3 Knife holder, 1 weighted display cube



Small single SAK stand

◀ *Item no. 9.5105*
L50 x D50 x H25 mm

3.0 SAK AND CUTLERY COMPONENTS

DISPLAY



Large single SAK stand

◀ *Item no. 9.6042*
∅90mm x H17mm



Wooden SAK stand

◀ *Item no. 9.5303*
L60 x D60 x H20mm



SAK holder

◀ *Item no. 9.5304*



Small and large SAK tray set

- ◀ *Item no. 9.5305*
L205 x D255 x H18mm
L205 x D150 x H18mm

COMPONENTS 15 SAK holders



SAK display tray

- ◀ *Item no. 9.6120*
L240 x D330mm

COMPONENTS **Presentation tray Inlay for:
20 pcs various pocket/multi tools**

DIFFERENT INLAYS AVAILABLE

- ◀ *Item no. 9.6120.1*
for 18 pcs. pocket tools 91mm
 - ◀ *Item no. 9.6120.2*
for 9 pcs. multitools 111mm, 5 pcs
pocket tools 84mm, and Swiss card
 - ◀ *Item no. 9.6120.3*
for 21 pcs pocket tools 58mm, and Swiss tool
-

3.0 SAK AND CUTLERY COMPONENTS

DISPLAY



Electric knife display 110V

◀ *Item no. 9.6001.1*
H800 x L600 x D250



Electric knife display 220V

◀ *Item no. 9.6001.2*
H800 x L600 x D250



Small SAK box for 50 "Classic"

◀ *Item no. 9.5110*
L280 x D200 x H160mm

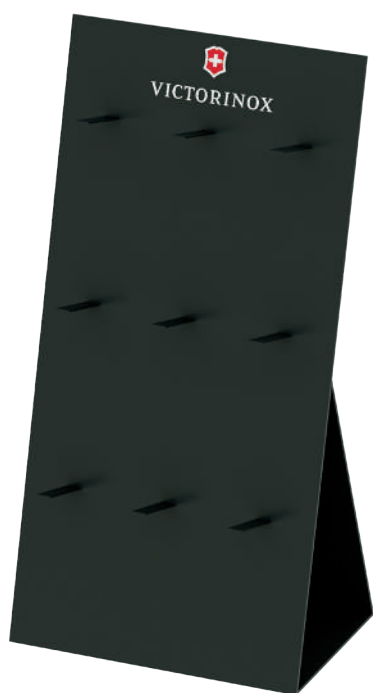

Large SAK display stand

◀ *Item no. 9.6329*
L410 x D269 x H810mm

3.0 SAK AND CUTLERY COMPONENTS

DISPLAY

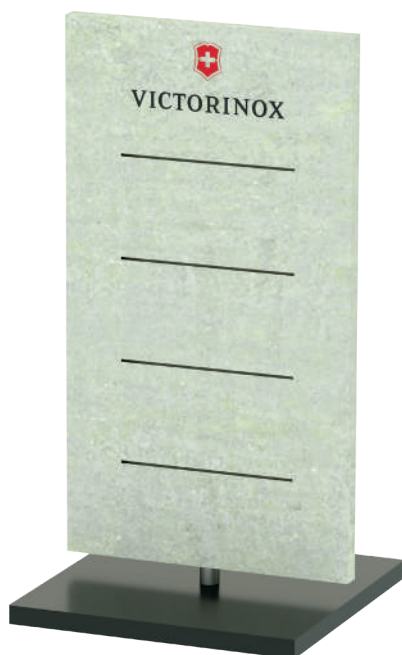

Rotating blister spinner

◀ *Item no. 9.5313*
L305 x D305 x H610mm



Rotating SAK display with storage

◀ *Item no. 9.5314*
L305 x D305 x H610mm

COMPONENTS 20 pcs. magnets Ø 7mm
 20 pcs. magnets Ø 4mm
 1 set magnet price tags



Glass cabinet with lights, 110V/220V

Item no. 9.5315 ▶

L305 x D305 x H610

NOTE

Two display sets needs to be ordered for this Item.

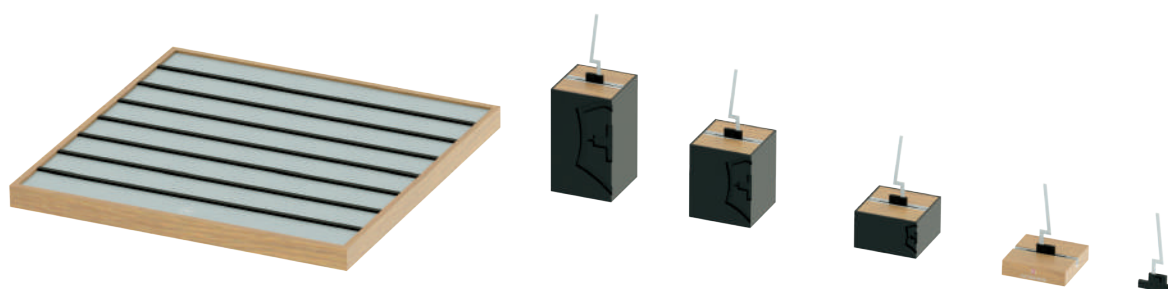

SAK in-display set for glass cabinet

▶ Item no. 9.5315.10

L260 x W220 x H18mm

COMPONENTS

1 tray, 1 85mm high cubes, 1 60mm high cubes, 1 30mm high cube, 1 wooden SAK holder & 15 knife holders.

3.0 SAK AND CUTLERY COMPONENTS

DISPLAY

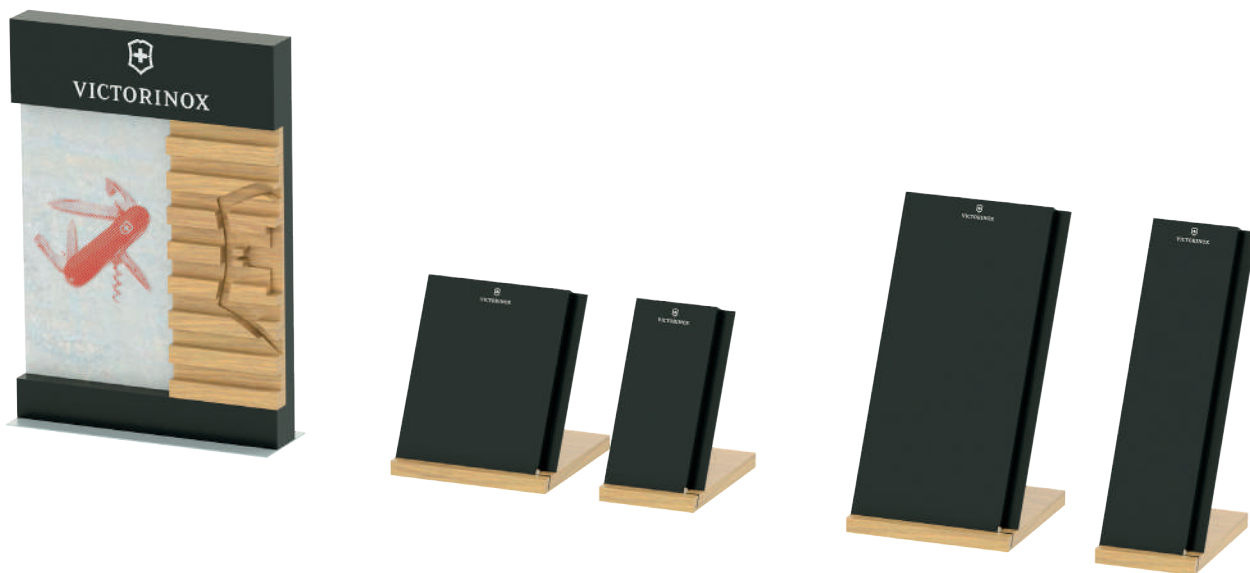

Large cutlery display stands set

▲ *Item no. 9.5321*

Backwall L350 x D110 x H500mm

Stands L120 x D200 x H364mm, L200 x D200 x H364mm, L200 x D200 x H219mm, L120 x D200 x H219mm

100 magnets ø7

COMPONENTS 1 Backwall L350 x W110 x H500mm, 1 graphic, Stands 1 L120 x W200 x H364mm, 1 L200 x W200 x H364mm,
1 L200 x W200 x H219mm, 1120 x W200 x H219mm, 100 magnets ø7

New display graphic

▲ *Item no. X.95321.01*



Small cutlery display stands set

- ◀ *Item no. 9.5320*
Small stand L120 x D200 x H219mm
Medium stand L200 x D200 x H219mm
50 magnets ø7

COMPONENTS 1 L120 x W200 x H219mm
1 L200 x W200 x H219mm
50 magnets ø7



Cutlery stand

- ◀ *Item no. 9.7007*
340 x 624mm



Cutlery display tray

- ◀ *Item no. 9.5316*
L432 x D175 x H160
-

3.0 SAK AND CUTLERY COMPONENTS

DISPLAYS



SAK tower

- ◀ *Item no. 9.6141.2 (german/english)*
 - ◀ *Item no. 9.6141.3 (french/english)*
- L320 x D320 x H1130mm**

COMPONENTS **Large rotating show case including internal storage space**



Rolling pillar for SAK tower

- ◀ *Item no. 9.6146*
- Ø75 x H740mm**
-



SAK cabinet

- ◀ *Item no. 9.6151*
L480 x D480 x H1960mm
-



SAK and cutlery frame for rotating tower

- ◀ *Item no. 9.6700.N*
L600 x D600 x H1990mm
-

3.0 SAK AND CUTLERY COMPONENTS

DISPLAY



SAK and cutlery wall tower

◀ *Item no. 9.6702.N*
L450 x D430 x H2060mm



Additional wall for SAK and Cutlery wall tower

◀ *Item no. 9.6703.N*
L450 x D430 x H2060mm



Wooden end frame for SAK and Cutlery wall towers

◀ *Item no. 9.6706.N*
L450 x D430 x H2060mm



Lockable showcase to display tower with storage room

◀ *Item no. 9.6709.N*
L400 x D195 x H780mm



Lockable showcase to display tower without storage room

◀ *Item no. 9.6710.N*
L400 x D195 x H780mm

3.0 SAK AND CUTLERY COMPONENTS

DISPLAYS & FURNITURE COMPONENTS



Magnetic board for rotating and wall towers

◀ *Item no. 9.6713.N*
L400 x H780mm



3 tray unit with 5 subdivisions for rotating and wall towers

◀ *Item no. 9.6715.N*
L400 x D250 x H780mm



German price tags for top tray

◀ *Item no. 9.6727.22*
40 x 80mm, sheet 210 x 297mm

French price tags for top tray

◀ *Item no. 9.6727.32*
40 x 80mm, sheet 210 x 297mm

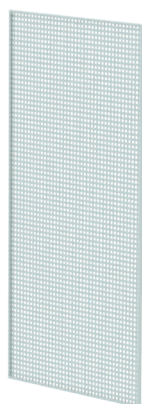

Perforated wall shelf to display tower

◀ *Item no. 9.6714.N*
L400 x H780mm

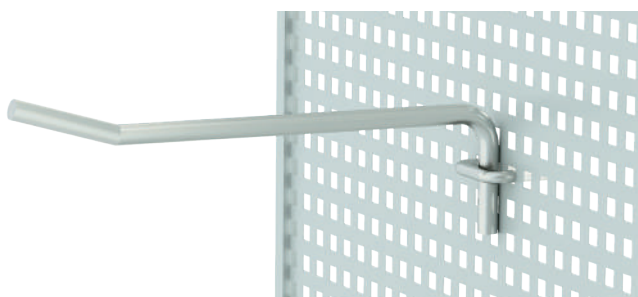

Pointed zinc plated hooks single, 150mm

◀ *Item no. 9.6722*
150mm long

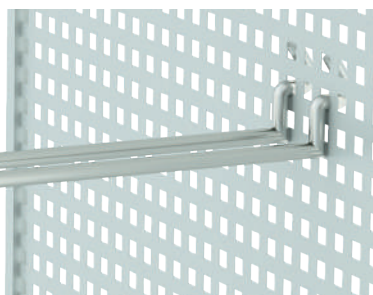

Double zinc plated hooks, 160mm

◀ *Item no. 9.6723*
160mm long



Perforated identity card for euro hanger

◀ *Item no. 9.7055*
42 x 158mm

3.0 SAK AND CUTLERY COMPONENTS

DISPLAY

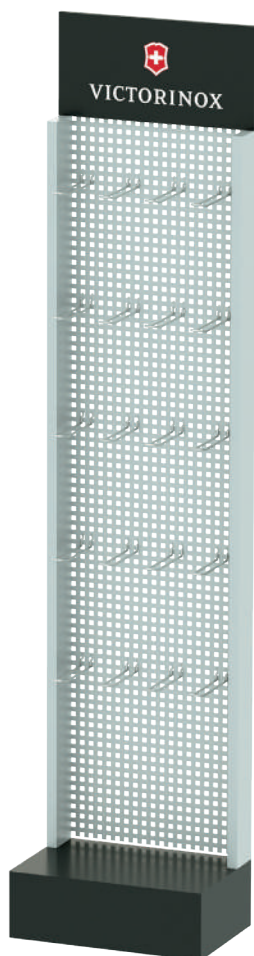

Small freestanding blister

◀ *Item no. 9.6155*

Double zinc plated blister hooks, 12cm

◀ *Item no. X.96155.01*

120mm long

Transparent shelf board

◀ *Item no. X.96155.02*

L394 x W234mm

Lock for blister hooks

◀ *Item no. X.96155.03*

L394 x W265 mm

COMPONENTS **20 blister hooks provided**

Tray with 4 subdivisions

◀ *Item no. X.96155.04*



Small magnets

◀ *Item no. 9.6138.04*

4mm



Medium magnets

◀ *Item no. 9.6138.07*

7mm



SAK spring repair kit

◀ *Item no. 9.6100*

L260 x W220 x H18mm

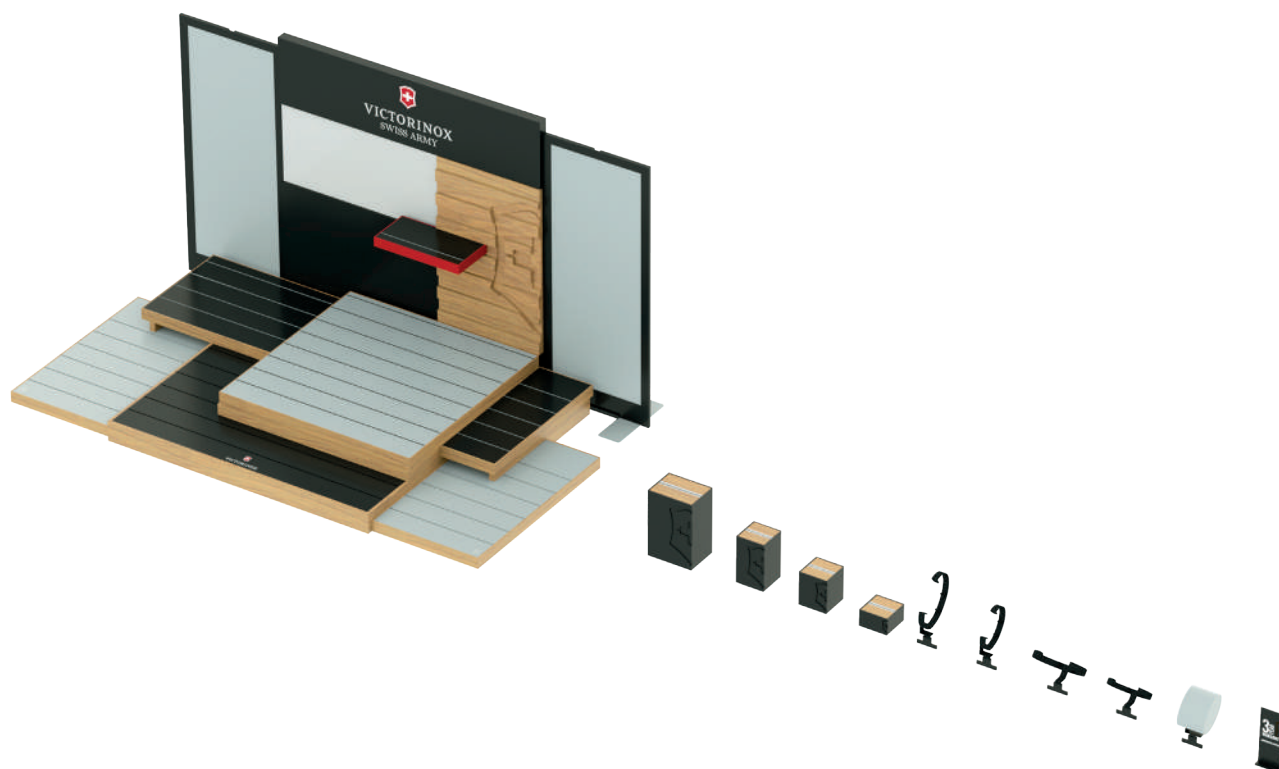

Watches large window display set

▲ *Item no. 9.5340.02*

Size extended L897 x D537 x H500mm

Size closed L500 x D437 x H500mm

COMPONENTS Removable picture holder – x 2, vertical c-ring large – x 27, vertical c-ring small – x 3, horizontal c-ring large – x 13, horizontal c-ring small – x 2, watch cube 80x60x120 – x 1, watch cube 50x50x85 – x 4, watch cube 50x50x60 – x 7, watch cube 50x50x30 – x 7, pillow – x 6, 3-year warranty and authorized dealer plate 1, SAK holder – x 1

NOTE Side graphics and Swiss Army Knife needs to be ordered separately.

Side graphics

▲ *Item no. 9.5340.0201*

Spartan Swiss Army Knife

▲ *Item no. 1.3603*

4.0 WATCH COMPONENTS

DISPLAY



XXL backboard for large watch window display set

◀ *Item no. 9.5340.03*

Size extended L897 x D190 x H700mm

Size closed L500 x D190 x H700mm

COMPONENTS	Backboard –x 1 Sides –x 2 Side wing visuals – x 2
NOTE	Side graphics needs to be ordered separately.

Side graphics

◀ *Item no. 9.5340.0301*



XXL backboard for large watch window display set incl. LCD screen

◀ *Item no. 9.5340.05*

Size extended L897 x D190 x H700mm

Size closed L500 x D190 x H700mm

COMPONENTS	Backboard –x 1 Sides –x 2 Monitor LCD screen x 1
NOTE	Side graphics and SD card needs to be ordered separately.

SD card

▲ *Item no. 9.5340.SD01*

Side graphics

▲ *Item no. 9.5340.0301*



Backboard with LCD screen for large watch windows display set

▲ *Item no. 9.5340.04*
L500 x D100 x H500mm

NOTE **SD card needs to be ordered separately.**

SD card

▲ *Item no. 9.5340.SD01*

4.0 WATCH COMPONENTS

DISPLAY

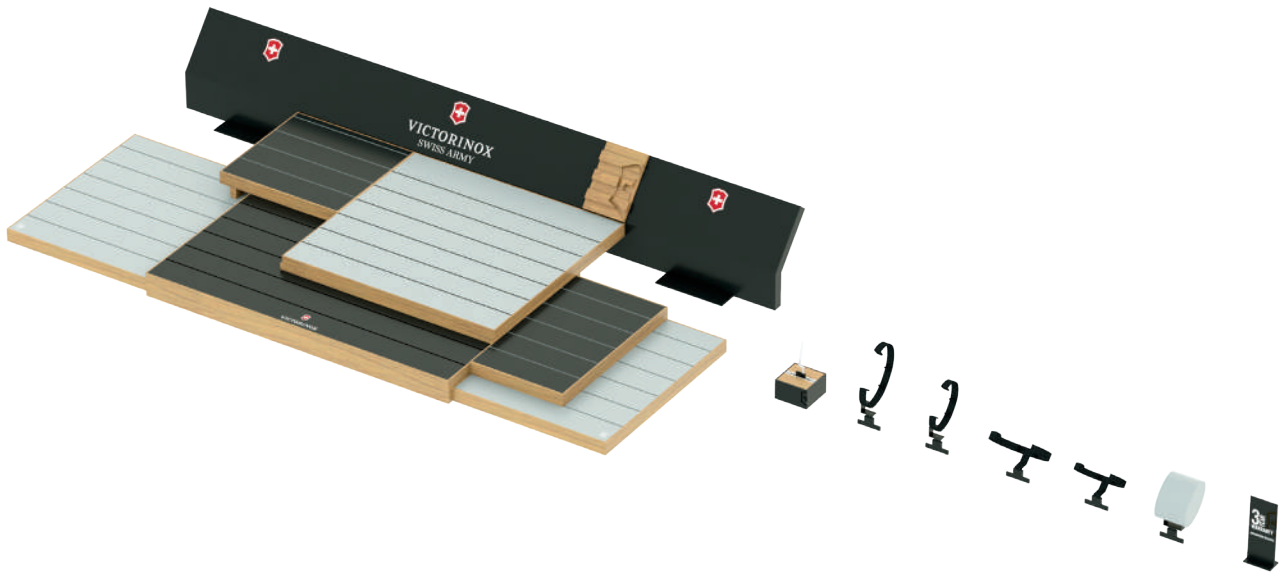

Small cabinet watch display set

▲ *Item no. 9.5341.01*

Size extended L878 x D453 x H157mm

Size closed L500 x D380 x H157mm

COMPONENTS Removable large backboard – x 1, removable small backboard – x 2, vertical c-ring large – x 30, vertical c-ring small – x 5, horizontal c-ring large – x 8, horizontal c-ring small – x 2, watch cube 50x50x30 – x 6, pillow – x 6, 3-year warranty and authorized dealer plate – x 1

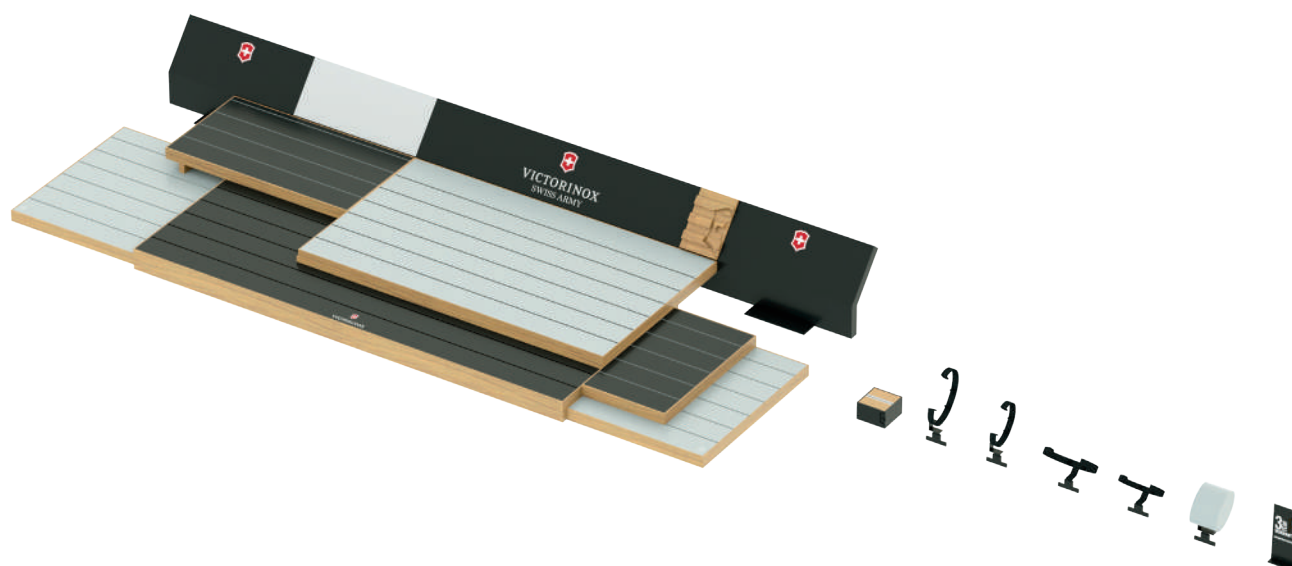

Large cabinet watch display set

▲ *Item no. 9.5341.02*

Size extended L1300 x D452 x H157mm

Size closed L800 x D380 x H157mm

COMPONENTS Removable backboard – x 1, removable small backboard – x 2, vertical c-ring large – x 30, vertical c-ring small – x 5, horizontal c-ring large – x 12, horizontal c-ring small – x 3, watch cube 50x50x30 – x 10, pillow – x 10, 3-year warranty and authorized dealer plate – x 1, SAK holder – x 1

NOTE Swiss Army Knife needs to be ordered separately.

Spartan Swiss Army Knife

▲ *Item no. 1.3603*
