



VICTORINOX

CORPORATE GIFTS





MORE THAN 125 YEARS OF TRADITION AND EXPERIENCE

Victorinox products have accompanied people through life's adventures since 1884. Precise and elegantly engineered, our company is proud to represent the distinguished characteristics of our country through the manufacturing of knives. They are one of the key symbols of excellent Swiss quality and ingenuity.

Still today, the core values upon which our business and manufacturing is based, are as relevant as they were in 1897 when Karl Elsener invented the Original Swiss Army Knife: Functionality, innovation, iconic design and uncompromising quality. Victorinox creates products which are designed to be true companions for life. They are the ambassadors of our timeless Swiss values – as timeless as the classics you will discover on the following pages.

Today Victorinox produces more than 100'000 Pocket Tools, Household- and Professional Knives per day. We market our products in 125 countries on all five continents and a considerable part thereof is used as Promotional Gifts. The typical values such as quality, innovation, functionality and iconic design leave a lasting impression and guarantee an unmistakable and lasting image transfer.

Our products are the result of the dedicated work of 2000 individuals who are part of the Victorinox family from around the world. It is the culmination of their contributions which make Victorinox products what they are: unique.

We are pleased to offer you in this catalog a carefully selected choice of favoured promotional products.

Victorinox

Carl Elsener

Carl Elsener

We guarantee all Victorinox Knives and Pocket Tools to be of first class stainless-steel and also guarantee a life time against any defects in material and workmanship. Damages caused by misuse or abuse are not covered by this guarantee. The guarantee for the electronic parts is, as worldwide usual, 2 years.

For further inDimensionsion please visit www.victorinox.com

SMALL POCKET KNIVES	page 6 – 11
MEDIUM POCKET KNIVES	page 12 – 21
LARGE POCKET KNIVES	page 22 – 27
SWISSTOOLS	page 28 – 31
SWISSCARDS	page 32 – 33
SPECIAL KNIVES & SETS	page 34 – 37
HOUSEHOLD KNIVES	page 38 – 45
PACKAGING & ACCESSORIES	page 46 – 49
INSCRIPTION ARTWORK & PRINT PROCESSES	page 50 – 53
FUNCTIONS & COLORS	page 54 – 58



SIZE OVERVIEW





105 MM



111 MM



115 MM



130 MM



SMALL POCKET KNIVES

The company logos printed herein are shown for demonstration purposes only and remain property of the respective company.

58 MM



0.6123 ESCORT
Length: 58 mm
6 Functions



0.6125 SCRIBE
Length: 58 mm
6 Functions



0.6163 RALLY
Length: 58 mm
9 Functions



TOP



0.6203 CLASSIC
Length: 58 mm
7 Functions



0.6223 CLASSIC SD
Length: 58 mm
7 Functions



TOP



0.6225 SIGNATURE
Length: 58 mm
7 Functions





SMALL POCKET KNIVES



0.6363 RAMBLER

Length: 58 mm

10 Functions



0.6365 MANAGER

Length: 58 mm

10 Functions



0.6385 MINICHAMP

Length: 58 mm

16 Functions



NEW

ALOX



0.6221.26 CLASSIC SD ALOX

Length: 58 mm

5 Functions

■ (Alox silver ribbed)



Imprint Area

USB



4.6125.TG VICTORINOX@WORK
 Length: 58 mm
 8 Functions



LITE



0.6226 SIGNATURE LITE
 Length: 58 mm
 7 Functions



0.6226.T7 SIGNATURE LITE SILVERTECH
 Length: 58 mm
 7 Functions



0.6228 SWISSLITE
 Length: 58 mm
 7 Functions



0.6366 MIDNITE MANAGER
 Length: 58 mm
 10 Functions





SMALL POCKET KNIVES

65 MM



0.6421.63 EVOWOOD 81
Length: 65 mm
5 Functions



NEW



0.6461.63 NAILCLIP WOOD 580
Length: 65 mm
6 Functions



NEW



0.6453 NAILCLIP 582
Length: 65 mm
4 Functions



NEW



0.6463 NAILCLIP 580
Length: 65 mm
8 Functions



NEW

STANDARD PACKAGING



BOX WITH FOLDING FLAPS

silver, included in the price for:
0.6123, 0.6163, 0.6203, 0.6221.26, 0.6223, 0.6363



BOX WITH FOLDING FLAPS

silver, included in the price for:
0.6421.63, 0.6453, 0.6461.63, 0.6463



GIFT BOX

silver, included in the price for:
0.6125, 0.6225, 0.6226, 0.6226.T7, 0.6228,
0.6365, 0.6366, 0.6385, 4.6125.TG



91
85
84



0

MEDIUM POCKET KNIVES



The company logos printed herein are shown for demonstration purposes only and remain property of the respective company.

84 MM



0.2303 BANTAM
Length: 84 mm
8 Functions



0.2363 MY FIRST VICTORINOX
Length: 84 mm
8 Functions



0.2373 MY FIRST VICTORINOX
Length: 84 mm
9 Functions



0.3303 WAITER
Length: 84 mm
9 Functions



0.3603 TOURIST
Length: 84 mm
12 Functions



0.3803 SPORTSMAN
Length: 84 mm
13 Functions





MEDIUM POCKET KNIVES

ALOX



0.2300.26 ALOX BANTAM
 Length: 84 mm
 5 Functions
 ■ (Alox silver ribbed)



0.2601.26 CADET
 Length: 84 mm
 9 Functions
 ■ (Alox silver ribbed)

85 MM



2.3803.C EVOGRIP 10
 Length: 85 mm
 13 Functions
 ■ ■ ■
NEW



2.3803.E EVOLUTION 10
 Length: 85 mm
 13 Functions
 ■ ■
NEW



2.3801.63 EVOWOOD 10
 Length: 85 mm
 11 Functions
 ■
NEW



2.3911.63 EVOWOOD 17
 Length: 85 mm
 13 Functions
 ■
NEW



2.3913.E EVOLUTION 17
 Length: 85 mm
 15 Functions

NEW



2.4903.C EVOGRIP 16
 Length: 85 mm
 14 Functions

NEW

85 MM, WITH LARGE LOCK BLADE



2.3603.SC EVOGRIP S101
 Length: 85 mm
 12 Functions

NEW



2.3603.SE EVOLUTION S101
 Length: 85 mm
 12 Functions

NEW



2.3903.SE EVOLUTION S14
 Length: 85 mm
 14 Functions

NEW



2.3913.SC EVOGRIP S17
 Length: 85 mm
 15 Functions

NEW



MEDIUM POCKET KNIVES



2.4913.SC EVOGRIP S18
Length: 85 mm
15 Functions



NEW



2.5223.SC EVOGRIP S557
Length: 85 mm
21 Functions



NEW

91 MM



1.3603 SPARTAN
Length: 91 mm
12 Functions



TOP



1.3603.T7 SPARTAN SILVERTECH
Length: 91 mm
12 Functions



1.3613 CAMPER
Length: 91 mm
13 Functions



1.3703 CLIMBER
Length: 91 mm
14 Functions





1.3713 HUNTSMAN
 Length: 91 mm
 15 Functions

TOP



1.3743 MOUNTAINEER
 Length: 91 mm
 18 Functions





1.3763 RANGER
 Length: 91 mm
 21 Functions





1.4603 TINKER
 Length: 91 mm
 12 Functions



1.4613 HIKER
 Length: 91 mm
 13 Functions



1.4723 DELUXE TINKER
 Length: 91 mm
 17 Functions



MEDIUM POCKET KNIVES



1.6703 EXPLORER

Length: 91 mm

16 Functions



1.6795 SWISSCHAMP

Length: 91 mm

33 Functions



CYBERTOOL



1.7605 CYBERTOOL 29

Length: 91 mm

29 Functions



1.7725 CYBERTOOL 34

Length: 91 mm

34 Functions



TRAVELLER



1.3705.AVT TRAVELLER
 Length: 91 mm
 25 Functions
 (transparent mat)



1.7905.AVT TRAVELLER LITE
 Length: 91 mm
 27 Functions
 (transparent mat)



Digital clock
 24 h/12 h am/pm



Altimeter m/feet

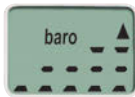

Barometer



Alarm



Countdown



Timer



Thermometer
 °C/°F

LITE



1.7804 SPARTAN LITE
 Length: 91 mm
 15 Functions



1.7915 HUNTSMAN LITE
 Length: 91 mm
 21 Functions



MEDIUM POCKET KNIVES

STANDARD PACKAGING



BOX WITH FOLDING FLAPS

silver, included in the price for:
0.2300.26, 0.2303, 0.2601.26, 0.3303, 0.3603,
0.3803, 1.3603, 1.3603.T7, 1.3613, 1.3703, 1.3713,
1.3743, 1.3763, 1.4603, 1.4613, 1.4723, 1.6703,
1.7804, 2.3803.C, 2.3803.E, 2.3801.63, 2.3911.63,
2.3913.E, 2.4903.C, 2.3603.SC, 2.3603.SE, 2.3903.SE,
2.3913.SC, 2.4913.SC, 2.5223.SC,



GIFT BOX

silver, included in the price for:
1.3705.AVT, 1.6795, 1.7605, 1.7725,
1.7905.AVT, 1.7915



SPECIAL PACKAGING WITH SEE-THROUGH WINDOW

with chain and neckstrap
included in the price for:
0.2363, 0.2373

MEDIUM POCKET KNIVES



84 / 85 / 91 MM



130
111
0



LARGE POCKET KNIVES

The company logos printed herein are shown for demonstration purposes only and remain property of the respective company.

111 MM



0.8413 SENTINEL
 Length: 111 mm
 4 Functions with liner-lock

NEW



0.8353 NOMAD
 Length: 111 mm
 11 Functions with liner-lock

TOP



0.8363 FORESTER
 Length: 111 mm
 12 Functions with liner-lock





0.8833.W CHEESE KNIFE
 Length: 111 mm
 6 Functions with lock release on the backside

NEW



0.9023 OUTRIDER
 Length: 111 mm
 14 Functions with lock release on the backside



0.9064 WORKCHAMP
 Length: 111 mm
 21 Functions with lock release on the backside



LARGE POCKET KNIVES

111 MM



0.8341.MC9 HUNTER XT
Length: 111 mm
6 Functions with liner-lock



0.8351.C NOMAD 2C
Length: 111 mm
9 Functions with liner-lock



0.8361.C FORESTER 2C
Length: 111 mm
10 Functions with liner-lock

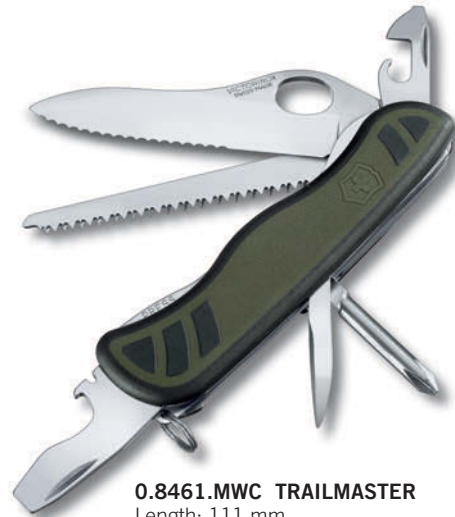

0.8461.MWC TRAILMASTER
Length: 111 mm
10 Functions with liner-lock
Swiss Soldier Knife



RESCUE TOOL



0.8623.N RESCUE TOOL
Length: 111 mm
15 Functions with liner-lock

(luminescent mat)



0.8623.MWN RESCUE TOOL
Length: 111 mm
15 Functions with liner-lock

(luminescent mat)



SPARE PARTS



STANDARD-PACKAGING
included in the price

130 MM



0.9523.C RANGERGRIP 52
Length: 130 mm
5 Functions with lock release on the frontside

NEW



0.9553.C RANGERGRIP 68
Length: 130 mm
11 Functions with lock release on the frontside

NEW



0.9561.63 RANGERWOOD 55
Length: 130 mm
10 Functions with lock release on the frontside

NEW



0.9563.C RANGERGRIP 55
Length: 130 mm
12 Functions with lock release on the frontside

NEW



0.9623.C RANGERGRIP 53
Length: 130 mm
5 Functions with lock release on the frontside

NEW



0.9663.C RANGERGRIP 56
Length: 130 mm
12 Functions with lock release on the frontside

NEW



LARGE POCKET KNIVES



0.9723.C RANGERGRIP 74
Length: 130 mm
14 Functions with lock release on the frontside



0.9728.WC RANGERGRIP 174 HANDYMAN
Length: 130 mm
17 Functions with lock release on the frontside



STANDARD-PACKAGING
included in the price

HUNTERPRO



0.9410 HUNTERPRO
Length: 130 mm
1 Function with Lockback



STANDARD-PACKAGING
included in the price

STANDARD PACKAGING



BOX WITH FOLDING FLAPS
silver, included in the price for:
0.8353, 0.8363, 0.8413, 0.8341.MC9, 0.8351.C,
0.8361.C, 0.8461.MWC, 0.8833.W, 0.9023,
0.9064, 0.9523.C, 0.9553.C, 0.9561.63, 0.9563.C,
0.9623.C, 0.9663.C, 0.9723.C

SLIDE BOX
silver, included in the price for:
0.8623.N, 0.8623.MWN,
0.9410

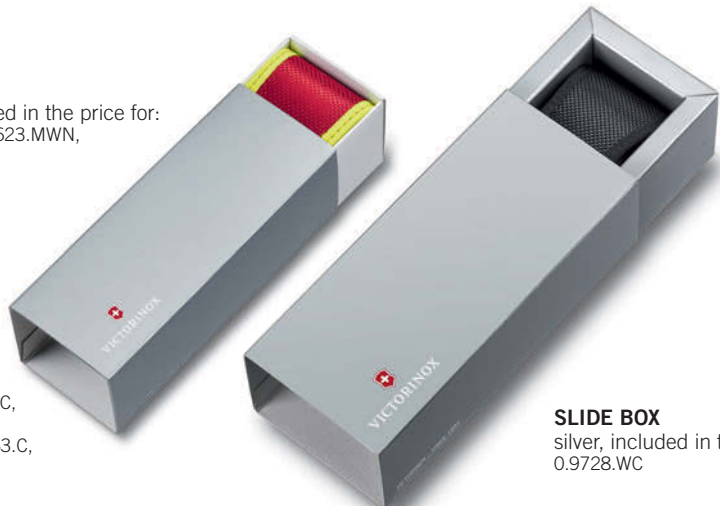

SLIDE BOX
silver, included in the price for:
0.9728.WC



115

105

0



SWISSTOOLS

The company logos printed herein are shown for demonstration purposes only and remain property of the respective company.



3.0224.L/N SWISSTOOL SPIRIT
 Length: 105 mm
 27 Functions
 (with pointed blade and straight cut)
 ■ (Stainless steel)



3.0227.L/N SWISSTOOL SPIRIT
 Length: 105 mm
 27 Functions
 ■ (Stainless steel)

TOP



3.0238.L/N SWISSTOOL SPIRIT PLUS
 Length: 105 mm
 38 Functions (with bit wrench)
 ■ (Stainless steel)



3.0239.L/N SWISSTOOL SPIRIT PLUS
 Length: 105 mm
 39 Functions (with ratchet and extension bar)
 ■ (Stainless steel)

STANDARD PACKAGING

LEATHER POUCH

4.0822.L
 included in the price



NYLON POUCH

4.0822.N
 included in the price



SLIDE BOX

silver, included in the price



SWISSTOOLS



3.0323.L/N SWISSTOOL
Length: 115 mm
27 Functions
(with wavy cut blade instead of scissors)
■ (Stainless steel)



3.0327.L/N SWISSTOOL
Length: 115 mm
27 Functions
■ (Stainless steel)



3.0338.L/N SWISSTOOL PLUS
Length: 115 mm
38 Functions (with bit wrench)
■ (Stainless steel)



3.0339.L/N SWISSTOOL PLUS
Length: 115 mm
39 Functions (with ratchet and extension bar)
■ (Stainless steel)

STANDARD PACKAGING



LEATHER POUCH
4.0523.3
included in the price

NYLON POUCH
4.0823.N
included in the price



SLIDE BOX
silver, included in the price





82



SWISSCARDS

The company logos printed herein are shown for demonstration purposes only and remain property of the respective company.

0.71... SWISSCARD CLASSIC
 Dimensions: 82 x 54 x 4 mm
 10 Functions



TOP



0.72... SWISSCARD QUATTRO
 Dimensions: 82 x 54 x 4 mm
 12 Functions



0.7240 SWISSCARD NAILCARE
 Dimensions: 82 x 54 x 4 mm
 13 Functions



NEW



0.73... SWISSCARD LITE
 Dimensions: 82 x 54 x 4 mm
 13 Functions



STANDARD PACKAGING



FOLDABLE CARDBOARD BOX
 silver, included in the price
 bei 0.71..., 0.72..., 0.73..



SLIDE BOX
 silver, included in the price
 for 0.7240



SPECIAL KNIVES & SETS

The company logos printed herein are shown for demonstration purposes only and remain property of the respective company.

BIKE TOOL



4.1329 BIKE TOOL
 Length: 100 mm
 12 Functions
NEW



BOX WITH FOLDING FLAPS
 silver, included in the price

CIGAR CUTTER



0.6580.16 CIGAR CUTTER
 Length: 74 mm
 5 Functions
 (Alox silver)



GIFT BOX
 silver, included in the price

GOLFTOOL



0.7052 GOLF TOOL
 Length: 91 mm
 10 Functions



GIFT BOX
 silver, included in the price



CABRIO PEN SETS



4.4341.2/3 CABRIO PEN SET
Roller ball pen with aluminum piston and red Classic SD pocket knife available with blue or black ink



4.4343.2/3 CABRIO PEN SET
with black Classic SD pocket knife



4.4346.2/3 CABRIO PEN SET
with Alox Classic SD pocket knife



PAPERFOAM PACKAGING
red-white, included in the price

MAGLITE SETS



4.4014 MAGLITE SET SOLITAIRE LED
Classic SD pocket knife with Maglite LED flashlight 8 cm



4.4024 MINI MAGLITE SET AAA LED
Classic SD pocket knife with Maglite LED flashlight 12.5 cm





SWISS CLASSIC



The company logos printed herein are shown for demonstration purposes only and remain property of the respective company.

6.7233 STEAK KNIFE small with wavy edge
Blade length: 11 cm



6.740... PARING KNIFE
6.743... PARING KNIFE with wavy edge
Blade length: 8 cm



6.750... SHAPING KNIFE
Blade length: 6 cm



6.760... PARING KNIFE
6.763... PARING KNIFE with wavy edge
Blade length: 8 cm



6.770... PARING KNIFE
Blade length: 10 cm



6.773... PARING KNIFE with wavy edge
Blade length: 10 cm



6.783... TOMATO AND SAUSAGE KNIFE with wavy edge
Blade length: 11 cm



TOP



6.7903.12 STEAK KNIFE
6.7933.12 STEAK KNIFE / PIZZA KNIFE with wavy edge
Blade length: 12 cm



ETCHING: Above 280 units at discretion (with blade protection), below 280 units standard etching Victorinox (without blade protection and with surcharge). Minimum order quantity 100 units.



6.8003.15 OFFICE KNIFE
Blade length: 15 cm



6.800..19 CARVING KNIFE
Blade length: 19 cm



TOP

6.8003.22/25 CARVING KNIFE
Blade length: 22/25 cm



6.8223.25 SLICING KNIFE with fluted edge
Blade length: 25 cm



6.8413.15 BONING KNIFE
Blade length: 15 cm





6.8503.17 SANTOKU KNIFE

Blade length: 17 cm



6.852..17 SANTOKU KNIFE with fluted edge

Blade length: 17 cm



6.863..21 BREAD KNIFE with wavy edge

Blade length: 21 cm



6.8633.26 PASTRY KNIFE with wavy edge

Blade length: 26 cm



6.8713.20 FILLET KNIFE with flexible blade

Blade length: 20 cm





6.7173.8 CUTLERY BLOCK 8 PIECES
Contains the following knives:
6.7233, 6.7433, 6.7603, 6.7703,
6.7833, 6.8003.19, 6.8523.17, 6.8633.21



7.7043 CUTLERY BLOCK EMPTY,
Nylon inlay for individual assembly



7.7033 CUTLERY BLOCK PLASTIC
with nylon inlay for individual assembly



NEW



STANDARD PACKAGING



BOX WITH FOLDING FLAPS
silver, included in the price for:
6.7173.8



BOX WITH FOLDING FLAPS
silver, included in the price for:
7.7033

PACKAGING / SETS



4.0021
GIFT BOX



FOR HOUSEHOLD KNIVES SMALL (page 39)

The following knives can be boxed: (1 piece)
6.7233 / 6.740... / 6.743... / 6.750... / 6.760... / 6.763... / 6.770... / 6.773... / 6.783... / 6.7903.12 / 6.7933.12



.....G
GIFT BOX



FOR HOUSEHOLD KNIVES LARGE (page 40–41)

The following knives can be boxed: (1 piece)
6.8003.15 / 6.800..19 / 6.8003.22 / 6.8003.25 / 6.8223.25 / 6.8413.15 / 6.8503.17 / 6.852..17 / 6.863..21 / 6.8633.26 / 6.8713.20



4.0022
PLASTIC BOX



FOR HOUSEHOLD KNIVES SMALL (page 39)

The following knives can be boxed: (2–4 pieces)
6.7233 / 6.740... / 6.743... / 6.750... / 6.760... / 6.763... / 6.770... / 6.773... / 6.783... / 6.7903.12 / 6.7933.12



4.0023
SET OF 3 SMALL



FOR HOUSEHOLD KNIVES SMALL (page 39)

The following knives can be boxed: (3 pieces)
6.7233 / 6.740... / 6.743... / 6.750... / 6.760... / 6.763... / 6.770... / 6.773... / 6.783...



PACKAGING / SETS



4.0024.1
SET OF 2

FOR HOUSEHOLD KNIVES LARGE (page 40–41)

The following knives can be boxed: (2 pieces)

6.8003.15 / 6.800..19 / 6.8003.22 / 6.8503.17 / 6.852..17 / 6.863..21 / 6.8713.20

BANDEROLE

white, individually printable



4.0024.2
SET OF 3 LARGE

FOR HOUSEHOLD KNIVES SMALL (2 pieces.) + **LARGE** (1 piece) (page 39–41)

The following knives can be boxed: (3 pieces.)

Small: 6.7233 / 6.740... / 6.743... / 6.750... / 6.760... / 6.763... / 6.770... / 6.773... / 6.783...
Large: 6.8003.15 / 6.800..19 / 6.8003.22 / 6.8503.17 / 6.852..17 / 6.863..21 / 6.8713.20



PACKAGING & ACCESSORIES



The company logos printed herein are shown for demonstration purposes only and remain property of the respective company.

PACKAGING



4.0..... GIFT BOX
silver, for 58 mm, 84 mm, 91 mm
and 111 mm Swiss Army Knife



4.0...17 GIFT BOX
with see-through sliding cover, for 58 mm, 84 mm
and 91 mm Swiss Army Knife

NEW



4.0137.17 BOX WITH FOLDING FLAPS
darkgrey, with see-through window, on both sides
for 91 mm pocket knife

NEW



4.0289.1/2/3/4 GIFT BOX
silver, for 58 mm, 91 mm to
5 layers or 6–7 layers and
111 mm Knives up to 4 layers

BANDEROLE
white, individually printable



POUCHES



4.0520.1 / 4.0521.1 BELT POUCH
Leather red with press button
for 91 mm Swiss Army Knives 2-4 or 5-8 layers



4.0520.3 / 4.0521.3 BELT POUCH
Leather black with hook-and-loop fastener
for 91 mm Swiss Army Knives 2-4 or 5-8 layers



4.0523.3 / 4.0524.3 BELT POUCH
Leather black with hook-and-loop fastener
for 111 mm blade knives 2-4 layers or 5-6 layers
and SwissTool



4.0523.31 BELT POUCH
Leather black with rotating metal belt clip
for 111 mm blade knives 2-4 layers
including SwissTool



4.0636 - 4.0740 LEATHER POUCH
black, red pocket flap
for 58 mm, 84 mm und 91 mm Swiss Army Knives, 1-7 layers



4.0822.L1 BELT POUCH
Leather brown with rotating metal belt clip
for SwissTool Spirit





4.0822.4 BELT POUCH
Synthetic green
for lock blade knives up to 4 layers
and the SwissTool Spirit



4.0853 GOLFTOOL POUCH
Leather black with belt clip and pencil



4.0873.L / 4.0873.V SWISSCARD POUCH
Leather black (rough grained)
Leather imitation black (fine grained)



4.1853 BELT HANGER
Leather black, length 7 cm with snap hook
and split-ring



4.1879 VICTORINOX NECK STRAP





INSCRIPTION ARTWORK & PRINT PROCESSES

The company logos printed herein are shown for demonstration purposes only and remain property of the respective company.



INSCRIPTION ARTWORK

Electronic files:

Artwork for company logos

Fonts must be converted to paths. The colors must be defined precisely with Pantone, RAL or HKS numbers.



Adobe Acrobat



eps file



Adobe Illustrator

Image files for photographic prints

The resolution of the image file must be 300 dpi and provided full size (1:1). The file may be in RGB or CMYK color space.



tif file



jpg file



Adobe Photoshop

Design suggestions

Design suggestions may be produced in Adobe Acrobat and Adobe InDesign, but they must be specially prepared for tamponprinting.



Adobe Acrobat



Adobe InDesign

Sample Proof 1:1

On various products we are able to send you a 1:1 color PDF print proof including the print surfaces.

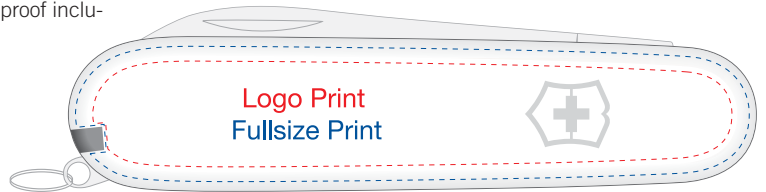

PRINT PROCESSES

TAMPONPRINT

Today over 90 % of all imprinting orders at Victorinox are executed with Tamponprint. On the one hand we make use of spot color imprinting with up to six colors and, on the other hand, we do photo prints (CMYK); in any case your CI will be reproduced to the highest level of conformity. In both procedures color is extracted with an elastic stamp from a steel plate, where the image is etched-in, and is then transferred to the object to be printed.

Applicable on: 58 mm-/65 mm-/84 mm-/85 mm-/91 mm-/111 mm- / SwissCards-scales

Exceptions: Wood / EvoGrip / SilverTech

Protective lacquer

All Tamponprints applied on Cellidor scales are protected with a high gloss lacquer. Thanks to this hard lacquer the prints are highly resistant to abrasion and chemical substances. This process is environmentally friendly and the lacquer is food safe. The protective lacquer increases the abrasion of the prints by > 100.

Applicable on: Cellidor brilliant

Exceptions: scales including ballpoint pen or LED switch, Evolution



ETCHING

The perfect method to decorate steel parts durably. The inscription occurs through electrolytic oxidation (electrolyte and etching current). The refining appears in anthracite/dark grey and excels with long durability.

Applicable on: Steel (blades and scales SwissTool)





METAL INLAY

The logos and inscriptions are created photochemically and then flush pressed with high temperature into the scales. This method excels with a long durability and a high class appearance.

Applicable on: 58 mm- / 84 mm- / 91 mm-scales (only front side)
Exceptions : transparent scales / scales with LED switch



HOT STAMPING

Stamping a motif to a certain depth is done with the help of a brass stamp, stamping transfer foil, heat and pressure. Suitable for 1-color reproduction of simple logos, narrow fonts and numbers in silver, white, gold, blue, red, black or green (standard colors only). For small quantities 5 standard fonts are available (see illustration) without die costs.

Applicable on: 58 mm- / 84 mm- / 91 mm- / 111 mm-scales
Exceptions: scales with LED or ballpoint pen / SilverTech

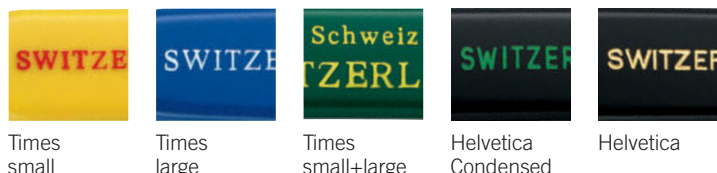

ENGRAVING

A tool cuts the font into the material. On plastic surfaces the engraving cavity is then filled with a contrasting color. For diamond engraving on the SwissTool logos and inscriptions are also possible. They appear contour (see illustration). Suitable for small runs or individual names in the standard fonts as marked below.

Applicable on: 58 mm- / 65 mm- / 84 mm- / 85 mm- / 91 mm- / 111 mm-scales and steel
Exceptions: scales with LED / SilverTech / Wood / EvoGrip / RangerGrip / 2-component scales



LASER ENGRAVING

Laser engraving is suitable for a range of surfaces. On wood or rubber it develops a depth effect and is therefore also haptically perceptible. On metal the engraving appears in anthracite/gray and features high wear resistance.

Applicable on: EvoWood, EvoGrip, RangerGrip, Cabrio Pen Roller Ball and MagLite Flash Lights



IMPRINT ON ALOX SCALES

A silicone rubber stamp is used to transfer ink from the engraved steel printing block to chemically treated hence microscopically porous handle. The surface is then sealed and the ink particles become enclosed in a wafer-thin anodized layer making it scratch and impact resistant. Color fidelity limited. Imprint area on back side.

Applicable on: Alox scales







**FUNCTIONS
& COLORS**

Soldatenmesser Modell 1890.

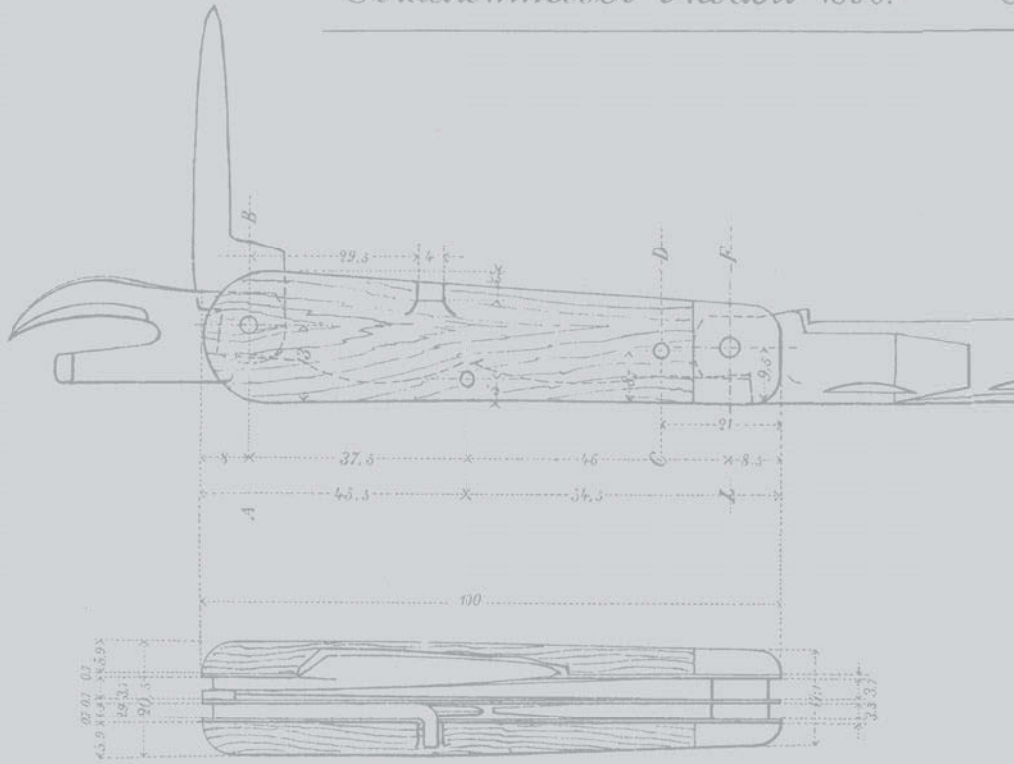

Büchsenöffner.

Couteau pour ouvrir les boîtes à conserve.

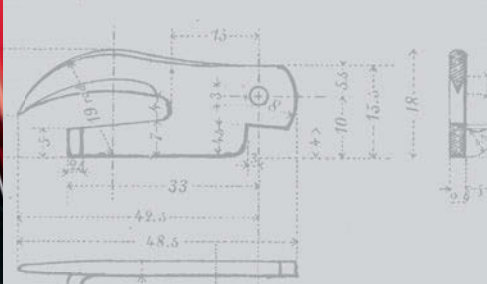

Klinge.

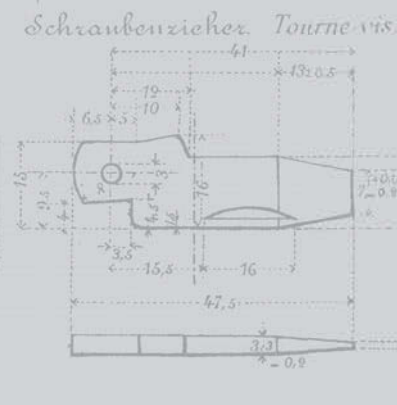
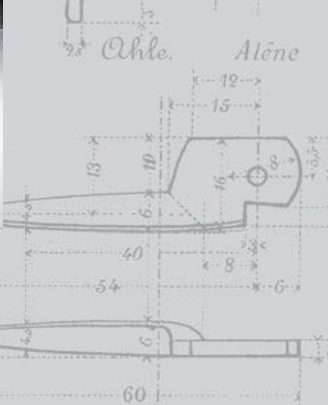
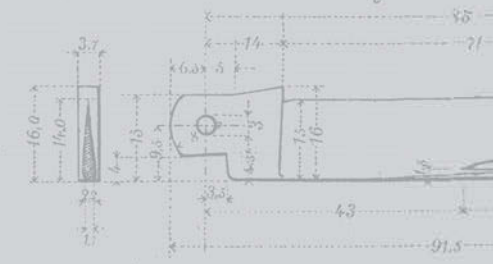

Toleranzen

Gegenstand.	Objet.	Dicke Epaisseur
Klingen	Lames	± 0.2
Federn	Ressorts	± 0.5
Plattinen	Platines	± 0.1
Fertiges Messer	Couteau fini	± 0.1
Nieten	Rivets	± 0.1
Zwischenlage	Entredeux	± 0.3

Alle Einzelbestandteile sind vor dem Zusammenstellen ihren Dimensionen entsprechend zu überprüfen, dass das fertige Messer korrekt funktioniert.

SMALL POCKET KNIVES



1. blade
2. nailfile with
3. – nail cleaner
4. scissors
5. key ring
6. tweezers
7. toothpick
8. nailfile with
9. – screwdriver
10. caplifter with
11. – magnet. Phillips screwdriver
12. – wire stripper
13. bright LED
14. ballpoint pen
15. USB drive
16. serrated edge scissors and lever
17. nail clipper

MEDIUM POCKET KNIVES

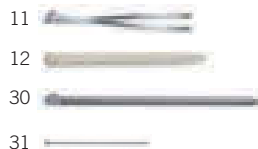

1. large blade
2. small blade
3. cork screw
4. can opener with
5. – small screwdriver
6. cap lifter with
7. – screwdriver
8. – wire stripper
9. reamer, punch
10. key ring
11. tweezers
12. toothpick
13. scissors
14. multi-purpose hook
15. wood saw
16. fish scaler with
17. – hook disgorger
18. – ruler (cm + inches)
19. nailfile with
20. – metal file
21. – nail cleaner
22. metal saw
23. screwdriver 2.5 mm
24. chisel and scraper
25. pliers with
26. – wire cutters
27. – wire crimping tool
28. Phillips screwdriver
29. magnifying glass
30. pressurized ballpoint pen
31. pin, stainless steel
32. mini-screwdriver
33. sewing eye
34. wrench with
35. – Hex drive 5 mm
36. – Hex drive 4 mm for the bits
37. case with 6 bits
(bit slotted 4 mm,
bit Phillips 2, bit hex 4 mm,
bit Torx 8/10/15)
38. Digital clock 12h/24h
39. – Alarm
40. – Countdown
41. – Timer
42. Altimeter m/feet
43. Barometer
44. Thermometer
45. LED
46. serrated edge scissors and lever
47. pliers with
48. – shifting opening
49. – wire crimping tool
50. – wire cutters
51. – nut wrench
52. universal wrench
combination tool:
53. – caplifter
54. – can opener
55. – screwdriver
56. – wire stripper

LARGE POCKET KNIVES



- | | |
|-------------------------------------|----------------------------|
| 1. large lock blade | 29. cheese blade |
| 2. cork screw | 30. large lock blade |
| 3. can opener with | $\frac{2}{3}$ wavy edge |
| 4. – screw driver | 31. needlenose pliers with |
| 5. cap lifter with | 32. – wire cutter |
| 6. – screw driver | 33. – nut wrench |
| 7. – wire stripper | 34. bit holder |
| 8. reamer, punch | 35. – bit Phillips 3 |
| 9. keyring | 36. – bit for slotted head |
| 10. tweezers | 0.6 x 4.5 mm |
| 11. toothpick | (Hunter XT: gutting blade) |
| 12. wood saw | |
| 13. scissors | |
| 14. long small Phillips screwdriver | |
| 15. metal saw with | |
| 16. – metal file | |
| 17. pliers with | |
| 18. – wire cutters | |
| 19. – wire crimping tool | |
| 20. Phillips screwdriver 1-2 | |
| 21. mini-screwdriver | |
| 22. lock blade for one hand | |
| opening with $\frac{2}{3}$ wavy cut | |
| 23. Phillips screwdriver | |
| 24. window breaker | |
| 25. lockable crate opener | |
| 26. seatbelt cutter | |
| 27. saw for shatterproof glass | |
| 28. Nylon cord | |
| (Hunter XT: gutting blade) | |

SWISSTOOLS

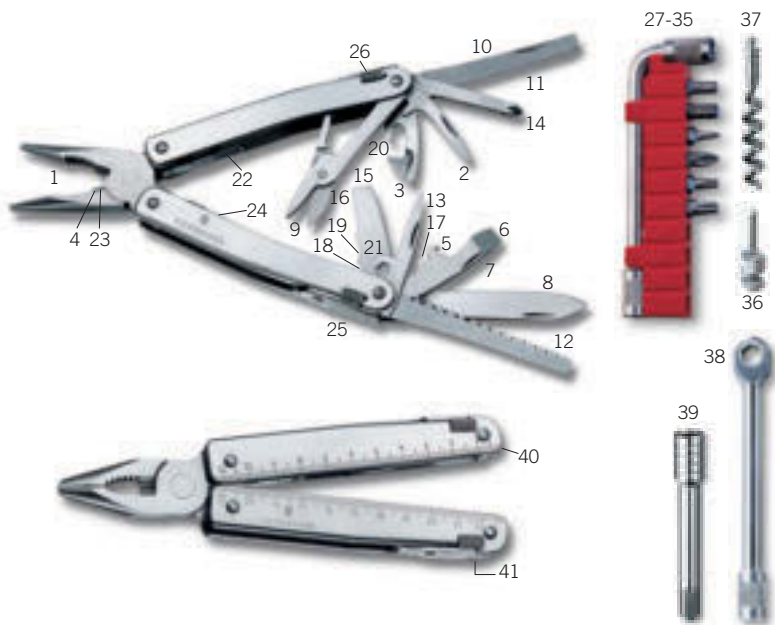

- | | |
|-----------------------------------|-------------------------------|
| 1. needlenose pliers | 22. coupling for corkscrew |
| 2. screwdriver 2 mm | 23. hard wire cutter |
| 3. screwdriver 3 mm | 24. lanyard hole |
| 4. wire cutter for thin | 25. ten individual springs |
| and soft wire up to 40 HRc | 26. lock release |
| 5. cap lifter | 27. case |
| 6. screwdriver 6 mm | 28. bitwrench |
| 7. crate opener | 29. – bit Hex 3 |
| 8. blade | 30. – bit Hex 4 |
| 9. scissors | 31. – bit Phillips 0 |
| 10. metal file | 32. – bit Phillips 3 |
| 11. metal saw | 33. – bit Torx 10 |
| 12. wood saw | 34. – bit Torx 15 |
| 13. reamer and punch | 35. space for additional bits |
| 14. Phillips screwdriver 1+2 | 36. mini-screwdriver |
| 15. chisel/scrapper | 37. corkscrew |
| 16. cable cover cutter lengthwise | 38. ratchet (30 Nm) |
| 17. wire bender | (instead of bitwrench) |
| 18. wire stripper and scraper | 39. extension bar |
| 19. cable cover cutter circular | 40. ruler (230 mm) |
| 20. can opener | 41. ruler (9 Zoll) |
| 21. multi purpose hook | |

SWISSCARDS

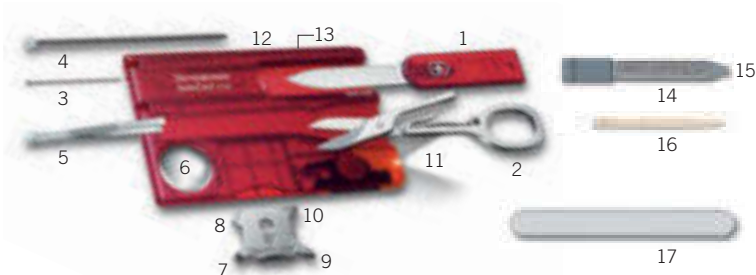

- | | |
|------------------------------|--------------------|
| 1. letter opener (blade) | 11. LED |
| 2. scissors | 12. ruler (cm) |
| 3. pin, stainless steel | 13. ruler (inches) |
| 4. pressurized ballpoint pen | 14. nailfile with |
| 5. tweezers | 15. – screw driver |
| 6. magnifying glass | 16. toothpick |
| 7. screwdriver 3 mm | 17. glass nailfile |
| 8. screwdriver 5 mm | |
| 9. Phillips screwdriver 00-0 | |
| 10. Phillips screwdriver 1-2 | |

Pantone approximate values



187c

288c

3308c

116c

Pantone approximate values



187c

288c

3308c

116c

Pantone approximate values



188c

280c

