

> Features

- High Current
- Low On-Resistance
- No Secondary Breakdown
- Low Driving Power
- High Forward Transconductance

> Applications

- Motor Control
- General Purpose Power Amplifier
- DC-DC converters

> Outline Drawing

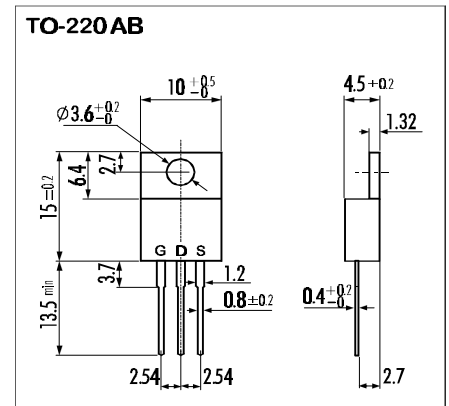

> Maximum Ratings and Characteristics

- Absolute Maximum Ratings (T_C=25°C), unless otherwise specified

Item	Symbol	Rating	Unit
Drain-Source-Voltage	V _{DS}	60	V
Drain-Gate-Voltage (R _{GS} =20KΩ)	V _{DGR}	60	V
Continous Drain Current	I _D	50	A
Pulsed Drain Current	I _{D(puls)}	200	A
Gate-Source-Voltage	V _{GS}	±20	V
Max. Power Dissipation	P _D	80	W
Operating and Storage Temperature Range	T _{ch}	150	°C
	T _{stg}	-55 ~ +150	°C

> Equivalent Circuit



- Electrical Characteristics (T_C=25°C), unless otherwise specified

Item	Symbol	Test conditions	Min.	Typ.	Max.	Unit
Drain-Source Breakdown-Voltage	V _{(BR)DSS}	I _D =1mA V _{GS} =0V	60			V
Gate Threshold Voltage	V _{GS(th)}	I _D =1mA V _{DS} =V _{GS}	1,0	1,5	2,5	V
Zero Gate Voltage Drain Current	I _{DSS}	V _{DS} =60V T _{ch} =25°C		10	500	μA
		V _{GS} =0V T _{ch} =125°C		0,2	1,0	mA
Gate Source Leakage Current	I _{GSS}	V _{GS} =±20V V _{DS} =0V		10	100	nA
Drain Source On-State Resistance	R _{DS(on)}	I _D =25A V _{GS} =4V		0,022	0,04	Ω
		I _D =25A V _{GS} =10V		0,015	0,025	Ω
Forward Transconductance	g _{fs}	I _D =25A V _{DS} =25V	20	36		S
Input Capacitance	C _{iss}	V _{DS} =25V		2600	3900	pF
Output Capacitance	C _{oss}	V _{GS} =0V		800	1200	pF
Reverse Transfer Capacitance	C _{rss}	f=1MHz		400	600	pF
Turn-On-Time t _{on} (t _{on} =t _{d(on)} +t _r)	t _{d(on)}	V _{CC} =30V		20	30	ns
	t _r	I _D =50A		130	200	ns
Turn-Off-Time t _{off} (t _{off} =t _{d(off)} +t _f)	t _{d(off)}	V _{GS} =10V		400	600	ns
	t _f	R _{GS} =25 Ω		170	250	ns
Continous Reverse Drain Current	I _{DR}				50	A
Pulsed Reverse Drain Current	I _{DRM}				200	A
Diode Forward On-Voltage	V _{SD}	I _F =2I _{DR} V _{GS} =0V T _{ch} =25°C		1,35	2,0	V
Reverse Recovery Time	t _{rr}	I _F =I _{DR} V _{GS} =0V		100		ns
Reverse Recovery Charge	Q _{rr}	-di _F /dt=100A/μs T _{ch} =25°C		0,5		μC

- Thermal Characteristics

Item	Symbol	Test conditions	Min.	Typ.	Max.	Unit
Thermal Resistance	R _{th(ch-a)}	channel to air			75	°C/W
	R _{th(ch-c)}	channel to case			1,56	°C/W

> Characteristics

Typical Output Characteristics

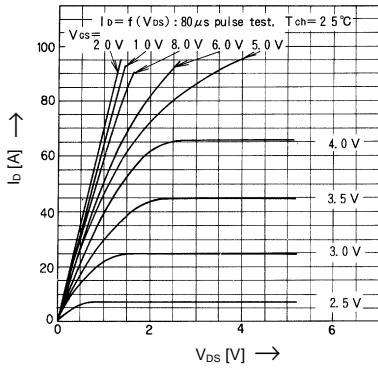

Drain-Source-On-State Resistance vs. Tch

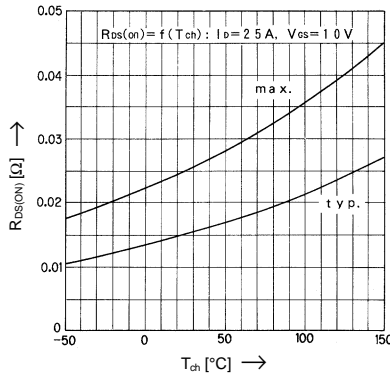

Typical Transfer Characteristics

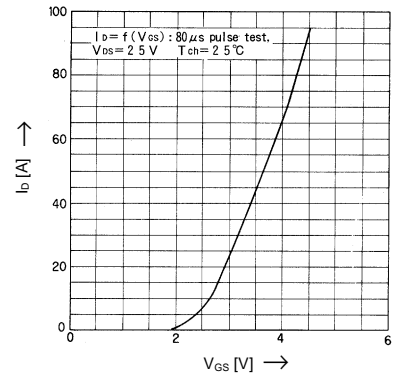

Typical Drain-Source-On-State-Resistance vs. Id

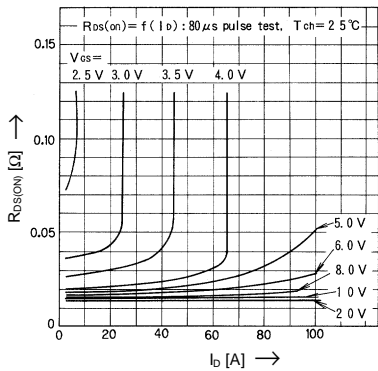

Typical Forward Transconductance vs. Id

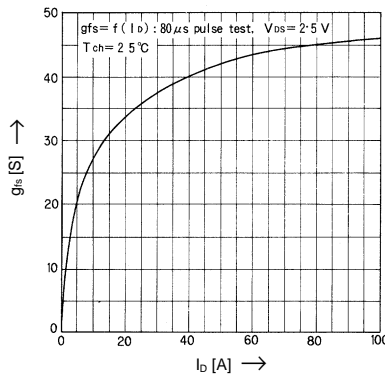

Gate Threshold Voltage vs. Tch

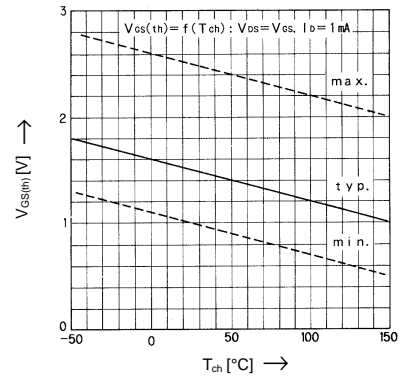

Typical Capacitance vs. Vds

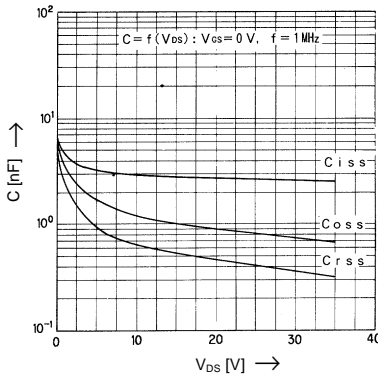

Typical Input Charge

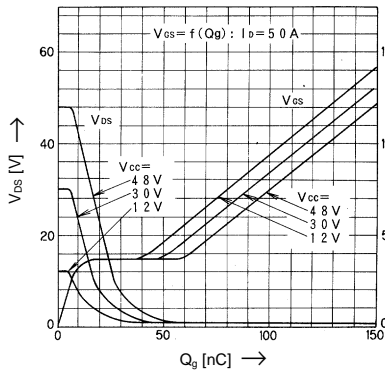

Forward Characteristics of Reverse Diode

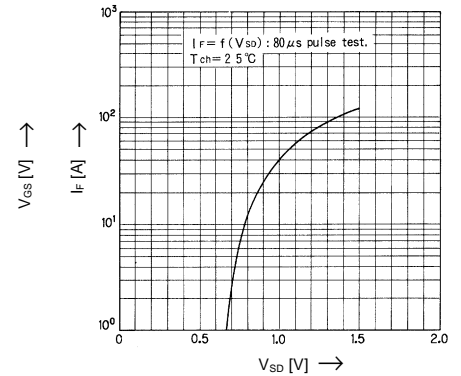

Allowable Power Dissipation vs. Tch

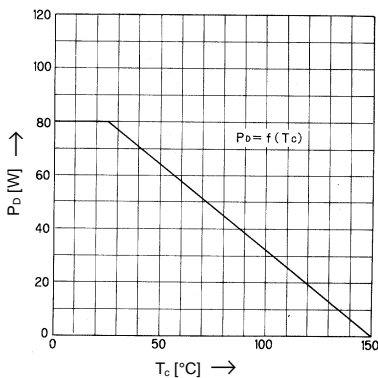

Safe operation area

