

## Excellent Integrated System Limited

Stocking Distributor

Click to view price, real time Inventory, Delivery & Lifecycle Information:

[Sharp Microelectronics](#)  
[LQ121S1LG88](#)

For any questions, you can email us directly:

[sales@integrated-circuit.com](mailto:sales@integrated-circuit.com)

PREPARED BY: DATE	 LIQUID CRYSTAL DISPLAY GROUP SHARP CORPORATION <b>SPECIFICATION</b>	SPEC No. LD-24604A
APPROVED BY: DATE		FILE No. LD-24604A
		ISSUE : 26-Jun-12
		PAGE : 22pages
		APPLICABLE GROUP DISPLAY DEVICE BUSINESS GROUP

REVISION : 26-Jun-12

DEVICE SPECIFICATION FOR  
**TFT-LCD Module**  
 MODEL No.  
**LQ121S1LG88**

These parts have corresponded with the RoHS directive.

CUSTOMER'S APPROVAL

BY \_\_\_\_\_

BY   
 J.Kawanishi  
 GENERAL MANAGER  
 DEPARTMENT DEPT. I  
 LIQUID CRYSTAL DISPLAY DIVISION II  
 DISPLAY DEVICE BUSINESS GROUP  
 SHARP CORPORATION



- Contents -

No.		page
1	Application .....	1
2	Overview .....	2
3	Mechanical Specifications .....	2
4	Input Terminals .....	3
5	Absolute Maximum Ratings .....	9
6	Electrical Characteristics .....	10
7	Timing characteristics of input signals .....	12
8	Input Signals, Basic Display Colors and Gray Scale of Each Color ..	13
9	Optical Characteristics .....	15
10	Handling Precautions .....	17
11	Packing form .....	18
12	Reliability test items .....	18
13	Others .....	19
14	Storage conditions .....	20
Fig.1	OUTLINE DIMENSIONS .....	21
Fig.3	PACKING FORM .....	22

## 1. Application

This specification applies to the color TFT-LCD module LQ121S1LG88.

This specification is the proprietary product of SHARP CORPORATION (SHARP) and include materials protected under copyright of SHARP. Do not reproduce or cause any third party to reproduce them in any form or by any means, electronic or mechanical, for any purpose, in whole or in part, without the express written permission of SHARP.

The device listed in this specification was designed and manufactured for use in general electronic equipment.

In case of using the device for applications such as control and safety equipment for transportation (controls of aircraft, trains, automobiles, etc.), rescue and security equipment and various safety related equipment which require higher reliability and safety, take into consideration that appropriate measures such as fail-safe functions and redundant system design should be taken.

Do not use the device for equipment that requires an extreme level of reliability, such as aerospace applications, telecommunication equipment (trunk lines), nuclear power control equipment and medical or other equipment for life support.

SHARP assumes no responsibility for any damage resulting from the use of the device which does not comply with the instructions and the precautions specified in this specification .

Contact and consult with a SHARP sales representative for any questions about this device.

## 2. Overview

This module is a color active matrix LCD module incorporating amorphous silicon TFT (Thin Film Transistor). It is composed of a color TFT-LCD panel, driver ICs, control circuit, power supply circuit and a White-LED Backlight unit. Graphics and texts can be displayed on a 800 × RGB × 600dots panel with about 262144 colors by using LVDS (Low Voltage Differential Signaling) and supplying +3.3V DC supply voltages for TFT-LCD panel driving and supply voltage for backlight.

The maximum viewing angle is in the 6o'clock direction.

The 12o'clock direction is difficult to reverse the grayscale.

By the independent RGB gamma adjustment function, this module can display natural gray scales.

The LED driver circuit and the PWM circuit to drive the backlight are built into the module.

## 3. Mechanical technical literatures

Parameter	technical literatures	Unit
Display size	31 (12.1inch) Diagonal	cm
Active area	246 (H) × 184.5 (V)	mm
Pixel format	800 (H) × 600 (V) (1pixel=R+G+B dot)	pixel
Aspect ratio	4:3	
Pixel pitch	0.3075 (H) × 0.3075 (V)	mm
Pixel configuration	R,G,B vertical stripe	
Display mode	Normally white	
Unit outline dimensions 【*1】	276.0 (W) × 209.0 (H) × 9.1 (D)	mm
Mass	750 (Max.)	g
Surface treatment	Anti-glare and hard-coating 3H	

【\*1】 Excluding the protrusion of the connector cover from thickness.

Outline dimensions are shown in Fig.1.

## 4. Input Terminals

### 4-1. TFT-LCD panel driving

CN1 (Interface signals and +3.3V power supply)

Using connectors: FI-SEB20P (Japan Aviation Electronics industry Co., Ltd.)

Corresponding connectors: FI-SE20M or FI-S20S (Japan Aviation Electronics industry Co., Ltd.)

Using LVDS receiver: Building into cotroll IC (THC63LVDF84B(Thine electronics) or Compatible product)

Corresponding LVDS transmitter: THC63LVDM83R(Thine electronics) or Compatible product

CN1

Pin	Symbol	Function	Remark
1	VCC	+3.3V Power supply	
2	VCC	+3.3V Power supply	
3	GND	GND	
4	GND	GND	
5	RxIN0-	LVDS receiver signal CH0 (-)	LVDS
6	RxIN0+	LVDS receiver signal CH0 (+)	LVDS
7	GND	GND	
8	RxIN1-	LVDS receiver signal CH1 (-)	LVDS
9	RxIN1+	LVDS receiver signal CH1 (+)	LVDS
10	GND	GND	
11	RxIN2-	LVDS receiver signal CH2 (-)	LVDS
12	RxIN2+	LVDS receiver signal CH2 (+)	LVDS
13	GND	GND	
14	CK IN-	LVDS receiver signal CK (-)	LVDS
15	CK IN+	LVDS receiver signal CK (+)	LVDS
16	GND	GND	
17	NC	Non Connection	
18	RL/UD	Horizontal/Vertical display mode select signal	【*1】
19	GND	GND	
20	GND	GND	

【\*1】 RL/UD = LOW

RL/UD = HIGH



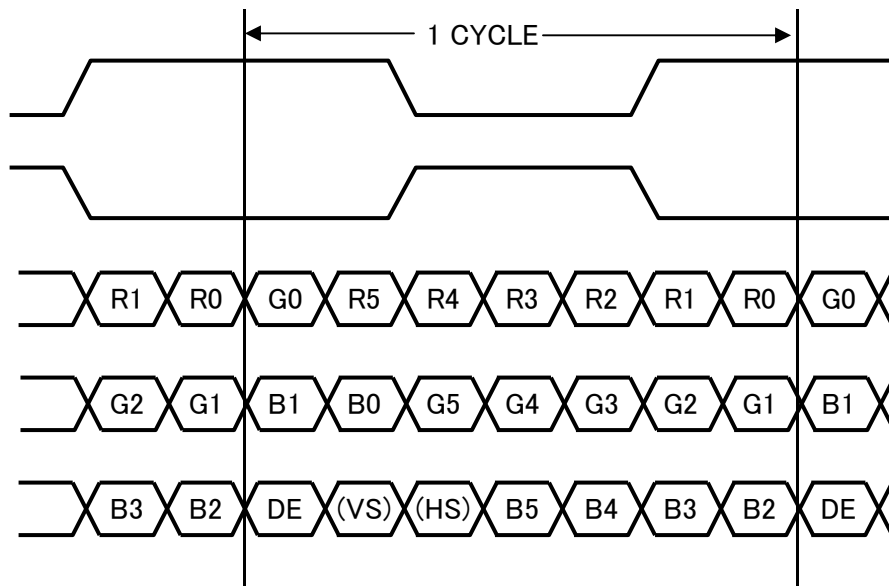

DE: DATA ENABLE

HS: Hsync

VS: Vsync

NA: Non Available

**4-2. Interface block diagram**

(Computer Side)

(TFT-LCD side)

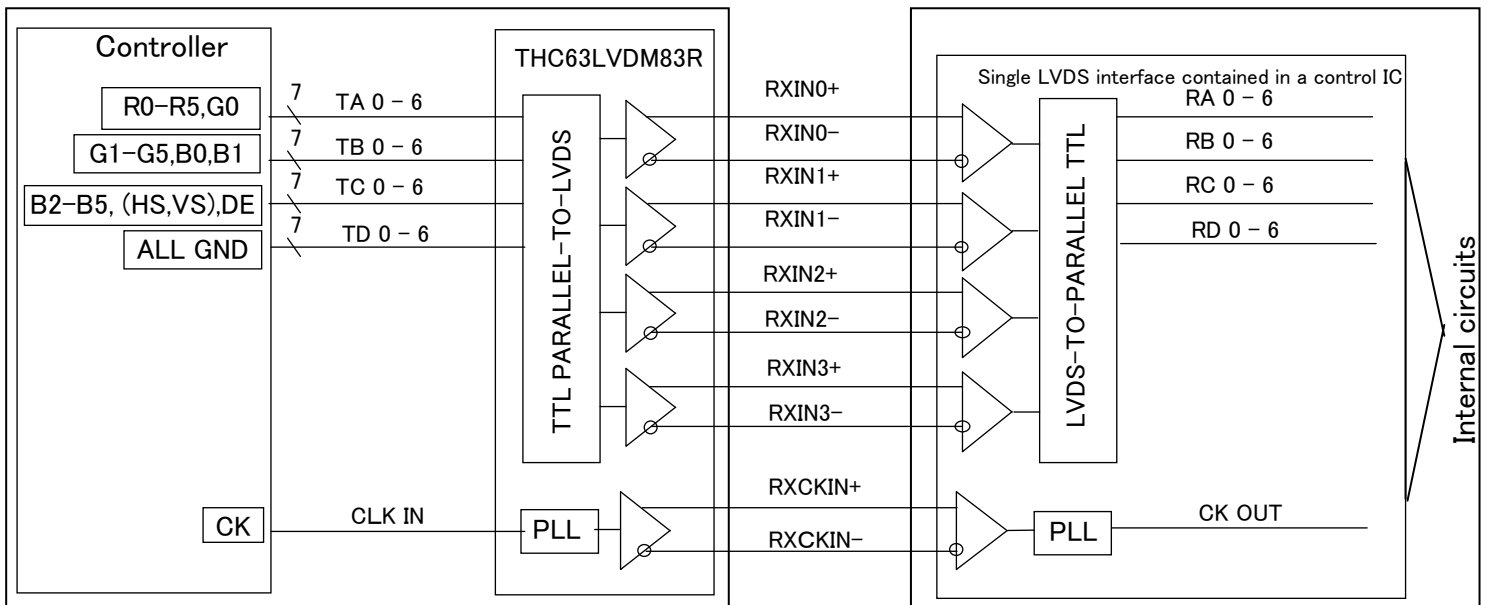



### 4-3. LED backlight

LED backlight connector

CN2      Used connector    :    SM06B-SHLS-TF      ( J.S.T. Mfg. Co. Ltd ) or equivalent

Corresponding connector    :    SHLP-06V-S-B                      ( J.S.T. Mfg. Co. Ltd )

Connector No.	Pin No.	symbol	function
CN2	1	VDD	+12V power supply
	2	VDD	+12V power supply
	3	GND	GND
	4	GND	GND
	5	XSTABY	Backlight ON/OFF signal
	6	VBR	PWM signal

## 5. Absolute Maximum Ratings

Parameter	Symbol	Condition	Pin	Ratings	Unit	Remark
Supply voltage	V <sub>CC</sub>	T <sub>a</sub> =25°C	VCC	-0.3 ~ +4.0	V	【*1,2】
	V <sub>DD</sub>	T <sub>a</sub> =25°C	VDD	-0.3 ~ +15.0	V	【*1,2】
Input voltage	V <sub>I1</sub>	T <sub>a</sub> =25°C	RxINi-/+ CK IN-/+	-0.3~V <sub>CC</sub> +0.3	V	i=0,1,2,3
	V <sub>I2</sub>	T <sub>a</sub> =25°C	RL/UD,SELLVDS	-0.3~V <sub>CC</sub> +0.3	V	
	V <sub>I4</sub>	T <sub>a</sub> =25°C	XSTABY, VBR	-0.3~V <sub>DD</sub>	V	
Storage temperature	T <sub>STG</sub>	—	—	-30 ~ +80	°C	【*1】
Operating temperature	T <sub>OPA</sub>	—	—	-15 ~ +70	°C	【*1,3,4】

【\*1】 Humidity: 95%RH Max.( T<sub>a</sub> ≤ 40°C ) Note static electricity.

Maximum wet-bulb temperature at 39°C or less. (T<sub>a</sub> > 40°C) No condensation.

【\*2】 The V<sub>CC</sub> power supply capacity must use the one of 2A or more.

The V<sub>DD</sub> power supply capacity must use the one of 3A or more.

【\*3】 There is a possibility of causing deterioration in the irregularity and others of the screen and the display fineness though the liquid crystal module doesn't arrive at destruction when using it at 65~70°C.

There is a possibility of causing the fineness deterioration by the prolonged use in the (high temperature) humidity environment (60% or more).

【\*4】 In the operating temperature item, the low temperature side is the ambient temperature regulations.

The high temperature side is the panel surface temperature regulations.

## 6. Electrical Characteristics

### 6-1. TFT-LCD panel driving

T<sub>a</sub> = +25°C

Parameter	Symbol	Condition	Min.	Typ.	Max.	Unit	Remark
Supply voltage	V <sub>CC</sub>		3.0	3.3	3.6	V	【*1】
Current dissipation	I <sub>CC</sub>	V <sub>CC</sub> =3.3V	-	300	400	mA	【*2】
Input voltage width for LVDS receiver	V <sub>L</sub>		0	-	2.4	V	
Permissive input ripple voltage	V <sub>RP</sub>		-	-	200	mV <sub>P-P</sub>	V <sub>CC</sub> = 3.3V
Differential input Threshold voltage	High	V <sub>TH</sub>	-	-	V <sub>CM</sub> +100	mV	V <sub>CM</sub> = +1.2V 【*3】
	Low	V <sub>TL</sub>	V <sub>CM</sub> -100	-	-	mV	
Input voltage	V <sub>IH</sub>		2.1	-	-	V	【*4】
	V <sub>IL</sub>		-	-	0.8	V	
Input leak current	I <sub>OH</sub>		-	-	400	μA	V <sub>I2</sub> = +3.3V【*4】
	I <sub>OL</sub>		-10	-	+10	μA	V <sub>I2</sub> = 0V【*4】
Terminal resistor	R <sub>T</sub>		-	100	-	Ω	Differential input

#### 【\*1】 On-off conditions for supply voltage

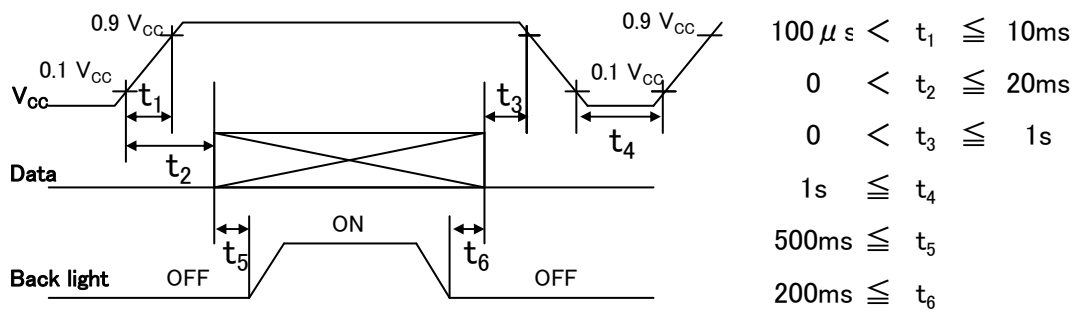

#### V<sub>CC</sub>-dip conditions

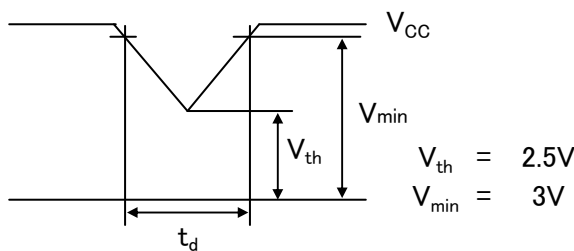

- $V_{th} < V_{CC} \leq V_{min}$   
 $t_d \leq 10ms$

- $V_{CC} < V_{th}$

V<sub>CC</sub>-dip conditions should also follow the On-off conditions for supply voltage

- Hsync/Vsync need not be input so that this model may drive only by the ENAB signal. Even if Hsync/Vsync is input, it doesn't become a malfunction.
- The relation between the data input and the backlight lighting will recommend the above-mentioned input sequence. When the backlight is turned on before the panel operates, there is a possibility of abnormally displaying. The liquid crystal module is not damaged.

#### 【\*2】 Current dissipation

Typical current situation : 64-gray-bar pattern

( V<sub>CC</sub>=+3.3V、f<sub>ck</sub> = 40MHz、T<sub>a</sub>=25°C )

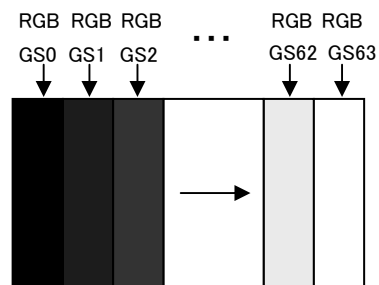

#### 【\*3】 V<sub>CM</sub> : LVDS common mode voltage

#### 【\*4】 RL/UD , SELLVDS

## 6-2. LED backlight

Ta=+25°C

Parameter	Symbol	Min.	Typ.	Max.	Unit	Remark	
Supply voltage	V <sub>DD</sub>	10.2	12.0	13.8	V	【*1】	
Current dissipation	I <sub>DD1</sub>	-	600	750	mA	【*2】	
	I <sub>DD2</sub>	-	-	12	mA		
Permissive input ripple voltage	V <sub>RP_BL</sub>	-	-	200.0	mV <sub>P-P</sub>	V <sub>DD</sub> =+12.0V	
XSTABY	High voltage	V <sub>IH_BL1</sub>	2.4	-	V <sub>DD</sub>	V	【*3】
	Low voltage	V <sub>IL_BL1</sub>	-	-	0.2	V	【*3】
VBR	High voltage	V <sub>IH_BL2</sub>	2.1	-	V <sub>DD</sub>	V	【*4】
	Low voltage	V <sub>IL_BL2</sub>	-	-	0.8	V	【*4】
PWM frequency	f <sub>PWM</sub>	200.0	-	1k	Hz	【*4,5】	
PWM duty	D <sub>PWM</sub>	10.0	-	100.0	%	【*4,5】	
Life time	L	-	(50,000) (Module)	-	h	【Reference】 【*6】	

### 【\*1】 On-off conditions for supply voltage

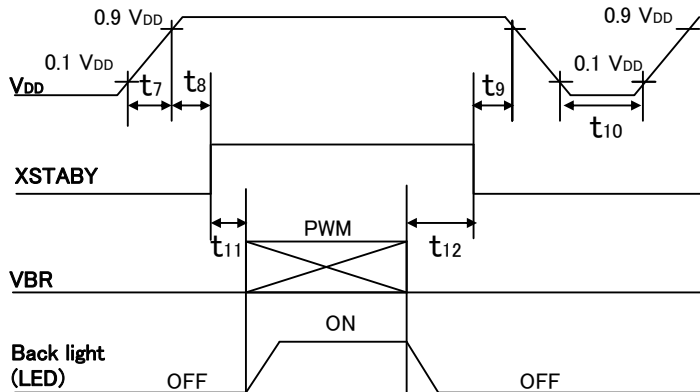

$$100 \mu s \leq t_7 \leq 200ms$$

$$0ms \leq t_8$$

$$0ms \leq t_9$$

$$200ms \leq t_{10}$$

$$10ms \leq t_{11}$$

$$0ms \leq t_{12}$$

### 【\*2】 Current dissipation

Typ. value: V<sub>DD</sub>= +12V、Duty=100%

Max. value: V<sub>DD</sub>= +10.2V、Duty=100%

### 【\*3】 Backlight ON/OFF signal (connected by the pull-down resistor of 10k Ω)

### 【\*4】 PWM signal (connected by the pull-down resistor of 10k Ω)

### 【\*5】 PWM

$$f_{PWM} = 1/t_{14}$$

Duty 10% : Min. Luminance (0%: LED OFF)

Duty 100% : Max. Luminance

Luminance changes in proportion to the duty ratio. (t<sub>13</sub> ≥ 500 μs)

When the frequency slows, the display fineness might decrease.

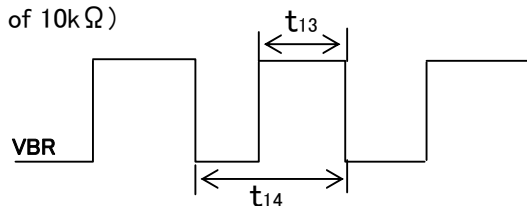

### 【\*6】 Luminance becomes 50% of an initial value. (Ta=25°C, PWM=100%)

## 7. Timing characteristics of input signals

### 7-1. Timing characteristics

Parameter	Symbol	Min.	Typ.	Max.	Unit	Remark	
Clock	Frequency	1/Tc	35.0	40	42.0	MHz	
ENAB	Horizontal period	TH	940	1056	1395	clock	
			23.5	26.4	39.9	$\mu$ s	
	Horizontal period (High)	THd	800	800	800	clock	
	Vertical Frequency	TV	628	666	798	line	【*1】
			-	16.7	-	ms	
Vertical period (High)	TVd	600	600	600	line		

【\*1】 In case of using the long vertical period, the deterioration of display quality, flicker etc. may occur.

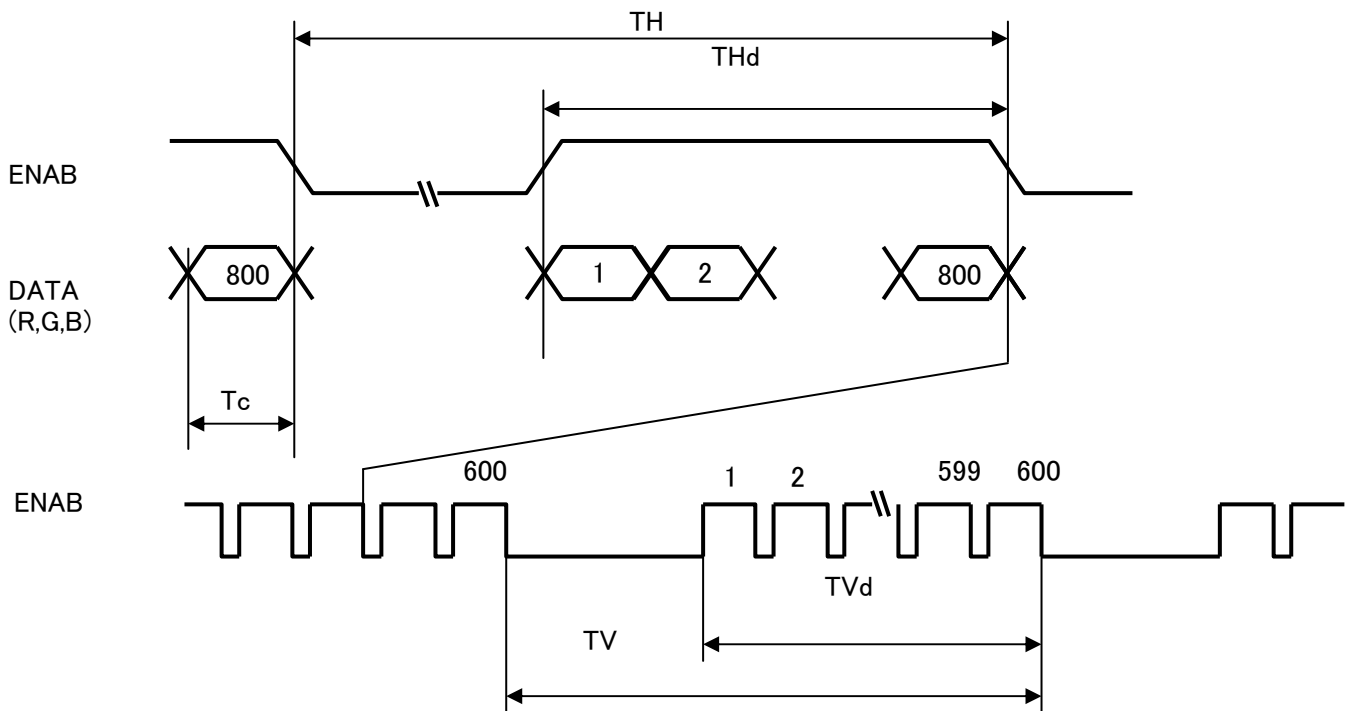

### 7-2. Input Data Signals and Display Position on the screen

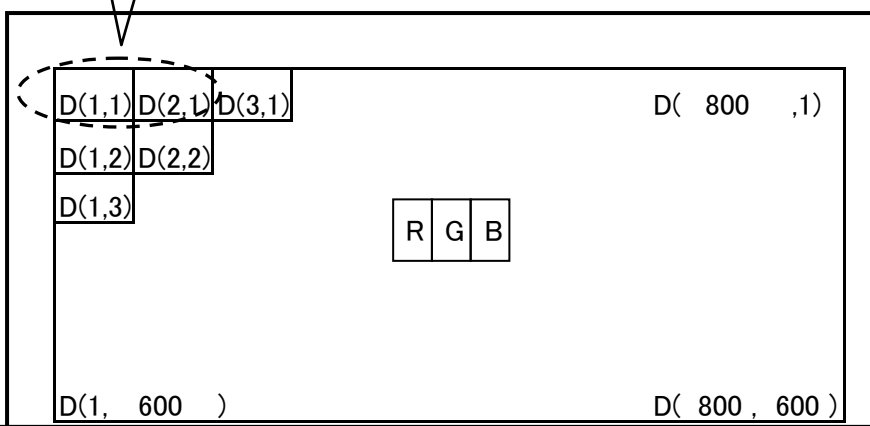
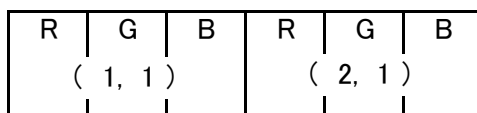

## 8. Input Signals, Basic Display Colors and Gray Scale of Each Color

	Colors & Gray scale	Data signal																		
		GrayScale	R0	R1	R2	R3	R4	R5	G0	G1	G2	G3	G4	G5	B0	B1	B2	B3	B4	B5
Basic Color	Black	—	0	0	0	0	0	0	0	0	0	0	0	0	0	0	0	0	0	0
	Blue	—	0	0	0	0	0	0	0	0	0	0	0	0	1	1	1	1	1	1
	Green	—	0	0	0	0	0	0	1	1	1	1	1	1	0	0	0	0	0	0
	Cyan	—	0	0	0	0	0	0	1	1	1	1	1	1	1	1	1	1	1	1
	Red	—	1	1	1	1	1	1	0	0	0	0	0	0	0	0	0	0	0	0
	Magenta	—	1	1	1	1	1	1	0	0	0	0	0	0	1	1	1	1	1	1
	Yellow	—	1	1	1	1	1	1	1	1	1	1	1	1	0	0	0	0	0	0
	White	—	1	1	1	1	1	1	1	1	1	1	1	1	1	1	1	1	1	1
Gray Scale of Red	Black	GS0	0	0	0	0	0	0	0	0	0	0	0	0	0	0	0	0	0	0
	↑	GS1	1	0	0	0	0	0	0	0	0	0	0	0	0	0	0	0	0	0
	Darker	GS2	0	1	0	0	0	0	0	0	0	0	0	0	0	0	0	0	0	0
	↑	↓	↓					↓					↓							
	↓	↓	↓					↓					↓							
	Brighter	GS61	1	0	1	1	1	1	0	0	0	0	0	0	0	0	0	0	0	0
	↓	GS62	0	1	1	1	1	1	0	0	0	0	0	0	0	0	0	0	0	0
Red	GS63	1	1	1	1	1	1	0	0	0	0	0	0	0	0	0	0	0	0	
Gray Scale of Green	Black	GS0	0	0	0	0	0	0	0	0	0	0	0	0	0	0	0	0	0	0
	↑	GS1	0	0	0	0	0	0	1	0	0	0	0	0	0	0	0	0	0	0
	Darker	GS2	0	0	0	0	0	0	0	1	0	0	0	0	0	0	0	0	0	0
	↑	↓	↓					↓					↓							
	↓	↓	↓					↓					↓							
	Brighter	GS61	0	0	0	0	0	0	1	0	1	1	1	1	0	0	0	0	0	0
	↓	GS62	0	0	0	0	0	0	0	1	1	1	1	1	0	0	0	0	0	0
Green	GS63	0	0	0	0	0	0	1	1	1	1	1	1	0	0	0	0	0	0	
Gray Scale of Blue	Black	GS0	0	0	0	0	0	0	0	0	0	0	0	0	0	0	0	0	0	0
	↑	GS1	0	0	0	0	0	0	0	0	0	0	0	0	1	0	0	0	0	0
	Darker	GS2	0	0	0	0	0	0	0	0	0	0	0	0	0	1	0	0	0	0
	↑	↓	↓					↓					↓							
	↓	↓	↓					↓					↓							
	Brighter	GS61	0	0	0	0	0	0	0	0	0	0	0	0	1	0	1	1	1	1
	↓	GS62	0	0	0	0	0	0	0	0	0	0	0	0	0	1	1	1	1	1
Blue	GS63	0	0	0	0	0	0	0	0	0	0	0	0	1	1	1	1	1	1	

Each basic color can be displayed in 64 gray scales from 6 bit data signals. According to the combination of total 18 bit data signals, the 262,144-color display can be achieved on the screen.

## 9. Optical Characteristics

Ta=+25°C, Vcc=+3.3V

Parameter		Symbol	Condition	Min.	Typ.	Max.	Unit	Remark	
Viewing angle range	Horizontal	$\theta 21, \theta 22$	CR>10	70	80	-	Deg.	【*1,2,4】	
	Vertical	$\theta 11$		50	60	-	Deg.		
		$\theta 12$		70	80	-	Deg.		
Contrast ratio		CR	optimized angle	500	800	-		【*2,4】	
Response Time	White Black	$\tau r + \tau d$	$\theta = 0^\circ$	-	30	-	ms	【*3,4】	
Chromaticity of White	Wx			0.250	0.300	0.350		【*4】	
	Wy			0.265	0.315	0.365			
Chromaticity of Red	Rx			-	0.570	-			
	Ry			-	0.330	-			
Chromaticity of Green	Gx			-	0.330	-			
	Gy			-	0.600	-			
Chromaticity of Blue	Bx			-	0.150	-			
	By			-	0.100	-			
Luminance of white		$Y_{L1}$			350	450	-		cd/m <sup>2</sup>
White Uniformity		$\delta w$		75	-	-	%		【*5】

※The measurement shall be executed 30 minutes after lighting at rating.

The optical characteristics shall be measured in a dark room or equivalent state with the method shown in Fig.2 below.

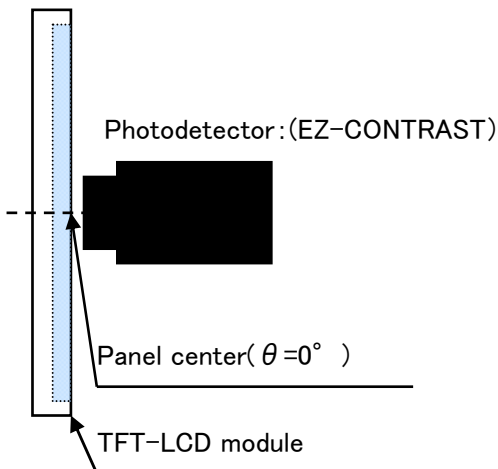

fig.2-1 Measuring method of Viewing angle range.

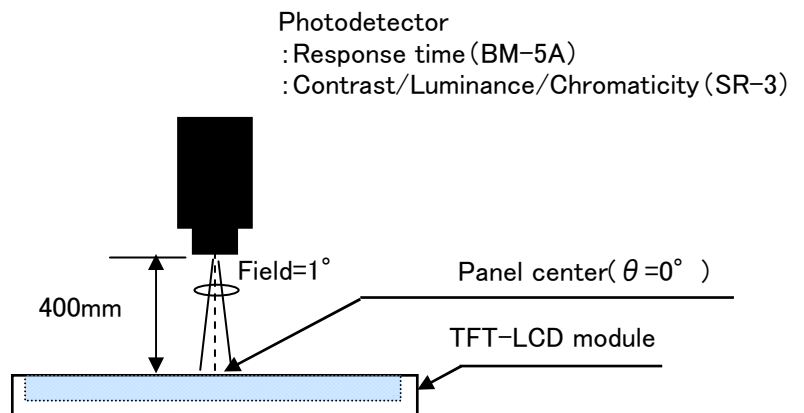
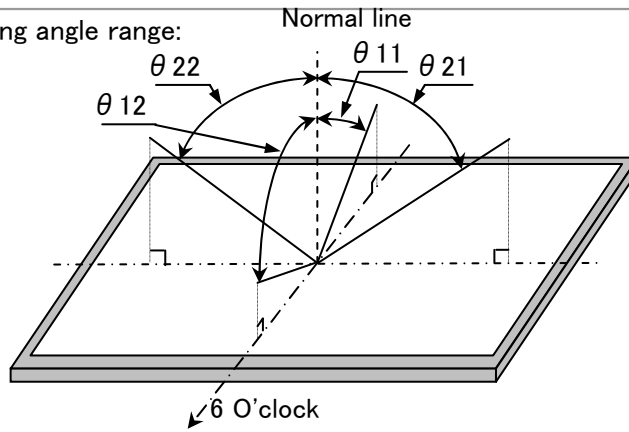

fig.2-2 Measuring method of contrast, luminance, response time, and Chromaticity.

Fig.2 Optical characteristics measurement method

【\*1】Definitions of viewing angle range:



【\*2】Definition of contrast ratio:

The contrast ratio is defined as the following. 
$$\text{Contrast (CR)} = \frac{\text{Luminance with all pixels white}}{\text{Luminance with all pixels black}}$$

【\*3】Definition of response time:

The response time is defined as the following figure and shall be measured by switching the input signal for "black" and "white".

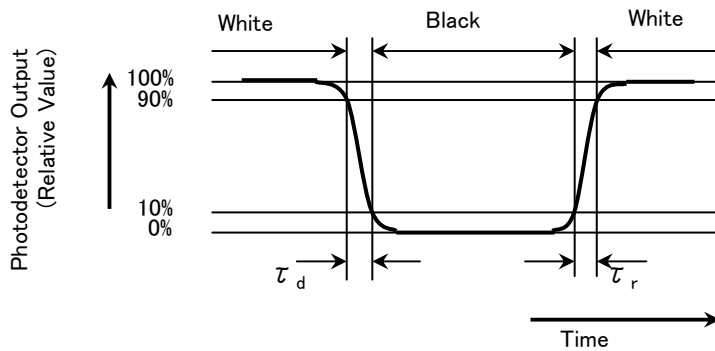

【\*4】This shall be measured at center of the screen.

【\*5】Definition of white uniformity:

White uniformity is defined as the following with five measurements.

(①~⑤)

$$\delta_w = \frac{\text{Maximum luminance of 5 points(①~⑤)}}{\text{Minimum luminance of 5 points(①~⑤)}} \times 100\%$$

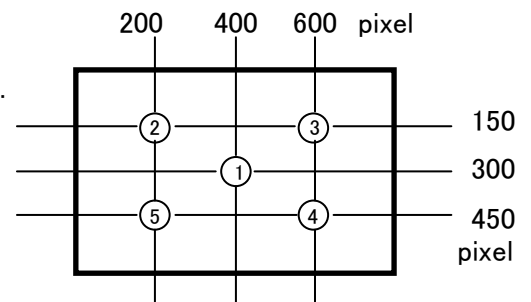



## 10. Handling Precautions

- a) Be sure to turn off the power supply when inserting or disconnecting the cable.
- b) Since the front polarizer is easily damaged, pay attention not to scratch it.
- c) Wipe off water drop immediately. Long contact with water may cause discoloration or spots.
- d) When the panel surface is soiled, wipe it with absorbent cotton or other soft cloth.
- e) Since the panel is made of glass, it may break or crack if dropped or bumped on hard surface.  
Handle with care.
- f) Since CMOS LSI is used in this module, take care of static electricity and injure the human earth when handling. Observe all other precautionary requirements in handling components.
- g) Since there is a circuit board in the module back, stress is not added at the time of a design assembly. Please make it like. If stress is added, there is a possibility that circuit parts may be damaged.
- h) It causes an irregular display and the defective indication, etc., when always put constant pressure on the back of the module.  
Please do not make the structure to press the back of the module.
- i) Do not expose the LCD panel to direct sunlight. Lightproof shade etc. should be attached when LCD panel is used under such environment.
- j) Connect GND to stabilize against EMI and external noise.
- k) When handling LCD modules and assembling them into cabinets, please avoid that long-terms storage in the environment of oxidization or deoxidization gas and the use of such materials as reagent, solvent, adhesive, resin, etc. which generate these gasses, may cause corrosion and discoloration of the modules. Do not use the LCD module under such environment.
- l) Liquid crystal contained in the panel may leak if the LCD is broken. Rinse it as soon as possible if it gets inside your eye or mouth by mistake.
- m) Be careful when using it for long time with fixed pattern display as it may cause accidental image.
- n) Adjusting volume have been set optimally before shipment, so do not change any adjusted value. If adjusted value is changed, the specification may not be satisfied.
- o) If a minute particle enters in the module and adheres to an optical material, it may cause display non-uniformity issue, etc. Therefore, fine-pitch filters have to be installed to cooling and inhalation hole if you intend to install a fan.
- p) The polarizer surface on the panel is treated with Anti-Glare for low reflection. In case of attaching protective board over the LCD, be careful about the optical interface fringe etc. which degrades display quality.
- q) Notice : Never take to pieces the module , because it will cause failure.  
Please do not peel off the Black tape pasted to the product.
- r) An abnormal display by changing in quality of the polarizing plate might occur regardless of contact or no contact to the polarizing plate, because of epoxy resin (amine system curing agent) that comes out from the material and the packaging material used for the set side, the silicon adhesive (dealcoholization system and oxime system), and the tray blowing agents (azo-compound), etc.  
Please confirm adaptability with your employed material.

## 11. Packing form

- a) Piling number of cartons : MAX. 4
- b) Package quantity in one carton: 30pcs
- c) Carton size(TYP): 520mm(W) × 370mm(D) × 315mm(H)
- d) Total mass of one carton filled with full modules(30pcs): MAX 26kg

## 12. Reliability test items

No.	Test item	Conditions	Remark
1	High temperature storage test	Ambient temperature 80°C 240H	【Note1】
2	Low temperature strage test	Ambient temperature -30°C 240H	【Note1】
3	High temperature & high humidity operation test	Ambient temperature 40°C、Humidity 95% RH 240H (No condensation.)	【Note1】
4	High temperature operation test	Panel surface 70°C 240H	【Note1】
5	Low temperature operation test	Ambient temperature -15°C 240H	【Note1】
6	Vibration test (non-operating)	<Sin wave> Frequency : 10~57Hz/Vibration width (one side) : 0.076mm : 57~500Hz/Gravity: 9.8m/s <sup>2</sup> Sweep time: 11minutes Test period : 3H(X, Y, Z direction 1H)	【Note1】
7	Shock test (non-operating)	Max. gravity: 490m/s <sup>2</sup> Pulse width: 11ms Direction: ±X, ±Y, ±Z Test period : 1time/1direction	【Note1】
8	Thermal shock test	-30°C[0.5h]~80°C[0.5h]/50cycles	【Note1】

【Note1】 Under the display quality test conditions with normal operation state, these shall be no change which may affect practical display function. (normal operation state: Temperature:15~35°C, Humidity:45~75%, Atmospheric pressure:86~106kpa)

### 13. Others

#### 13-1. Lot No Label:

##### A) Module serial label

The label that displays SHARP·Model No.( LQ121S1LG88)·Lot No. is stuck on the back of the module.

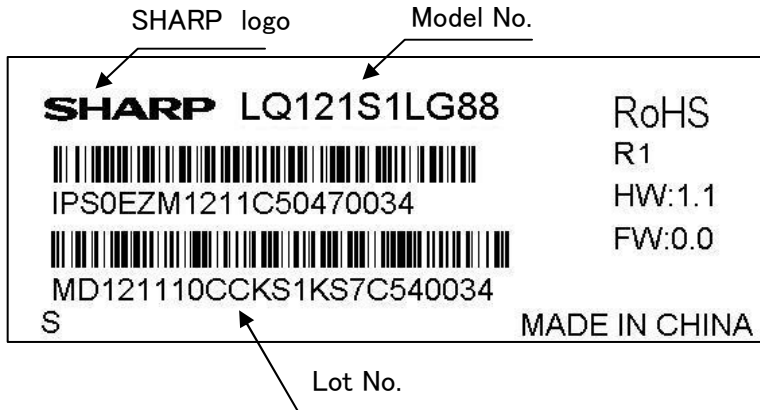

#### 13-2. Packing box Label:

The label that displays ①Model number( LQ121S1LG88) ②Lot number ③Quantity of module is stuck on the packing box. Moreover, the display of bar code also applies to this.

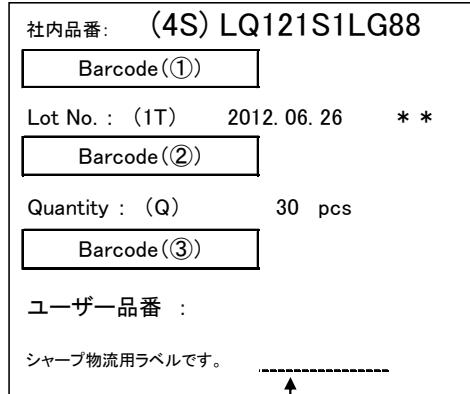

- ① Model number( LQ121S1LG88)
- ② Lot number (DATA)
- ③ Quantity of module

Our management product number might be filled  
(Example: LQ121S1LG88A etc.)

A right picture is written to the packing box of module for the RoHS restriction.

※ R.C.(RoHs Compliance)means these parts have corresponded with the RoHs directive.

This module corresponds from the first sample to RoHS Directive.



The figure below is written under the SHARP logo of the packing box about the production country.

MADE IN CHINA

#### 13-3. The ozone-depleting substances is not used.

#### 13-4. If any problem occurs in relation to the description of this specification , it shall be resolved through discussion with spirit of cooperation.

## 14. Storage conditions

Environmental condition range of storage temperature and humidity

Temperature 0 to 40 degrees Celsius

Relative humidity 95% and below

【Note】Please refer below as a mean value of the environmental conditions.

Summer time temperature 20 to 35 degrees Celsius humidity , 85% and below

Winter time temperature 5 to 15 degrees Celsius humidity , 85% and below

Please maintain within 240 hours of accumulated length of storage time, with conditions of 40 degrees Celsius and room humidity of 95%.

Direct sun light

Please keep the product in a dark room or cover the product to protect from direct sun light.

Atmospheric condition

Please refrain from keeping the product with possible corrosive gas or volatile flux.

Prevention of dew

Please store the product carton either on a wooden pallet or a stand / rack to prevent dew.

Do not place directly on the floor. In addition, to obtain moderate ventilation in between the pallet's top and bottom surfaces, pile the cartons up in a single direction and in order.

Please place the product cartons away from the storage wall.

Storage period

Within above mentioned conditions, maximum storage period should be one year.

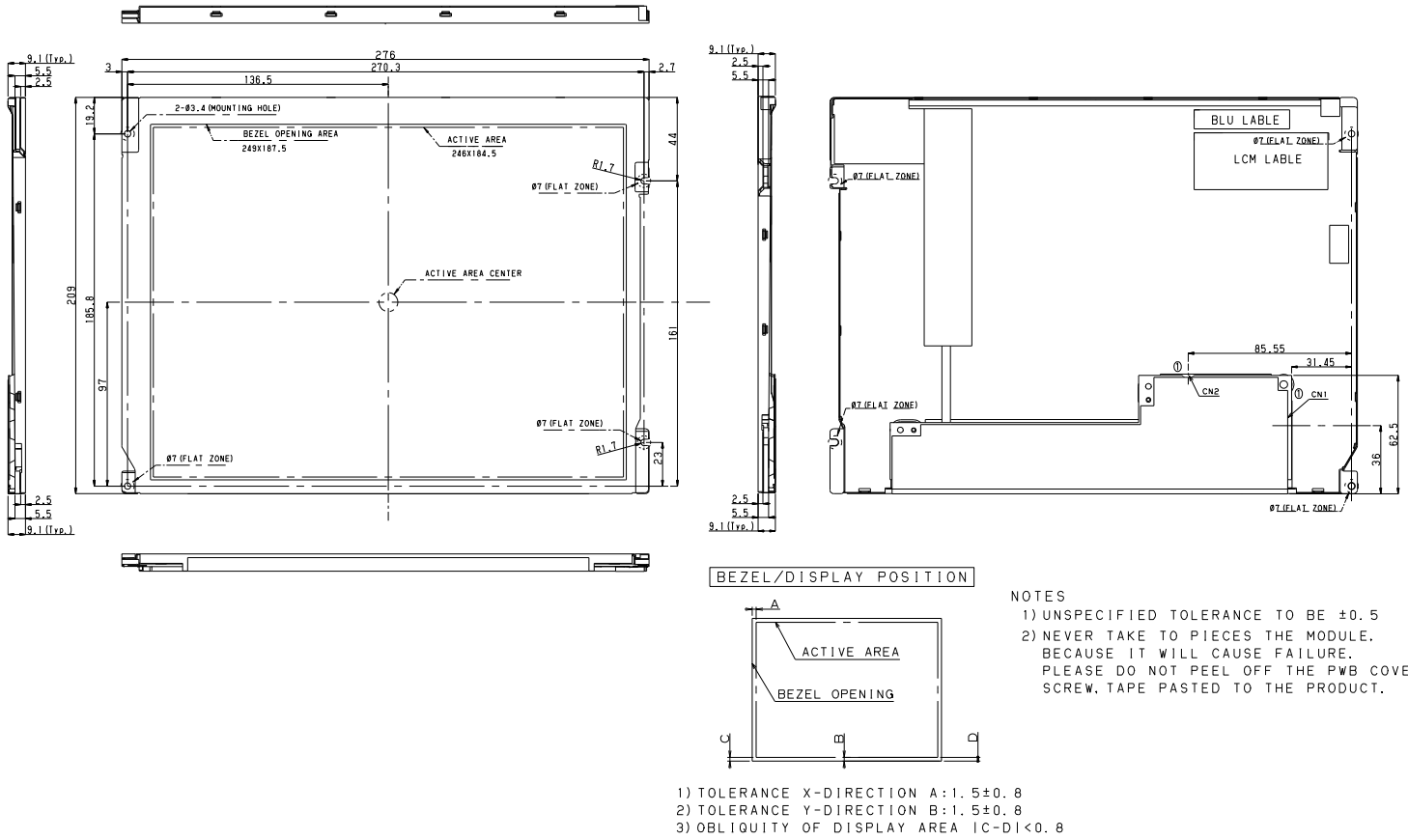

Fig.1 : LQ121S1LG88 OUTLINE DIMENSIONS

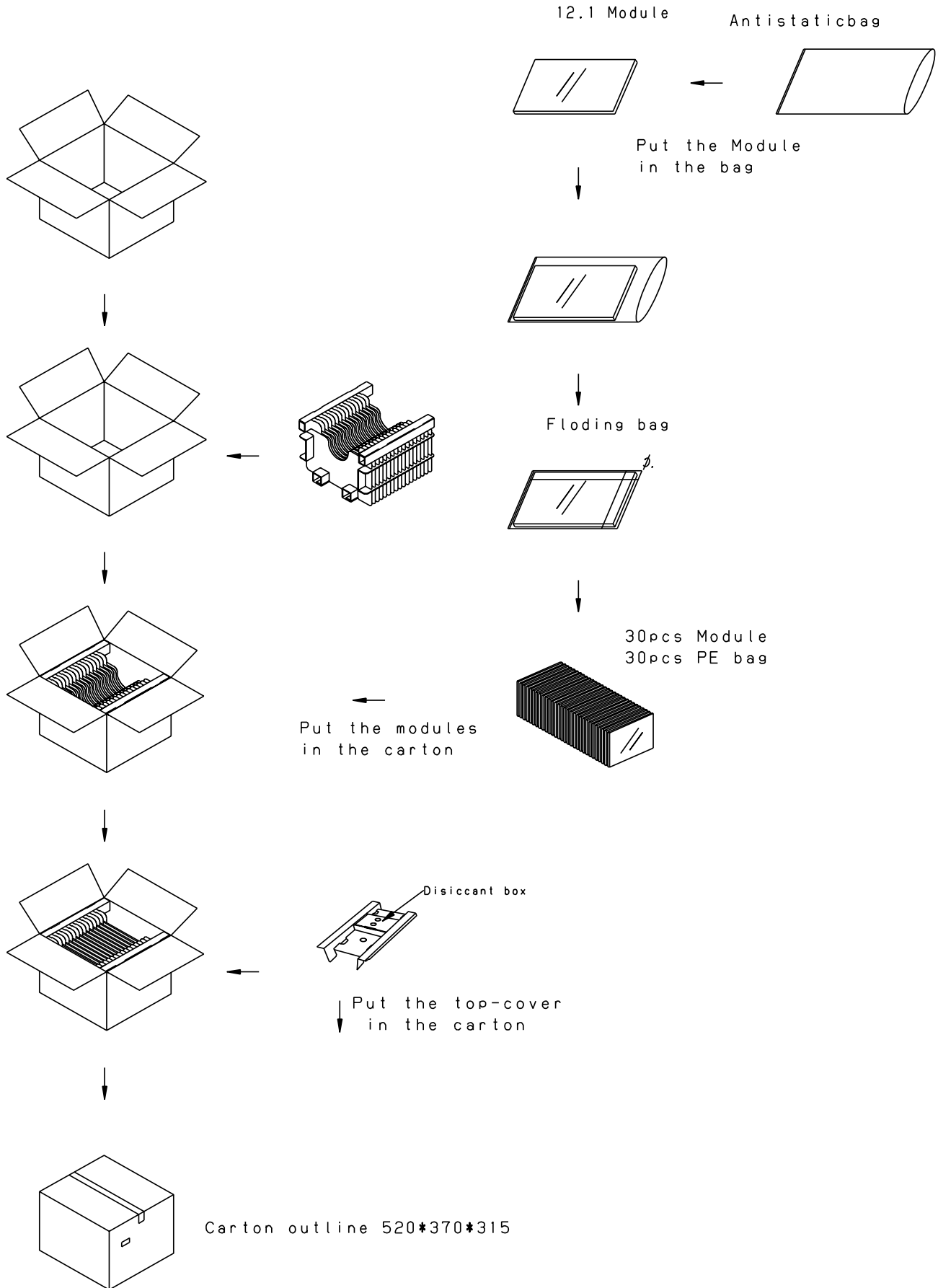

Fig.3 : PACKING FORM



**Distributor of Sharp Microelectronics: Excellent Integrated System Limited**

Datasheet of LQ121S1LG88 - LCD TFT 12.1" 800X600 SVGA

Contact us: [sales@integrated-circuit.com](mailto:sales@integrated-circuit.com) Website: [www.integrated-circuit.com](http://www.integrated-circuit.com)

---

## **Mouser Electronics**

Authorized Distributor

Click to View Pricing, Inventory, Delivery & Lifecycle Information:

[Sharp Microelectronics:](#)

[LQ121S1LG88](#)