

Operating instructions

RYMASKON® 600-BACnet

RYMASKON® 600-Modbus

Room control unit with colour touch screen,
with BACnet or Modbus connection

Controller for controlling and regulating
temperature, fan, light (1 zone) and
blind (2 zones)



INSTALLATION AND COMMISSIONING

Commissioning is mandatory and may only be performed by qualified personnel! Please read these instructions prior to installation and commissioning, and comply with the specifications that they contain!

Mounting shall take place while observing all relevant regulations and standards applicable for the place of measurement (e.g. such as welding instructions, etc.). It is particularly important to comply with the following:

- VDE / VDI technical temperature measurements, directives, measurement set-ups for temperature measurements.
- EMC directives
- It is imperative to avoid parallel routing of current-carrying lines
- We recommend the use of shielded cables with the shielding attached to the DDC/PLC at one side.

Before mounting, make sure that the existing technical parameters of the measuring instrument comply with the actual conditions at the place of utilization, particularly with regard to:

- the measuring range
- the maximum permissible temperature and humidity
- the protection type and protection class
- oscillation, vibration and impacts must be avoided (< 0.5 g)

Devices with integrated CO₂-Sensor

Devices with integrated CO₂-Sensor have **an automatic calibration of the carbon dioxide measurement - ABC logic**. The Automatic Background Logic is a self-calibrating mechanism that is suitable for use in applications in which the CO₂ concentration regularly drops to fresh air level (350 - 500 ppm). This should typically happen at times during which the rooms are unoccupied. The sensor reaches its normal accuracy after 24 hours of continuous operation in an environment which has been exposed to a fresh air supply of 400 ppm CO₂. The deviation error remains minimal with at least 4 cases of sensor exposure to fresh air within 21 days. The ABC logic requires continuous operating cycles of longer than 24 hours in order to function properly.

IMPORTANT NOTES

Only the valid edition of our conditions and the valid "General Conditions for the Supply of Products and Services of the Electrical and Electronics Industry" (ZVEI conditions) and the supplementary clause "Extended Retention of Title" apply as the terms and conditions regulating this purchase.

The following points must also be complied with:

- These instructions must be read before installation and commissioning, and all of the specifications that they contain must be complied with.
- The units must only be connected to an extra-low safety voltage in a de-energised condition. Use shielded cables to avoid damage to the unit and faults (e.g. resulting from voltage induction), avoid parallel routing with live lines, and comply with the EMC directives.
- This unit must only be used for its intended purpose, whereby the applicable VDE safety regulations and all regulations issued by the regional and national regulatory authorities, TÜV and local energy providers must be complied with. The purchaser must ensure that the relevant building and safety regulations are complied with, and must avoid hazards of all kinds.
- No warranty or liability whatsoever will be accepted for defects and damage arising from improper use of this unit.
- The warranty and liability excludes consequential damage caused by a fault in this unit.
- The units must only be installed and commissioned by qualified personnel.
- Only the technical data and connecting conditions specified by the installation and operating instructions which are included in the scope of delivery of the unit apply. Deviations from the depictions contained in the catalogue are not additionally listed, and are possible as a result of technical progress and the continuous improvement of our products.
- Any alterations made to the unit by the user will void the warranty.
- This unit must not be installed close to sources of heat (e.g. radiators) or their heat flow. Avoid direct solar irradiation or heat radiation from similar sources (powerful lamps, halogen spotlights).
- Operating this unit close to other devices that do not comply with EMC directives may influence the functionality thereof.
- This unit must not be used for monitoring purposes which serve the purpose of protecting persons against hazards or injury, as an Emergency Stop switch on systems or machinery, or for any other similar safety-related purposes.
- The housing dimensions and the dimensions of accessories may differ slightly from the specifications of these instructions.
- Changes to these documents are not permitted
- In cases of complaint, we will only accept complete units returned in their original packaging.

INSTALLATION

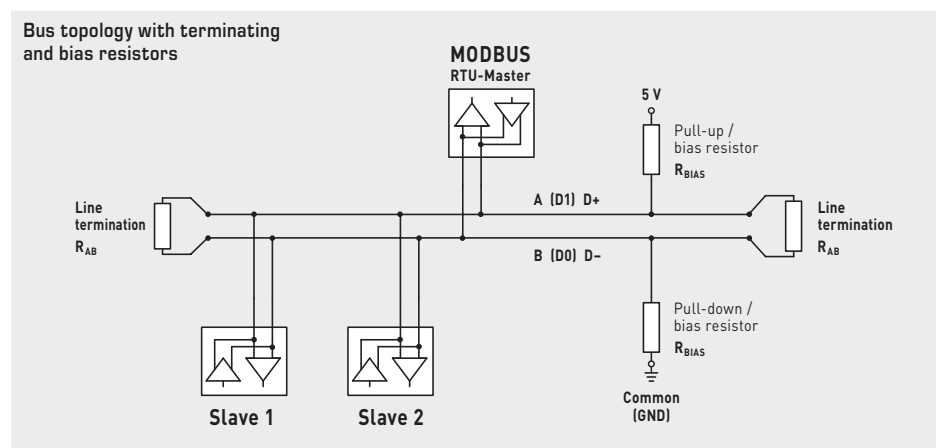
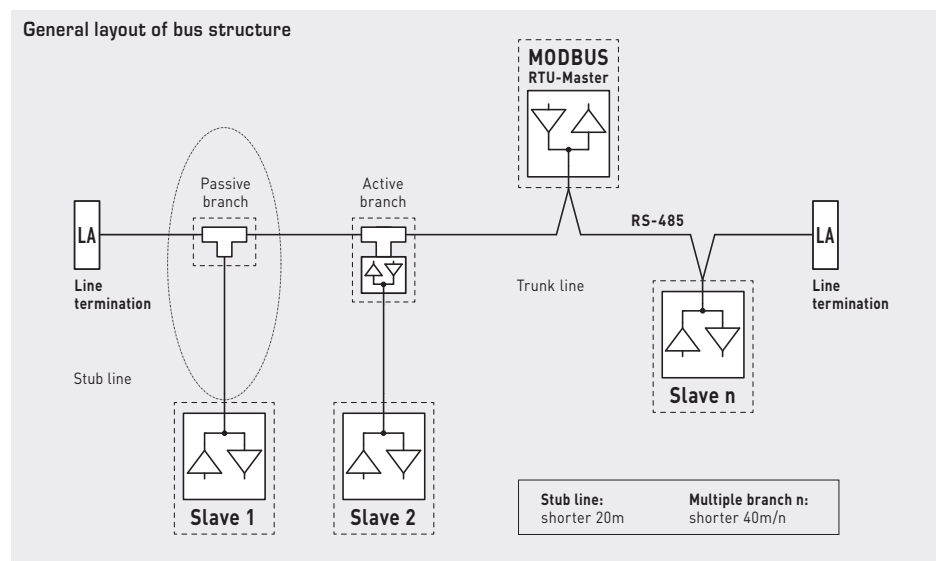

Terminating resistors may only be installed at the ends of the bus line.

No more than two line terminators are permitted in networks without repeaters.

The bias resistors for bus level definition in the idle state are usually activated at the Modbus master / repeater.

The maximum number of subscribers per Modbus segment is 32 devices.

With a greater number of subscribers, the bus must be subdivided into several segments separated by repeaters. The subscriber address can be set from 1 to 247.

A cable with a twisted-pair data line / power supply line and copper shielding braid must be used for the bus line. The line capacitance should be less than 100 pF/m (e.g. Profibus cable).

CONFIGURATION

The communication interface must be configured from the unit (see parameter table - System page 42). All other parameters can also be changed via the Modbus master.

Changed communication parameters are activated when Setting Mode is exited; the unit performs a soft reset. Alternatively, the new settings can also be activated by switching the unit off and on again (deactivate and reactivate supply voltage).

The configuration parameters are stored in the non-volatile memory of the controller.

After changing the configuration via the display, the new parameters are saved when the controller returns to Normal Display Mode.

If the changes were made via the bus (Modbus), the parameter for updating the non-volatile memory is required in order to force saving. If configuration takes place via the display, the parameters are saved after an expiry time or when the settings menu is closed.

An **existing configuration** can be **transferred** to other units using the **RYMASKON USB-CT** configuration tool (see next page).

RYMASKON USB-CT

Configuration tool for rapid transfer of the unit configuration



A configuration can be transferred to other units. To do so, a unit must first be configured using the display via the bus.

After which the **RYMASKON USB-CT** and software on the PC can be used to transfer the configuration to other units.

The current software and detailed information are available in the **RYMASKON USB-CT** download area (spluss.de/r/2L6VM.htm).

Connection plan of the configuration tool

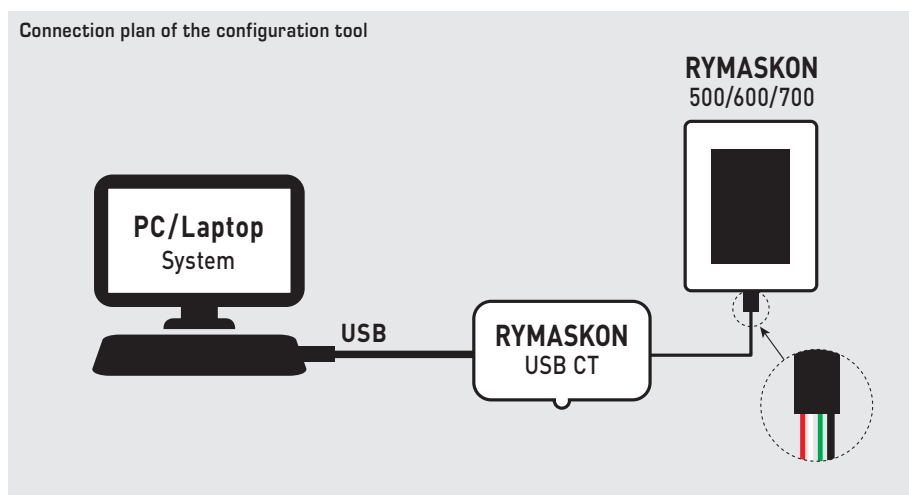

KEY FEATURES

Basic model Typ 610

- 24 V AC/DC voltage supply
- 3.5 inch touch display with background lighting
- Modbus or BACnet
- Wall mounting on standard in-wall flush boxes
- Integrated temperature sensor (basic equipment)
- Integrated humidity sensor
- Integrated CO2 sensor (optional)
- Regulation of heating, cooling, fan directly through analogue outputs (0–10 V)
- Operation of temperature, fan, light (1 zone), and sun protection (2 zones) via touch display
- 3 analogue outputs (0–10 V) for controlling heating/cooling valves and EC motor
- 2 analogue inputs (0–10 V) for external sensors
- 1 digital input (potential-free)
- Operating modes Comfort (Normal), OFF, Party (Boost), ECO, Frost Protection

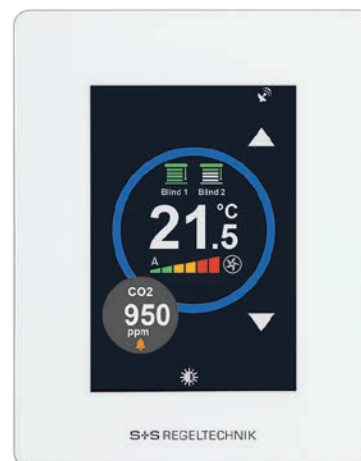
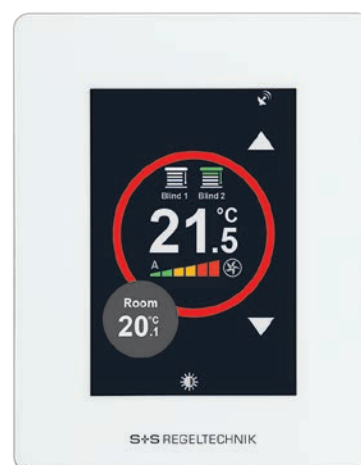

DESCRIPTIONIntroduction and
technical data

The RYMASKON® 500 / 600 / 700 series of room control units are designed for controlling the climatic zone in residential, hotel and office rooms and individually regulate the heating/cooling steps of the internal rooms. A colour touch display with modern icons is used for the visual display and operation at the location. The product range is characterised by the variety of combination options of the individual components.

The RYMASKON® 600 Controller series regulates through analogue outputs (0–10 V) up to two **heating or cooling valves** (6-way valves can also be controlled) and the **fan** (EC ventilator).

The **sun protection** (blinds, shutters) can be controlled in two zones via the bus. Through the appropriate symbols, it is possible to control the **light** instead of the sun protection.

In addition to the integrated temperature sensor, two external temperature sensors (NTC10K) or two analogue sensors (0–10 V) can also be connected. Measuring elements for relative humidity and CO₂ are also available. The devices are used in room climate technology, including convector fans, cooling ceilings and heating/cooling systems. Wall mounting is performed on standard in-wall flush boxes. The devices are optionally available with a Modbus or BACnet communication interface and in various type versions (see number key).

The basic model RYMASKON® 610 Controller with colour touch display (3.5"), in a white housing, possesses an integrated temperature and humidity sensor (CO₂ sensor optional), 2 analogue inputs for external sensors (0–10 V), 1 digital input, 3 analogue outputs (0–10 V), and optionally with Modbus or BACnet connection. The room control units are used for controlling temperature, fan, light (1 zone) and sun protection (2 zones) directly via the analogue outputs or via the bus.

TECHNICAL DATA	(Basic model)
Device type:	room control unit with controller
Functions:	temperature, fan, light (1 zone), and sun protection (2 zones)
Communication:	Modbus RTU Slave address range can be configured between 1...247 or BACnet MS/TP device ID 65100 (default) and MAC address can be configured between 1...127 RS 485 interface, max. 63 devices, 9600 / 19200 / 38400 / 57500 / 76800 Baud, none / even / odd parity, 1 / 2 stop bits
Power supply:	24 V AC/DC (± 15%)
Power consumption:	max. 1.92 W
Inputs:	2 analogue inputs 0–10 V 1 digital input (potential-free), Impedance <1 kOhm
Outputs:	3 analogue outputs 0–10 V (heating, cooling, fan) input impedance > 100 kOhm
Operating mode:	Comfort, ECO, OFF, Boost, Frost Protection
Control element:	3.5" touch display with backlighting, cut-out approx. 50 x 75 mm, resolution 320 x 480 pixels, 255,000 colours
TEMPERATURE	
Sensor:	integrated temperature sensor
Measuring range:	–40...+125 °C
Accuracy:	typically ±0.5 °C at +25 °C
HUMIDITY	
Sensor:	integrated humidity sensor
Measuring range:	0...100 % r.H.
Accuracy:	typically ±2 % r.H. (20...80 % r.H.) at +25 °C
CARBON DIOXIDE (CO₂)	
Sensor:	optical NDIR sensor (non-dispersive infrared technology), with automatic calibration
Measuring range:	0...5000 ppm
Accuracy:	typically ±50 ppm ±3% of the measured value at +25 °C
Electrical connection:	0.14–1.5 mm ² , via screw terminals
Housing:	plastic, polycarbonate material, self-extinguishing, white colour (optionally black or chrome), weight approx. 220 g
Housing dimensions:	approx. 88 x 112 x 14.5 mm (on-wall) approx. 88 x 112 x 20.5 mm (on-wall with CO ₂ sensor) approx. 52 x 53 x 28.5 mm (in-wall)
Mounting:	wall mounting on in-wall flush box, Ø 55 mm
Ambient temperature:	0...+50 °C (operation); –30...+70 °C (storage)
Permitted humidity:	0...95 % r. H., (non-precipitating air)
Protection type:	IP 20 (according to EN 60 529)
Standards:	CE conformity, according to EMC directive 2004/108/EU, Low-Voltage directive 2006/95/EU, according to EN 61000-6-1/3, EN 60730-1, EN 6100-4-2/4/5/11

RYMASKON® 600 Controller (series)

Number key for type versions

RYM6-x0Cx-2xxx-000

- Pos. 1-4** **Type name**
RYMASKON 600
- Pos. 5** **Channel configuration**
Type 610 **2RI, 1DI, 3AO** (h,c,f)
Type 620 **1RI, 1DI, 2AO** (h,c), **3RO** (f) 0.5 A
Type 630 **1RI, 1DI, 2AO** (h,c), **3RO** (f) 7A
Type 640 **2RI, 1DI, 1AO** (f), **2DO** (h, c, PMW)
Type 650 **2RI, 1DI, 1AO** (EC-f), **4RO** (h,c,f) 0.5 A
Type 660 **2RI, 1DI, 2DO** (h, c, PMW), **3RO** (f) 7 A
- Pos. 7** **Device type**
Controller
- Pos. 8** **Communication**
Modbus
BACnet
- Pos. 9** **Voltage supply**
24 V AC/DC
- Pos. 10** **Additional measuring elements**
without *
RH (rel. humidity)
CO2 (carbon dioxide)
RH + CO2
- Pos. 11** **Extra options**
without
AI instead of **RI**
- Pos. 12** **Housing colour**
black
white
chrome

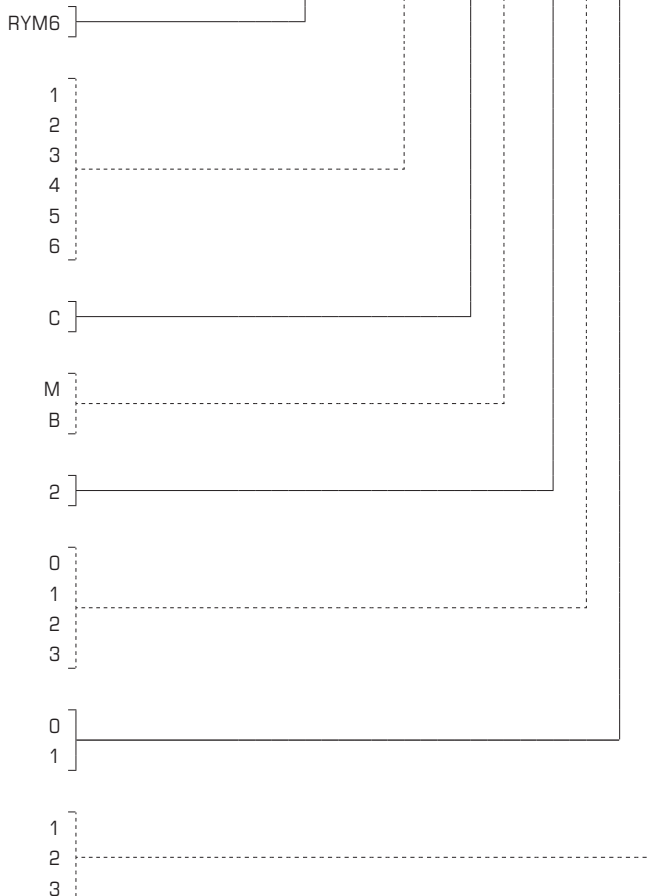

<p>Pos. 5</p> <p>RI Resistance input (NTC10K)</p> <p>RO Relay output (0.5 A / 7 A)</p> <p>AI Analogue input (0–10 V DC) instead of RI</p> <p>AO Analogue output (0–10 V DC)</p> <p>DI Digital input (potential-free)</p> <p>DO Digital output (potential-free)</p>	<p>(h) Heating</p> <p>(c) Cooling</p> <p>(f) Fan</p> <p>(EC-f) EC fan</p> <p>(PMW) Pulse Width Modulation</p>	<p>Pos. 10 * The temperature sensor forms part of the basic equipment and is included in the option "without" additional measuring elements.</p>
---	---	---

RYMASKON® 610 Controller (basic model)

Type / WG02	Communication	Measuring element	Control system	Colour	Display	Item No.
Rymaskon 612-MOD-RH-AI	Modbus	T RH	T V 2S L	white	■	RYM6-10CM-2112-000
Rymaskon 612-MOD-RH-CO2-AI	Modbus	T RH CO2	T V 2S L	white	■	RYM6-10CM-2312-000
Rymaskon 612-BAC-RH-AI	BACnet	T RH	T V 2S L	white	■	RYM6-10CB-2112-000
Rymaskon 612-BAC-RH-CO2-AI	BACnet	T RH CO2	T V 2S L	white	■	RYM6-10CB-2312-000
Measuring element / control system:	T = Temperature sensor (basic equipment) RH = Humidity sensor CO2 = Carbon dioxide sensor		T = Temperature V = Fan S = Sun protection (2 zones) L = Light			
Channel configuration:	2AI 2 analogue inputs (0–10 V DC) instead of 2RI 1DI 1 digital input (potential-free) 3AO 3 analogue outputs (0–10 V DC) for heating, cooling, fan					
Type variants:	Basic model Typ 610 available from stock – freely configurable type variants available upon request! For configuration options, see number key (above).					

ACCESSORIES

RYMASKON USB_CT	Configuration Tool for quick transfer of the device configuration from the PC to all devices in the building	1901-51Z3-0002-000
-----------------	--	--------------------

DIMENSIONAL DRAWING

Dimensional drawing
 [mm]

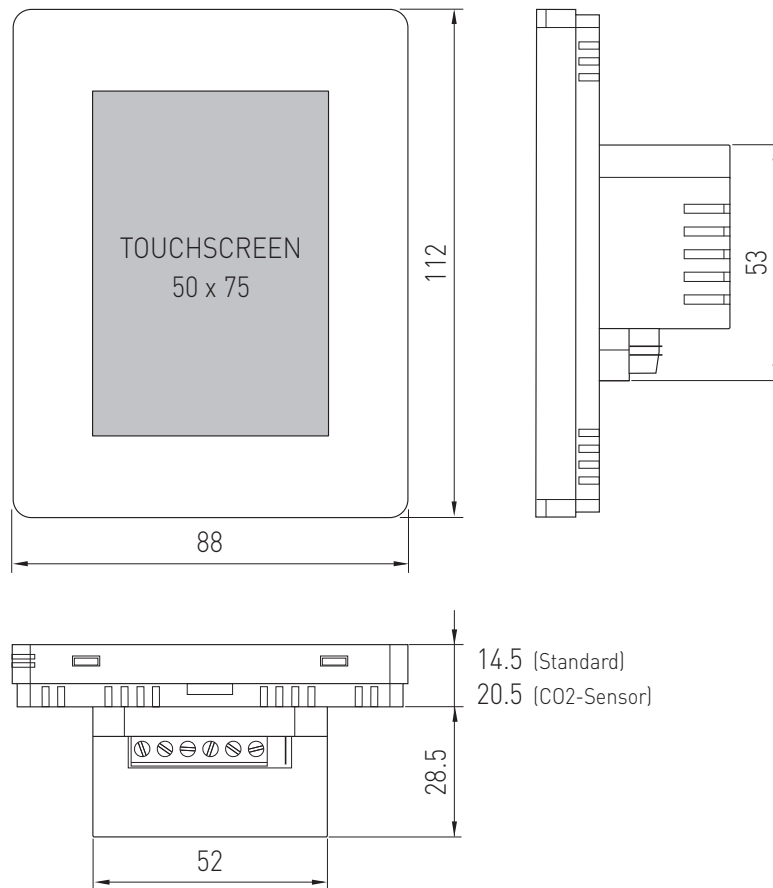

WIRING

Connection diagram
Typ 610
 (Basic model)

WARNING:

Switch off the power supply before commencing the wiring work!

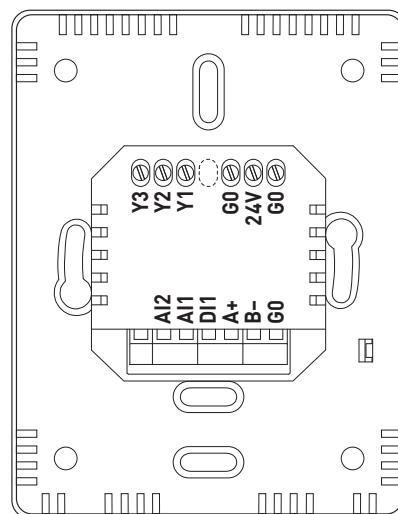

RYMASKON 610

0..10V DC Analogue Outputs

- Y1** AO1 – default fan speed
- Y2** AO2 – default heating stage 1
- Y3** AO3 – default cooling stage 1

24V 24V AC/DC Supply

G0 GND

0-10V Analogue Inputs

- A11** Analogue Input 1 (RI optional)
- A12** Analogue Input 2 (RI optional)

D11 Digital Input (potential-free)

Modbus / BACnet MS/TP

A+ RS485 A+

B- RS485 B-

Connection diagram

Typ 620 (0.5A)

Typ 630 (7A)

WARNING:

Switch off the power supply before commencing the wiring work!

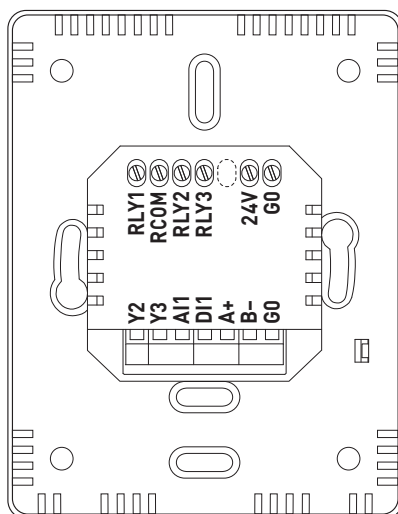

RYMASKON 620

230V 0.5A Relay Outputs

RYMASKON 630

230V 7A Relay Outputs

- RLY1** R01 – fan speed 1
- RLY2** R02 – fan speed 2
- RLY3** R03 – fan speed 3
- RCOM** Relay Common
- 24V** 24V AC/DC Supply
- G0** GND
- 0..10V DC Analogue Outputs
- Y2** AO2 – default heating stage 1
- Y3** AO3 – default cooling stage 1
- 0-10V Analogue Input
- A11** Analogue Input 1 (RI optional)
- DI1** Digital Input (potential-free)
- Modbus / BACnet MS/TP
- A+** RS485 A+
- B-** RS485 B-

Connection diagram

Typ 640

WARNING:

Switch off the power supply before commencing the wiring work!

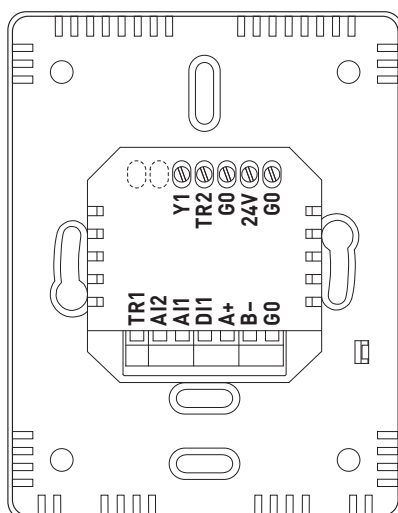

RYMASKON 640

- 0..10V DC Analogue Output
- Y1** AO1 – default fan speed
- 24V AC 1A Triac (switched to 0V – G0)
- TR1** Triac1 (DO1) – default heating PWM
- TR2** Triac2 (DO2) – default cooling PWM
- 24V** 24V AC/DC Supply
- G0** GND
- 0-10V Analogue Inputs
- A11** Analogue Input 1 (RI optional)
- A12** Analogue Input 2 (RI optional)
- DI1** Digital Input (potential-free)
- Modbus / BACnet MS/TP
- A+** RS485 A+
- B-** RS485 B-

Connection diagram
 Typ 650

WARNING:
 Switch off the power supply before commencing the wiring work!

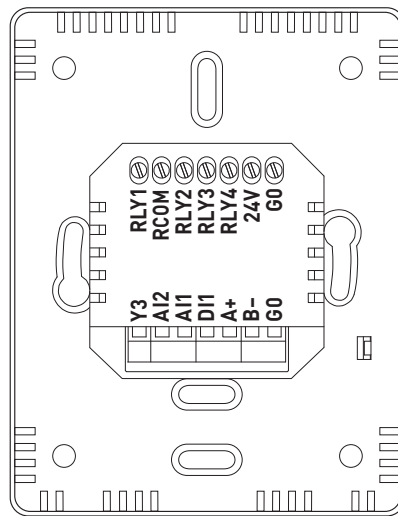

* Alternatively, relay 3 (**RLY3**) can be configured for another on-off valve (cooling stage 1) and the 0...10V output (**Y3**) for an EC fan.

RYMASKON 650

230V 0.5A Relay Outputs

- RLY1** R01 – fan speed 1
- RLY2** R02 – fan speed 2
- RLY3** R03 – fan speed 3*
- RLY4** R04 – on-off valve – default heating stage 1
- RCOM** Relay Common
- 24V** 24V AC/DC Supply
- G0** GND
- 0..10V DC Analogue Output
- Y3** A01 – default cooling stage 1*
- 0-10V Analogue Inputs
- AI1** Analogue Input 1 (RI optional)
- AI2** Analogue Input 2 (RI optional)
- DI1** Digital Input (potential-free)
- Modbus / BACnet MS/TP
- A+** RS485 A+
- B-** RS485 B-

Connection diagram
 Typ 660

WARNING:
 Switch off the power supply before commencing the wiring work!

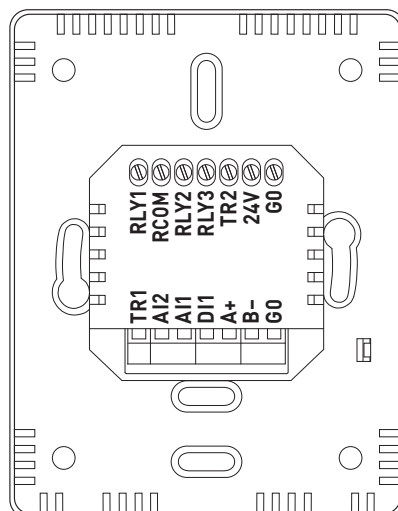

RYMASKON 660

230V 7A Relay Outputs

- RLY1** R01 – fan speed 1
- RLY2** R02 – fan speed 2
- RLY3** R03 – fan speed 3
- RCOM** Relay Common
- 24V** 24V AC/DC Supply
- G0** GND
- 24V AC 1A Triac (switched to 0V – G0)
- TR1** Triac1 (DO1) – default heating PWM
- TR2** Triac2 (DO2) – default cooling PWM
- 0-10V Analogue Inputs
- AI1** Analogue Input 1 (RI optional)
- AI2** Analogue Input 2 (RI optional)
- DI1** Digital Input (potential-free)
- Modbus / BACnet MS/TP
- A+** RS485 A+
- B-** RS485 B-

APPLICATION EXAMPLES

The figures below illustrate some sample use cases with A/C controllers of the **RYMASKON® 610 Controller** series.

These controllers are very versatile and can easily be configured for the majority of room heating and cooling tasks, including fan, blower, cooling ceiling and zone heating control.

Please note the setting options described on the following pages; in case of questions, please contact our sales team.

4-PIPE CONVECTOR UNIT CONTROL WITH MODULATING EC FAN

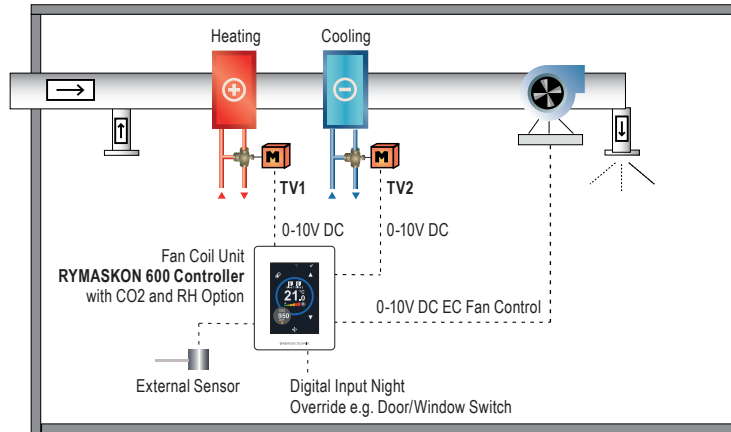

COOLING CEILING AND ZONE HEATING APPLICATION WITH FAN FOR FRESH AIR SUPPLY

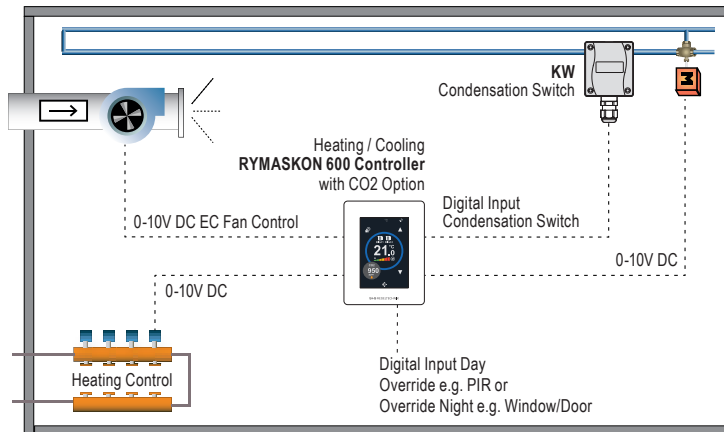

USER INTERFACE

Screens, lighting
and calibration

The following diagrams are typical display options for the **RYMASKON® 600 controller**. The multi-colour LCD touch display facilitates making the required settings and visualises the actual state of the controlled system with easily understandable icons.

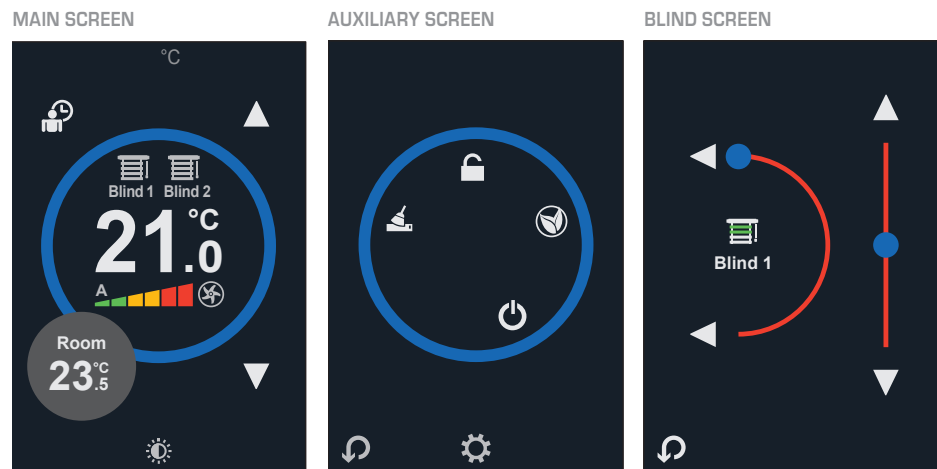

Fig. 1a Main screen

Fig. 1b Auxiliary screen
(opens by tapping the grey action circle on the main screen)

Fig. 1c Blind screen
(opens by tapping the Blind icon on the main screen)

The small **action circle** (grey) alternately displays the current sensor values (if enabled).

The large **setpoint ring** illustrates the heating or cooling consumption (red/blue).

If temperature control is in the "dead zone", the ring is white.

The colour intensity changes depending on the difference between the actual temperature and the currently controlled heating/cooling temperature (setpoint). From a delta of 2°C (3.6°F) or more, the entire ring is red/blue.

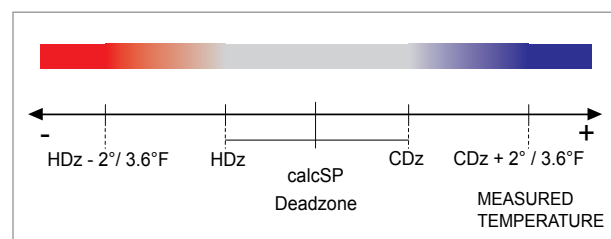

Screen backlighting (standby)

If the display of the main screen is not touched for 30 sec., the display will be dimmed to the configured standby value (default 5/max. 20).

Use the settings to adjust the brightness of the touch display (System – Brightness). If this value is configured to 0, the display is completely dark when it is inactive. Touch the display to automatically re-enable the backlighting.

Tap the  icon on the **main screen** to immediately dim the display to the set value. Tap the icon again in standby to completely switch off backlighting.

Screen calibration

The touch display can be re-calibrated during a unit reset.

The unit performs the following two types of resets:

1. When the unit starts up (power supply present)
2. After completing parameter configuration in setting mode and returning to the main screen.

During reset (dark screen), swipe in the direction of all four edges of the display and then follow the instructions. Confirm recalibration with "OK".

MAIN SCREEN ICONS

Screen areas and explanation of icons

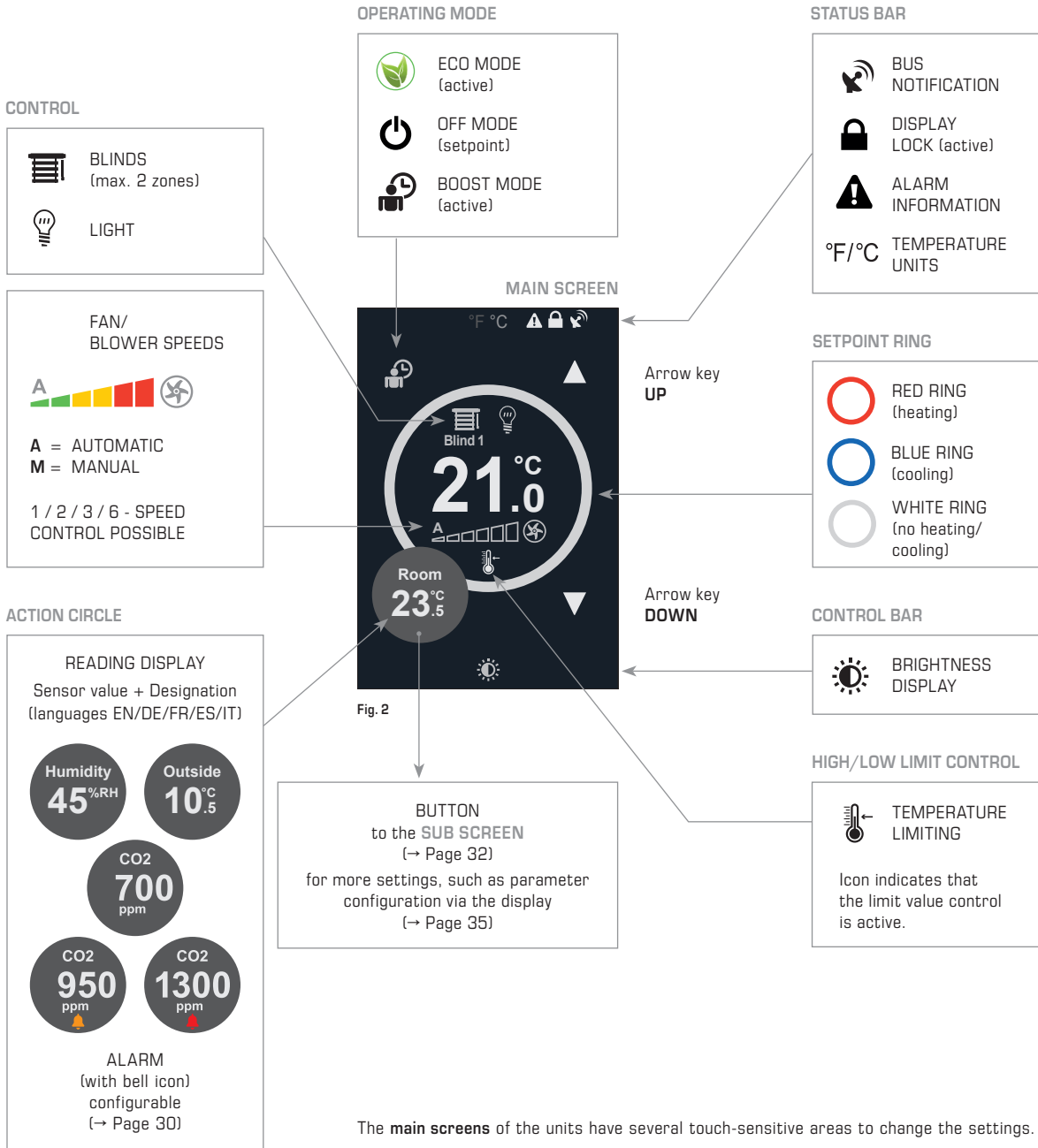

The **main screens** of the units have several touch-sensitive areas to change the settings.

- Arrow keys **UP ▲** and **DOWN ▼** to change the current setpoint (temperature/percentage).
- Small **action circle** to display the measured temperature, the CO2 and humidity content of the air and as a button to access the sub screen.
- Function-based toggle icon shows the **OFF icon** in OFF mode and the **ECO icon** in ECO mode to cancel the respective modes.
- The **boost icon** enables a time-controlled boost phase if boost mode is active.
- **Fan icon** and blower bar to display and change the fan speed in up to 7 blower speeds (Auto-1-2-3-4-5-6), if released.
- **Blinds icon** as a button to access the blinds screen to control the blinds (OPEN/CLOSE) and the slats' angle of inclination.
- **Lights icon** to switch ON/OFF and to change the light intensity of the room lighting, if released.

TEMPERATURE UNIT

Selection of degrees Celsius (°C) or degrees Fahrenheit (°F)

WARNING!

Changing the default setting for the temperature unit will set the defaults for all other parameters.

Changing the default setting for the temperature unit is intended to be performed as necessary at the start of commissioning.

If the icon for switching between °C /°F is enabled (Settings - Display - Show Unit Swap - Enabled), the temperature displays can be switched between degrees Celsius and Fahrenheit by tapping the icon on the main screen.

This option is especially useful for applications in hotels etc. with international guests.

You can also determine which temperature unit (°C /°F) is set as the default value on the unit in the settings (Systems, Native Units).

If the unit default setting is changed, the unit will reload the factory default settings with the changed unit for all temperature displays.

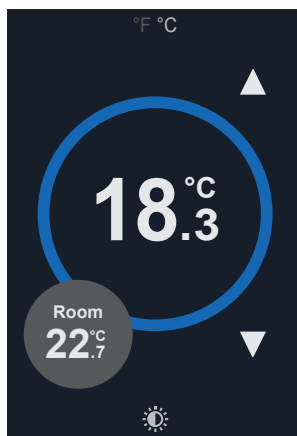

Fig. 3a Temperature in °C

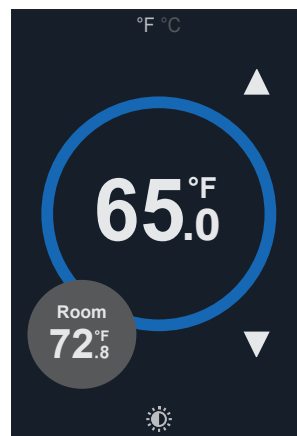

Fig. 3b Temperature in °F

TEMPERATURE CONTROL CIRCUIT

Temperature Control Loop Operation

The controllers can control up to two heating and cooling stages. The default is one heating and one cooling stage. Furthermore, use the digital input, the measured temperature or the bus to automatically switch between heating and cooling mode (Changeover). This allows various control configurations:

- 1-/2-step heating control
- 1-/2-step cooling control
- 1-/2-step heating control and 1-/2-step cooling control (up to 3 outputs)
- 1-/2-step heating/cooling control (with automatic switching – Changeover)

The controller modulates the required output capacity for heating and cooling depending on the calculated target and actual temperature using P or PI control. The calculated target temperature consists of the nominal target temperature plus the adjustment made by the user.

In the preferences of the **RYMASKON® 610/620/630** controllers, the output capacity for **heating stage 1** is linked to analogue output **Y2** (0–10VDC control) and the output capacity for **cooling stage 1** is linked to analogue output **Y3** (0–10VDC control).

RYMASKON® 640/660 controllers have their **heating stage 1** linked to digital output **DO1** (PWM control) and their **cooling stage 1** linked to digital output **DO2** (PWM control).

The control circuits can be configured to directly or inversely control the outputs. In inverted mode, the output and/or the valve is regulated from 100 % to 0 %. This can be set separately for each stage in the configuration parameters.

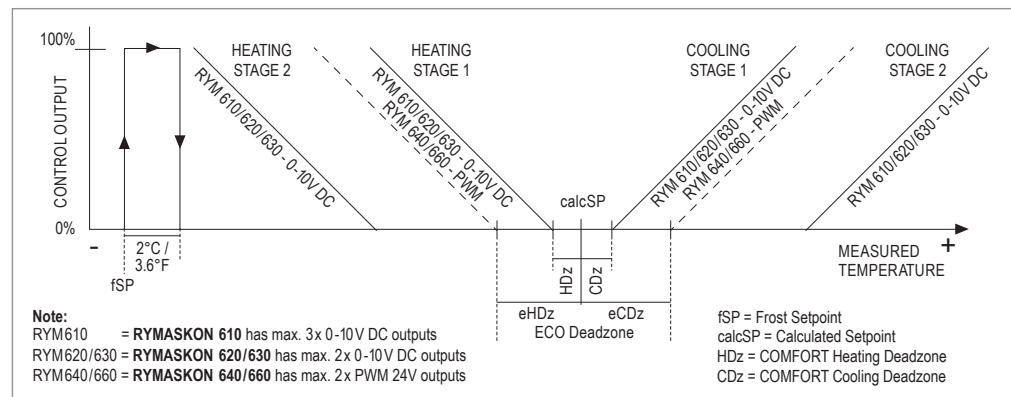

There is a "dead zone" (**HDz+CDz**) between heating stage 1 and cooling stage 1. P control in the "dead zone" results in a heating and cooling consumption of 0 %. PI control in the "dead zone" regulates the heating and cooling consumption to 0 % if the actual temperature is in that range for a longer period of time. The "dead zone" tolerates variations in the target temperature range without opening the heating or cooling valves. The controller has an integrated lock preventing simultaneous heating and cooling consumption.

Use **HDz** (Heating Deadzone) and **CDz** (Cooling Deadzone) to asymmetrically set the "dead zone" left and right of the calculated setpoint **calcSP**. In some cases it may be important for the cooling process to respond more quickly than the heating process if the actual temperature deviates from the setpoint.

NOTE: Conceptually, **calcSP - HDz** is the effective target temperature for heating and **calcSP + CDz** the effective target temperature for cooling. It is easier for the user to configure and calculate a single setpoint. The dead zone limits are configured during commissioning to specify effective heating and cooling setpoints.

Users can adjust the target temperature using the arrow keys UP and DOWN. The target temperature/dead zone changes as follows depending on the operating modes:

- **Comfort mode (standard mode):** The target temperature is adjusted by the users or specified via the bus and shown on display. The calculated target temperature (**calcSP**) consists of the nominal target temperature and the setting adjusted by the user on the display. The dead zone is adjusted according to the parameters to "Heating DZ COMFORT" (**HDz**) and "Cooling DZ COMFORT" (**CDz**). The possible adjustment range is limited by the parameter "SP Adj. Max" and "SP Adj. Min." (default $\pm 3^{\circ}\text{C}$).
- **ECO mode:** The nominal target temperature remains unchanged. Adjustments made by users are disabled and the dead zone is adjusted to "Heating DZ ECO" (**eHDz**) and "Cooling DZ ECO" (**eCDz**) according to the parameters.
- **OFF mode:** The control ensures that the configured antifreeze-setpoint is met (**fSP**). Adjustments made by users are disabled.

NOTE: If limit value control is enabled, the set upper and lower limits move the effective and/or calculated target temperature as required (see chapter "Limit value control").

CHANGEOVER

Summer/winter mode
in one line

*Heating/Cooling
ChangeOver*

The main temperature control circuit of heating and cooling stages 1 can be forcibly switched to heating or cooling mode via the bus (Changeover).

This makes it possible to use the same pipe for heating and cooling in different seasons (summer / winter mode).

Configure and perform the switching to the following values:

- **Digital input** (Digital Input Mode)
- **Temperature measurement R11/R12** (R11/R12 Mode)
- **Bus** (Changeover function)

If R11/R12 is selected, the system switches automatically at the set temperature limits "Changeover High" (default: 25 °C) and "Changeover Low" (default: 20 °C)

NOTE: If the unit has analogue inputs **A11/A12** instead of **R11/R12**, Changeover is only possible via the digital input or the bus.

LIMIT VALUE CONTROL

High/Low Limit Control

If an **external temperature sensor** is connected (to R11 or R12) and if the input is parameterised to "Floor (NTC10K)" (see chapter "Modes for inputs R11 and R12"), the controller can be used for limit value control via **High Limit Setpoint** (default: 35 °C) and **Low Limit Setpoint** (default: 16 °C).

This function is enabled via the parameter "Limit Ratio" (default: 0.0 = limit value control disabled).

For controls with the **upper limit value** (High Limit Setpoint), the target temperature of the main control is reduced by the set value of the limit ratio if the temperature on R11/2 exceeds the upper limit value. Example: If the value 2 is set for limit ratio, the target temperature is reduced by 2 degrees for every degree over the high limit setpoint.

Control using the **lower limit value** works vice versa:

For every degree that the temperature undercuts the lower setpoint, the target temperature is increased by 2 degrees.

The value for the **target temperature reset** follows this formula:
 $\text{setpoint reset} = (\text{limit setpoint} - \text{actual temperature R11/2}) \times \text{limit ratio}$

NOTE: The target temperature shown on the display does not change during these increases/decreases. The temperature limiting icon  points to an active reset phase.

NOTE: The limit value control is enabled using the parameter "Limit Ratio" (default: 0.0 = disabled).

NOTE: In OFF mode, limit value control is disabled.

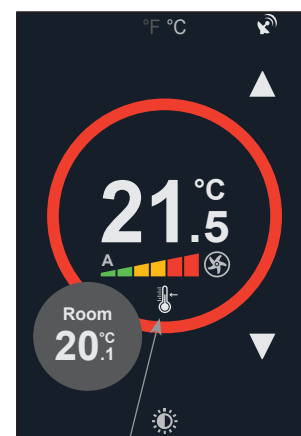
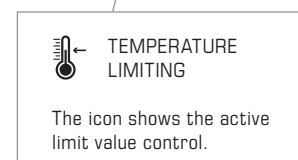

Fig. 4



ECO MODE

Display and setting of the ECO mode

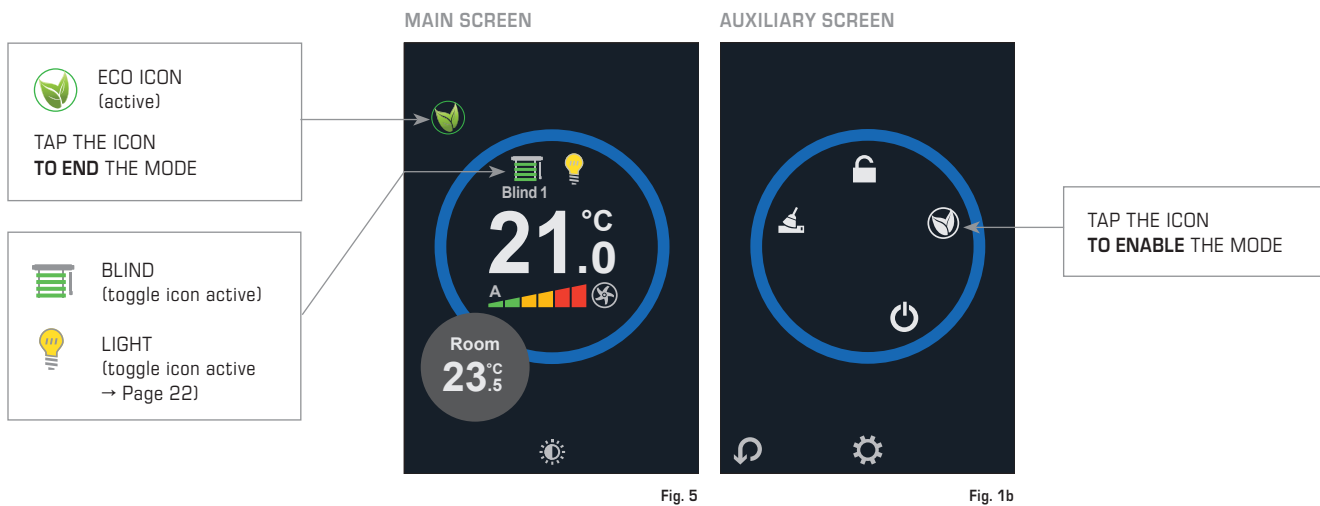

Fig. 5

Fig. 1b

Use the bus, the digital input (e.g., PIR) or the display to switch the controller into **ECO mode**.

The mode is **enabled** on the display via the **sub screen**; the mode is **disabled** via the **main screen**.

In ECO mode, the controller regulates the **temperature** in the ECO dead zone (eHDz + eCDz) range for heating and cooling (see diagram). Adjustments to the target temperature made by users are disabled.

In ECO mode, the control circuits for **CO2** and **humidity** are set to 0% (see chapter "CO2 and humidity control circuit").

Depending on the configuration, **lighting** in ECO mode is set to 0% (switched off) or the current value is maintained. If released, the toggle icon "Light" remains active (see chapter "Light").

The current position of the **blind** is maintained in ECO mode. If released, the "Blind" toggle icon remains active.

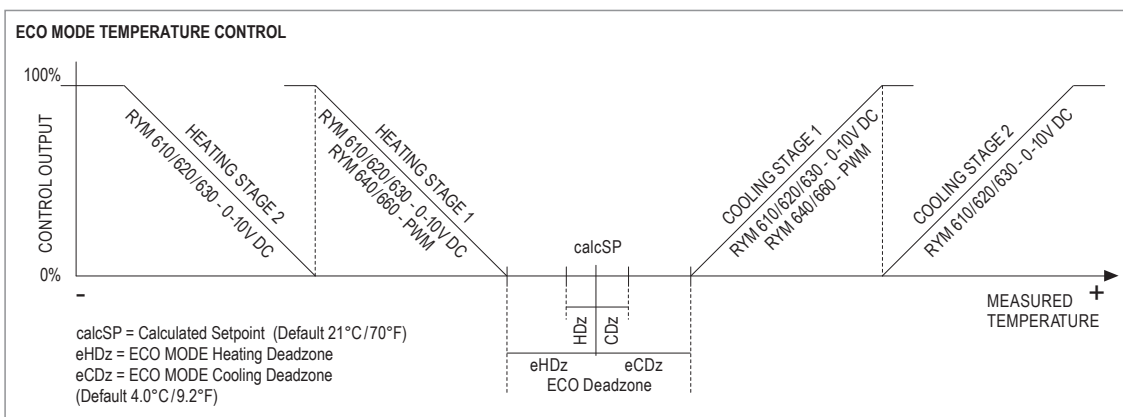

OFF MODE

Display and setting
of OFF mode

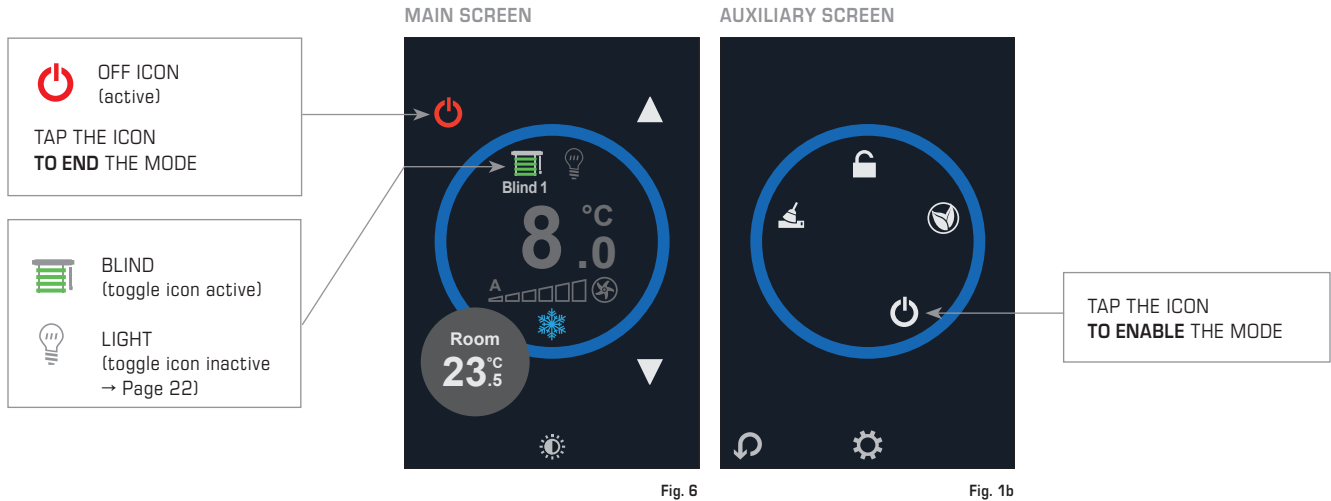

Fig. 6

Fig. 1b

Use the bus, the digital input (e.g., PIR) or the display to switch the controller into **OFF mode**.

The mode is **enabled** on the display via the **sub screen**; the mode is **disabled** via the **main screen**.

In OFF mode, the output capacity for **temperature, CO2, humidity** and **fan** are set to 0%.

Depending on the configuration, the **lighting** in OFF mode is set to 0% (switched off) and the toggle icon "Lights" is disabled (see chapter "Light").

The current position of the **blinds** is maintained in OFF mode. If released, the "Blind" toggle icon remains active.

If the room temperature in OFF mode drops below the antifreeze setpoint, **antifreeze** is enabled (see diagram).

The display shows the snowflake icon ❄️, the heating stages are set to 100% and the fan speed to 33%.

As soon as the temperature is 2 °C above the antifreeze setpoint, antifreeze is switched off.

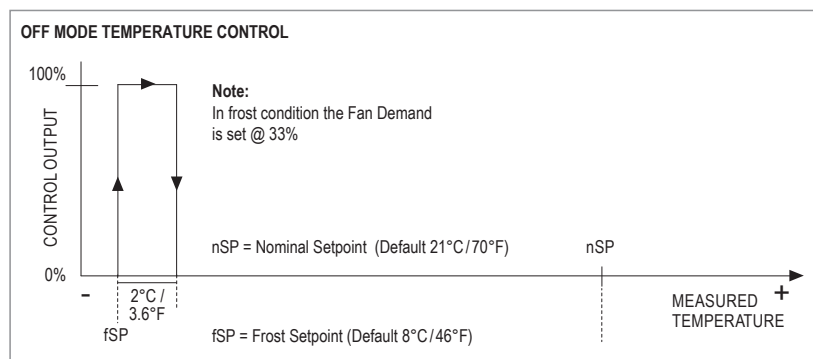

HUMIDITY CONTROL CIRCUIT

*Humidity Control
 Loop Operation*

(Units with RH option)

Units with **RH option** can measure and monitor the relative humidity in the room to control relevant applications on that basis and, e.g., increase the fresh air supply if humidity is high.

For humidification and de-humidification, the control circuit can be linked to any of the physical outputs (**Y1, Y2, Y3**) or the fan (fan speed source).

As an alternative, use the humidity control circuit together with the temperature control circuit to control the fan speed (**Max. Temp/Hum**, see chapter "Fan control").

The direction of both outputs can be inverted to regulate the actuators from 100 to 0% instead of from 0 to 100%. Use the configuration parameters to enable/disable the display of the humidity sensor.

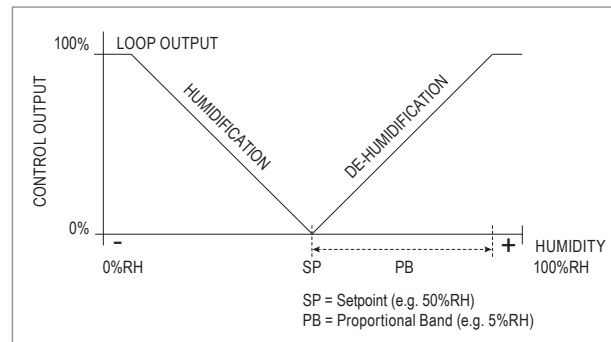

CO2 CONTROL CIRCUIT

*CO2 Sensor Control
 Loop Operation*

(Units with CO2 option)

Units with **CO2 sensor** can measure and monitor the CO2 content in the room air to control relevant applications on that basis and, e.g., increase the fresh air supply if the CO2 concentration is high. To lower the CO2 concentration, the control circuit can be linked to any of the physical outputs (**Y1, Y2, Y3**) or the fan (fan speed source). As an alternative, use the CO2 control circuit for maximum consumption control "**Max. VAV**" or "**Max. Fan**" (configurable in the parameters Y1, Y2, Y3 and fan speed source).

The CO2 control circuit corresponds to the CO2 setpoint and the CO2 proportional band. If configured for direct control (typical) and the CO2 content exceeds the setpoint (limit value), the control circuit will start to modulate the output capacity to 100%. If the CO2 content in the proportional band range is above the setpoint, output capacity is 100%. Use the parameter settings to configure the control circuit. It can also be configured for proportional and integral control (PI) by changing the integral reset time from 0 to a required higher value. Use the parameter "CO2 Dir." to change the direction of the actuator (direct, inverse).

In **OFF mode**, the output capacity of the CO2 control circuit is set to 0%.

In **ECO mode**, the CO2 control circuit works the same way as in standard mode.

Use the configuration parameters to enable/disable the display of the CO2 sensor.

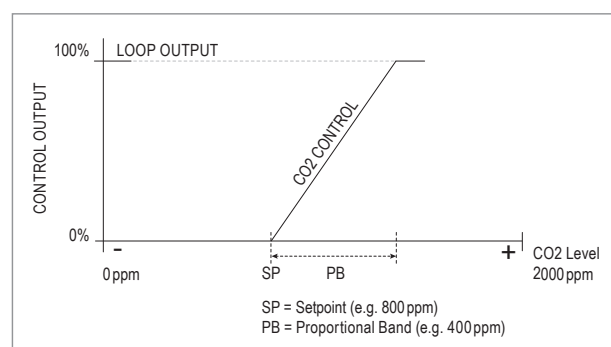

VAV maximum consumption (Max. Temp/CO2)

Each analogue output can be configured for "**Max. VAV**" (maximum volume flow). In that case, the relevant output (**Y1, Y2, Y3**) takes on the maximum consumption capacity of the CO2 and of the cooling temperature control circuit. Typically, this is used with consumption-controlled ventilation to open ventilation flaps when more fresh air is needed or to supply the room with fresh cooling air to lower the temperature.

Maximum blower consumption (Max. Temp/Hum)

Each analogue output can be configured for "**Max. Fan**". In that case, the relevant output (**Y1, Y2, Y3**) takes on the maximum consumption capacity of the CO2 and of the blower control circuit. If the CO2 content is high and if the blower control circuit consumption increases, this is a way to maximise the fan speed.

AUXILIARY CONTROL CIRCUIT

AUX Heating Control Loop

The controllers have an auxiliary control circuit for a **second zone**. This control circuit provides an additional PI control function for applications needing an additional control circuit. Use the AUX parameters in the settings or the bus to configure this additional control circuit.

To enable it, set "RI1 Mode" or "RI2 Mode " parameter to AUX control circuit.

To control the temperature in the second zone, assign the AUX control circuit to an analogue output (**Y1, Y2, Y3**). Use the bus (not the display) to control the auxiliary control circuit.

NOTE: RI2 is not available with **Type 620**.

BOOST

Display and setting of the boost mode

The controller has a **boost icon** (if released), and it can be linked to priority switching for a configurable boost time.

The **boost time** (timer) can be configured from 0 to 480 minutes (0 = permanently enabled, switch off boost using the display or the bus). The remaining time is shown on the touch display (Fig. 7a).

The following configuration options are possible:

- **Boost disabled** (*Disabled*)
- **Heating stage 1** (*Htg Stage 1*)
- **Heating stage 1 + heating stage 2** (*Htg Stages 1&2*)
- **Cooling stage 1** (*Clg Stage 1*)
- **Cooling stage 1 + cooling stage 2** (*Clg Stages 1&2*)
- **Humidification control circuit** (*Humidification*)
- **De-humidification control circuit** (*De-Humidification*)
- **CO2 control circuit** (*CO2*)
- **Fan**
- **Aux control circuit** (*Aux. Loop*)

Digital input boost (without timer)

If the digital input for boost mode was configured, you **cannot exit** the mode on the display and it remains active until the input status changes.

Digital input boost is shown with an icon and the **text "Boost"** (instead of the setpoint) in the large circle (Fig. 7b).

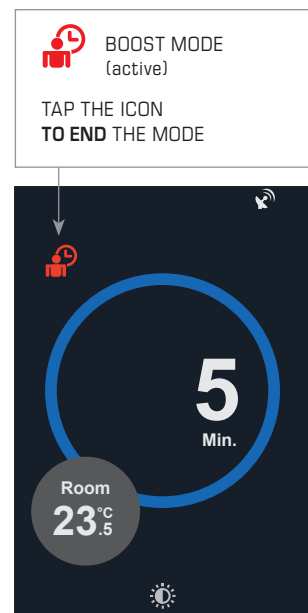

Fig. 7a Remaining boost time (timer in minutes)

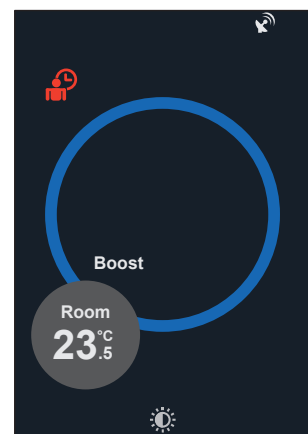

Fig. 7b Digital input boost (without timer)

**FAN
 ICONS AND DISPLAY**

Fan icon and line bar chart
 (blower speeds)

A = AUTO
M = MANUAL

TAP THE ICON TO SET MANUALLY (if released)

IF BLOWER IS ACTIVE, (SPEEDS 1-6), THE FAN ICON WILL ROTATE

MAIN SCREEN

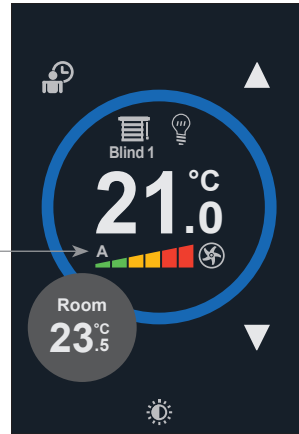

AUTO CONTROL

AUTOMATIC CONTROL (A = AUTO) CAN BE SELECTED VIA THE BUS OR ON THE UNIT.

Speed 0	A	0...8 %
Speed 1	A	8...25 %
Speed 2	A	25...41 %
Speed 3	A	41...58 %
Speed 4	A	58...74 %
Speed 5	A	74...92 %
Speed 6	A	92...100 %

Fig. 8

MANUAL CONTROL

<p>1 STEP + AUTO</p> <p>Speed 0 M</p> <p>Speed 1 M</p> <p>AUTO * A</p>	<p>3 STEP + AUTO</p> <p>Speed 0 M</p> <p>Speed 1 M</p> <p>Speed 2 M</p> <p>Speed 3 M</p> <p>AUTO * A</p>	<p>6 STEP + AUTO</p> <p>Speed 0 M</p> <p>Speed 1 M</p> <p>Speed 2 M</p> <p>Speed 3 M</p> <p>Speed 4 M</p> <p>Speed 5 M</p> <p>Speed 6 M</p> <p>AUTO * A</p>
<p>2 STEP + AUTO</p> <p>Speed 0 M</p> <p>Speed 1 M</p> <p>Speed 2 M</p> <p>AUTO * A</p>	<p>* CONTROLLED VIA THE BUS: UNIT SWITCHES TO "AUTO" AS SOON AS A NEW SPEED IS SPECIFIED VIA THE BUS.</p>	

MANUAL FAN SPEED CONFIGURATION OPTIONS

None	No display	
No Input	Display without manual adjustment	
0 - 1	ON/OFF	(1 STEP: 0 % - 100 %)
0 - 1 - 2	2 speeds	(2 STEP: 0 % - 50 % - 100 %)
0 - 1 - 2 - 3	3 speeds	(3 STEP: 0 % - 33 % - 66 % - 100 %)
0 - 1 - 2 - 3 - 4 - 5 - 6	6 speeds	(6 STEP: 0 % - 16 % - 32 % - 50 % - 66 % - 82 % - 100 %)

FAN CONTROL

Fan Speed Control

In "Auto Control", fan and/or blower control has been designed as a consumption control for output capacities from 0 to 100 %. You can adjust the fan speed to work depending on different system parameters. The following configuration options are possible for "Auto Control" (configurable in the "Fan Speed Source" parameter):

- Heating stage 1 + cooling stage 1 (Htg/Clg Stage 1)
- Heating stage 1 (Htg Stage 1)
- Cooling stage 1 (Clg Stage 1)
- Heating stage 2 + cooling stage 2 (Htg/Clg Stage 2)
- Heating stage 2 (Htg Stage 2)
- Cooling stage 2 (Clg Stage 2)
- CO2 control circuit (CO2)
- Humidification control circuit (Humidification)
- De-humidification control circuit (De-Humidification)
- Max. VAV, the higher consumption for cooling stage 1 and CO2 control
- Max. Temp/Hum, the higher consumption for heating stage 1, cooling stage 1 and (de-)humidification
- Aux control circuit (Aux. Loop)

The default is that the fan speed control follows the heating and cooling stages 1. This means that, e.g., if heating stage 1 works with an output capacity of 55 % and the "Min. fan speed" (Min. Fan Level) is set to 0 %, the fan speed is also regulated with an output capacity of 55 %. If the heating or cooling stages 1 reach the dead zone, the blower is switched off at the same time (0 %).

Use the parameters "Min. fan speed" (Min. Fan Level) and "Fan switch-off delay" (Fan Off Delay) to set a switch-off delay can for the dead zone in comfort mode (standard mode) where the fan continues to run for the set time at the set minimum fan speed. "0" (disabled) is set as default for both parameters.

See the following examples for an explanation of how "Minimum fan speed" (Min. Fan Level) and "Fan switch-off delay" (Fan Off Delay) work:

1. Example | Min Fan Level = 20 % | Fan Off Delay = 0 s

This configuration lets the fan run at 20% while the control circuit is in the dead zone.

2. Example | Min Fan Level = 20 % | Fan Off Delay = 10 s

This configuration lets the fan run at 20 % for 10 s as soon as the control circuit enters the dead zone.

When the 10 s have expired, the fan is regulated down to 0 %.

NOTE: Switch-off delay is only active if the minimum fan speed is configured to be greater than 0 %.

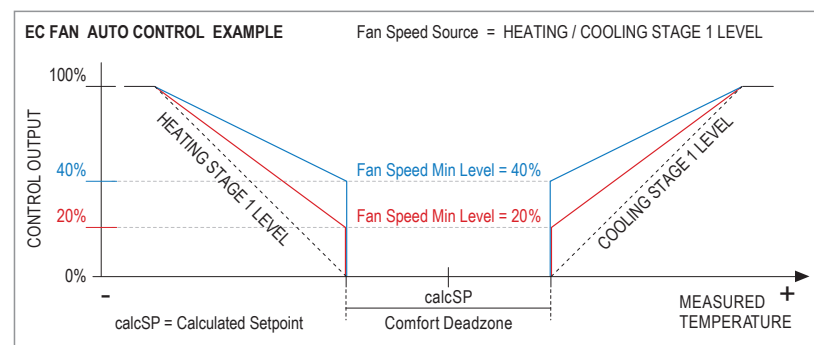

If the minimum fan speed is set to >0 %, fan consumption scales between minimum and maximum fan speed (100 %). To limit the maximum fan speed, scale the analogue output (Y1, Y2, Y3). By default, fan speed is assigned to analogue output Y1.

In **ECO mode**, blower control works according to the same principle as in comfort mode.

In **OFF mode**, the fan is switched off except if frost was detected. In that case, blower capacity is switched to 33 %.

Manual priority switching

Use the fan speed parameter to configure manual priority switching with up to 6 blower speeds: ON/OFF, 2 speeds, 3 speeds or 6 speeds (see fan icons).

If released, users can tap the fan icon on the display to disable automatic control and to manually set the requested blower speeds. Tap repeatedly to navigate through the available options. If manual priority switching has been enabled, the colour line bar above the blower speed shows an "M".

In **ECO mode**, priority switching remains active.

In **OFF mode**, it is inactive.

NOTE: Manual priority switching sets the blower to the selected speed control, as described above.

The parameter **Min. Fan Level** is ignored in manual mode.

**ICONS
BLIND
LIGHT**

BLIND
(max. 2 zones)

TAP THE ICON TO
ENABLE MANUAL
SETTING ON THE
BLIND SCREEN

NOTE:
If 2 blinds zones are
released, the lights
cannot be controlled
manually.
Configuring 2 light zones
is not possible.

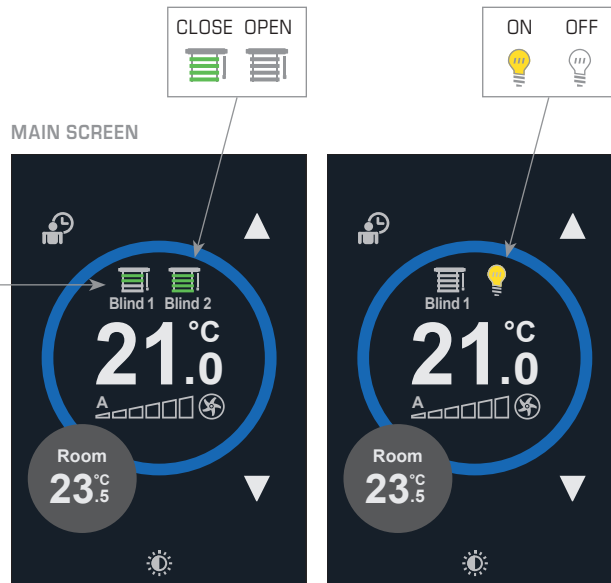

Fig. 8a Blind (2 zones)

Fig. 8b Light (1 zone)

**CONFIGURATION OF
LIGHTS MODE**



0 - 1	ON/OFF	(2 steps: 0 % / 100 %)
0 - 1 - 2	3 switching steps	(3 steps: 0 % / 50 % / 100 %)
0 - 1 - 2 - 3	4 switching steps	(4 steps: 0 % / 33 % / 66 % / 100 %)

**CONFIGURATION OF
LIGHTS OFF DELAY**

	Delay Time	Switch-off delay	(timer: 0...1800 s - default: 30 s)
--	-------------------	------------------	-------------------------------------

**CONFIGURATION OF
LIGHTS INTERLOCK**

Disabled	Disabled (default)	
Comfort	ECO/OFF → Comfort	Light intensity 100 % (ON)
	Komfort → ECO/OFF	Light intensity 0 % (OFF)
	In ECO, manual and bus priority switching remain active	
Comfort + ECO	ECO/OFF → Comfort	Light intensity 100 % (ON)
	Comfort → OFF	Light intensity 0 % (OFF)
	Comfort → ECO	Light intensity unchanged
	In ECO, manual and bus priority switching remain active	

**LIGHT
CONTROL**

Display and
settings
(1 zone)

To manually operate the room lighting, the Lights toggle icon is released in the settings on the **main screen** (FAN, BOOST, LIGHTS and BLINDS – Enable Function 2).

The output capacity of the lights control can be linked to any of the analogue outputs and/or is available as a bus variable.

Tap the toggle icon to manually change the **light intensity** (Lights Mode) in comfort, ECO and OFF mode in 2, 3 or 4 stages, depending on the configuration (see Table "Configuration of Light mode").

Additionally, you can configure a **lights switch-off delay** (Lights Delay Time). When the light is switched off, switch-off delay (regardless of the lights mode or the comfort, ECO and OFF operating modes) starts and the lights icon turns **red**. The **timer** can be configured in a range from 0 to 1800 s (default: 30 s).

BLIND CONTROL

Display and settings
 (2 zones)

Release toggle icons  on the **main screen** to operate the blinds zones (up to 2 zones). The toggle icons are released in the settings (FAN, BOOST, LIGHTS & BLINDS – Enable Function 1 / 2).

The output capacity of the blinds control can be linked to any of the analogue outputs and/or is available as a bus variable.

NOTE:

The functions Lights and Blinds are displayed in two **icon positions** on the main screen. If 2 blinds zones are released, the lights cannot be controlled manually.

Tap the relevant icon so that the unit displays the **Blind screen**.

Depending on the configuration in the settings menu, an adjustment of the blinds can be made on the Blind screen using the arrows with different increments and movement types. Increments and movement types can be configured as follows.

Blind mode (increments):

- 2 positions (On/Off)
 - 5 positions (4 increments)
 - 11 positions (10 increments)
 - Infinite / 1% increments
- The positions are distributed equally from 0 -100 %.

Blind configuration (movement type, graphical illustration):

- translatory movement "Level" (Fig.9a)
- rotary movement "Tilt" (Fig.9b)
- translatory + rotary movement "Level + Tilt" (Fig.9c)

BLIND SCREEN (display options)

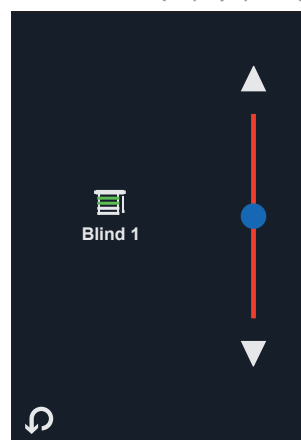

Fig. 9a 'Level'

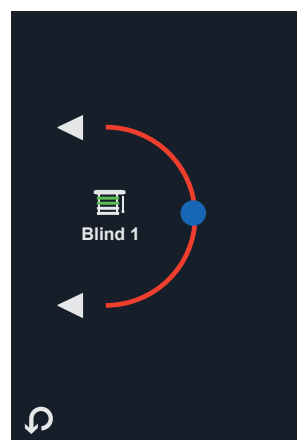

Fig. 9b 'Tilt'

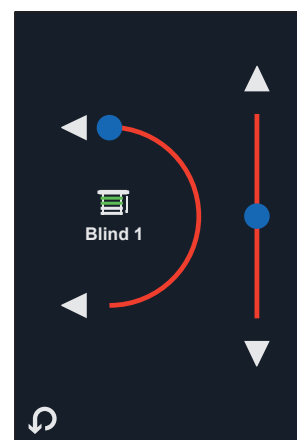

Fig. 9c 'Level + Tilt'

Briefly tap one of the arrows on the **Blind screen** to change the displayed value (0 -100 %) by the configured increment. Use the bus to retrieve and change the value (blinds position).

If **infinite increment** is set, the control responds to display actions as follows:

- Briefly tap the arrow to change the value by 1%.
- Tap an arrow for longer than 0.6 s to change the value automatically; then let go of the arrow. Automatic change stops by briefly tapping the arrow or when the minimum/maximum value (0% / 100%) is reached.

The valid command is always the latest one. That means that if the blinds position has been changed via the bus, the user can change the mode value again, and vice versa.

MODES FOR INPUTS RI1 AND RI2

can also be configured as digital inputs (DI)

(optionally as AI1 and AI2, 0...10V)

You can connect an external NTC10K sensor to the **RI1** and **RI2** inputs for various control and display tasks (optionally, **AI1** and **AI2** as analogue inputs 0...10V).

Use the parameters "Room Sensor Text", "Floor Sensor Text" and "Aux. Sensor Text" to release and adjust the display.

Use the parameters "RI1 Mode" and "RI2 Mode" to configure both channels. The following configuration options are available:

- **Disabled (default)**
- **Room (NTC10K)**
Enables main temperature control with a connected NTC10K sensor. The integrated temperature sensor is separate from the control. Use the parameter "Room Sensor Text" to release and adjust the display.
- **Floor (NTC10K)**
The input is used for limit value control (see chapter "Limit value control"). If RI1 and RI2 were both configured for a floor, RI1 is prioritised. Use the parameter "Floor Sensor Text" to release and adjust the display.
- **AUX control circuit (NTC10K)**
Releases the input for the auxiliary control circuit in a second zone (see chapter "AUX control circuit"). If RI1 and RI2 were both configured for outdoor temperature control, RI1 is prioritised. Use the parameter "Aux Sensor Text" to release and adjust the display.
- **Changeover (NTC10K, heating/cooling)**
The input is used to automatically switch into changeover mode (see chapter "Changeover"). The temperature value is not displayed.
- **Bus (NTC10K)**
The input is available for temperature recording using the connected NTC10K sensor via the bus (no control function). The temperature value is not displayed.
- **Bus [AI option, 0...10V]**
The 0...10 V input signal is converted to 0...100 % and can be queried via the bus.
- **CO2 (AI option, 0...10V)**
The 0...10 V input signal is converted into 0...2,000ppm. The measurement is available via the bus for monitoring purposes and automatically linked to the CO2 control (see chapter "CO2 control circuit"). The CO2 value is not displayed.
- **Main control circuit [AI option, 0...10V]**
The 0...10 V input signal is converted into 0...50 °C. The measurement is available via the bus for monitoring purposes and automatically linked to the temperature main control circuit. Use the parameter "Room Sensor Text" to release and adjust the display.
- **Close for ECO (DI mode)**
Voltage-free digital input for priority switching to ECO if closed.
- **Open for ECO (DI mode)**
Voltage-free digital input for priority switching to ECO if open.
- **Close for OFF (DI mode)**
Voltage-free digital input for priority switching to OFF if closed.
- **Open for OFF (DI mode)**
Voltage-free digital input for priority switching to OFF if open.
- **Condensation protection (DI mode)**
The input is used for a condensation resistance sensor to disable cooling if condensation is detected.
NOTE: If the input is used for condensation monitoring, do **not** set the digital input mode to "disable cooling" as the digital input configuration is prioritised.
- **Bus DI**
Voltage-free digital input to read from the bus.

NOTE: Resistance inputs used as digital inputs work with a **delay** of approx. 10 s and are not effective immediately. Therefore, they are **not** suitable for rapid switching as their effect only comes after an inherent delay.

DIGITAL INPUT DI1

The voltage-free digital input provides the following configuration options:

- **Close for ECO** (default)
- **Open for ECO**
- **Close for OFF**
- **Open for OFF**
- **Changeover**: Toggles stage 1 control between heating and cooling.
- **Disable cooling**: Disables the cooling stages if ON (condensation protection)
- **Contact alarm**
- **Bus**
- **Close for BOOST**
- **Open for BOOST**

Close for ECO / OFF

Link the voltage-free digital contact to an external timer, for example, to switch the controller into OFF mode while the timer is counting down. When the system switches from open (comfort mode) to closed (ECO-/OFF mode), the operating mode only changes after the timer has counted down.

Open for ECO / OFF

Use the voltage-free digital input to enable ECO or OFF mode when the contact opens. In this operating mode, it can be used to connect a window switch, door card switch or PIR sensor. When the system switches from closed to open, the operating mode changes only after the timer configured in the parameter "Digital Input Delay" has counted down.

Changeover

You can use the digital input for priority switching from heating to cooling mode (see chapter "Changeover"). The controller works in heating mode if the contact is open, and in cooling mode if the contact is closed.

Disable cooling (condensation protection)

When the digital input closes, the cooling control circuits are set to 0% to prevent condensation. In this mode, the digital input is normally connected to a condensation sensor.

NOTE: Configuring the digital input against condensation has priority over the operating mode of the resistance input against condensation (**RI1 and RI2**).

Contact alarm

When the digital input closes, the display shows a "DI contact alarm" message.

Bus

The digital input is used for monitoring purposes via the bus. No further effects on the unit control.

Close/open for BOOST

The digital input switches the controller into boost mode until it re-disables boost mode. When boost is enabled via the digital input, the display shows "Boost" instead of the target temperature.

NOTE: The parameter "Digital Input Delay" applies to all the configurations mentioned.

MODES FOR ANALOGUE OUTPUTS

The controller has **three** analogue outputs (0...10 V DC) and they are typically linked to the control circuit outputs.

The following configuration options are available:

- **Bus**
Operated as 0...10 V output variable for the bus
- **Heating stage 1 (Htg Stage 1)**
The 0...10 V output is linked to heating stage 1 (default: Y2)
- **Heating stage 2 (Htg Stage 2)**
The 0...10 V output is linked to heating stage 2
- **Cooling stage 1 (Clg Stage 1)**
The 0...10 V output is linked to cooling stage 1 (default: Y3)
- **Cooling stage 2 (Clg Stage 2)**
The 0...10 V output is linked to cooling stage 2
- **Fan (Modulating Fan)**
The 0...10 V output is linked to the fan control circuit output (default: Y1)
- **CO2 control (CO2)**
The 0...10 V output is linked to the CO2 control circuit outputs
(see chapter "CO2 control circuit")
- **Max. VAV (Max. Clg/CO2)**
The 0...10 V output is linked to the maximum capacity of the control circuits for cooling stage 1 and CO2
(see chapter "Fan speed control" and "CO2 control circuit")
- **Max. Fan (Max. Fan/CO2)**
The 0...10 V output is linked to the maximum capacity of the control circuits for CO2 and blower
(see chapter "CO2 control circuit")
- **Humidification**
The 0...10 V output is linked to the control circuit output for humidification
(see chapter "Humidity control circuit")
- **De-humidification**
The 0...10 V output is linked to the control circuit output for de-humidification
(see chapter "Humidity control circuit")
- **Light**
0...10 V linked to lighting stage
- **Blind 1 Level**
0...10 V linked to blind 1 position
- **Blind 1 Tilt**
0...10 V linked to the blind 1 slats' angle of inclination
- **Blind 2 Level**
0...10 V linked to blind 2 position
- **Blind 2 Tilt**
0...10 V linked to blind 2 slats' angle of inclination
- **Amber/red alarm**
0...10 V is at 50 % if the amber or the red alarm is active
- **Red alarm (Red)**
0...10 V is at 100 % if the red alarm is active
- **Heating stage 1 static (Htg Stage1 Stat)**
(see chapter "Relay output/ON-OFF")
- **Cooling stage 1 static (Clg Stage1 Stat)**
(see chapter "Relay output/ON-OFF")
- **Fan static (Fan Stat)**
(see chapter "Relay output/ON-OFF")
- **AUX control circuit (Aux. Loop)**
(see chapter "AUX control circuit")
- **6-way valve (6-Port)**
(see chapter "6-way valve control")
- **6-way valve inverse (6-Port Reverse)**
(see chapter "6-way valve control", inverse mode).

SCALE ANALOGUE OUTPUTS/ CAPACITY LIMIT

Each of the three analogue outputs (**Y1/Y2/Y3**) can be assigned a minimum and maximum output voltage (between 0...100 %) (default: min = 0 % / max = 100 %).

The capacity specification from the control circuit (0...100 %) is then scaled through the minimum output voltage to the maximum one.

Example:

To have the EC fan always work at the maximum speed, set the minimum output voltage to 10 % (1 V) and the maximum output voltage to 70 % (7 V).

In that case, the 0...100 % control circuit output (Control Loop) on the analogue output is scaled to 10...70 % . This helps to minimise blower noise and fan speed.

The values are available in connected systems for the bus master to write/read.

RELAY OUTPUTS BLOWER CONTROL

Typ 620 (0.5 A)

Typ 630(7A)

Typ 650 (0.5 A)

Typ 660 (7 A)

The unit types RYMASKON® 620/630/650/660 each have three relay outputs (**RLY1/2/3**) to be used for controlling three-speed blowers (one relay switches with time).

Relay 1 "ON": at approx. **30** % of blower consumption

Relay 2 "ON": at approx. **60** % of blower consumption

Relay 3 "ON": at approx. **90** % of blower consumption

The relays switch to "OFF" if the consumption is approx. 20 % below the respective switch-on value.

NOTE: To use the relay outputs to control the fans, the **operating mode** of the analogue output **Y1** must be set to "Fan" (default).

NOTE: **Types 620/650** have been designed for a maximum nominal resistive load of 0.5 A.
Types 630/660 have been designed for a maximum nominal resistive load of 7 A.

RELAY OUTPUT TEMPERATURE CONTROL OPEN / CLOSE

Typ 650 (0.5 A)

The RYMASKON® 650 unit type has a fourth 230 V AC relay (**RLY4**) to interconnect heating and cooling valves using 230 V AC "OPEN/CLOSE".

Ensure to set output **Y2** to one of the following configurations (see chapter "Analogue outputs modes"):

- **Htg Stage1 Stat**
If the **Y2** output capacity exceeds 10 %, **RLY4** switches heating stage 1.
If the **Y2** output capacity is 0 %, **RLY4** switches heating stage 1 back.
- **Clg Stage1 Stat**
If the **Y2** output capacity exceeds 10 %, **RLY4** switches cooling stage 1.
If the **Y2** output capacity is 0 %, **RLY4** switches cooling stage 1 back.
- **Fan Stat**
If the **Y2** output capacity exceeds 10 %, **RLY4** switches the fan.
If the **Y2** output capacity is 0 %, **RLY4** switches the fan back.

Type 650 also allows **Y1** to be configured for "Htg Stage1 Stat" or "Clg Stage1 Stat". In that case, relay 3 (**RLY3**) switches another open/close valve according to the description above. This allows the controller to be used for heating and for cooling control of open/close valves.

If this application requires an additional fan control, use an **EC fan**. It will be activated by the **Y3** analogue output (0...10 V, EC fan). Ensure to configure the **Y3** output to "Fan" (see chapter "Analogue output modes").

NOTE: **Type 650** has been designed for a maximum nominal resistive load of 0.5 A.

**PWM CONTROL
DIGITAL OUTPUTS**

Typ 640
Typ 660 (7A)

The RYMASKON® 640/660 unit types have two digital Triac outputs (digital outputs **DO1** and **DO2**). These digital outputs are used for **PWM** control of heating and cooling valves.

Use the parameter "PWM 1 Period" and/or "PWM 2 Period" to set the PWM duration. The following diagram illustrates the PWM control principle.

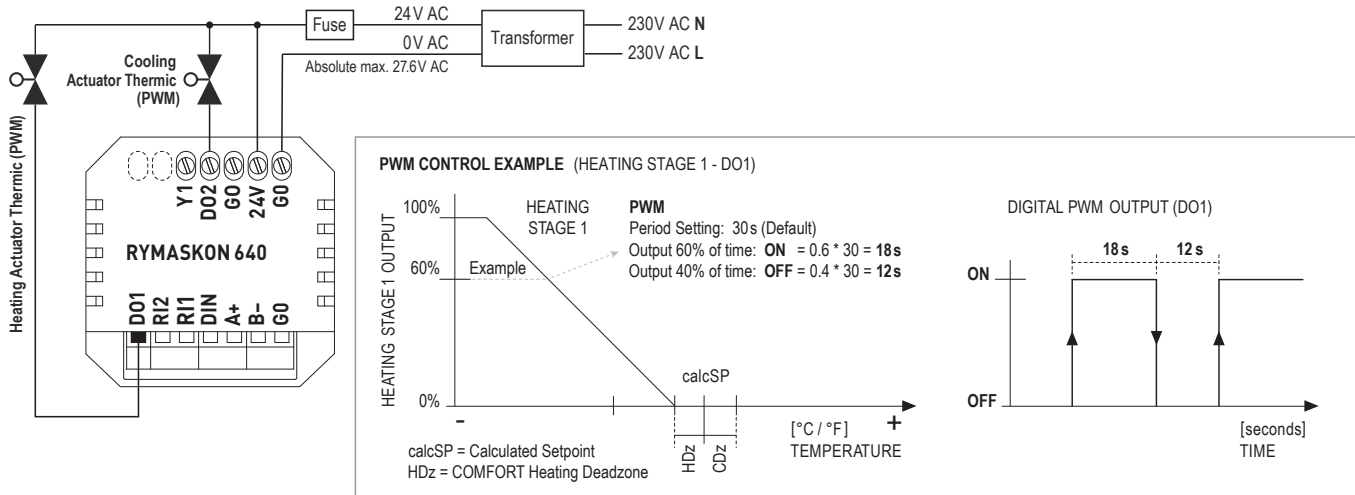

Typ 640 allows to operate an additional **EC fan** using the **Y1** analogue output (0...10V) or to use it for other valid output controls (see chapter "Analog output modes").

Typ 660 allows to operate a **3-speed fan** using the three relays (**RLY1/2/3**) (see chapter "Relay outputs/blower control").

In both cases, ensure to set the **operating mode** of the **Y1** analogue output to "EC fan" to control the fan (see chapter "Analogue output modes").

NOTE: Please note that **DO1** and **DO2** are 24VAC Triacs and switch to 0V (G0). Follow the circuit diagram above.

NOTE: **Typ 660** has been designed for a maximum nominal resistive load of 7A.

DO1 and **DO2** can be separately assigned to different control circuits (Thermic Mode), from where they draw their output capacity.

The following configuration options are available:

- **Bus value (Network Value)**
Output capacity is specified via the bus (Thermic Override Value)
- **Heating stage 1 (Htg Stage 1)**
Thermic output linked to heating stage 1
- **Heating stage 2 (Htg Stage 2)**
Thermic output linked to heating stage 2
- **Cooling stage 1 (Clg Stage 1)**
Thermic output linked to cooling stage 1
- **Cooling stage 2 (Clg Stage 2)**
Thermic output linked to cooling stage 2
- **CO2 Control**
Thermic output linked to CO2 control circuit (units with CO2 option)
- **Humidification**
Thermic output linked to control circuit for humidification (units with RH option)
- **De-humidification**
Thermic output linked to control circuit for de-humidification (units with RH option)
- **AUX control circuit (Aux Control Demand)**
Thermic output linked to AUX control circuit

NOTE: If PWM duration is set to "0", the output works in ON/OFF mode. The output switches "ON" at 10 % and "OFF" at 0 %.

6-WAY VALVE CONTROL

6-Port Control Mode

The **RYMASKON® 610** unit type (basic model) can also be used to control 6-way valves. To do so, configure the analogue output (**Y1/Y2/Y3**) for direct or inverse mode.

The following diagram illustrates the 6-way valve control principle.

NOTE: In direct or inverse 6-way mode, scaling the analogue output and/or the anti-JAM function are **not** available. Ensure to set the number of heating and cooling stages to at least "1".

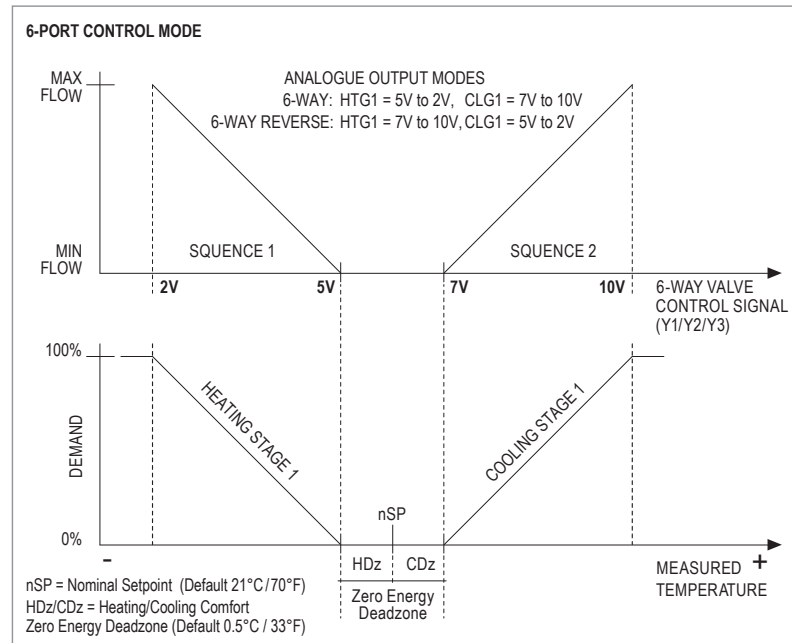

ANTI-JAM VALVE PROTECTION

AntiJAM Valve Exercise Function

If the **anti-JAM function** is released, the controller monitors the outputs for inactivity.

If the outputs were fully open or closed for longer than the set **anti-JAM time**, the controller will close and/or open them briefly by 30 %.

The anti-JAM time duration can be set from 0 to 14 days in the configuration parameters (Default: 0 = disabled).

ALARM INDICATOR
CO2, HUMIDITY,
TEMPERATURE

The controller provides **two alarm channels** to show if set limit values were exceeded/undercut. **Alarm sources** are internal temperature, humidity or CO2 sensors (for units with RH/CO2 option). For example, you can set "Alarm 1" to the CO2 concentration and "Alarm 2" to room air humidity. The default alarm function for the alarm source is "None", i.e., it is disabled.

Every alarm has three levels: **No alarm** (without icon), **amber alarm** 🚦 and **red alarm** 🔴. If an alarm is active, an amber or a red bell is shown in the small action circle on the display. The action circle consecutively shows all active measurements, i.e., the alarm is shown with its reading.

The following parameters can be separately configured for every alarm channel:

- Alarm Source
- Alarm Amber Threshold
- Alarm Red Threshold
- Alarm Hysteresis

Whether an alarm is triggered by exceeding or undercutting a limit value is automatically determined by the higher threshold of red or amber. The following descriptions illustrate this principle:

HIGH LIMIT ALARM

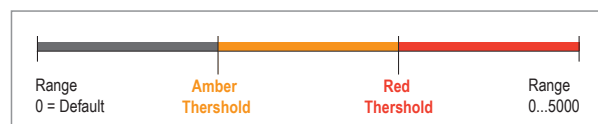

Alarm because of **exceeding** a limit value, if threshold **Red higher than amber** is set:

- Sensor value \leq threshold **amber** → no alarm (without icon)
- Sensor value \geq threshold **amber** → **alarm** indicated by amber bell
- Sensor value \geq threshold **red** → **alarm** indicated by red bell

Hysteresis prevents returning to a lower alarm level until the sensor value **goes down** to a threshold **minus** hysteresis.

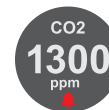
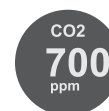

LOW LIMIT ALARM

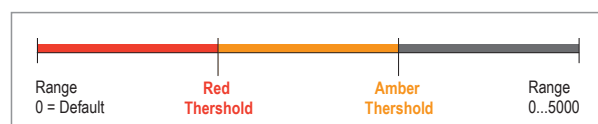

Alarm because of **undercutting** a limit value if threshold **Amber higher than red** is set:

- Sensor value \leq threshold **red** → **alarm** indicated by red bell
- Sensor value \leq threshold **amber** → **alarm** indicated by amber bell
- Sensor value \geq threshold **amber** → no alarm (without icon)

Hysteresis prevents returning to a lower alarm level until the sensor value **goes up** to a threshold **plus** hysteresis.

LANGUAGE SELECTION

Release of language selection (EN/DE/FR/ES/IT) to change the language on the main and sub screen

Different languages are available for the main and sub screen and can be set in the system configuration (Settings -> System -> Language).

The operator of the room control unit can also be authorised to change the user interface language. To this end, a toggle icon can be released in the settings as an acronym at the bottom left of the **main screen** for the active language (Settings -> System -> Show Language Swap) (Fig. 10a).

Tap the acronym to display the available languages, and the operator can directly change the language on the screen. (Fig. 10b)

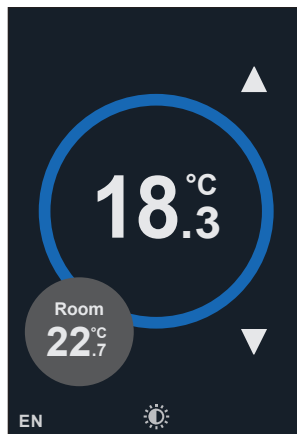
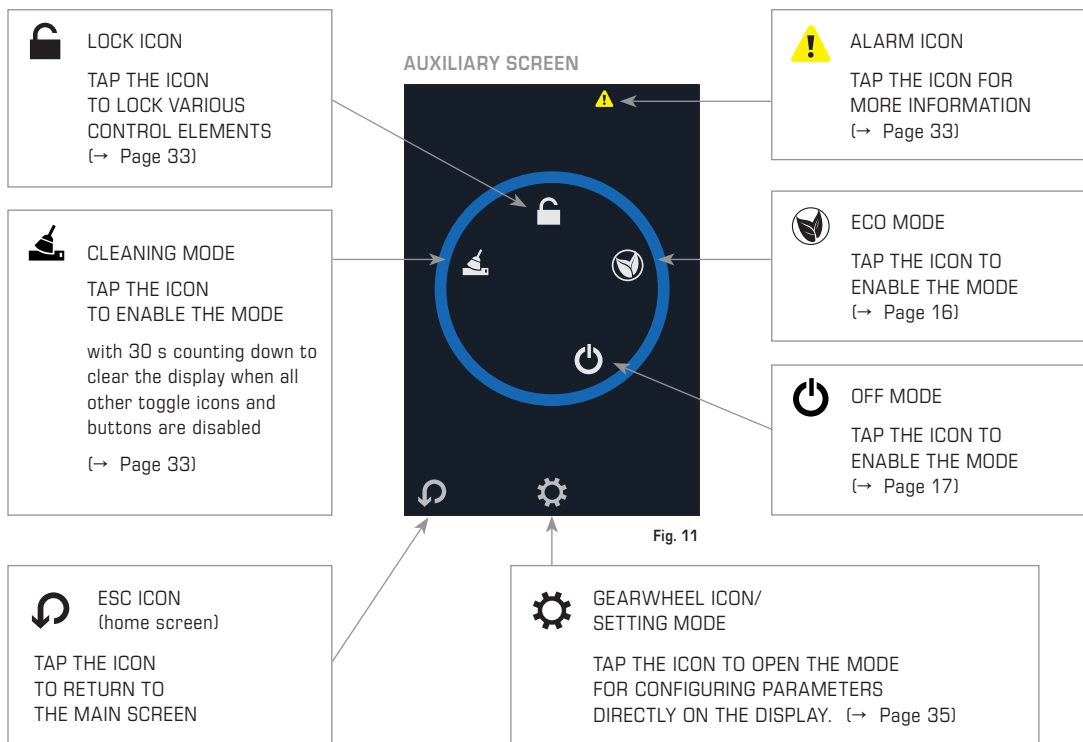

Fig. 10a Language acronym (tap to open the selection of the language options)



Fig. 10b Language options

AUXILIARY SCREEN ICONS



AUXILIARY SCREEN

Other operating icons and information

Access the **sub screen** by tapping the small grey action circle on the main screen.

If necessary, protect access to the sub screen using a **PIN** code ("Staff Code", default: 0000 = no PIN required).

The sub screen has several touch-sensitive areas to change the settings.

- **Alarm icon** to get warnings (error messages).
- **Cleaning icon** to enable cleaning mode (30 s timer).
- **Lock icon** to enable and detect locking mode (display lock); multiple access levels are available.
- **ECO icon** to enable ECO mode (extended dead zone); disable it via the main screen.
- **OFF icon** to enable OFF mode; disable it via the main screen.
- **Gearwheel icon** to open setting mode (see "Parameter configuration").

ALARM DISPLAY

Accessing the alarm notifications

Warnings on the unit can be accessed by tapping the Alarm icon on the **auxiliary screen**.

NOTE:

If 'Bus' is set as the sensor source, the alarm will be suppressed.

Typical causes of an alarm notification.

- **External sensor 1 (RI1) error**
(if activated but not connected)
- **External sensor 2 (RI2) error**
(if activated but not connected)
- **Integrated sensor error**
- **Digital contact error**

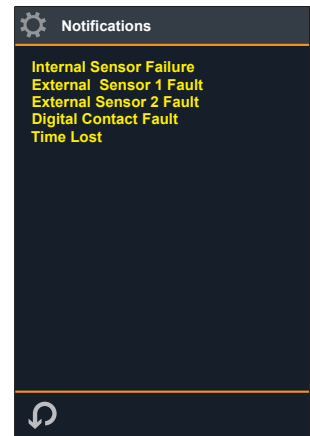

Fig. 12

CLEANING MODE

Activating Cleaning Mode (cleaning the display)

Cleaning mode can be activated by tapping the Cleaning icon on the **auxiliary screen**.

The unit changes to the 'display cleaning' state, all switching icons and buttons are disabled and a 30 second timer is displayed.

The display can be cleaned during this time without causing any unintentional entries.

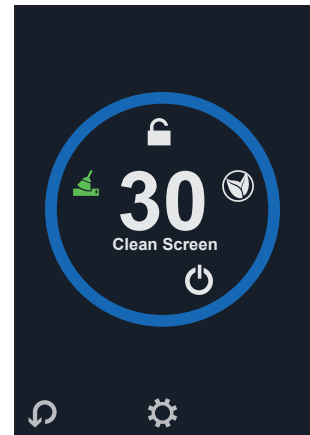

Fig. 13

LOCK MODE

Activate the display lock

Tapping the lock icon on the **auxiliary screen**, makes it possible to lock the unit to prevent unauthorized access.

A **PIN** code can be defined to activate/deactivate the locking state ('Lock Code', default: 0000 = no PIN required).

NOTE:

The display lock is also retained if the unit is switched off and back on again.

The following configurations are available (see table).

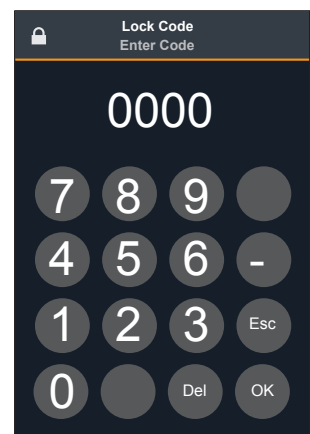



Fig. 14

LOCK MODE	ACTIVE SWITCHING ICONS						
	LOCK	UP/DOWN	BOOST/ OFF MODE	CLEANING// ECO MODE	FAN	LIGHT	BLIND
Deactivated	–	●	●	●	●	●	●
Only ON / OFF	●	–	●	–	–	●	●
Only adjustment	●	●	–	–	–	–	●
No input	●	–	–	–	–	–	●

CONTROLLER STATUS

Display of the current status information

Tapping the gearwheel icon  on the **auxiliary screen**, activates setting mode in order to get current status information from the **Controller**.

Access requires entry of a **PIN** code ('Maintenance Code', default: 6666).

NOTE:

The PIN code can be changed in the settings (System - Maintenance Code). Note the new PIN for security.

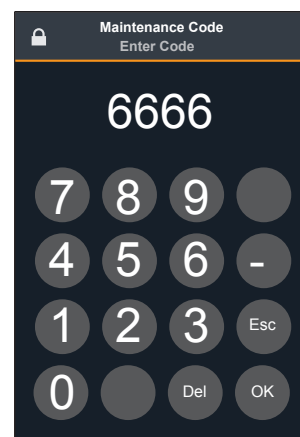

Fig. 15

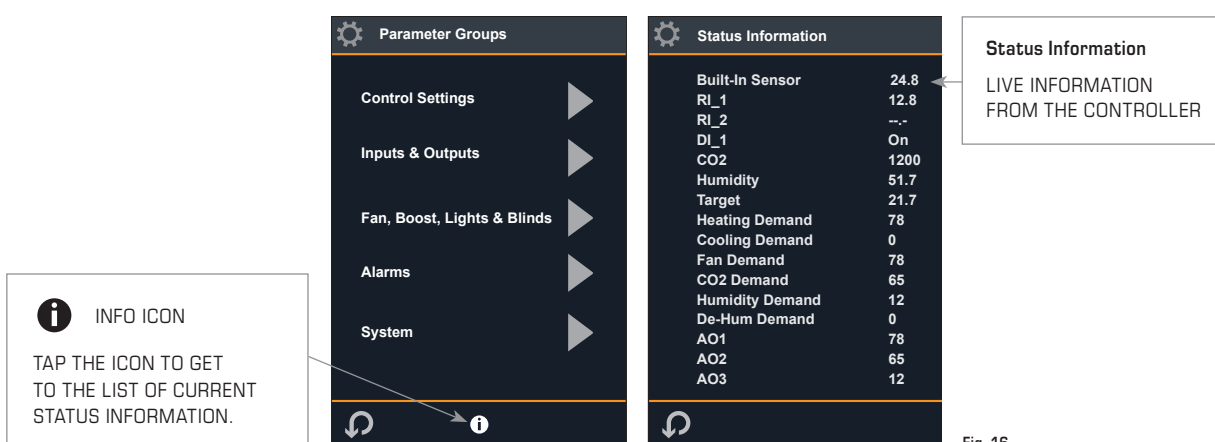



Fig. 16

After successfully entering the PIN code, the "Parameter Groups" are displayed. The info icon is located at the bottom of the display.

Tap the **Info icon**  to display detailed status information about the current state of controller readings and outputs.

CONFIGURING THE PARAMETERS

Setting Mode
 for changing parameters
 directly on the display

Tapping the gearwheel icon  on the **auxiliary screen** activates setting mode in order to configure accessible parameters directly on the display.

Access requires entry of a **PIN** code ('Maintenance Code', default: 6666).

NOTE:

The PIN code can be changed in the settings (System - Maintenance Code).
 Note the new PIN for security.

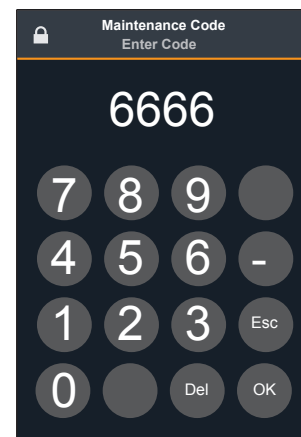

Fig. 17

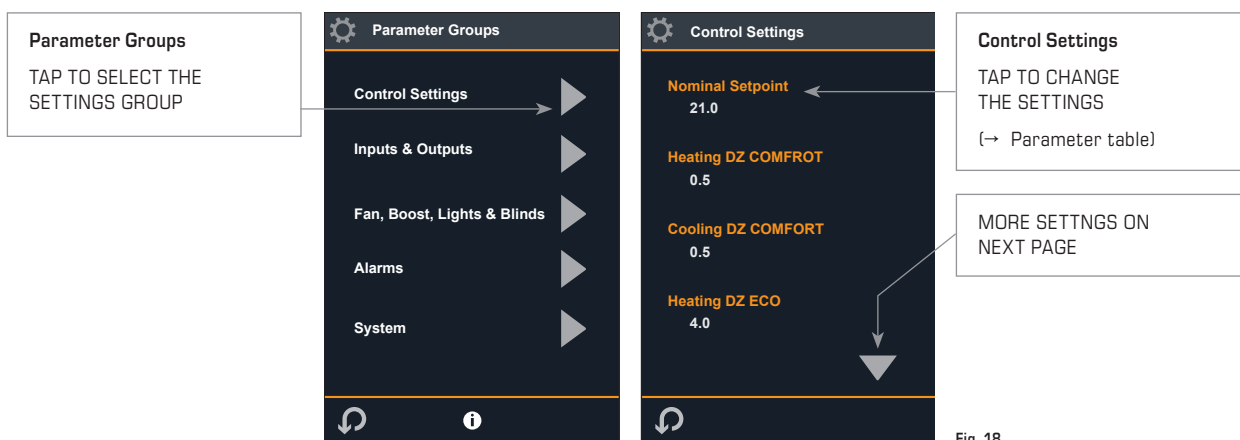

Fig. 18

After successfully entering the PIN Code, the 'Parameter Groups' **Parameter Groups** are displayed. Tapping the arrow key accesses the list of the subordinate **'Input Settings'**. The plain text here acts as a button for entry of the parameter settings. For description and input area, **see parameter table** on the following pages!

NOTE:

Changed communication parameters are activated when setting mode is exited – the unit performs a soft reset. Alternatively, the new settings can also be activated by switching the unit off and on again.

Saving the parameters

The configuration parameters are stored in the non-volatile memory of the unit. After changing the configuration via the display, the new parameters are saved when the unit returns to the main screen.

If the changes were made via the bus, the parameter for updating the non-volatile memory is required in order to force saving.

If configuration takes place via the display, the parameters are saved after an expiry time or when the settings menu is closed.

PARAMETER TABLE

Setting Mode via unit screen

CONTROL SETTINGS		
Parameter name	Description	Range
Nominal SP Nominal target temperature	Nominal target temperature NOTE: Use this parameter to change the target temperature via GLT. Using GLT to change the target temperature will set the user's manual adjustment to 0 (reset). Reset is done only if the new setpoint deviates from the original one. Writing the value may need to be done twice.	0.0...95.0°C/°F (default 21.0°C)
Heating DZ COMFORT Heating dead zone comfort	Heating mode dead zone in comfort mode (standard mode)	0.0...25.0°C/°F (default 0.5°C)
Cooling DZ COMFORT Cooling dead zone comfort	Cooling mode dead zone in comfort mode (standard mode)	0.0...25.0°C/°F (default 0.5°C)
Heating DZ ECO Heating dead zone ECO	Heating mode dead zone in ECO mode	0.0...25.0°C/°F (default 4.0°C)
Cooling DZ ECO Cooling dead zone ECO	Cooling mode dead zone in ECO mode	0.0...25.0°C/°F (default 4.0°C)
Frost SP Antifreeze target temperature	Temperature where the unit switches into antifreeze mode (antifreeze is enabled in OFF mode)	0.0...95.0°C/°F (default 8.0°C)
SP Adj. Max. Maximum setpoint	Maximum admissible upwards adjustment of the target temperature	0.0...20°C/°F (default 3.0)
SP Adj. Min. Minimum setpoint	Maximum admissible downwards adjustment of the target temperature	-20.0...0°C/°F (default -3.0)
PB	Proportional band of the temperature control circuit	1.0...50.0°C/°F (default 4.0)
IA	Integral reset time of the temperature control circuit 0 = Disabled	0...1.200s (default 600s)
Heating Stages Heating stages	Number of heating stages	0 = None 1 = 1 (default) 2 = 2
Heating Stage 1 Dir. Direction of heating stage 1	Control direction of heating stage 1	0 = Reverse (100...0%, default) 1 = Direct (0...100%)
Heating Stage 2 Dir. Direction of heating stage 2	Control direction of heating stage 2	0 = Reverse (100...0%, default) 1 = Direct (0...100%)
Cooling Stages Cooling stages	Number of cooling stages	0 = None 1 = 1 (default) 2 = 2
Cooling Stage 1 Dir. Direction of cooling stage 1	Control direction of cooling stage 1	0 = Reverse (100...0%) 1 = Direct (0...100%, default)
Cooling Stage 2 Dir. Direction of cooling stage 2	Control direction of cooling stage 2	0 = Reverse (100...0%) 1 = Direct (0...100%, default)
AUX SP Auxiliary target temperature	Target temperature for auxiliary control circuit (see chapter "AUX control circuit")	0.0...95.0°C/°F (default 21.0°C)
AUX PB	Proportional band for auxiliary control circuit (see chapter "AUX control circuit")	1.0... 50.0°C/°F (default 4.0)
AUX IA	Integral reset time for auxiliary control circuit, 0 = disabled (see chapter "AUX control circuit")	0...1.200s (default 600s)
AUX Dir. Auxiliary direction	Control direction of the auxiliary control circuit (see chapter "AUX control circuit")	0 = Reverse (100...0%) 1 = Direct (0...100%, default)
CO2 SP CO2 setpoint	Setpoint for CO2 control circuit, specified only via the bus (see chapter "CO2 control circuit")	0...5000ppm (default 1,000ppm)
CO2 PB	Proportional band for CO2 control circuit (see chapter "CO2 control circuit")	10...5000ppm (default = 300ppm)

CONTROL SETTINGS		
Parameter name	Description	Range
CO2 IA	Integral reset time for CO2 control circuit (see chapter "CO2 control circuit")	0...10.000 s (default 0 = disabled)
CO2 Dir. CO2 direction	Control direction for CO2 control circuit (see chapter "CO2 control circuit")	0 = Reverse (100...0%) 1 = Direct (0...100%, default)
Humidity SP Humidity setpoint	Setpoint for humidity control circuit (see chapter "Humidity control circuit")	0.0...100.0% RH (default 50%)
Humidity PB	Proportional band for humidity control circuit (see chapter "Humidity control circuit")	0.1...100.0% RH (default 20.0%)
Humidity IA	Integral reset time for humidity control circuit (see chapter "Humidity control circuit")	0..10.000 s (default 0 = disabled)
Humidification Dir. Humidification direction	Control direction for humidification (see chapter "Humidity control circuit")	0 = Reverse (100...0%) 1 = Direct (0...100%, default)
DeHum Dir. De-humidification direction	Control direction for de-humidification (see chapter "Humidity control circuit")	0 = Reverse (100...0%) 1 = Direct (0...100%, default)
Limit High Upper limit	Upper temperature limit in limit value standard mode (see chapter "Limit value control")	0.0...95.0°C/°F (default 35.0°C)
Limit Low Lower limit	Lower temperature limit in limit value standard mode (see chapter "Limit value control")	0.0...95.0°C/°F (default 16.0°C)
Limit Ratio Limit ratio	Limit ratio in limit value standard mode (see chapter "Limit value control")	0.0...5,0 (default 0.0 = disabled)
Changeover Low	Lower Limit in changeover mode where the unit automatically switches into cooling mode; cold water supply (see chapter "Changeover")	0.0...95.0°C/°F (default 20.0°C)
Changeover High	Upper limit in changeover mode where the unit automatically switches into heating mode; hot water supply (see chapter "Changeover")	0.0...95.0°C/°F (default 25.0°C)

INPUTS AND OUTPUTS		
Parameter name	Description	Range
Room Sensor Text	Designation of the temperature sensor in the main control circuit . Text and value are shown in the small action circle. If disabled, text and reading are hidden. (Default 1 = Room) NOTE: The room sensor and the main control circuit are assigned to the integrated temperature sensor by default. As an alternative, use "R11/R12 Mode" to define R11/R12 or A11/A12 as a room sensor and configure it as a control variable of the main control circuit.	0 = Disabled 1 = Room 2 = Floor 3 = Outside 4 = Zone 1 5 = Zone 2 6 = Zone 3 7 = Bathroom 8 = Sauna
Floor Sensor Text	Designation of the temperature sensor in the limit value control circuit . The value is shown in the small action circle. If disabled, text and reading are hidden. Default: 2 = Floor NOTE: Use "R11/R12 Mode" to assign R11/R12 to the level sensor and the limit value control circuit and to configure it as the control variable of the limit value control circuit.	9 = Bedroom 10 = Kitchen 11 = Cooler 12 = Flow 13 = Hot Water 14 = Boiler 15 = Pool 16 = Room
Aux. Sensor Text	Designation of the temperature sensor in the auxiliary control circuit . The value is shown in the small action circle. If disabled, text and reading are hidden. Default: 3 = Outside NOTE: Use "R11/R12 Mode" to assign the AUX sensor and the auxiliary control circuit to R11/R12 and configure it as the control variable of the auxiliary control circuit.	

INPUTS AND OUTPUTS		
Parameter name	Description	Range
Humidity Display	Release of the humidity display (for units with RH option) The value is shown in the small action circle.	0 = Disabled 1 = Enabled (Default)
CO2 Display	Release of the CO2 display (for units with CO2 option) The value is shown in the small action circle.	0 = Disabled (Default) 1 = Enabled
Aux. Loop Source Aux temperature control circuit source	Source of the temperature measurement for the auxiliary control circuit. (Display in the small action circle when recording a valid temperature value.)	0 = Built-In Sensor (Default) 1 = Network Temp
Digital Input Mode	Operating mode of the digital input (DI mode)	0 = Close for ECO (Default) 1 = Open for ECO 2 = Close for OFF 3 = Open for OFF 4 = Change-Over 5 = Disable Cooling 6 = DI Contact Alarm 7 = Network 8 = Close for Boost 9 = Open for Boost
Digital Input Delay	Delay time of the digital inputs (when switching from active to inactive)	0...28800s (default 0s)
RI1 mode	Operating mode of input RI1/AI1 (see chapter "Modes for inputs RI1 and RI2")	0 = Disabled (default) 1 = Room
RI2 Mode	Operating mode of input RI2/AI2 (see chapter "Modes for inputs RI1 and RI2")	2 = Floor 3 = Aux. Loop 4 = Heating/Cooling (heating/cooling, changeover) 5 = Network NTC10 (bus) 6 = Network 0–10V (bus) 7 = CO2 8 = Main Loop (main control circuit) 9 = Close for ECO (DI-mode) 10 = Open for ECO (DI-mode) 11 = Close for OFF (DI-mode) 12 = Open for OFF (DI-mode) 13 = Condensation (condensation protection) 14 = Network DI (Bus DI)
Internal Sensor Cal. Integrated sensor calibration	1-point compensation for integrated temperature sensor	-10.0...+10.0°C/°F
RI1 Cal. RI1 calibration	1-point compensation for temperature sensor on RI1 (NTC10K)	-10.0...+10.0°C/°F
RI2 Cal. RI2 calibration	1-point compensation for temperature sensor on RI2 (NTC10K)	-10.0...+10.0°C/°F
CO2 Cal. CO2 calibration	1-point compensation of the integrated CO2 sensor (Units with CO2 option)	-500...+500ppm
Humidity Cal. Humidity calibration	1-point compensation of the humidity sensor (Units with RH option)	-10.0...+10.0% RH

INPUTS AND OUTPUTS		
Parameter name	Description	Range
Y1	<p>Assignment of output capacity from control circuits (0...100%) to the analogue output Y1 (0...10V). Default 5 = Modulating Fan (fan)</p> <p>see the following chapter:</p> <ul style="list-style-type: none"> • Analogue output modes • Blower control relay outputs • Temperature control relay output OPEN/CLOSE <p>NOTE: The RYMASKON types 620, 630, 650 and 660 have relay outputs to control 3-speed blowers (instead of 0...10V outputs). Leave Y1 at Modulating Fan (default).</p>	0 = Network 1 = Htg Stage 1 2 = Htg Stage 2 3 = Clg Stage 1 4 = Clg Stage 2 5 = Modulating Fan 6 = CO2 7 = Max. VAV (Max. Clg/CO2) 8 = Max. Fan (Max. Fan/CO2) 9 = Humidification 10 = De-Humidification 11 = Lights 12 = Blind 1 Level 13 = Blind 1 Tilt 14 = Blind 2 Level 15 = Blind 2 Tilt 16 = Amber/Red 17 = Red 18 = Htg Stage1 Stat 19 = Clg Stage1 Stat 20 = Fan Stat 21 = Aux. Loop 22 = 6-Port 23 = 6-Port Reverse
Y2	<p>Assignment of output capacity from control circuits (0...100%) to the analogue output Y2 (0...10V). Default 1 = Htg Stage 1 (heating stage 1) (RYMASKON 650: Default 15 = Htg Stage1 Stat)</p> <p>see the following chapter:</p> <ul style="list-style-type: none"> • Analogue output modes • Blower control relay outputs • Temperature control relay output OPEN/CLOSE <p>NOTE: Y2 is not available for RYMASKON types 640 and 660. These types require the Thermic 1/2 Mode to be configured.</p>	
Y3	<p>Assignment of output capacity from control circuits (0...100%) to the analogue output Y3 (0...10V). Default 3 = Clg Stage 1 (cooling stage 1)</p> <p>see the following chapter:</p> <ul style="list-style-type: none"> • Analogue output modes • Blower control relay outputs • Temperature control relay output OPEN/CLOSE <p>NOTE: Y3 is not available for RYMASKON types 640 and 660. These types require the Thermic 1/2 Mode to be configured.</p>	
Y1 Min.	Minimum value for Y1 output capacity	0...100% (default 0%)
Y1 Max.	Maximum value for Y1 output capacity	0...100% (default 100%)
Y2 Min.	Minimum value for Y2 output capacity	0...100% (default 0%)
Y2 Max.	Maximum value for Y2 output capacity	0...100% (default 100%)
Y3 Min.	Minimum value for Y3 output capacity	0...100% (default 0%)
Y3 Max.	Maximum value for Y3 output capacity	0...100% (default 100%)
Anti-JAM Valve protection	If the heating/cooling valves are not activated during the configured time, the unit will activate them briefly to prevent jamming.	0...14 days (default 0 = disabled)
PWM1 Period PWM1 duration	Only for RYMASKON 640/660 types PWM duration for digital output DO1 to activate the heating and cooling valves (see chapter "PWM control/digital outputs")	0...120 s (Default 30s) 0 = On/Off Control
PWM2 Period PWM2 duration	Only for RYMASKON 640/660 types PWM duration for digital output DO2 to activate the heating and cooling valves (see chapter "PWM control/digital outputs")	0...120 s (Default 30s) 0 = On/Off Control

INPUTS AND OUTPUTS		
Parameter name	Description	Range
Thermic 1 Mode	Only for RYMASKON 640/660 types Assignment of digital output DO1 to the control circuit Default 1 = Htg Stage 1 If set to Network, the GLT will control DO1. (see Section "PWM control/digital outputs")	0 = Network Value 1 = Htg Stage 1 2 = Htg Stage 2 3 = Clg Stage 1 4 = Clg Stage 2
Thermic 2 Mode	Only for RYMASKON 640/660 types Assignment of digital output DO2 to the control circuit Default 3 = cooling stage 1 If set to Network, the GLT will control DO1. (see Section "PWM control/digital outputs")	5 = CO2 Control 6 = Humidification 7 = De-humidification 8 = Aux Control Demand

FAN, BOOST, LIGHTS AND BLINDS		
Parameter name	Description	Range
Fan Speed Display	Display and fan speed and release of manual adjustment on the main screen (see chapter "Fan") NOTE: 2 to 5 will release the display on the main screen for manual adjustments.	0 = None (Default) 1 = No Input (no user adj.) 2 = 0 - 1 3 = 0 - 1 - 2 4 = 0 - 1 - 2 - 3 5 = 0 - 1 - 2 - 3 - 4 - 5 - 6
Fan Speed Source	Assignment of fan speed to the control circuit in AUTO Control. Fan speed depends on the selected control circuit. NOTE: Use the "Min Fan Level" parameter to configure the fan's minimum speed. Use the "Y Max" parameter to configure the fan's maximum speed. (see chapter "Fan")	0 = Htg/Clg Stage 1 (Default) 1 = Htg Stage1 2 = Clg Stage 1 3 = Htg/Clg Stage 2 4 = Htg Stage 2 5 = Clg Stage 2 6 = CO2 7 = Humidification 8 = De-Humidification 9 = Max. VAV (Max. Temp/CO2) 10 = Max. Temp/Hum 11 = Aux. Loop
Min Fan Level	Minimum fan speed in the dead zone (heating/cooling capacity 0%) with active fan switch-off delay (see chapter "Fan")	0...100% (default 0%)
Fan Off Delay	Blower switch-off delay if the consumption of the assigned control circuit is smaller than the minimum fan speed. (see chapter "Fan") NOTE: Only active if the minimum fan speed is configured to be greater than 0%.	0...28,800s (default 0s)
Boost Time	Boost mode runtime NOTE: If configured for 0, then the boost will not switch off automatically.	1...480 min (default 0)
Boost Target	Connects the boost to the control circuit and releases the control on the main screen.	0 = Disabled 1 = Htg Stage 1 (default) 2 = Htg Stages 1&2 3 = Clg Stage 1 4 = Clg Stages 1&2 5 = Humidification 6 = De-Humidification 7 = CO2 8 = Fan 9 = Aux. Loop

FAN, BOOST, LIGHTS AND BLINDS		
Parameter name	Description	Range
Enable Function 1	Releases the icon for blind 1. NOTE: If blind 1 has been selected, Blind 1 Mode must be adjusted/checked at the same time.	0 = Disabled (Default) 1 = Blind 1
Enable Function 2	Releases the icon for lights or blind 2. NOTE: If blind 2 has been selected, Blind 2 Mode must be adjusted/checked at the same time.	0 = Disabled (default) 1 = Lights 2 = Blind 2
Blind 1 Mode	Sets the blind 1 increments when actuating the arrow keys on the screen. (1) On/Off: 0, 100% (2) 4 steps: 0, 25, 50, 75, 100% (3) 10 steps: 0, 10, 20, ..., 100% (4) infinite: 0, 1, 2, 3, ..., 100% Parameter 4 enables an automatic function automatically modifying the value if the key is pressed for a long time. (see chapter "Blind control")	1 = On / Off 2 = 4 steps 3 = 10 steps 4 = Infinite
Blind 1 Configuration	Releases the graphical display of the movement type of blind 2 and the relevant variables for manual control. (0) Level: translatory movement, UP/DOWN (1) Tilt: rotating movement, rotation (2) Level + Tilt (see chapter "Blind control")	0 = Level 1 = Tilt 2 = Level + Tilt
Blind 2 Mode	Sets the blind 1 increments when actuating the arrow keys on the screen. (1) On/Off: 0, 100% (2) 4 steps: 0, 25, 50, 75, 100% (3) 10 steps: 0, 10, 20, ..., 100% (4) infinite: 0, 1, 2, 3, ..., 100% Parameter 4 enables an automatic function automatically modifying the value if the key is pressed for a long time. (see chapter "Blind control")	1 = On / Off 2 = 4 steps 3 = 10 steps 4 = Infinite
Blind 2 Configuration	Releases the graphical display of the movement type of blind 2 and the relevant variables for manual control. (0) Level: translatory movement, UP/DOWN (1) Tilt: rotating movement, rotation (2) Level + tilt (see chapter "Blind control")	0 = Level 1 = Tilt 2 = Level + Tilt
Light Mode	Sets the light intensity increments when actuating the lights icon on the main screen. (1) 0-1: 0, 100% (2) 0-1-2: 0, 50, 100% (3) 0-1-2-3: 0, 33, 66, 100%	1 = 0-1 (default) 2 = 0-1-2 3 = 0-1-2-3
Light Off Delay	Delay for switching off the lighting	0...1.800s (default 30s)

FAN, BOOST, LIGHTS AND BLINDS		
Parameter name	Description	Range
Light Interlock	<p>Locks the lighting</p> <p>(1) Disabled Light intensity is maintained when toggling between comfort (standard mode) and ECO/OFF</p> <p>(2) Comfort</p> <ul style="list-style-type: none"> • ECO/OFF → Comfort (standard mode): Light intensity 100% • Comfort (standard mode) → ECO/OFF: Light intensity 0% • Priority switching by hand or via the bus; maintained in ECO/OFF mode <p>(3) Comfort + ECO</p> <ul style="list-style-type: none"> • ECO/OFF → Comfort (standard mode): Light intensity 100% • Comfort (standard mode) → OFF: Light intensity 0% • Comfort (standard mode) → ECO: Light intensity remains unchanged • Priority switching by hand or via the bus; maintained in ECO/OFF mode <p>(see chapter "Blind and Light icons")</p>	<p>0 = Disabled (Default)</p> <p>1 = Comfort</p> <p>2 = Comfort + ECO</p>

ALARMS		
Parameter name	Description	Range
Alarm 1 Source	Source for alarm indicator, alarm 1	<p>0 = CO2 sensor</p> <p>1 = Room (Temperature)</p> <p>2 = Humidity</p> <p>3 = None (Default)</p>
Alarm 1 Amber Threshold	Switching point for amber alarm indicator, alarm 1	0...5000 (default 0)
Alarm 1 Red Threshold	Switching point for red alarm indicator, alarm 1	0...5000 (default 0)
Alarm 1 Hysteresis	Hysteresis for alarm 1	0...5000 (default 0)
Alarm 2 Source	Source for alarm indicator, alarm 1	<p>0 = CO2 sensor</p> <p>1 = Room (Temperature)</p> <p>2 = Humidity</p> <p>3 = None (Default)</p>
Alarm 2 Amber Threshold	Switching point for amber alarm indicator, alarm 1	0...5000 (Default 0)
Alarm 2 Red Threshold	Switching point for red alarm indicator, alarm 1	0...5000 (Default 0)
Alarm 2 Hysteresis	Hysteresis for alarm 2	0...5000 (Default 0)

SYSTEM		
Parameter name	Description	Range
Address	Configuring the bus address	<p>Modbus: 0...247 (Default 1)</p> <p>BACNet: 0...127 (Default 1)</p>
Baud rate	Baud rate for Modbus or BACnet units	<p>0 = 9600 (Default)</p> <p>1 = 19200</p> <p>2 = 38400</p> <p>3 = 57600</p> <p>4 = 76800</p>
Parity	Parity for Modbus or BACnet units	<p>0 = None (Default)</p> <p>1 = Odd</p> <p>2 = Even</p>
Stop Bits	Stop bits for Modbus or BACnet units	<p>0 = 1 Stop Bit (Default)</p> <p>1 = 2 Stop Bits</p>

SYSTEM		
Parameter name	Description	Range
Device ID (Only BACnet Typs)	Unit ID (only for BACnet units)	0...4.194.303 (Default Auto = 651.001)
Service Pin (Only BACnet Typs)	BACnet Service-Pin. If enabled, the unit sends a BACnet "I-am" message.	0 = Disabled (Default) 1 = Enabled
Brightness Light intensity	Display lighting in standby	0...20 (Default 5)
Show Unit Swap Unit toggle display (°C/°F)	Releases the icon to toggle between degrees Celsius and degrees Fahrenheit on the main screen.	0 = Disabled (Default) 1 = Enabled
Lock Mode	Releases the lock icon to lock the display. Select the functions to be locked on the display (display lock): (0) Disabled: Icon for hidden/inactive display lock (1) On/Off Only: Display lock icon displayed/active, temperature/fan adjustment not possible, clearing and ECO icon disabled (2) Adjust Only: Display lock icon displayed/active, only temperature and blinds adjustment possible (3) No Input: Display lock icon displayed/active, only blinds adjustment possible	0 = Disabled (Default) 1 = On / Off Only 2 = Adjust Only 3 = No Input
Lock Code	PIN for enabling/disabling the display lock (0000: no PIN required)	0000...9999 (default 0000)
Maintenance Code	PIN for setting mode (0000 requires no PIN)	0000...9999 (default 6666)
Staff Code	PIN to access secondary screen (0000: no PIN required)	0000...9999 (default 0000)
Screen Refresh-Rate Display Refresh-Rate	Refresh rate of the LCD touch screen	0 = Fast (default) 1 = Medium 2 = Slow
Screen Cycle Speed Display cycle action circle	Toggle the readings shown in the small circle on the display Fast = 4.3s / medium = 7.8s / slow = 10.8s	0 = Fast 1 = Medium (default) 2 = Slow
Native units (defaults) °C/°F default	Default value of the temperature display in degrees Celsius or degrees Fahrenheit NOTE: Changes result in reloading the default values.	C = Celsius (default) F = Fahrenheit
Language User interface language	Available languages for the user interface (main screen)	0 = DE (Default) 1 = EN 2 = FR 3 = ES 4 = IT
Show Language Swap Toggle icon for language selection	Displays the toggle icon (language acronym) to select the user interface language on the main screen	0 = Disabled (Default) 1 = Enabled
Reload Default Preferences	Reload factory settings (defaults)	0 = Off (default) 1 = On
Version	Software version	x.xx (BACnet/Modbus)



© Copyright by S+S Regeltechnik GmbH

Reprint in full or in parts requires permission from S+S Regeltechnik GmbH.

Subject to errors and technical changes. All statements and data herein represent our best knowledge at date of publication. They are only meant to inform about our products and their application potential, but do not imply any warranty as to certain product characteristics. Since the devices are used under a wide range of different conditions and loads beyond our control, their particular suitability must be verified by each customer and/or end user themselves. Existing property rights must be observed. We warrant the faultless quality of our products as stated in our General Terms and Conditions.

