

# UTC2SC3835

# NPN EPITAXIAL SILICON TRANSISTOR

## SWITCH NPN TRANSISTOR

### APPLICATION

\*Humidifier,DC-DC converter,and general purpose.

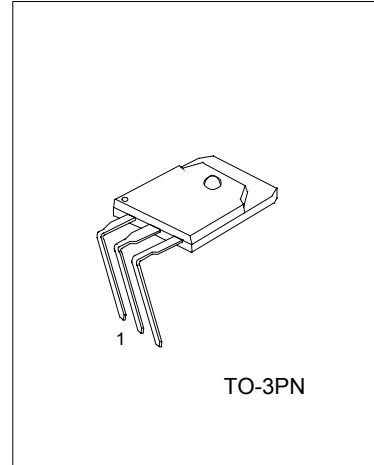

1: BASE 2:COLLECTOR 3: EMITTER

### ABSOLUTE MAXIMUM RATINGS (Ta=25°C)

| PARAMETER                              | SYMBOL           | RATING     | UNIT |
|--|------------------|------------|------|
| Collector-Base Voltage                 | V <sub>CB0</sub> | 200        | V    |
| Collector-Emitter Voltage              | V <sub>CEO</sub> | 120        | V    |
| Emitter-Base Voltage                   | V <sub>EB0</sub> | 8          | V    |
| Base Current                           | I <sub>B</sub>   | 3          | A    |
| Collector Current                      | I <sub>c</sub>   | 7          | A    |
| Collector Current (PULSE)              |                  | 14         | A    |
| Collector Power Dissipation( Tc=25°C ) | P <sub>c</sub>   | 70         | W    |
| Junction Temperature                   | T <sub>j</sub>   | 150        | °C   |
| Storage Temperature                    | T <sub>STG</sub> | -55 ~ +150 | °C   |

### ELECTRICAL CHARACTERISTICS (Ta=25°C,unless otherwise specified)

| PARAMETER                            | SYMBOL               | TEST CONDITIONS                                     | MIN | TYP | MAX | UNIT |
|--------------------------------------|----------------------|---|-----|-----|-----|------|
| Collector Emitter Breakdown Voltage  | BV <sub>CEO</sub>    | I <sub>c</sub> = 50mA                               | 120 |     |     | V    |
| Collector Cut-Off Current            | I <sub>CB0</sub>     | V <sub>CB</sub> =200V, I <sub>E</sub> =0            |     |     | 100 | μA   |
| Emitter Cut-Off Current              | I <sub>EB0</sub>     | V <sub>EB</sub> = 8V, I <sub>c</sub> =0             |     |     | 100 | μA   |
| DC Current Transfer Ratio            | h <sub>FE</sub>      | V <sub>CE</sub> = 4V, I <sub>c</sub> = 3A           | 70  |     | 220 |      |
| Collector-Emitter Saturation Voltage | V <sub>CE(sat)</sub> | I <sub>c</sub> =3A ,I <sub>B</sub> =0.3A            |     |     | 0.5 | V    |
| Base-Emitter Saturation Voltage      | V <sub>BE(sat)</sub> | I <sub>c</sub> =3A ,I <sub>B</sub> =0.3A            |     |     | 1.2 | V    |
| Transition Frequency                 | f <sub>r</sub>       | V <sub>CE</sub> =12V, I <sub>E</sub> =-0.5mA        |     | 30  |     | MHz  |
| Output Capacitance                   | C <sub>ob</sub>      | V <sub>CB</sub> = 10V, I <sub>E</sub> = 0 A, f=1MHz |     | 110 |     | pF   |
| Turn-on Time                         | t <sub>on</sub>      | See specified Test Circuit                          |     |     | 0.5 | μs   |
| Storage Time                         | t <sub>stg</sub>     |   |     |     | 3.0 | μs   |
| Fall Time                            | t <sub>f</sub>       |   |     |     | 0.5 | μs   |

# UTC2SC3835 NPN EPITAXIAL SILICON TRANSISTOR

## CLASSIFICATION of hFE

| RANK  | A      | B       | C       |
|-------|--------|---------|---------|
| RANGE | 70-130 | 120-170 | 160-220 |

## Typical Switching Characteristics(Common Emitter)

| V <sub>CC</sub> (V) | R <sub>L</sub> (Ω) | I <sub>C</sub> (A) | V <sub>BB1</sub> (V) | V <sub>BB2</sub> (V) | I <sub>B1</sub> (A) | I <sub>B2</sub> (A) |
|---------------------|--------------------|--------------------|----------------------|----------------------|---------------------|---------------------|
| 50                  | 16.7               | 3                  | 10                   | -5                   | 0.3                 | -0.6                |

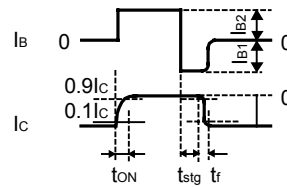
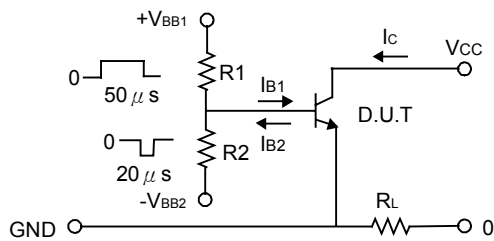

## ELECTRICAL CHARACTERISTICS CURVES

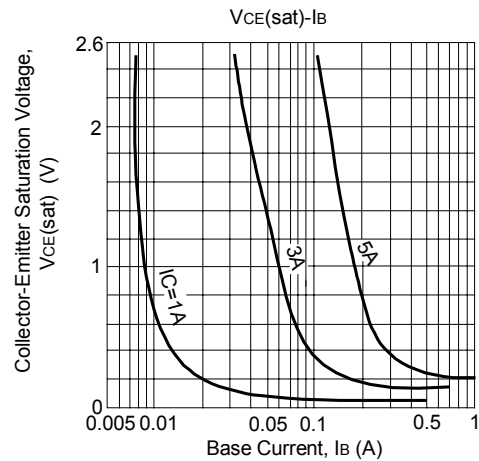
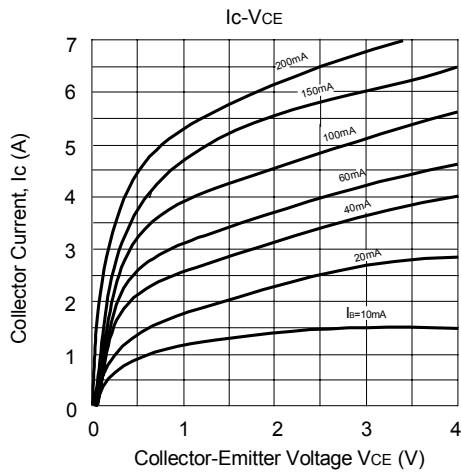

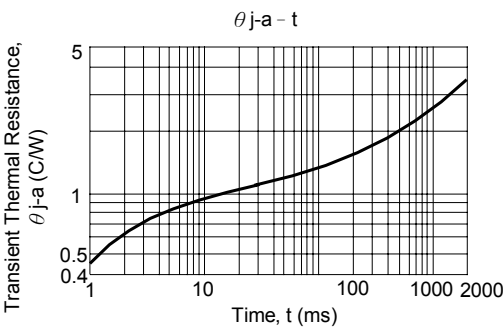
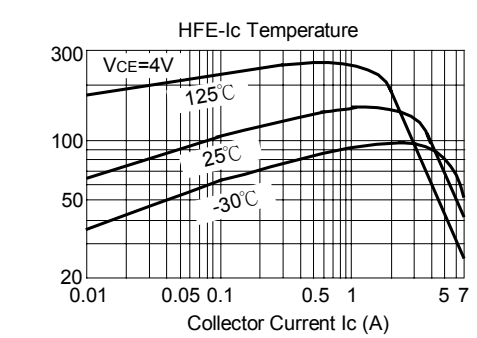
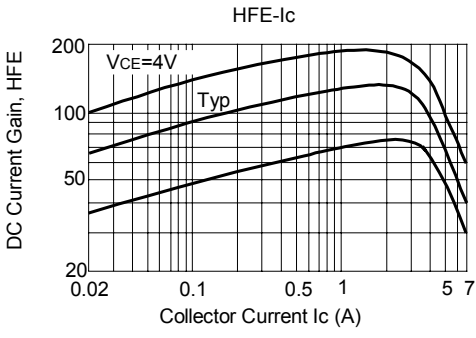
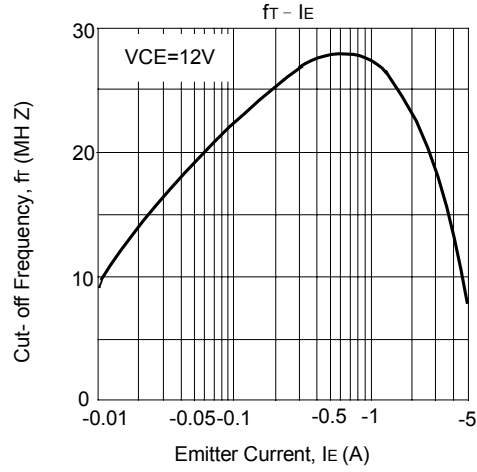
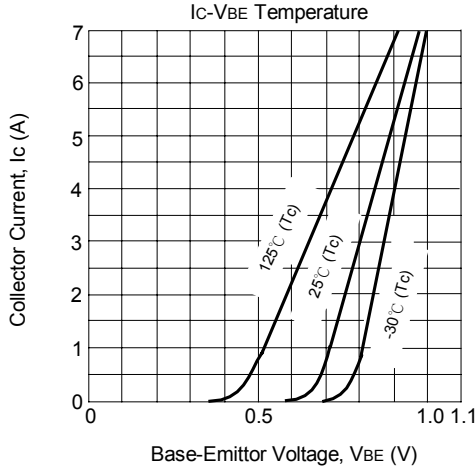

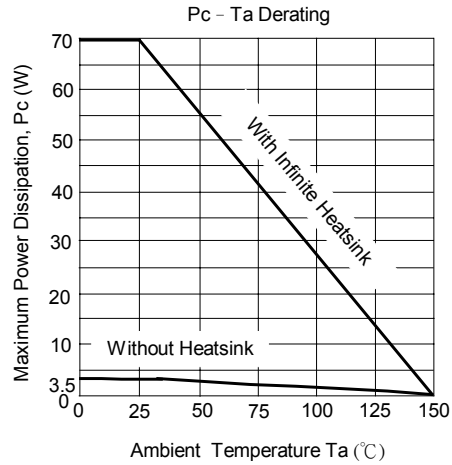
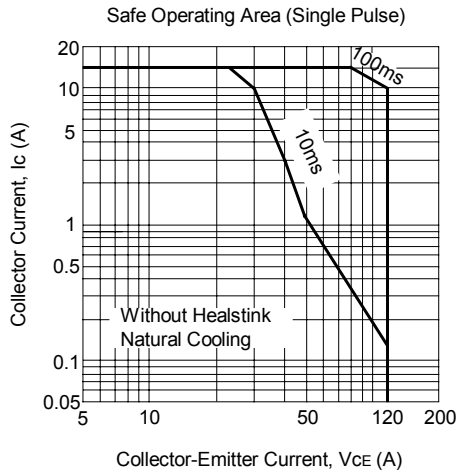

UTC assumes no responsibility for equipment failures that result from using products at values that exceed, even momentarily, rated values (such as maximum ratings, operating condition ranges, or other parameters) listed in products specifications of any and all UTC products described or contained herein. UTC products are not designed for use in life support appliances, devices or systems where malfunction of these products can be reasonably expected to result in personal injury. Reproduction in whole or in part is prohibited without the prior written consent of the copyright owner. The information presented in this document does not form part of any quotation or contract, is believed to be accurate and reliable and may be changed without notice.