

KORLOY High Pressure Coolant Holder

KHP

KORLOY
TECH-NEWS

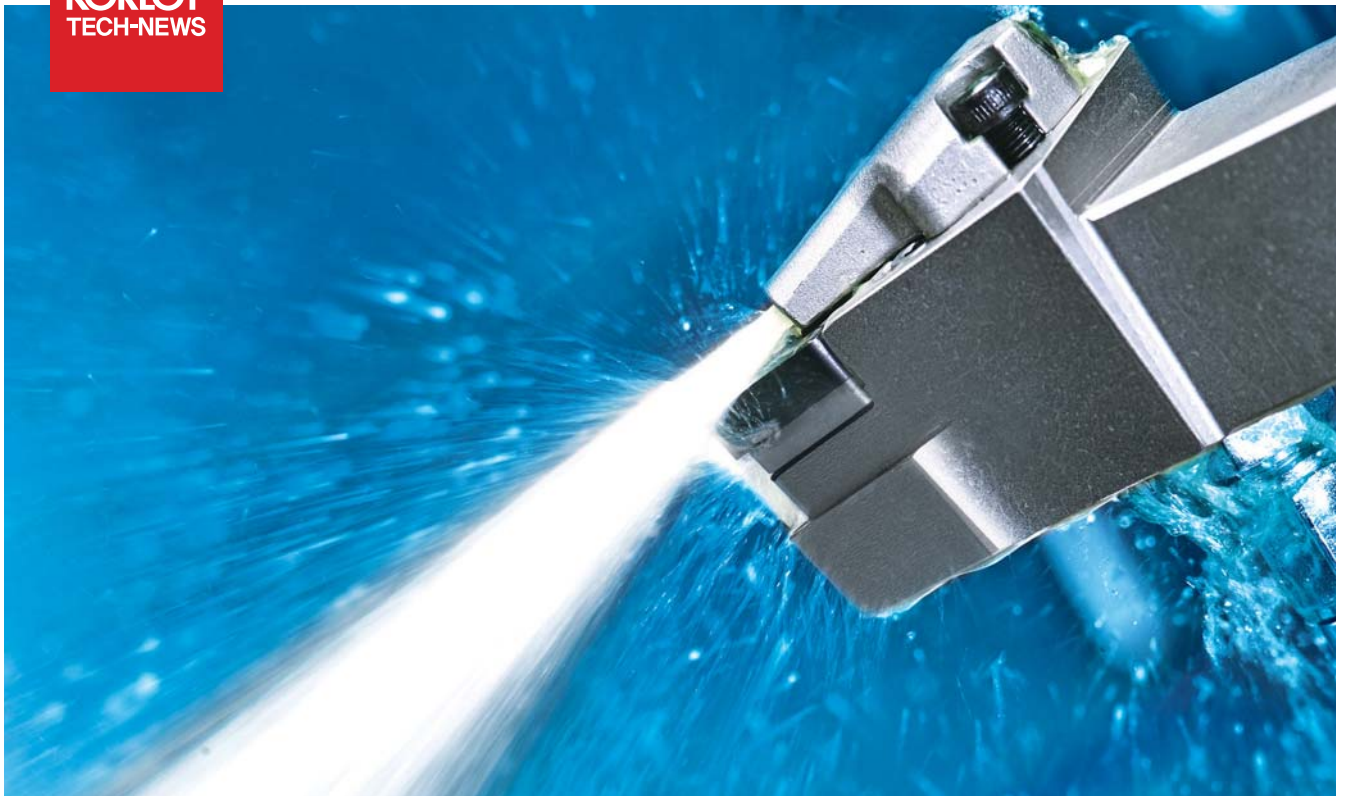

- 300% increased productivity on Inconel machining vs. low pressure coolant system
- Cooling, tool life, and chip control are improved by the high volume coolant multi-directional injection system

High Pressure Coolant Holder for Inconel Machining

KHP

The HRSA (Inconel, titanium and stainless steel) have high strength and low thermal conductivity used in the space, aircraft, and offshore machining industries, results in structure failures causes chipping on the cutting edge due to heat shock and work hardening and decreases tool life rapidly in machining.

The existing coolant spraying to wide parts is not able to reduce the focused heat on the cutting part in HRSA machining effectively. Therefore, to improve the productivity with high efficient cooling, a solution is needed. That is spraying the high pressure coolant directly on the cutting edge.

A high pressure coolant holder will have the optimal distance between the insert cutting edge and the jet

orifice, the ideal place of the streamlined jet orifice of the coolant. KORLOY's new KHP sprays high pressure coolant enhancing chip control and wear resistance.

Our KHP High pressure coolant holder's sliding clamp system provides easy change of inserts and optimal nozzle cooling.

KORLOY KHP High pressure coolant holder provides the best solution meeting the customers' needs with high productivity and highly precise machining, by reducing workpiece damage by limiting fracture of insert, and long chips, for heat removal in HRSA machining.



High productivity

- Tested up to 300% increased tool life comparing to machining with low pressure coolant system
- Increased cutting speeds and high feeds

Excellent coolant effect

- Direct spraying coolant on the edge of insert and on the top and bottom sides of insert

Improved chip control

- Better chip evacuation

Easy to clamp

- Sliding clamp system

Code System

P	C	L	N	R	25	25	-	M	12	-	KHP
Clamping method of insert P: Lever lock system	Holder style L: 95° J: 75°		Hand R: Right handed		Width of shank 25mm, 32mm			Length of insert cutting edge 08, 12, 15, 16			KORLOY High Pressure coolant
	Insert shape C: C type D: D type W: W type V: V type	Clearance angle of insert N: 0° B: 5°		Height of shank 25mm, 32mm		Length of holder M: 150mm P: 180mm					

Structure of Holder

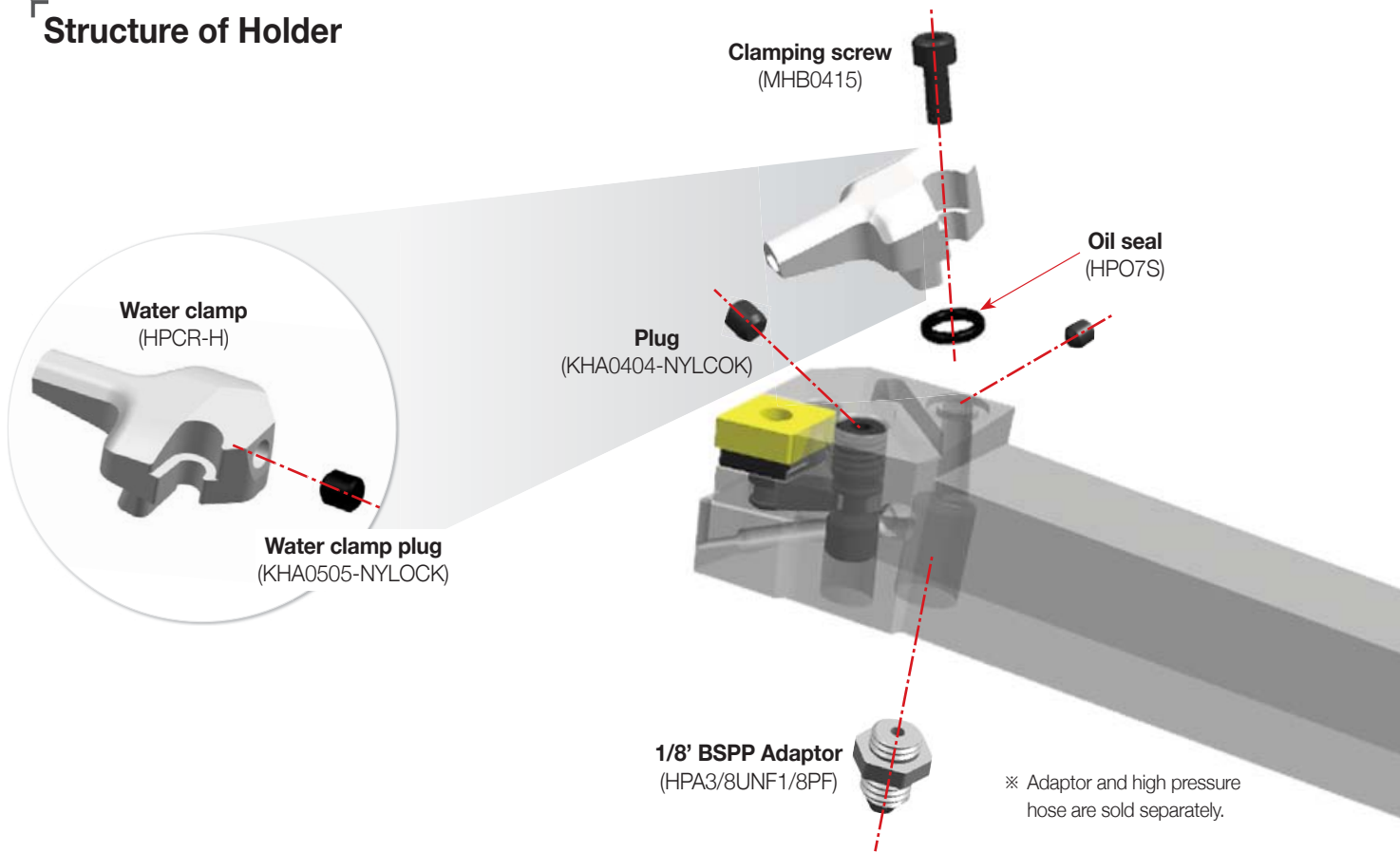

【How to use the water clamp】

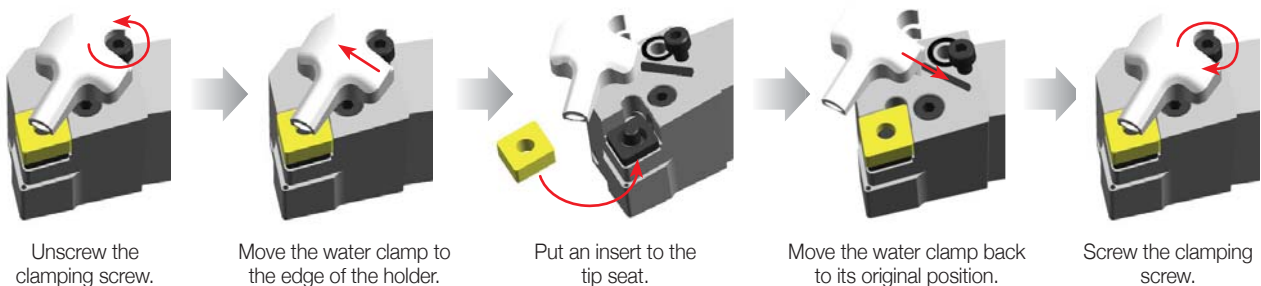

Features

- Increased tool life due to the direct spraying coolant of the edge of insert
- Improved chipping resistance and limited notch wear
- High feed machining due to spraying coolant to the part of the nose R intensively
- Better chip control with high pressure in machining

Water clamp

- The optimal distance between the insert and the jet orifice and the ideal place of the jet orifice
- Maximized pressure of coolant due to the streamlined jet orifice
- Easy to clamp an insert for sliding clamp system

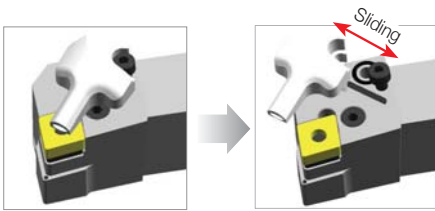

The original position of water clamp

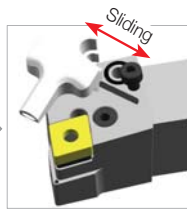

The position of placing insert

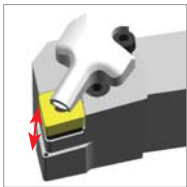

Optimal position and distance of spraying

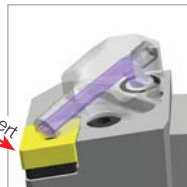

Oval direct spray

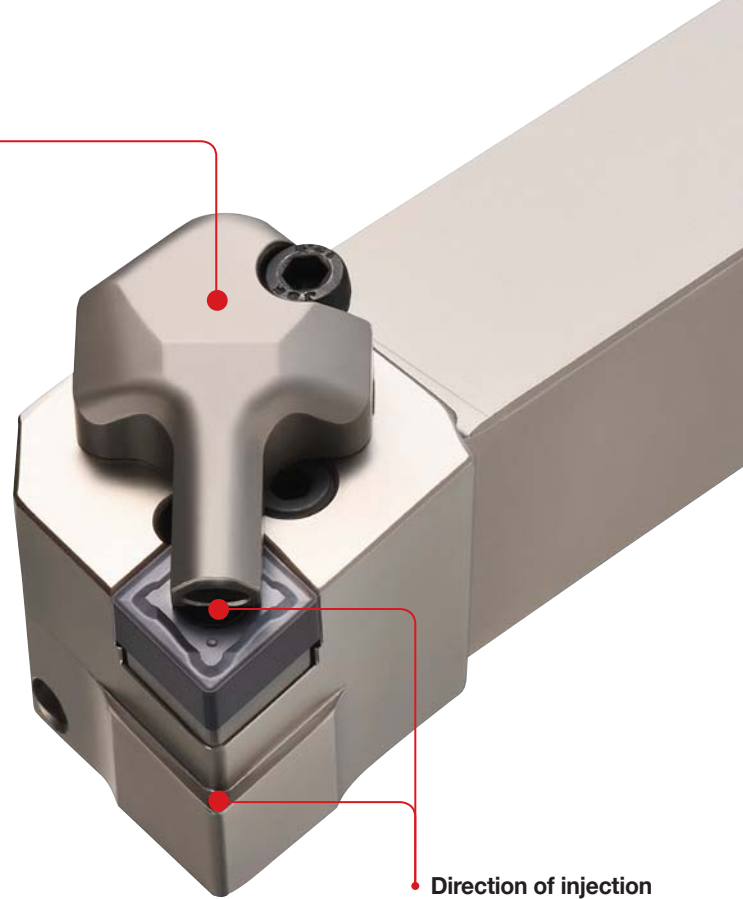

Direction of injection

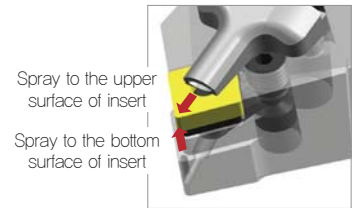

Spray to the upper surface of insert
Spray to the bottom surface of insert

MAX 300 bar

Workpiece	The minimum pressure	The maximum pressure
P	50	300
M	70	
K	60	
N	50	
S	70	



Improved chip control

- **Workpiece** HRSA (Inconel718, HRC42)
- **Cutting conditions** vc (m/min) = 50, fn (mm/rev) = 0.25, ap (mm) = 2, wet (70 bar)
- **Tool**
Insert CNMG120408-VP4
Holder PCLNR2525-M12-KHP



[10 bar]

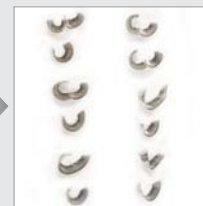

[70 bar]

Performance Evaluation

Wear resistance

- **Workpiece** HRSA (Inconel718, HRC42)
- **Cutting conditions** vc (m/min) = 50, fn (mm/rev) = 0.25, ap (mm) = 2, wet (70 bar)
- **Tool** **Insert** CNMG120408-VP4 **Holder** PCLNR2525-M12-KHP

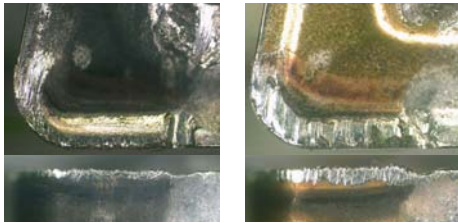

[KORLOY]

[Competitor A's]



[Competitor B's]

[Competitor C's]

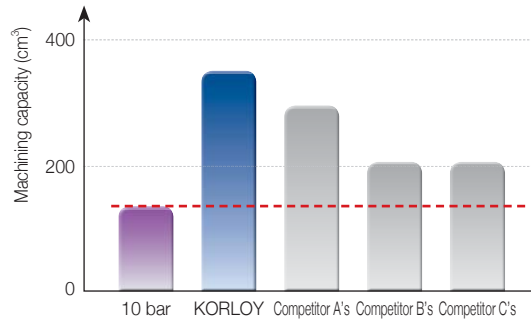

Increased wear resistance

- ▶ Tool life increases up to 60% compared to competitor's in HRSA (Inconel etc.) machining.
- ▶ Decreased notch wear and wear on the nose radius and increased chipping resistance

Chip control

- **Workpiece** HRSA (Inconel718, HRC42)
- **Cutting conditions** vc (m/min) = 50, fn (mm/rev) = 0.25, ap (mm) = 2
- **Tool** **Insert** CNMG120408-VP4 **Holder** PCLNR2525-M12-KHP

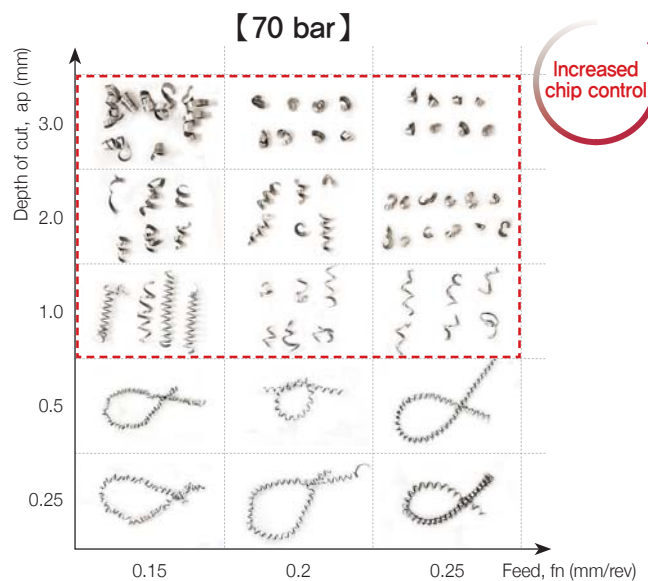
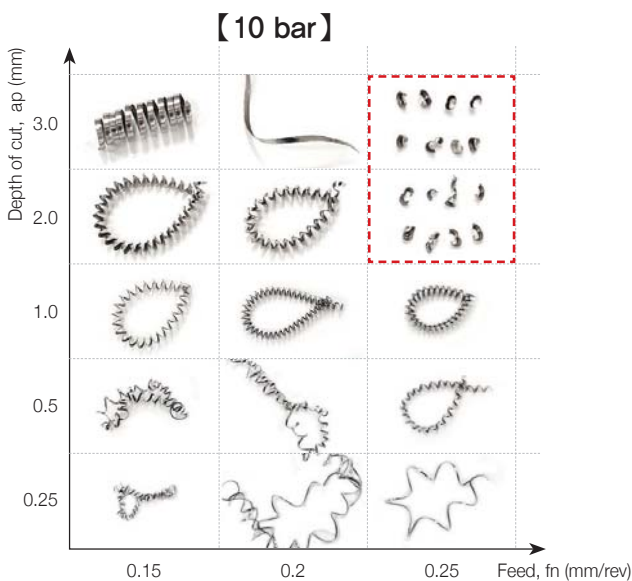

Increased chip control

- ▶ Preventing early fracture of the tool and workpiece due to long chip
- ▶ Longer tool life and improved chip control with direct spraying coolant to the nose R of the insert instead of spraying on the top and bottom sides of the insert

Holder Selection Guide

— KHP — Lever lock system — Double clamp system — Screw on system — Multi lock system

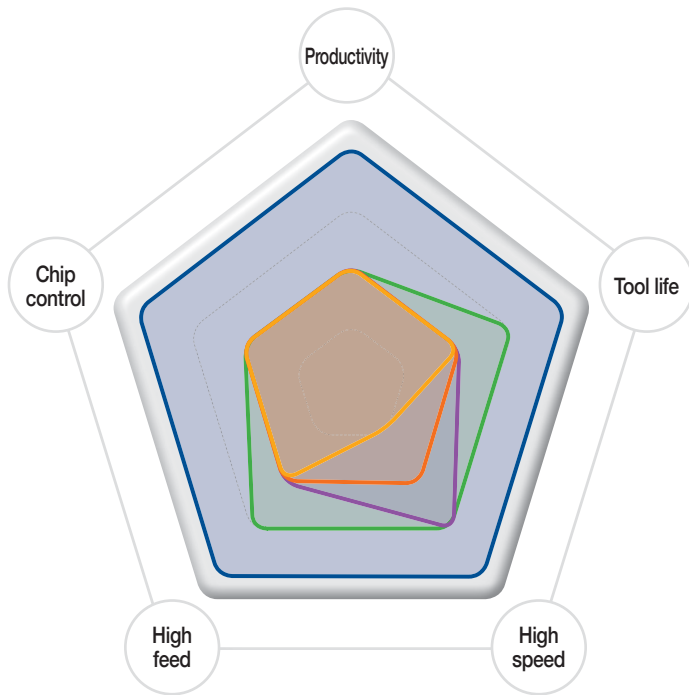

KHP ^{new}

- Longer tool life
- Better chip control



Lever lock system

- Easy to clamp



Double clamp system

- Solid clamping force
- Easy to clamp



Screw on system

- For small diameter internal machining



Multi lock system

- Solid clamping force



Tools	Productivity	Tool life	High speed	High feed	Chip control
KHP ^{new}	★★★★★	★★★★★	★★★★★	★★★★★	★★★★★
Lever lock system	★★	★★	★★★	★★	★★
Double clamp system	★★	★★★	★★★	★★★	★★
Screw on system	★★	★★	★	★★	★★
Multi lock system	★★	★★	★★	★★	★★

Application Examples

Aviation turbine case

- **Workpiece** HRSA (Inconel718, HRC42)
- **Cutting conditions** vc (m/min) = 50~80, fn (mm/rev) = 0.25, ap (mm) = 2, wet (70 bar)
- **Tool** **Insert** CNMG120408-VP4 (PC8115) **Holder** PCLNR2525-M12-KHP

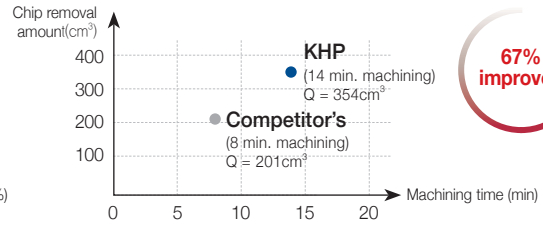
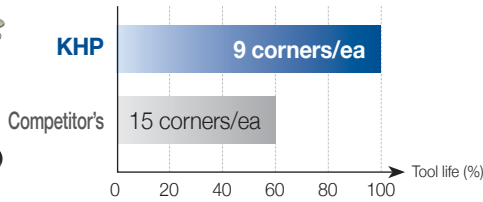

67% improved

▶ 67% longer tool life per corner

Aviation turbine disc

- **Workpiece** HRSA (Inconel718, HRC42)
- **Cutting conditions** vc (m/min) = 50~80, fn (mm/rev) = 0.25, ap (mm) = 2, wet (70 bar)
- **Tool** **Insert** CNMG120408-VP4 (PC8115) **Holder** PCLNR2525-M12-KHP

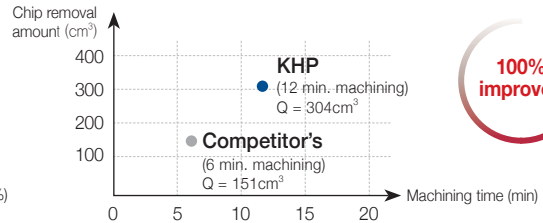
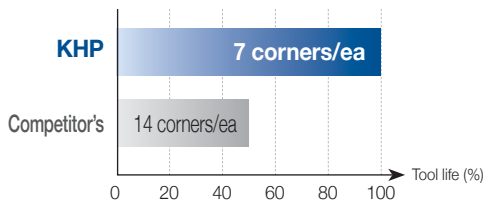

100% improved

▶ 100% longer tool life per corner

Aviation turbine spool

- **Workpiece** HRSA (Inconel718, HRC42)
- **Cutting conditions** vc (m/min) = 50~80, fn (mm/rev) = 0.25, ap (mm) = 2, wet (70 bar)
- **Tool** **Insert** CNMG120408-VP4 (PC8115) **Holder** PCLNR2525-M12-KHP

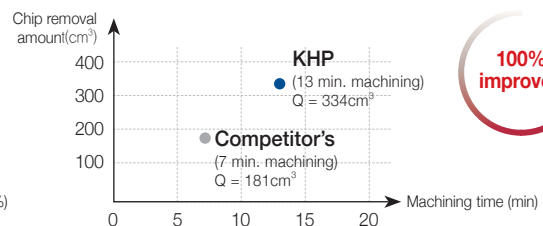
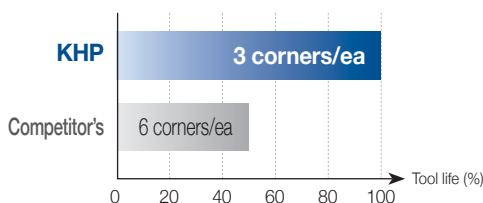

100% improved

▶ 100% longer tool life per corner

Application Range

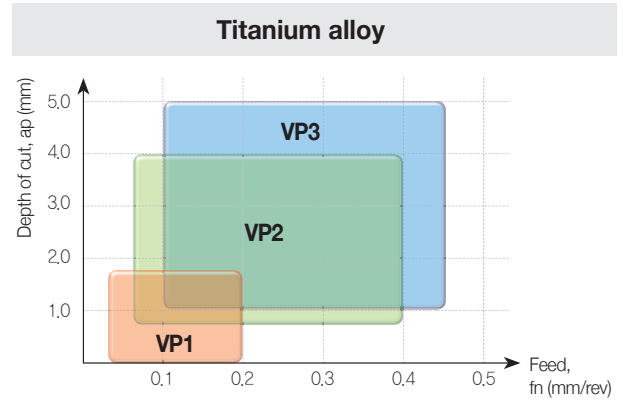
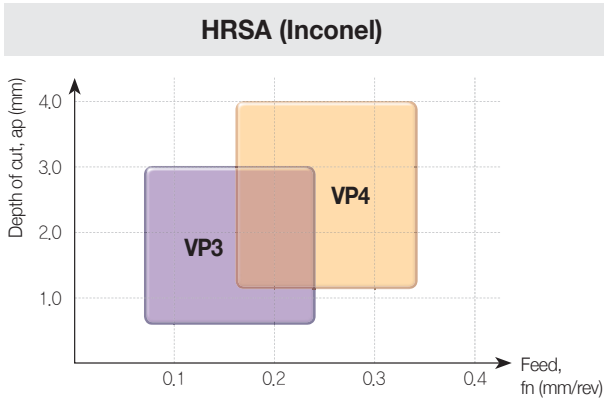

Grade Line-up

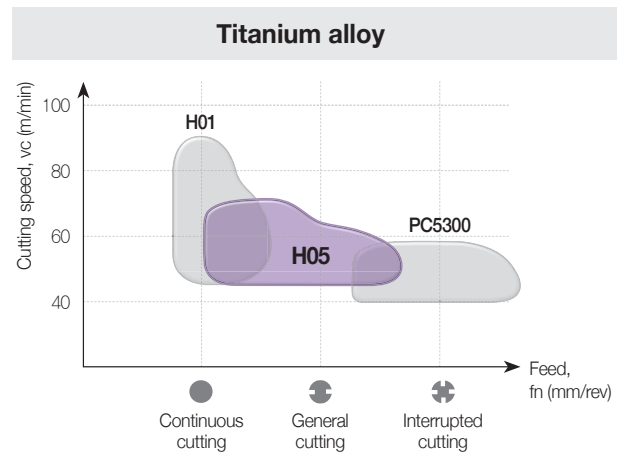
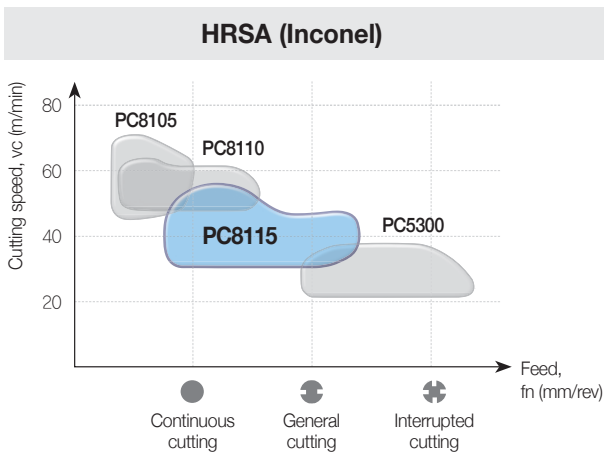

【Chip Breaker Comparison (HRSA/Titanium alloy)】

Application	KORLOY	Competitor A's	Competitor B's	Competitor C's	Competitor D's	Competitor E's	Competitor F's	Competitor G's
Roughing	VP4	SMR	RS, GJ	TF	MS	ET	MR4	NRT, NRS
Medium cutting	VP3	SM	MS	VL	MU	EM	MR3	NMS
Medium cutting to finishing	VP2	NGP	MJ	PP	TK	ML	MF1	NMT
Finishing	VP1	SF	LS, FJ	SF	MQ	EA	M1	NFT

【Grade Comparison (HRSA)】

ISO	KORLOY	Competitor A's	Competitor B's	Competitor C's	Competitor D's	Competitor E's	Competitor F's	Competitor G's
S05	PC8105	S05F	MP9005 VP05RT	IC808	PR1305	TT5080	TS2000	WSM10
S10	PC8110	GC1105	VP10RT	IC907	PR1310			
S15	PC8115	GC1115	MP9015	-	-			

【Grade Comparison (Titanium)】

ISO	KORLOY	Competitor A's	Competitor B's	Competitor C's	Competitor D's	Competitor E's	Competitor F's	Competitor G's
S05	H01	-	-	-	-	-	-	-
S10	H05	H13A	MT9015	IC20	-	TT5080	THR	WS10
S15	PC5300	GC1125	RT9015	IC908	PR1125 PR1325	TT9030 TT9080	CP500 TS2500	WSM20

How to Clamp the KHP

- Easy to clamp with 3 types of installation system
- The banjo type hose provides wider area for machining than other types.

Straight to straight (S-S)



[Pic.1]

Straight to banjo (S-B)



[Pic.2]

Banjo to banjo (B-B)



[Pic.3]

- ※ Blank including a fixed oil seal provides easy clamping.
- ※ Banjo screws provide easy clamping and clamping a holder to the turning machine with various types of blanks.

Components of KHP

- The components of high pressure coolant are sold separately.
- Various components are available according to different machining sites and uses machining with high pressure coolant.

Designation	Shape	Hose length	High pressure hose	Blank	Adaptor	Banjo screw	Copper washer	Pic No.		
HPH3/8UNF-200-SET	S S	200 mm	1 EA	1 EA	2 EA	-	-	1		
HPH3/8UNF-250-SET		250 mm								
HPH3/8UNF1/8PF-200-SET	S B	200 mm			1 EA	1 EA	1 EA	1 EA	3 EA	2
HPH3/8UNF1/8PF-250-SET		250 mm								
HPH1/8PF-200-SET	B B	200 mm			-	2 EA	5 EA	-	3	
HPH1/8PF-250-SET		250 mm								

PCLNR



CN□□

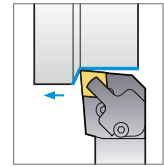
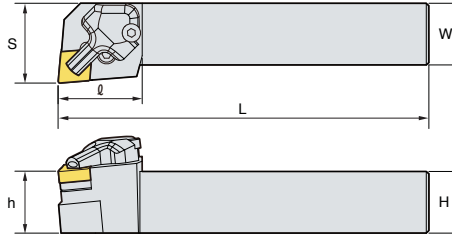
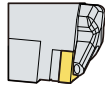

95°

R type insert
(mm)

Designation	Stock	H	W	L	S	h	q	Insert	Lever	Screw	Shim	Shim pin	Wrench	Shim pin punch	Clamp	Clamping screw	Oil seal	Plug
PCLNR 2525-M12-KHP	●	25	25	150	32	25	34	CN□□1204□□										
PCLNR 3232-P12-KHP		32	32	170	40	32	34											

● : Stock items

PDJNR



DN□□

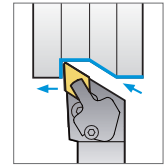
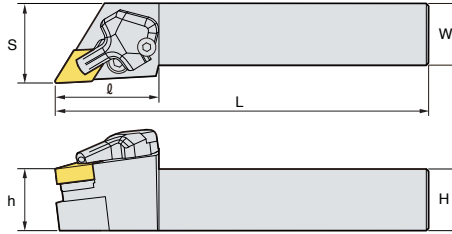
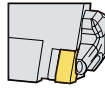

93°

R type insert
(mm)

Designation	Stock	H	W	L	S	h	q	Insert	Lever	Screw	Shim	Shim pin	Wrench	Shim pin punch	Clamp	Clamping screw	Oil seal	Plug										
PDJNR 2525-M11-KHP		25	25	150	32.25	25	42	DN□□1104□□																				
2525-M1504-KHP	●	25	25	150	32.25	25	42	DN□□1504□□											LV3AN	VHx0617N	SD32N	SP3	HW20L HW25L HW30L	LSPS3	HPCR-H	MHB0415	HPO7S	KHA0404-NYLOCK
2525-M1506-KHP	●	25	25	150	32.25	25	42	DN□□1506□□											LV4BN	VHx0821N	SD42N SD43N	SP4N	HW20L HW30L	LSPS4				

● : Stock items

PWLNR



WN□□

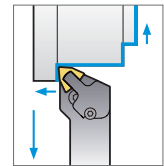
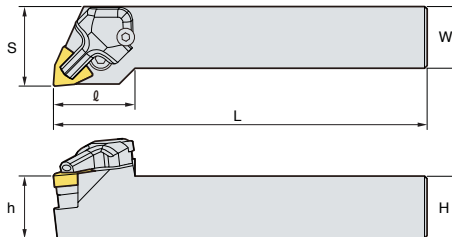
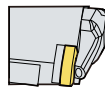

95°

R type insert
(mm)

Designation	Stock	H	W	L	S	h	q	Insert	Lever	Screw	Shim	Shim pin	Wrench	Shim pin punch	Clamp	Clamping screw	Oil seal	Plug
PWLNR 2525-M08-KHP	●	25	25	150	32.25	25	33	WN□□0804□□										
PWLNR 3232-P08-KHP		32	32	170	39.25	32	33											

● : Stock items

SVJBR



VB□□

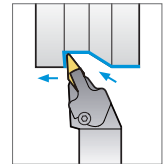
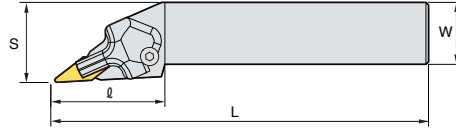

93°

R type insert
(mm)

Designation	Stock	H	W	L	S	h	ℓ	Insert	Screw	Shim screw	Shim	Wrench	Clamp	Clamping screw	Oil seal
SVJBR 2525-M16-KHP	●	25	25	150	32.5	25	46.5	VB□□1604□□	FTGA03512	SHXN0509F	SV32S	TW15P HW30L HW35L	HPCR-H	MHB0415	HPO7S

● : Stock items

Parts

Parts	Designation	Shape of parts
Adaptor	HPA3/8UNF1/8PF	
Blank	HPB1/8PF	
Banjo screw	HPZ1/8PF	
Copper washer	HPW1/8PF	

High Pressure Hose



The shape of the high pressure hose	Length	Standard S	Standard B
Straight to straight (S-S) (HPH3/8UNF)	S	3/8 UNF	-
	200 mm		
Straight to banjo (S-B) (HPH3/8UNF1/8PF)	S	3/8 UNF	1/8 PF
	200 mm		
Banjo to banjo (B-B) (HPH1/8PF)	B	-	1/8 PF
	200 mm		
	250 mm		

! Notice

- Use a standard spanner in clamping.
- Be careful of spraying coolant injected by the residual pressure in using high pressure coolant.
- Clamp the parts tightly.
- Clean the turning machine before clamping.
- The O-ring is included in the parts. Don't have to purchase it separately.

Recommended High Pressure Pump System

- These 2 recommended systems.
- Customers can select a filter, pressure, and discharge according to their cutting conditions

Brand	Kemtech	
System	VF-series	BF-series
Design		
Model no.	VF 70-60 DF	CF 35-25
Filter	Double bag filter	Cyclone filter
Pressure (bar)	70 (Standard pressure)	35 (Standard pressure)
Discharge (ℓ/min)	60 (Standard discharge)	25 (Standard discharge)
Features	<ul style="list-style-type: none"> - Suitable for high precision HRSA machining - Variable pressure for the dia. of tool 	<ul style="list-style-type: none"> - Suitable for high precision HRSA machining - Variable pressure for the dia. of tool - Applying a cyclone filter - No filter supplies
Automatic pressure control	O	O
Options	- Chiller, Inverter multistage control	<ul style="list-style-type: none"> - Chiller, Inverter multistage control - A tank attached model is applicable.



Holystar B/D, 1350, Nambusunhwan-ro, Geumcheon-gu, Seoul, 08536, Korea
 Tel : +82-2-522-3181 Fax : +82-2-522-3184, +82-2-3474-4744 Web : www.korloy.com E-mail : export@korloy.com

KORLOY AMERICA

620 Maple Avenue, Torrance, CA 90503, USA
 Tel : +1-310-782-3800 Toll Free : +1-888-711-0001 Fax : +1-310-782-3885
 E-mail : sales.kai@korloy.com

KORLOY INDIA

Plot NO.415, Sector 8, IMT Manesar, Gurgaon 122051, Haryana, India
 Tel : +91-124-4391790 Fax : +91-124-4050032
 E-mail : sales.kip@korloy.com

KORLOY VIETNAM

No. 133, Le Loi street, Hoa Phu ward, Thu Dau Mot city,
 Binh Duong, Vietnam
 Tel : +84-96-856-1230 E-mail : sales.kvc@korloy.com

KORLOY CHILE

Av. Providencia 1650, Office 1009, 7500027
 Providencia-Santiago, Chile
 Tel : +56-229-295-490 E-mail : sales.kcs@korloy.com

KORLOY EUROPE

Gablonzer Str. 25-27, 61440 Oberursel, Germany
 Tel : +49-6171-277-83-0 Fax : +49-6171-277-83-59
 E-mail : sales.keg@korloy.com

KORLOY BRASIL

Av. Aruana 280, conj.12, WLC, Alphaville, Barueri,
 CEP06460-010, SP, Brasil
 Tel : +55-11-4193-3810 E-mail : sales.kbl@korloy.com

KORLOY TURKEY

Orucreis Mah. Vadi Cad. No: 108 Istanbul Ticaret Sarayi
 Kat 5 No: 318 Giyimkent Sitesi-Esenler/Istanbul, Turkey
 Tel : +90-212-438-5197 E-mail : service@korloy.com.tr

KORLOY FACTORY QINGDAO

Ground Dongjing Road 56(B) District Free Trade Zone. Qingdao, China
 Tel : +86-532-86959880 Fax : +86-532-86760651
 E-mail : pro.kfq@korloy.com

KORLOY FACTORY INDIA

Plot No. 415, Sector 8, IMT Manesar, Gurgaon 122051, Haryana, India
 Tel : +91-124-4391790 Fax : +91-124-4050032
 E-mail : pro.kim@korloy.com