

Insert for ultra-precision automatic Swiss lathe machining
(medium cutting to finishing)

FS/MS Chip Breaker

(+Auto Tools KHP Coolant)

KORLOY
TECH-NEWS



- Highly precise grinding technology realizes sharp cutting edge and reduced cutting heat increases tool life and surface finish.
- Chip breaker designed for good chip flow ensures chip control even in cutting conditions with poor chip evacuation.
- High precision FS and MS chip breakers actualize high precision machining minimizing dimension deviations.

Insert for ultra-precision automatic Swiss lathe machining (medium cutting to finishing)

FS/MS Chip Breaker

As the industries continue to advance, the demand for unmanned automatic lathe and machining hard-to-cut materials for small precise components of automobile, medical appliance and general machinery have been increasing. Especially, pure titanium (5832-2) and titanium alloy (5832-3) used for high precision parts such as implants are known to have poor machinability due to high cutting heat and welding which requires high precision and good surface finish. Also, machining components of automobile and general machinery require stable tool life and chip control even in high speed and high feed cutting conditions.

KORLOY's newly launched chip breakers, ultra-precision MS and FS for Auto Tools realizes high machinability in ultra-precision components such as implants, automobiles and general machinery made of hard-to-cut materials machining.

The **FS chip breaker** has a variable elevated triangular pyramid shape which provides excellent chip control and stable tool life in various cutting range with alloy steel and stainless steel.

The **MS chip breaker** has a special 3D structured design to enhance chip evacuation per variety of cutting

path and implemented high precise grinding process to develop a detailed nose R shape with sharp edge. With these, it could minimize cutting heat and built up edge occurrence while machining titanium.

It also prevents micro chipping by adapting ultra-fine substrate which equalized refined structure. Special surface treatment added PVD also ensures excellent surface roughness and enhanced tool life with high hardness and treat anti-oxidation.

In addition, tight tolerance and deviation management in producing inserts with FS and MS chip breakers minimizes dimension deviation of corners and products providing convenience to users as it allows users to not be concerned about tool offset in changing insert corners.

The chip breakers for Auto Tools would provide the best solution to customers in necessity to precisely machine hard-to-cut materials with combination of premium level management in design, manufacturing, and quality, and grades matching like PC8110 and PC5300 having high hardness and thermal resistance.



Longer tool life

- Ultra-fine substrate and high hardness coating
- Reduced cutting heat due to sharp cutting edge

Better surface finish

- Mirror-liked finished cutting edge through special surface treatment

High precise tool deviations

- Minimized dimension deviations for each insert corners and items

Improved chip control

- Excellent chip cutting and evacuation due to three-dimensional shaped design

Code system

【Insert】

V	C	G	T	11	03	01	M	F	N	-	FS
Insert shape	Relief angle	Tolerance	Cross section type	Cutting edge length, diameter of inscribed circle	Height of cutting edge	Nose radius (Nose R)	Nose R tolerance M: Minus	Edge preparation F: Sharp	Hand R: Right L: Left N: Neutral		Chip breaker

Insert tolerance

(mm)

Type	Designation	d (Inscribed circle)	t (Height of cutting edge)	m (m size)	r (Nose R)	Geometries
High precision	VCGT110301-MS	±0.025	±0.04	±0.025	±0.02	
Ultra-precision	VCGT110301 MFN -MS	±0.02	±0.02	±0.02	0 ~ -0.02	
	VCGT120301 FN -MS	±0.02	±0.02	±0.02	±0.01	

※ Ultra-precision insert with tight tolerance and deviation management is recommended in high precision and low deviation machining.

Application range

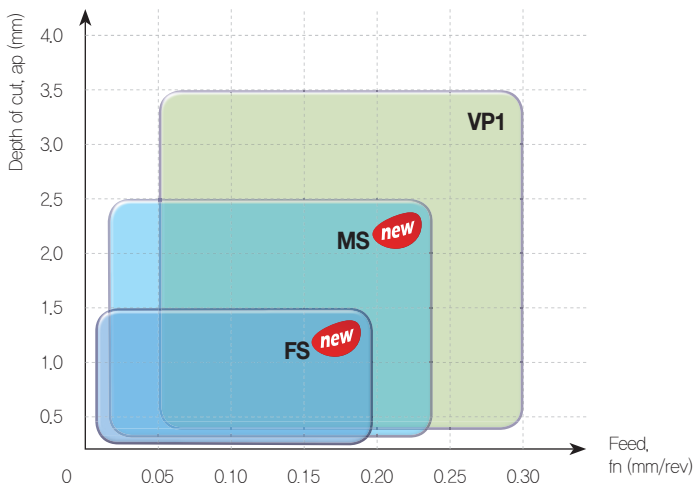

Machining	Chip breaker	ap (mm)	fn (mm/rev)
Medium cutting (for toughness)	VP1	0.3 - 3.5	0.05 - 0.30
Medium cutting (for surface roughness)	MS	0.2 - 2.5	0.03 - 0.25
Finishing	FS	0.1 - 1.5	0.01 - 0.20

FS Chip breaker **new**



For finishing (for surface roughness)

- 1st recommended chip breaker for chip control
- Better surface roughness, surface finish and chip control

MS Chip breaker **new**



For medium cutting (for surface roughness)

- 1st recommended chip breaker
- Surface roughness in medium cutting range

VP1 Chip breaker



For medium cutting (for reinforced cutting edge)

- 2nd recommended chip breaker for medium cutting
- For strength of cutting edge in medium cutting

Features

FS Chip breaker (for finishing)

- Chip breaker for ultra-precision automatic Swiss lathe machining (for lower depth of cut and lower feed cutting range than VP1 and MS)
- Available for various workpieces, P, M and S
- Reduced cutting load and good surface finish due to sharp cutting edge

Variable elevated triangular pyramid shape

- Applicable for various cutting range due to optimally designed chip breaker
- Enhanced chip evacuation function per variation of cutting depth
- Enhanced chip control with low depth of cut
- Lowered cutting load in high feed machining

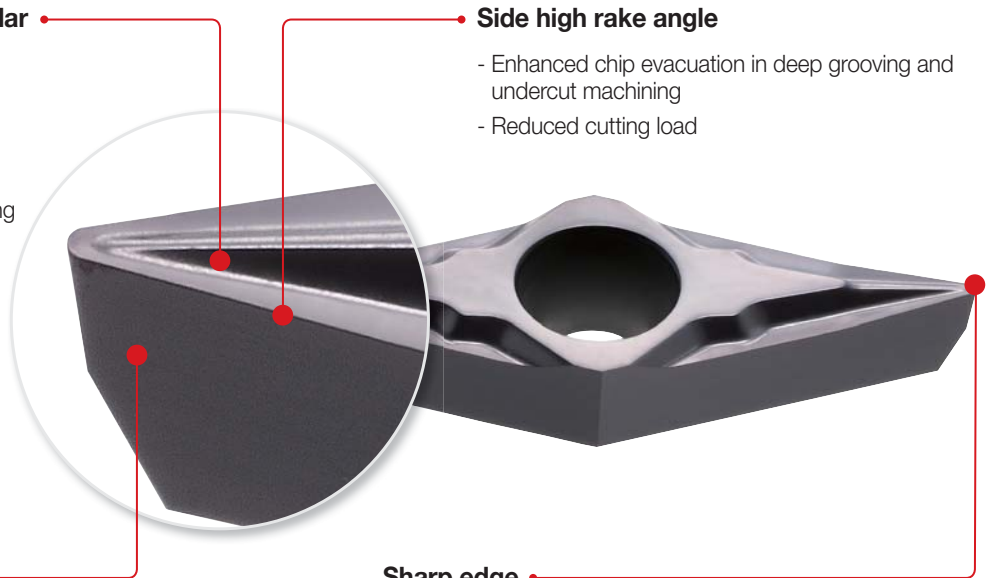

Side high rake angle

- Enhanced chip evacuation in deep grooving and undercut machining
- Reduced cutting load

Side grinding

- Periphery grinding G class
- High precision grinding

Sharp edge



- Reduced cutting resistance
- Improved chip control

High precision grinding

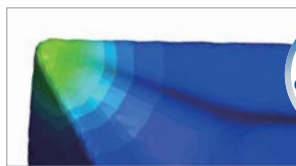

[FS]

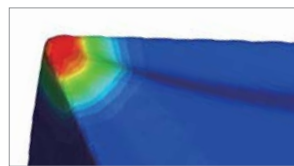

[Competitor]

Detailed nose R shape with sharp edge

- Lowered cutting force due to detailed nose R
- Reduced cutting resistance from sharp edge
- Enhanced tool life with low cutting heat

2 step rear chip breaker

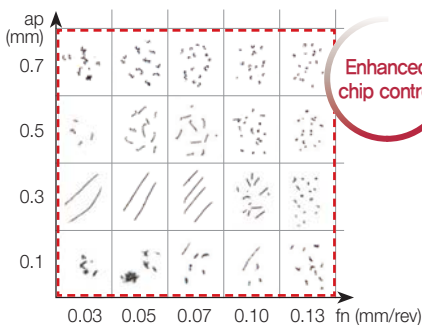

[FS]

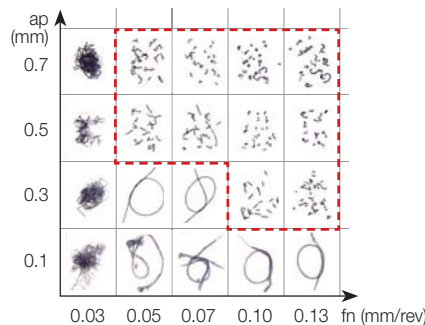

[Competitor]

Improved chip breaker in various cutting range

- Excellent chip control in low cutting conditions due to 1 step rear shape
- Enhanced chip evacuation in high cutting conditions due to 2 step shape
- Chip control in wider range than competitor

Features

MS Chip breaker (for medium cutting to finishing)

- Sharp cutting edge with welding resistance reducing the cutting heat is necessary for machining hard-to-cut materials.
- Chip evacuation is increased in low to high feed cutting conditions.

Sharp cutting edge

- Decreased cutting heat
- Minimized welding

Flank surface grinding

- G grade of periphery grinding
- Precise grinding

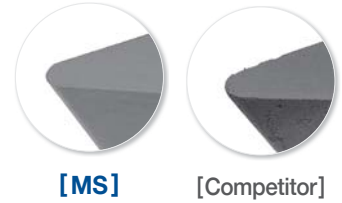

2-level angle back area

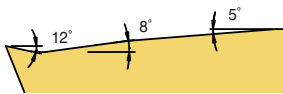

- Improved chip curl and chip control in low feed cutting range
- Better chip evacuation in high feed cutting range
- Reduced cutting resistance
- Protected cutting edge without chip blockage

Precise nose R shape



Sharp cutting edge



Improved surface finish

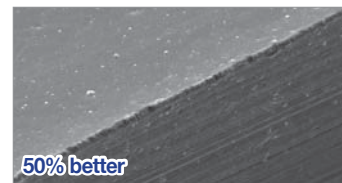

Special coating surface treatment technology

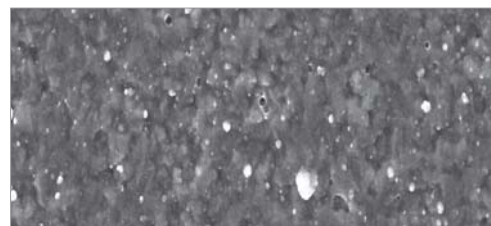
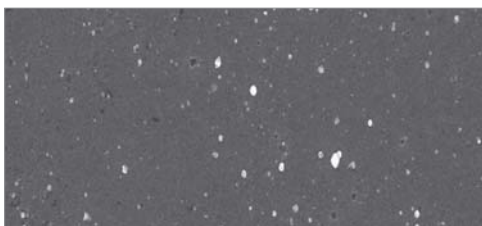

[Auto Tools]

[General tool]

► Precise nose R, sharp cutting edge and better surface finish realize high productivity and decrease dimension deviation.

Performance evaluation (FS Chip breaker)

Chip control

- **Workpiece** Alloy steel (S42CrMo4), Stainless steel (X5CrNi18-9)
- **Cutting conditions** vc (m/min) = 100, n (rpm) = 1,200, fn (mm/rev) = 0.03-0.13, ap (mm) = 0.5-1.0, wet
- **Tools** Insert DCGT11T302-FS (PC5300) Holder SDJCR1212-X11A

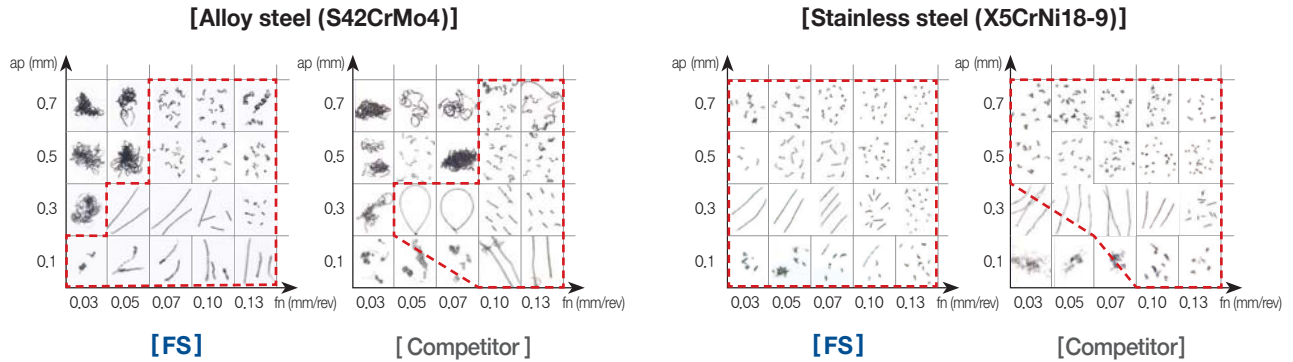

► 2 step rear angle shape ensures excellent chip control in alloy steel and stainless steel machining with from low to high depth of cut.

Workpiece size and surface finish

- **Workpiece** Stainless steel (X12CrS13)
- **Cutting conditions** vc (m/min) = 80, n (rpm) = 1,000, fn (mm/rev) = 0.05, ap (mm) = 0.1, wet
- **Tools** Insert VCGT110301-FS (PC8110) Holder SVJCR1212-X11A

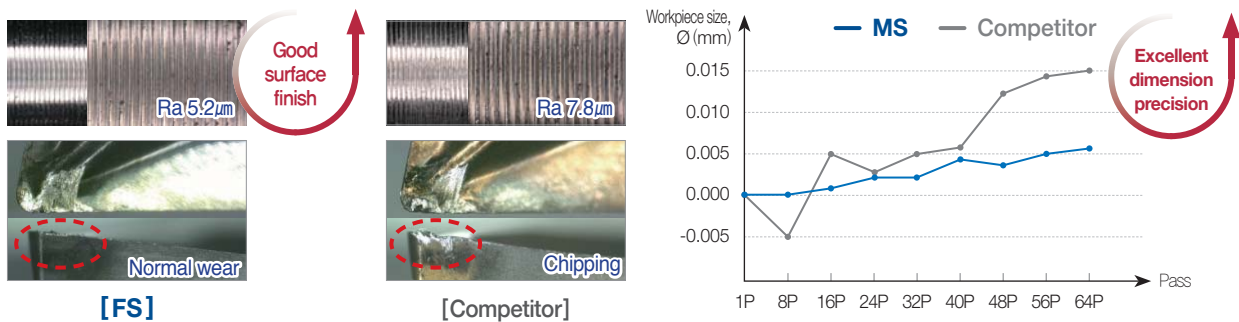

► 3-dimensional and sharp cutting edge reduces cutting load and cutting heat ensuring stable machining and surface finish.

Wear resistance

- **Workpiece** Alloy steel (S42CrMo4)
- **Cutting conditions** vc (m/min) = 100, n (rpm) = 1,000, fn (mm/rev) = 0.05, ap (mm) = 0.5, wet
- **Tools** Insert CCGT09T304-FS (PC8110) Holder SCLCR1212-X09A

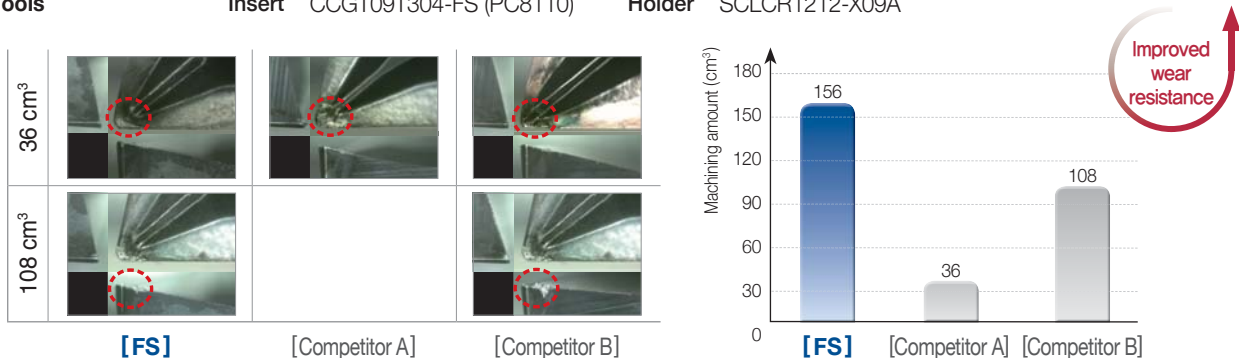

► FS chip breaker applied mirror-like finished cutting edge, ultra-fine substrate and high hardness coating ensure longer tool life than competitor's one.

Performance evaluation (MS Chip breaker)

Wear resistance

- **Workpiece** Pure titanium (5832-2)
- **Cutting conditions** vc (m/min) = 100, n (rpm) = 3,500, fn (mm/rev) = 0.03, ap (mm) = 0.5, wet
- **Tools** Insert VCGT1203008FN-MS (PC8110) Holder SVJCR1212-X12A

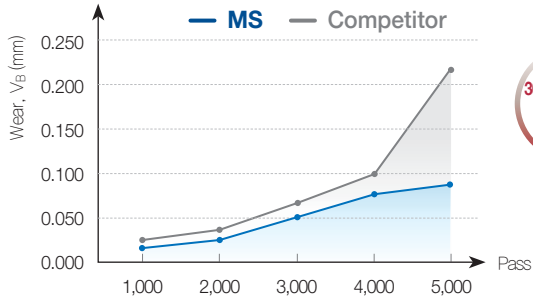

30% improved wear resistance

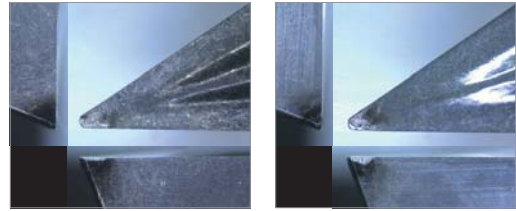

[MS]

[Competitor]

▶ Ultra-fine substrate and high hardness coating ensure stable tool life.

Chip control and surface finish

- **Workpiece** Stainless steel (X5CrNi18-9)
- **Cutting conditions** vc (m/min) = 120, n (rpm) = 4,000, fn (mm/rev) = 0.03, ap (mm) = 0.1, 0.3, 0.5, wet
- **Tools** Insert VCGT120302FN-MS (PC5300) Holder SVJCR1212-X12A



[MS]

Good chip control



[Competitor]

▶ Three-dimensional shaped design of chip breaker increases chip evacuation.



[MS]

Good surface finish

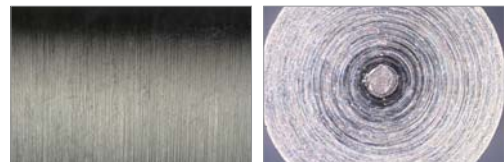

[Competitor]

▶ Sharp and mirror-like finished cutting edge improves surface finish.

Dimension precision

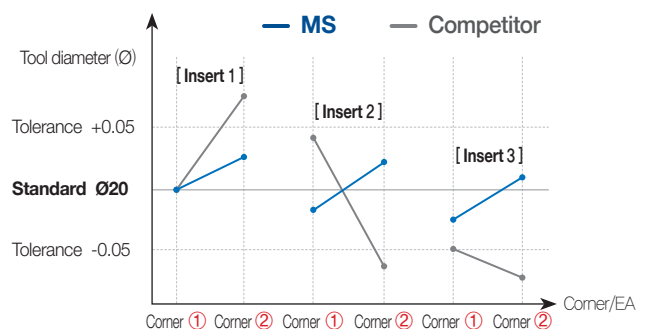
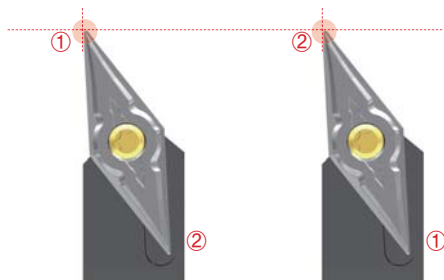

▶ Changing tool offset in switching insert corners and items is not necessary using MS chip breaker due to tight dimension deviation management.

The comparison of chip breaker

Category	Application	KORLOY	Competitor A	Competitor B	Competitor C	Competitor D	Competitor E	Competitor F	Competitor G
Chip breaker	Medium cutting (for toughness)	VP1	GF	SM	FS	-None	FC	AM3	FN-None
	Medium cutting (for surface finish)	MS new	GQ	SH	LS	01	SC	AM3	FN-None
	Finishing	FS new	SK, CF	SA, SL	SMG, FJ	JS	SI	YL	-
Grade	General cutting	PC5300	PR1125	TT9020	VP15TF	SH725	AC1030U	DM4	D60
	S10	PC8110	PR1310	TT5080	VP10RT	SH730	AC510U	ZM3	D20

Grade features

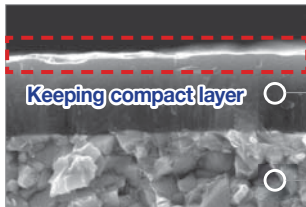

PC5300

- Coating layer with oxidation resistance and high hardness at high temperature
 - Good oxidation resistance in steel, cast iron, stainless steel and HRSA machining
- Applying ultra-fine high toughness substrate and surface treatment technology on coating layer
 - Improved welding and chipping resistance

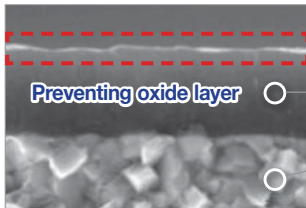

PC8110

- Coating layer with good surface finish, high hardness at high temperature and oxidation resistance reduces wear at high temperature.
- Controlling ultra-fine microstructure regularly ensures stable machinability, high chipping and wear resistance.

Grades and recommended cutting conditions

Workpiece	Grade	Recommended cutting speed, vc (m/min)				
		50	100	200	300	600
P Steel	PC8110		80	200		
	PC5300		60	160		
M Stainless steel	PC8110		80	130		
	PC5300		80	160		
K Cast iron	PC8110		100	180		
	PC5300		90	160		
N Non-ferrous metal	H05			150		600
	PC8110			150		600
S HRSA	H05	35	65			
	PC8110	35	65			
	PC5300	25	55			

Auto Tools chip breaker selection guide

— FS — MS — VP1 — KM — KF

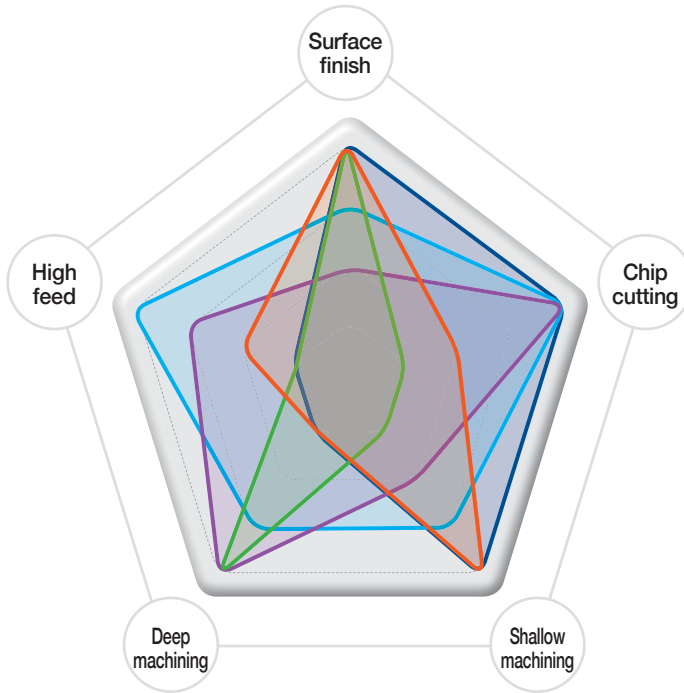

FS ^{new}



- For finishing (for surface finish)
- Inducing soft cutting by depth of cut
- Increasing surface finish due to three-dimensional cutting edge design
- Available in various machining ranges from optimal chip breaker shape

MS ^{new}



- For medium cutting (for surface finish)
- Preventing welding in Titanium machining
- Improving chip evacuation in high feed machining
- Protecting cutting edge from structure without chip blockage

VP1



- For medium cutting (for reinforced cutting edge)
- Preventing chipping due to reinforced cutting edge in machining general alloy steel and stainless steel

KM



- For finishing and medium cutting
- Longer tool life and increased machinability from improved chip flow
- Deep machining due to deep and wide groove

KF



- For finishing
- Low cutting load from sharp cutting edge
- Reduced resistance of chip evacuation in high speed machining
- Good surface finish

ISO	Chip breaker	Surface finish	Chip cutting	Shallow machining	Deep machining	High feed
M class	FS ^{new}	★★★★	★★★★	★★★★	★	★
	MS ^{new}	★★★	★★★★	★★★	★★★	★★★★
	VP1	★★	★★★★	★★	★★★★	★★★
Ground class	KM	★★★★	★	★	★★★★	★
	KF	★★★★	★★	★★★★	★	★★

Application examples (FS Chip breaker)

Stainless steel (X5CrNi18-9)

- **Workpiece use** Component of automobile fuel gauge
- **Cutting conditions** vc (m/min) = 80, n (rpm) = 2,500, fn (mm/rev) = 0.11, ap (mm) = 0.5, wet
- **Tools** **Insert** CCGT09T302-FS (PC5300) **Holder** SCLCL1212-X09A

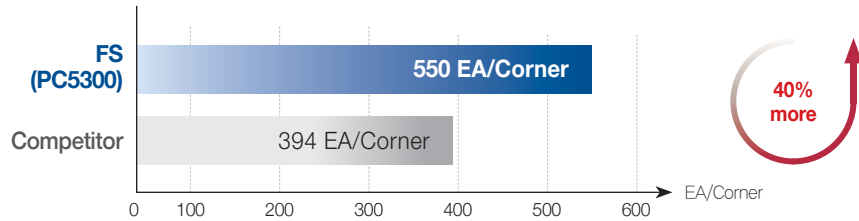

- Prevented welding due to sharp cutting edge and mirror-like finished coating
- Minimized cutting heat in stainless steel machining

Carbon steel (C10)

- **Workpiece use** Component of automobile engine
- **Cutting conditions** vc (m/min) = 100, n (rpm) = 3,000, fn (mm/rev) = 0.1, ap (mm) = 0.5, wet
- **Tools** **Insert** DCGT11T302-FS (PC8110) **Holder** SDJCL1212-X11A

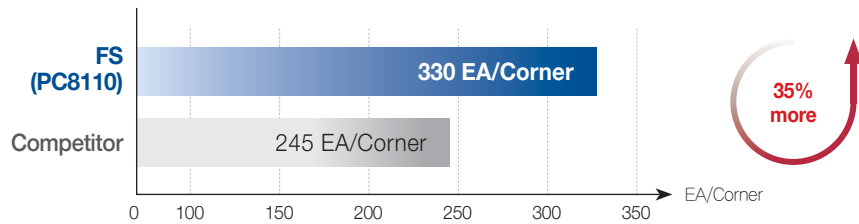

- Excellent chip evacuation due to better chip control

Carbon steel (C45)

- **Workpiece use** Turbo charger roller pin
- **Cutting conditions** vc (m/min) = 260, n (rpm) = 2,000, fn (mm/rev) = 0.1, ap (mm) = 0.5-1.0, wet
- **Tools** **Insert** VCGT110301-FS (PC5300) **Holder** SVJCR1212-X11A

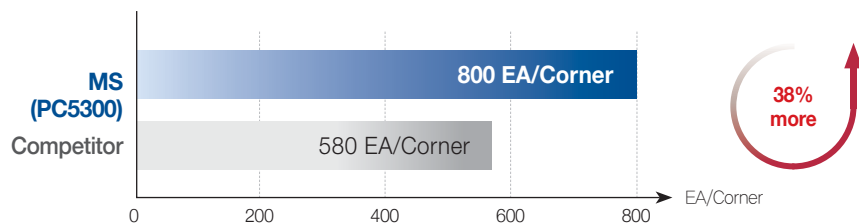

- Prevented welding due to sharp cutting edge and mirror-like finished coating
- Prevented microchipping by ultra-fine substrate and long tool life from high hardness oxidation coating

Application examples (MS Chip breaker)

Pure titanium (5832-2)

- **Workpiece use** Plate
- **Cutting conditions** vc (m/min) = 100, n (rpm) = 4,000, fn (mm/rev) = 0.01, ap (mm) = 1.0, wet
- **Tools** **Insert** VCGT120302FN-MS (PC8110) **Holder** SVJCR1212-X12A

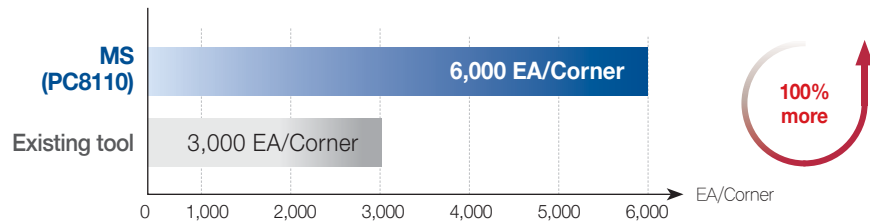

- Sharp cutting edge and mirror-like coating prevent cutting heat and welding.
- Ultra-fine substrate prevents micro chipping and coating layer with high hardness at high temperature and good oxidation resistance increases tool life.

Titanium alloy (5832-3)

- **Workpiece use** Fixture (Implant)
- **Cutting conditions** vc (m/min) = 120, n (rpm) = 5,000, fn (mm/rev) = 0.03, ap (mm) = 0.5, wet
- **Tools** **Insert** VCGT120301FN-MS (PC5300) **Holder** SVJCR1212-X12A

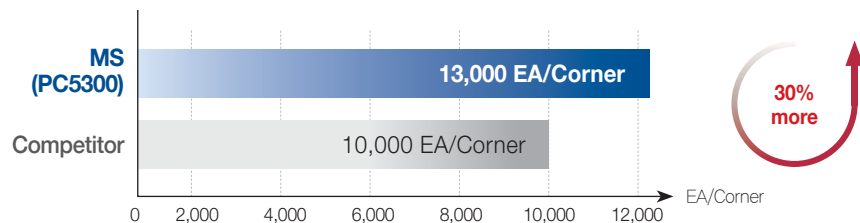

- Sharp cutting edge and mirror-like coating prevent cutting heat and welding.
- Ultra-fine substrate prevents micro chipping and coating layer with high hardness at high temperature and good oxidation resistance increases tool life.

Titanium alloy (5832-3)

- **Workpiece use** Abutment (Implant)
- **Cutting conditions** vc (m/min) = 120, n (rpm) = 5,000, fn (mm/rev) = 0.05, ap (mm) = 0.1, wet
- **Tools** **Insert** VCGT1203008FN-MS (PC8110) **Holder** SVJCR1212-X12A

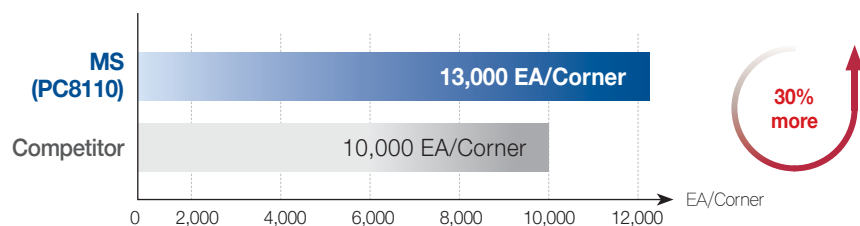
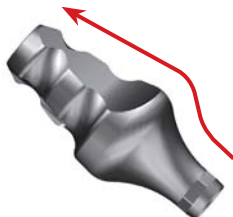

- Sharp cutting edge and mirror-like coating prevent cutting heat and welding.
- Ultra-fine substrate prevents micro chipping and coating layer with high hardness at high temperature and good oxidation resistance increases tool life.

Stock items (FS Chip breaker)

【Ultra-precision insert】

Inserts	Designation	Coated			Dimensions (mm)					Cutting conditions		Geometries	
		PC5300	PC8110	H05	l	d	t	r	d ₁	f _n (mm/rev)	a _p (mm)		
Finishing (Ultra-precision)	CCGT	060201MFN-FS	●	●		6.3	6.35	2.38	<0.1	2.8	0.01-0.18	0.03-1.60	
		060202MFN-FS	●	●		6.2	6.35	2.38	<0.2	2.8	0.02-0.20	0.04-1.70	
		060204MFN-FS	●	●		6.0	6.35	2.38	<0.4	2.8	0.04-0.21	0.06-1.80	
		09T301MFN-FS	●	●		9.8	9.525	3.97	<0.1	4.4	0.01-0.20	0.04-1.80	
		09T302MFN-FS	●	●		9.6	9.525	3.97	<0.2	4.4	0.02-0.23	0.05-2.00	
		09T304MFN-FS	●	●		9.2	9.525	3.97	<0.4	4.4	0.04-0.23	0.08-2.00	
	DCGT	070201MFN-FS	●	●		7.6	6.35	2.38	<0.1	2.8	0.01-0.18	0.03-1.60	
		070202MFN-FS	●	●		7.5	6.35	2.38	<0.2	2.8	0.02-0.20	0.04-1.70	
		11T301MFN-FS	●	●		11.6	9.525	3.97	<0.1	4.4	0.01-0.20	0.04-1.80	
		11T302MFN-FS	●	●		11.4	9.525	3.97	<0.2	4.4	0.02-0.23	0.05-2.00	
		11T304MFN-FS	●	●		11.2	9.525	3.97	<0.4	4.4	0.04-0.23	0.08-2.00	
		11T308MFN-FS	●	●		11.0	9.525	3.97	<0.8	4.4	0.06-0.25	0.10-2.20	
	TCGT	110201MFN-FS	●	●		9.3	6.35	3.18	<0.1	3.4	0.01-0.16	0.03-1.40	
		110202MFN-FS	●	●		9.1	6.35	3.18	<0.2	3.4	0.02-0.18	0.04-1.50	
		110204MFN-FS	●	●		8.6	6.35	3.18	<0.4	3.4	0.04-0.19	0.06-1.60	
	VBGT	110301MFN-FS	●	●		10.8	6.35	3.18	<0.1	2.8	0.01-0.16	0.03-1.40	
		110302MFN-FS	●	●		10.6	6.35	3.18	<0.2	2.8	0.02-0.18	0.04-1.50	
		110304MFN-FS	●	●		11.4	6.35	3.18	<0.4	2.8	0.04-0.19	0.06-1.60	
		160401MFN-FS	●	●		16.3	9.525	4.76	<0.1	4.4	0.01-0.16	0.04-1.80	
		160402MFN-FS	●	●		16.1	9.525	4.76	<0.2	4.4	0.02-0.18	0.05-2.00	
		160404MFN-FS	●	●		15.7	9.525	4.76	<0.4	4.4	0.04-0.19	0.08-2.00	
	VCGT	110301MFN-FS	●	●		10.8	6.35	3.18	<0.1	2.8	0.01-0.16	0.03-1.40	
		110302MFN-FS	●	●		10.6	6.35	3.18	<0.2	2.8	0.02-0.18	0.04-1.50	
		110304MFN-FS	●	●		11.4	6.35	3.18	<0.4	2.8	0.04-0.19	0.06-1.60	
160401MFN-FS		●	●		16.3	9.525	4.76	<0.1	4.4	0.01-0.16	0.04-1.80		
160402MFN-FS		●	●		16.1	9.525	4.76	<0.2	4.4	0.02-0.18	0.05-2.00		
160404MFN-FS		●	●		15.7	9.525	4.76	<0.4	4.4	0.04-0.19	0.08-2.00		

● : Stock item





【High precision insert】

Inserts	Designation	Coated			Dimensions (mm)					Cutting conditions		Geometries	
		PC5300	PC8110	H05	l	d	t	r	d ₁	f _n (mm/rev)	a _p (mm)		
Finishing (High precision)	CCGT	060201-FS	●	●		6.3	6.35	2.38	0.1	2.8	0.01-0.18	0.03-1.60	
		060202-FS	●	●		6.2	6.35	2.38	0.2	2.8	0.02-0.20	0.04-1.70	
		060204-FS	●	●		6.0	6.35	2.38	0.4	2.8	0.04-0.21	0.06-1.80	
		09T301-FS	●	●		9.8	9.525	3.97	0.1	4.4	0.01-0.20	0.04-1.80	
		09T302-FS	●	●		9.6	9.525	3.97	0.2	4.4	0.02-0.23	0.05-2.00	
		09T304-FS	●	●		9.2	9.525	3.97	0.4	4.4	0.04-0.23	0.08-2.00	
	DCGT	070201-FS	●	●		7.6	6.35	2.38	0.1	2.8	0.01-0.18	0.03-1.60	
		070202-FS	●	●		7.5	6.35	2.38	0.2	2.8	0.02-0.20	0.04-1.70	
		11T301-FS	●	●		11.6	9.525	3.97	0.1	4.4	0.01-0.20	0.04-1.80	
		11T302-FS	●	●		11.6	9.525	3.97	0.2	4.4	0.02-0.23	0.05-2.00	
		11T304-FS	●	●		11.6	9.525	3.97	0.4	4.4	0.04-0.23	0.08-2.00	
		11T308-FS	●	●		11.6	9.525	3.97	0.8	4.4	0.06-0.25	0.10-2.20	
	TCGT	110201-FS	●	●		9.3	6.35	2.38	0.1	2.8	0.01-0.16	0.03-1.40	
		110202-FS	●	●		9.1	6.35	2.38	0.2	2.8	0.02-0.18	0.04-1.50	
		110204-FS	●	●		8.6	6.35	2.38	0.4	2.8	0.04-0.19	0.06-1.60	
	VBGT	110301-FS	●	●		11.0	6.35	3.18	0.1	2.8	0.01-0.16	0.03-1.40	
		110302-FS	●	●		11.0	6.35	3.18	0.2	2.8	0.02-0.18	0.04-1.50	
		110304-FS	●	●		11.0	6.35	3.18	0.4	2.8	0.04-0.19	0.06-1.60	
		160401-FS	●	●		16.3	9.525	4.76	0.1	4.4	0.01-0.16	0.04-1.80	
		160402-FS	●	●		16.1	9.525	4.76	0.2	4.4	0.02-0.18	0.05-2.00	
		160404-FS	●	●		15.7	9.525	4.76	0.4	4.4	0.04-0.19	0.08-2.00	
	VCGT	110301-FS	●	●		11.0	6.35	3.18	0.1	2.8	0.01-0.16	0.03-1.40	
		110302-FS	●	●		11.0	6.35	3.18	0.2	2.8	0.02-0.18	0.04-1.50	
		110304-FS	●	●		11.0	6.35	3.18	0.4	2.8	0.04-0.19	0.06-1.60	
160401-FS		●	●		16.3	9.525	4.76	0.1	4.4	0.01-0.16	0.04-1.80		
160402-FS		●	●		16.1	9.525	4.76	0.2	4.4	0.02-0.18	0.05-2.00		
160404-FS		●	●		15.7	9.525	4.76	0.4	4.4	0.04-0.19	0.08-2.00		

● : Stock item

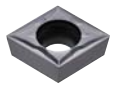
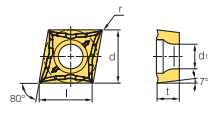
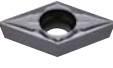
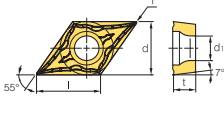

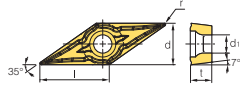

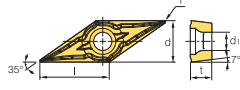
Stock items (MS Chip breaker)

【Ultra-precision insert】

Inserts	Designation	Coated		Uncoated	Dimensions (mm)					Cutting conditions		Geometries
		PC5300	PC8110	H05	l	d	t	r	d ₁	f _n (mm/rev)	a _p (mm)	
Medium cutting (Ultra-precision)	 CCGT 09T301MFN-MS 09T302MFN-MS 09T304MFN-MS	● ●	● ●		9.8	9.525	3.97	<0.1	4.4	0.02-0.23	0.05-2.00	
		● ●	● ●		9.6	9.525	3.97	<0.2	4.4	0.03-0.25	0.07-2.50	
		● ●	● ●		9.2	9.525	3.97	<0.4	4.4	0.05-0.25	0.09-2.50	
	 DCGT 11T301MFN-MS 11T302MFN-MS 11T304MFN-MS	● ●	● ●		11.4	9.525	3.97	<0.1	4.4	0.02-0.23	0.05-2.00	
		● ●	● ●		11.2	9.525	3.97	<0.2	4.4	0.03-0.25	0.07-2.50	
		● ●	● ●		11.0	9.525	3.97	<0.4	4.4	0.05-0.25	0.09-2.50	
	 VCGT 110301MFN-MS 110302MFN-MS 110304MFN-MS	● ●	● ●		10.8	6.35	3.18	<0.1	2.8	0.02-0.23	0.05-2.00	
		● ●	● ●		10.6	6.35	3.18	<0.2	2.8	0.03-0.25	0.07-2.50	
		● ●	● ●		11.4	6.35	3.18	<0.4	2.8	0.05-0.25	0.09-2.50	
	 VCGT 1203008FN-MS 120301FN-MS 120302FN-MS 120304FN-MS	● ●	● ●		12.2	7.50	3.00	0.08	2.8	0.02-0.20	0.04-1.80	
		● ●	● ●		12.6	7.50	3.00	0.1	2.8	0.03-0.26	0.06-2.20	
		● ●	● ●		12.8	7.50	3.00	0.2	2.8	0.05-0.28	0.08-2.80	
● ●		● ●	12.9		7.50	3.00	0.4	2.8	0.06-0.30	0.10-2.80		

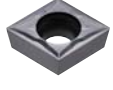
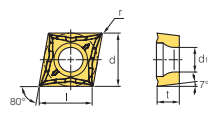
● : Stock item

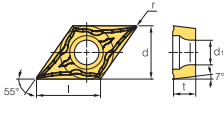
【High precision insert】

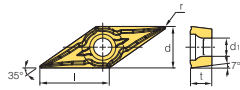
Inserts	Designation	Coated		Uncoated	Dimensions (mm)					Cutting conditions		Geometries
		PC5300	PC8110	H05	l	d	t	r	d ₁	f _n (mm/rev)	a _p (mm)	
Medium cutting (High precision)	 CCGT 09T301-MS 09T302-MS 09T304-MS	● ●	● ●		9.8	9.525	3.97	0.1	4.4	0.02-0.23	0.05-2.00	
		● ●	● ●		9.6	9.525	3.97	0.2	4.4	0.03-0.25	0.07-2.50	
		● ●	● ●		9.2	9.525	3.97	0.4	4.4	0.05-0.25	0.09-2.50	
	 DCGT 11T301-MS 11T302-MS 11T304-MS	● ●	● ●		11.4	9.525	3.97	0.1	4.4	0.02-0.23	0.05-2.00	
		● ●	● ●		11.2	9.525	3.97	0.2	4.4	0.03-0.25	0.07-2.50	
		● ●	● ●		11.0	9.525	3.97	0.4	4.4	0.05-0.25	0.09-2.50	
	 VCGT 110301-MS 110302-MS 110304-MS	● ●	● ●		10.8	6.35	3.18	0.1	2.8	0.02-0.23	0.05-2.00	
		● ●	● ●		10.6	6.35	3.18	0.2	2.8	0.03-0.25	0.07-2.50	
		● ●	● ●		11.4	6.35	3.18	0.4	2.8	0.05-0.25	0.09-2.50	

● : Stock item

Auto Tools (KHP Coolant)

Code system

【Holder】



S	C	L	C	R/L	12	12	-	X	09	A	-	KHP
Clamping method of insert S: Screw on system	Holder style L: 95° J: 93°		Clearance angle of insert C: 7°	Hand R: Right L: Left	Width of shank 12 mm	Height of shank 12 mm		Length of holder X: 120 mm	Length of insert cutting 07, 09, 11, 12	Auto Tools		KORLOY High Pressure coolant
	Insert shape C: C type D: D type V: V type											

Features

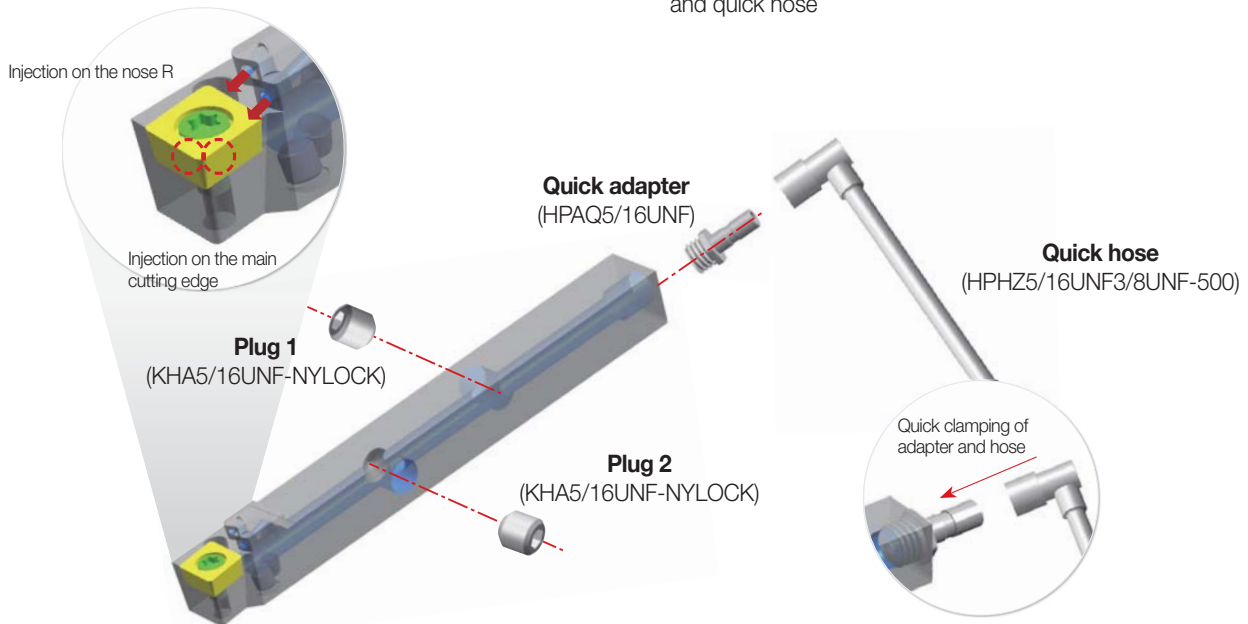
- Coolant holder for high productivity in automatic lathe machining
- Increased cooling and chip control due to concentrated injection on the main cutting edge and nose R with injecting coolant through 2 holes
- Turning solution for high productivity and better chip control in Titanium machining
- Increased chip control from 2 coolant holes with different injecting angles
- Convenience due to quick clamping of quick hose adapter and quick hose

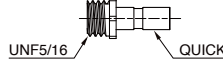

Parts

	Shape	Geometries	Length	Q clamping dimensions	S clamping dimensions
Quick to straight	HPHZ5/16UNF3/8UNF-500 		500 mm	UNF5/16	-
Quick adapter	HPAQ5/16UNF 		18.5 mm	UNF5/16	

SCLCR/L

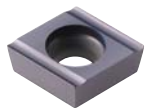

CC□T

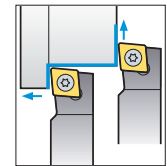
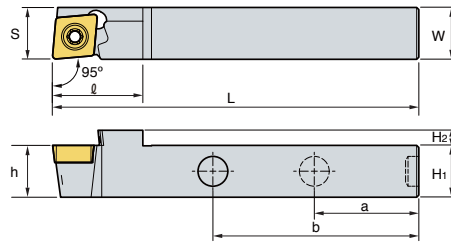

95°

• R type insert
(mm)

Designation	Stock		H ₁	H ₂	W	L	S	h	ℓ	a	b	Insert	Screw	Plug	Wrench
	R	L													
SCLCR/L 1212-X09A-KHP	●	●	12	3.5	12	120	12	12	21	40	70	CC□T09T3□□	FTKA0410	KHA0404-NYLOCK	TW15P

● : Stock item

SDJCR/L

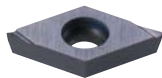

DC□T

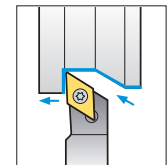
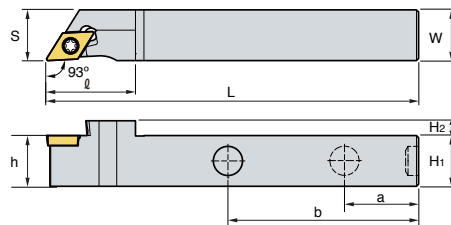

93°

• R type insert
(mm)

Designation	Stock		H ₁	H ₂	W	L	S	h	ℓ	a	b	Insert	Screw	Plug	Wrench
	R	L													
SDJCR/L 1212-X07A-KHP	●	●	12	3.5	12	120	12	12	21	40	70	DC□T0702□□	FTKA02565	KHA0404-NYLOCK	TW07P
1212-X11A-KHP	●	●	12	3.5	12	120	14	12	29.8	40	70	DC□T11T3□□	FTKA0408	KHA0404-NYLOCK	TW15P

● : Stock item

SVJCR/L

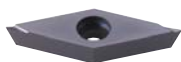

VC□T

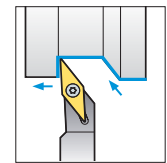
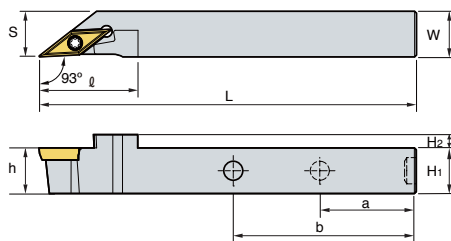

93°

• R type insert
(mm)

Designation	Stock		H ₁	H ₂	W	L	S	h	ℓ	a	b	Insert	Screw	Plug	Wrench
	R	L													
SVJCR/L 1212-X11A-KHP	●	●	12	3.5	12	120	12	12	26	40	70	VC□T1103□□	FTKA02565	KHA0404-NYLOCK	TW07P
1212-X12A-KHP	●	●	12	3.5	12	120	12	12	26	40	70	VC□□1203□□	FTKA02565	KHA0404-NYLOCK	TW07P

● : Stock item

www.korloy.com



Holystar B/D, 1350, Nambusunhwan-ro, Geumcheon-gu, Seoul, 08536, Korea
Tel : +82-2-522-3181 Fax : +82-2-522-3184, +82-2-3474-4744 Web : www.korloy.com E-mail : sales.khq@korloy.com

KORLOY AMERICA

620 Maple Avenue, Torrance, CA 90503, USA
Tel : +1-310-782-3800 Toll Free : +1-888-711-0001 Fax : +1-310-782-3885
E-mail : sales.kai@korloy.com

KORLOY INDIA

Plot No. 415, Sector 8, IMT Manesar, Gurgaon 122051, Haryana, India
Tel : +91-124-4391790 Fax : +91-124-4050032
E-mail : sales.kip@korloy.com

KORLOY TURKEY

Orucreis Mah. Vadi Cad. No: 108 Istanbul Ticaret Sarayi
Kat 5 No: 318 Giyimkent Sitesi-Esenler/Istanbul, Turkey
Tel : +90-212-438-5197 E-mail : sales.ktl@korloy.com

KORLOY RUSSIA

Krasivy Dom office No. 305, Bld. 5, Novovladykinskiy proezd 8, 127106,
Moscow, Russia
Tel : +7-495-280-1458 Fax : +7-495-280-1459 E-mail : sales.krc@korloy.com

KORLOY FACTORY QINGDAO

Ground Dongjing Road 56(B) District Free Trade Zone. Qingdao, China
Tel : +86-532-86959880 Fax : +86-532-86760651
E-mail : pro.ktq@korloy.com

KORLOY EUROPE

Gablonzer Str. 25-27, 61440 Oberursel, Germany
Tel : +49-6171-277-83-0 Fax : +49-6171-277-83-59
E-mail : sales.keg@korloy.com

KORLOY BRASIL

Av. Aruana 280, conj.12, WLC, Alphaville, Barueri,
CEP06460-010, SP, Brasil
Tel : +55-11-4193-3810 E-mail : sales.kbl@korloy.com

KORLOY CHILE

Av. Providencia 1650, Office 1009, 7500027
Providencia-Santiago, Chile
Tel : +56-229-295-490 E-mail : sales.kcs@korloy.com

KORLOY MEXICO

Queretaro, Mexico
E-mail : sales.kml@korloy.com

KORLOY FACTORY INDIA

Plot No. 415, Sector 8, IMT Manesar, Gurgaon 122051, Haryana, India
Tel : +91-124-4391790 Fax : +91-124-4050032
E-mail : pro.kim@korloy.com