

SANYO**LA4620****Two-channel Audio Power Amplifier****Overview**

The LA4620 is a two-channel high-power audio amplifier for automotive stereo and general-purpose audio amplification equipment.

The LA4620 has a 6 to 22V operating supply voltage range. Each channel uses a bridge configuration to obtain high output power from low supply voltages. Typical output power is 17W per channel.

The LA4620 incorporates a thermal protection circuit, an output short-circuit protection circuit and a pop suppression circuit. It has low-power, logic-level standby control and mute control inputs.

The LA4620 is available in 23-pin SIPs and operates from a 15V supply.

Features

- 17W output power per channel.
- 6 to 22V supply voltage range.
- Pop suppression.
- Logic-controlled standby mode.
- Thermal protection.
- Short-circuit protection.
- 60dB channel separation.
- 58dB supply voltage ripple rejection.
- 0.2% harmonic distortion.
- 23-pin SIP.

Package Dimensions

unit:mm

3160-SIP23HZ

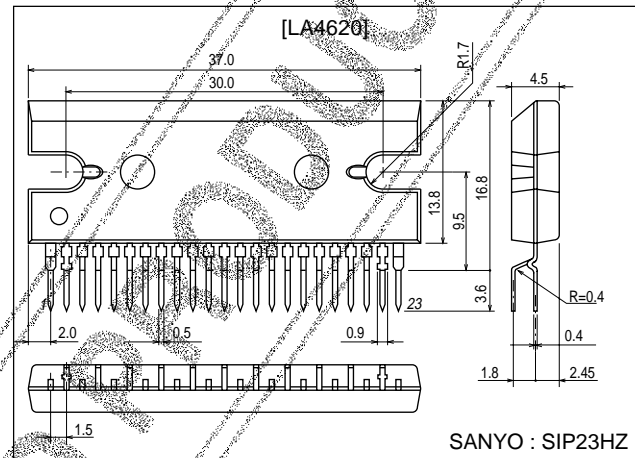

■ Any and all SANYO products described or contained herein do not have specifications that can handle applications that require extremely high levels of reliability, such as life-support systems, aircraft's control systems, or other applications whose failure can be reasonably expected to result in serious physical and/or material damage. Consult with your SANYO representative nearest you before using any SANYO products described or contained herein in such applications.

■ SANYO assumes no responsibility for equipment failures that result from using products at values that exceed, even momentarily, rated values (such as maximum ratings, operating condition ranges, or other parameters) listed in products specifications of any and all SANYO products described or contained herein.

SANYO Electric Co.,Ltd. Semiconductor Company

TOKYO OFFICE Tokyo Bldg., 1-10, 1 Chome, Ueno, Taito-ku, TOKYO, 110-8534 JAPAN

Specifications

Maximum Ratings at $T_a = 25^\circ\text{C}$

Parameter	Symbol	Conditions	Ratings	Unit
Supply voltage	V_{CC} max		24	V
Allowable power dissipation	P_d max		37.5	W
Operating temperature	T_{opr}		-20 to +75	$^\circ\text{C}$
Storage temperature	T_{stg}		-40 to +150	$^\circ\text{C}$

Recommended Operating Conditions at $T_a = 25^\circ\text{C}$

Parameter	Symbol	Conditions	Ratings	Unit
Supply voltage	V_{CC}		12, 15	V
Supply voltage range	V_{CC}		6 to 22	V
Load resistance	R_L		4	Ω

Note

When operating at 22V with a load of 4Ω , ensure that the output power, P_O , does not exceed 1W per channel.

Electrical Characteristics at $T_a = 25^\circ\text{C}$, $V_{CC}=15\text{V}$, $f=1\text{kHz}$, $R_L=4\text{k}\Omega$, $R_g=600\Omega$ unless otherwise noted

Parameter	Symbol	Conditions	Ratings			Unit
			min	typ	max	
Quiescent current	I_{CCO}		50	75	120	mA
Standby current	I_{ST}			1	10	μA
Output power	P_{O1}	$V_{CC}=12\text{V}$, THD=10%	10	13		W
	P_{O2}	$V_{CC}=15\text{V}$, THD=10%	14	17		W
Total harmonic distortion	THD	$P_O=1\text{W}$		0.2	1.0	%
Input resistance	R_{IN}		17	24	31	$\text{k}\Omega$
Voltage gain	VG		42	44	46	dB
Output noise voltage	V_{NO1}	$R_g=0\Omega$, bandpass frequency range=20Hz to 20kHz		0.2	0.5	mV
	V_{NO2}	$R_g=10\text{k}\Omega$, bandpass frequency range=20Hz to 20kHz		0.5	1.0	mV
Channel separation	CH SEP	$R_g=10\text{k}\Omega$, $V_O=0\text{dBm}$	45	60		dB
Supply voltage ripple rejection	SVRR	$R_g=0\Omega$, $f_r=100\text{Hz}$, $V_{CCR}=0\text{dBm}$	45	58		dB
Offset voltage	VOS	$R_g=0\Omega$	-180		+180	mV

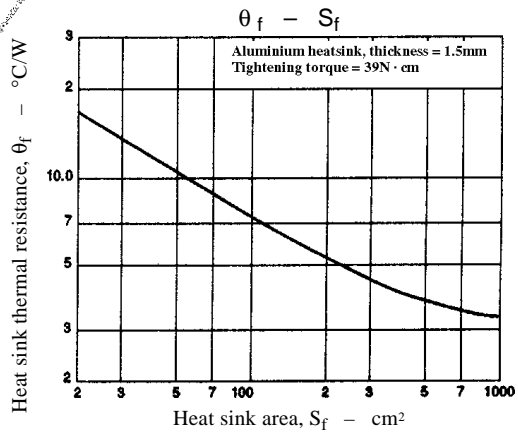
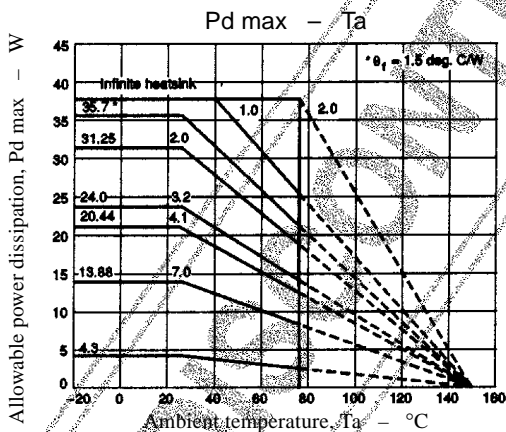

Test Circuit

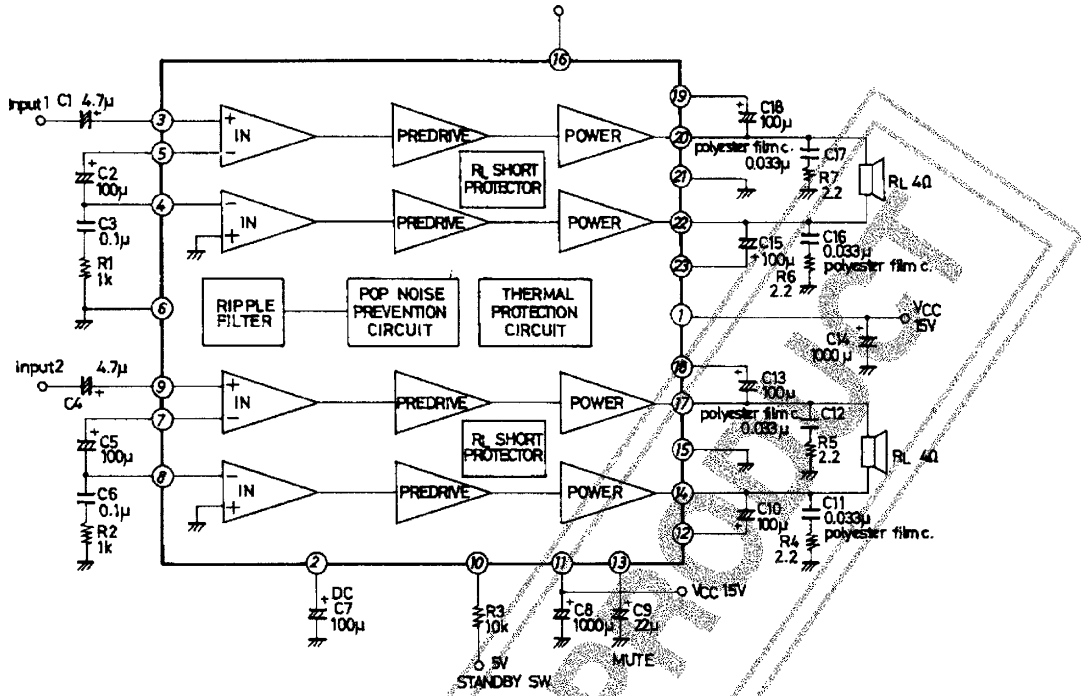

Pin Description

Number	Name	Description
1	VCC	Supply voltage
2	RIP	Ripple filter
3	INPUT1	Channel 1 input
4	NF2	Channel 1 negative feedback input
5	NF1	Channel 1 negative feedback input
6	GND	Ground
7	NF3	Channel 2 negative feedback input
8	NF4	Channel 2 negative feedback input
9	INPUT2	Channel 2 input
10	STANDBY	Standby switch
11	VCC	Supply voltage
12	BS4	Channel 2 bootstrap capacitor
13	MUTE	Muting control
14	OUT4	Channel 2 output
15	GND	Ground
16	NC	No connection
17	OUT3	Channel 2 output
18	BS3	Channel 2 bootstrap capacitor
19	BS1	Channel 1 bootstrap capacitor
20	OUT1	Channel 1 output
21	GND	Ground
22	OUT2	Channel 1 output
23	BS2	Channel 1 bootstrap capacitor

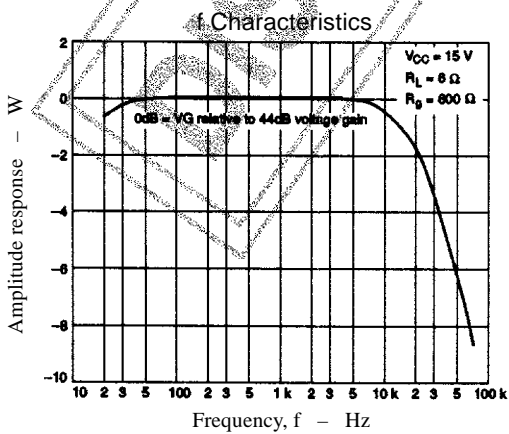
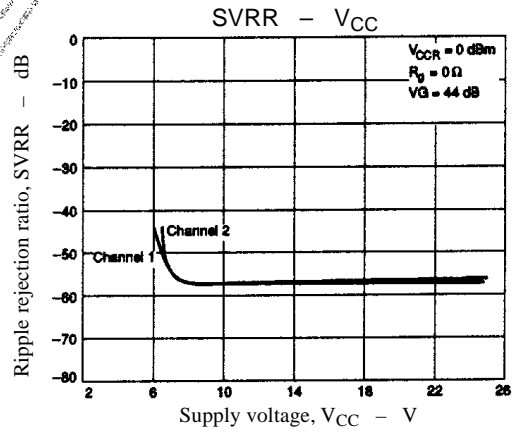
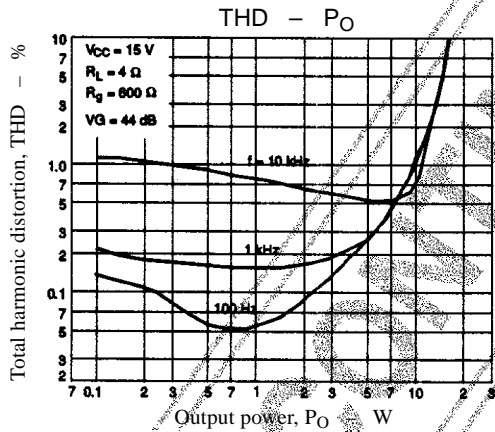
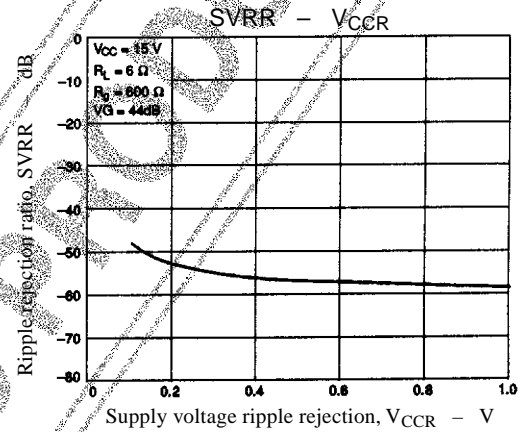
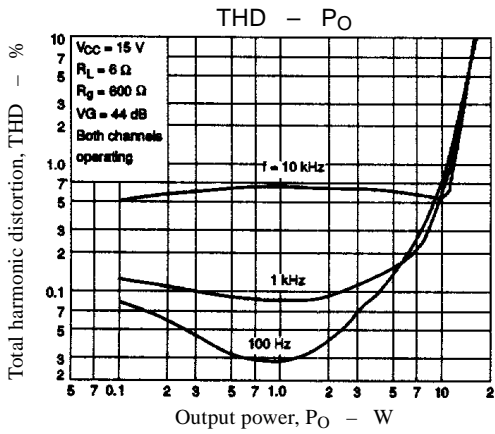
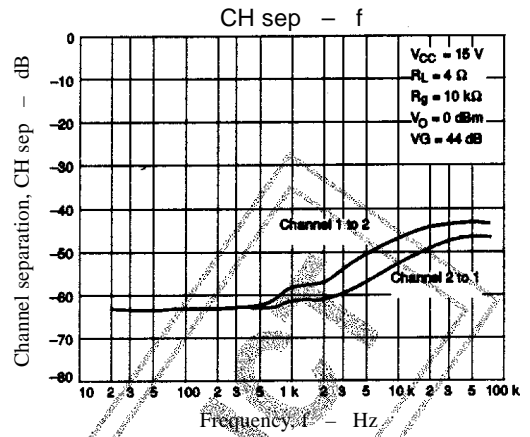
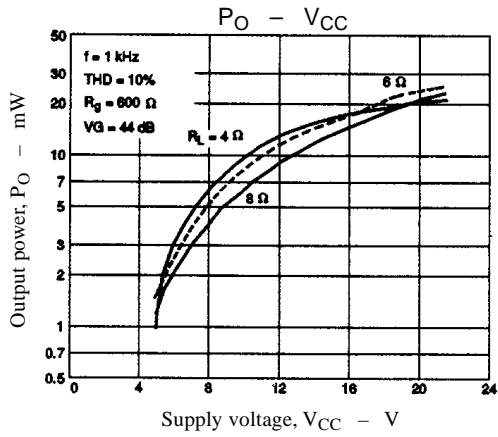

LA4620

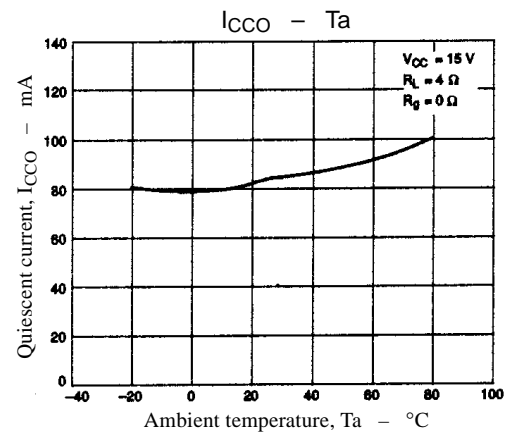
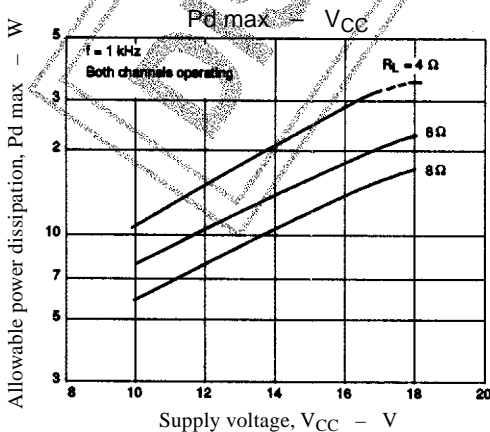
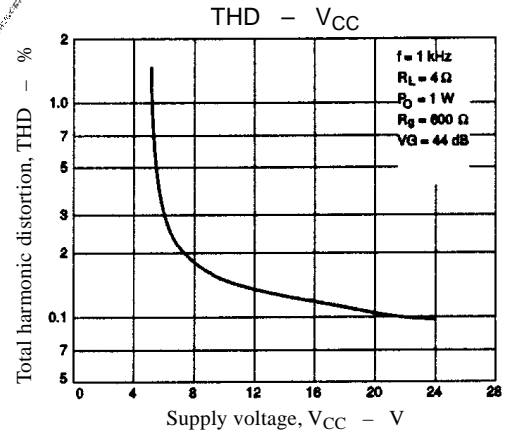
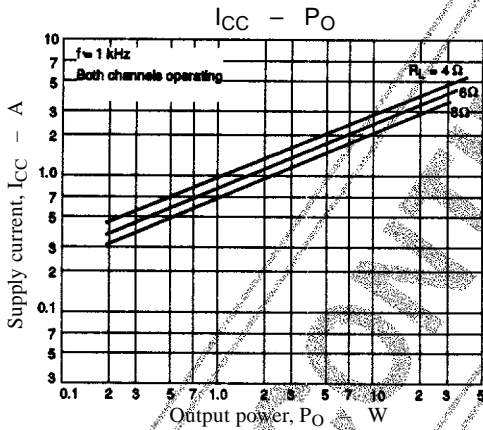
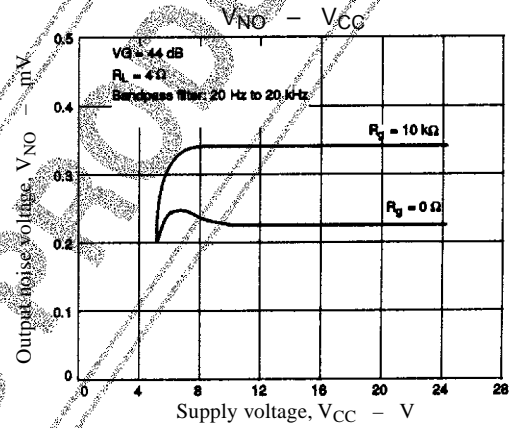
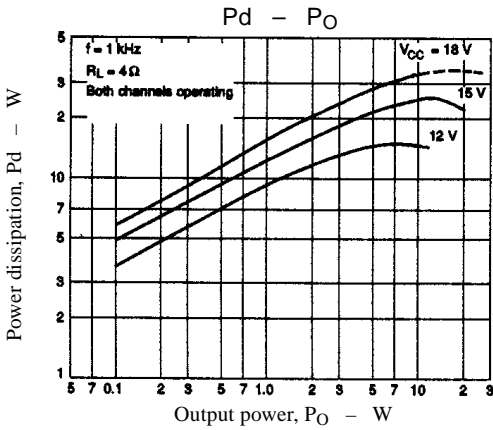
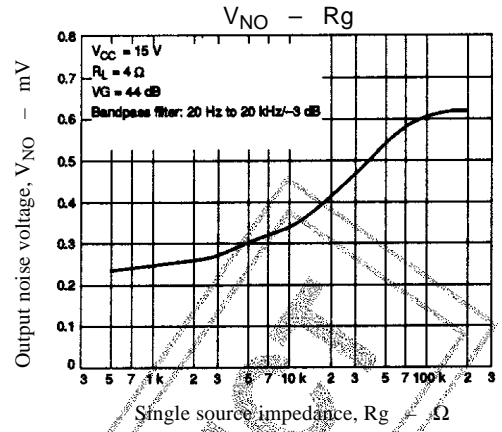
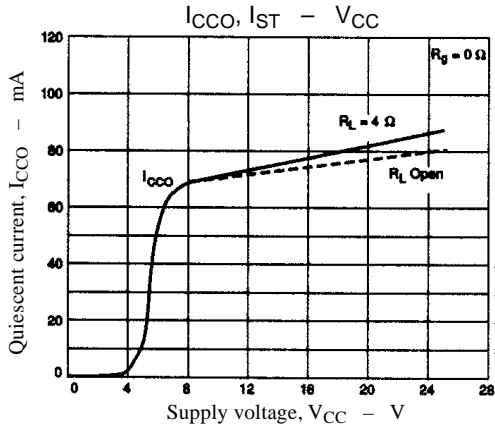

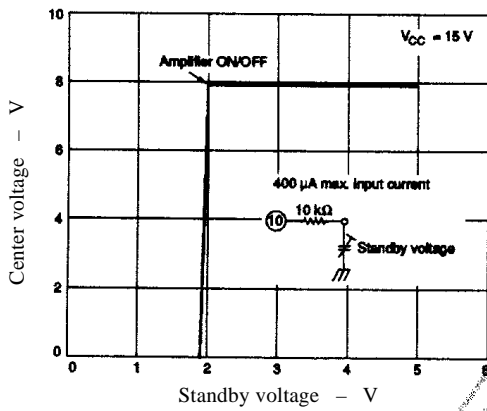
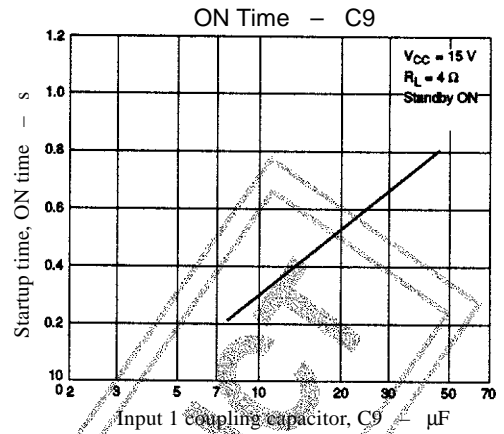
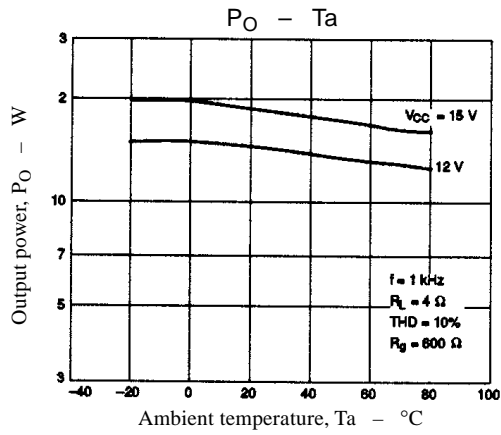

Functional Description

Standby Mode Control

Applying 1.5V or more to R3 at STANDBY SW enables the amplifier. The maximum input current is 400 μA .

Mute Control

Pulling MUTE to ground mutes the amplifier. The startup time and recovery time when MUTE is pulled HIGH can be adjusted by changing C_9 .

Short-circuit Protection

The LA4620 incorporates a protection circuit for short circuits between output pins. However, this is inadequate for short circuits to ground or the supply. See the design notes.

Sample Printed Circuit Pattern

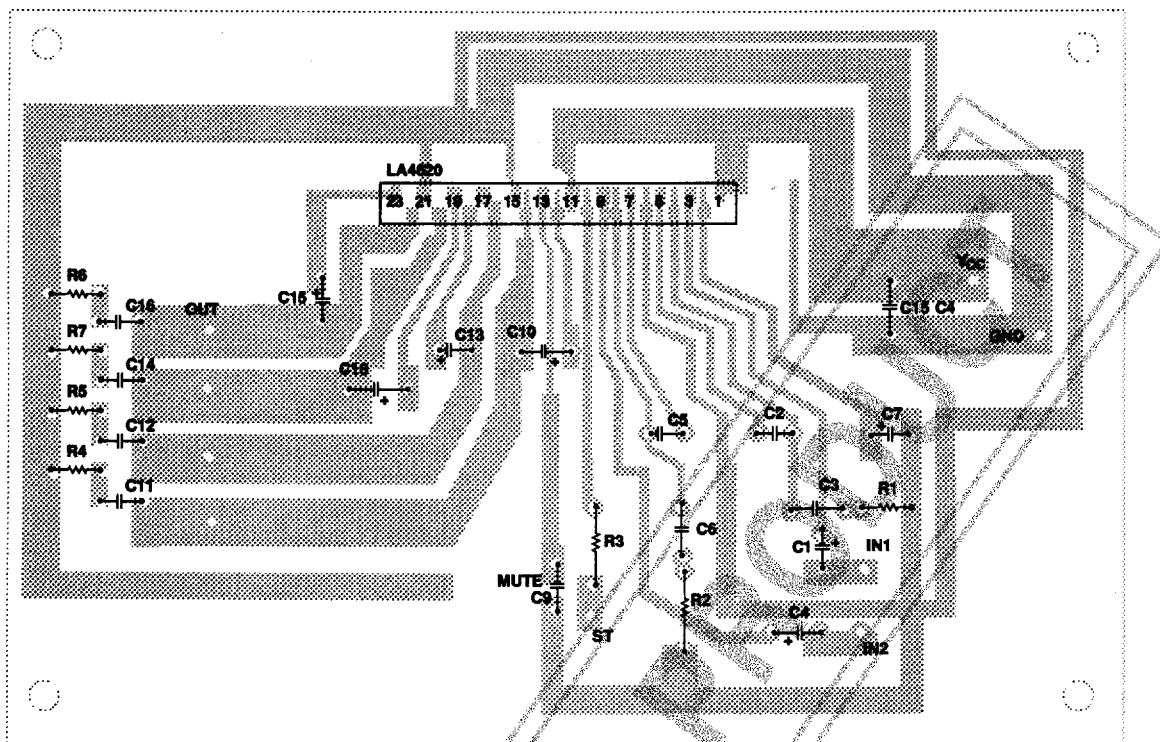

Note

Board size : 125 × 85mm
 Surface finish : Copper foil

Design Notes

Input Capacitors

C1 and C4 are input coupling capacitors. They should both be 4.7 μ F or less.

Feedback Capacitors

C2 and C5 from the negative feedback network. They could both be between 47 and 100 μ F.

Supply Decoupling Capacitor

C7 should be 100 μ F.

Supply Ripple Filter Capacitors

C8 and C14 smooth the supply voltage. Both should be at least 1,000 μ F, and one of at least 2,000 μ F can be used.

Startup Time Capacitor

C9 determines the amplifier startup time.

Bootstrapping Capacitors

C10, C13, C15 and C18 improve the device linearity for a wide range of input signals. These capacitors should be between 47 μ F and 100 μ F to improve the low-frequency response.

Oscillation Suppression

The R1 and C3, and R2 and C6 networks suppress oscillation. Use ceramic or mylar capacitors of 0.1 μ F or more. Avoid using very large capacitances as these can cause high-frequency distortion.

C11, C12, C16, and C17 from RC networks with R4, R5, R6 and R7, respectively. Use mylar capacitors of 33nF or more to prevent instability caused by circuit board layout.

Standby Control Current Limiting Resistor

R3 limits the current applied to STANDBY SW. It should be 10 Ω or more.

Heatsinking

The LA4620 should always be operated with a heatsink. If the heatsink does not provide adequate thermal dissipation, the thermal protection circuit will attenuate the signal level when the device overheats to prevent long-term thermal stress.

Short-circuit Protection

If outputs can be shorted either to ground or the supply, use an external circuit to protect the device as shown in the following figure.

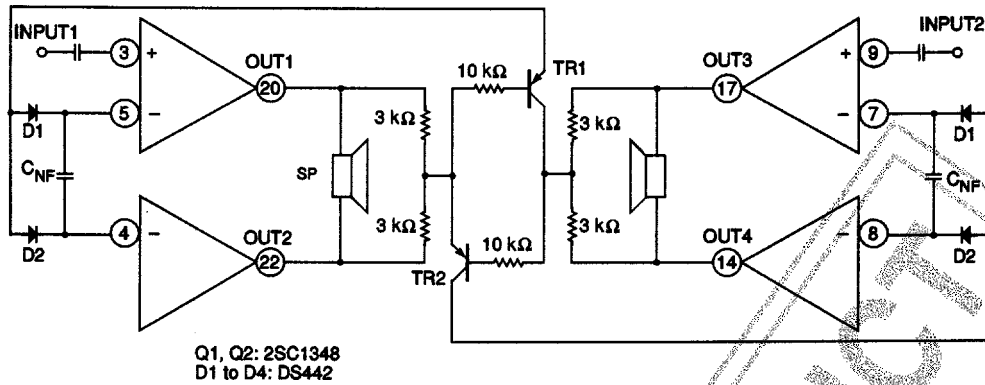

- Specifications of any and all SANYO products described or contained herein stipulate the performance, characteristics, and functions of the described products in the independent state, and are not guarantees of the performance, characteristics, and functions of the described products as mounted in the customer's products or equipment. To verify symptoms and states that cannot be evaluated in an independent device, the customer should always evaluate and test devices mounted in the customer's products or equipment.
- SANYO Electric Co., Ltd. strives to supply high-quality high-reliability products. However, any and all semiconductor products fail with some probability. It is possible that these probabilistic failures could give rise to accidents or events that could endanger human lives, that could give rise to smoke or fire, or that could cause damage to other property. When designing equipment, adopt safety measures so that these kinds of accidents or events cannot occur. Such measures include but are not limited to protective circuits and error prevention circuits for safe design, redundant design, and structural design.
- In the event that any or all SANYO products (including technical data, services) described or contained herein are controlled under any of applicable local export control laws and regulations, such products must not be exported without obtaining the export license from the authorities concerned in accordance with the above law.
- No part of this publication may be reproduced or transmitted in any form or by any means, electronic or mechanical, including photocopying and recording, or any information storage or retrieval system, or otherwise, without the prior written permission of SANYO Electric Co., Ltd.
- Any and all information described or contained herein are subject to change without notice due to product/technology improvement, etc. When designing equipment, refer to the "Delivery Specification" for the SANYO product that you intend to use.
- Information (including circuit diagrams and circuit parameters) herein is for example only; it is not guaranteed for volume production. SANYO believes information herein is accurate and reliable, but no guarantees are made or implied regarding its use or any infringements of intellectual property rights or other rights of third parties.

This catalog provides information as of April, 2000. Specifications and information herein are subject to change without notice.