

**DC MOTOR SPEED CONTROLLER**

The KA2404 is a monolithic integrated circuit designed for DC motor speed controllers.

**FEATURES**

- Suitable for DC motor speed controllers of cassette tape recorders and radio cassettes.
- Excellent stability of each characteristics against ambient temperature.
- High output current.
- Low quiescent current (1.3mA: typ).
- Low reference voltage.
- Wide operating supply voltage range ( $V_{CC} = 4V \sim 12V$ )
- KA2404A: TO-126 PKG type

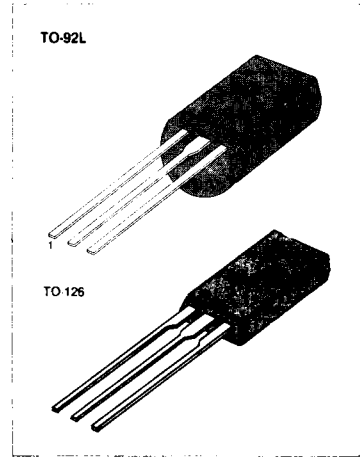

3

**EQUIVALENT CIRCUIT BLOCK DIAGRAM**

**ORDERING INFORMATION**

Device	Package	Operating Temperature
KA2404	TO-92L	-20°C ~ +70°C
KA2404A	TO-126	

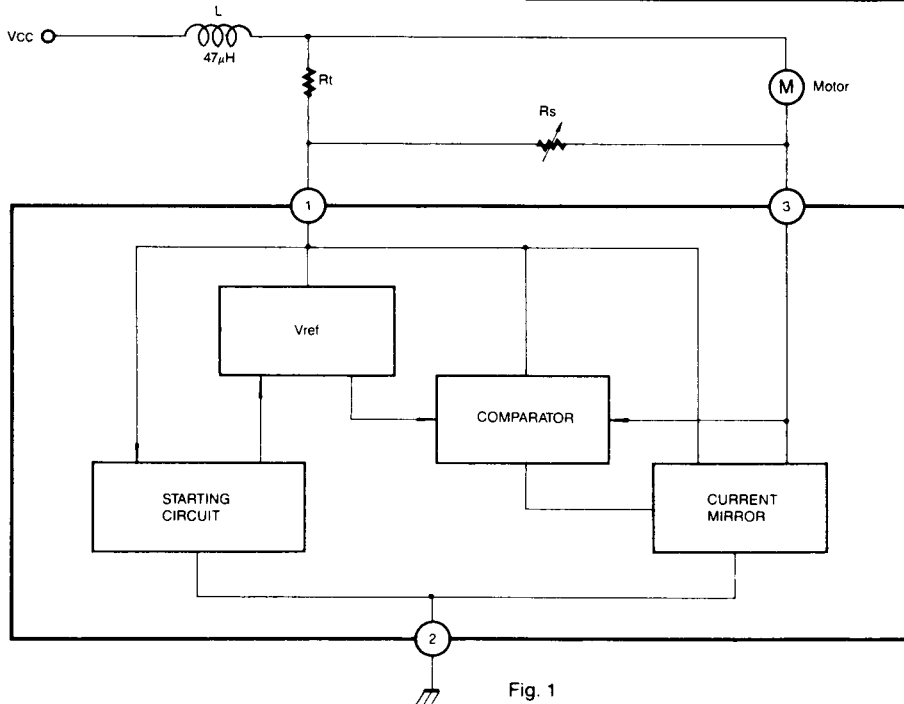

Fig. 1

## ABSOLUTE MAXIMUM RATINGS (Ta = 25°C)

Characteristics	Symbol	Value	Unit
Supply Voltage	V <sub>CC</sub>	16	V
Circuit Current	I <sub>3</sub>	2 (Note 1)	A
Power Dissipation (TO-126)	P <sub>D</sub> (TO-92L) 1.3 (Note 2)	800 W	mW
Operating Temperature	T <sub>OPR</sub>	-20 ~ +70	°C
Storage Temperature	T <sub>STG</sub>	-40 ~ +125	°C

Note 1: 5 &gt; 5 sec

Note 2: Ta = 25°C, with a 100 × 100mm bakelite printed circuit board (35μ Cu leaf)

## ELECTRICAL CHARACTERISTICS

(Ta = 25°C, V<sub>CC</sub> = 9V, unless otherwise specified)

Characteristic	Symbol	Test Conditions	Min	Typ	Max	Unit	Fig
Reference Voltage	V <sub>REF</sub>	I <sub>3</sub> = 10mA	1.10	1.27	1.40	V	2
Quiescent Circuit Current	I <sub>CCQ</sub>	R <sub>m</sub> = 180Ω	0.8	1.3	1.8	mA	4
Current Coefficient	K	R <sub>m1</sub> = 44Ω R <sub>m2</sub> = 33Ω	16	18	20		3
Voltage Characteristic of Current Coefficient	$\frac{\Delta K}{K} / \Delta V_{CC}$	I <sub>3</sub> = 100mA V <sub>CC</sub> = 4 ~ 12V		0.4		%/V	3
Voltage Characteristic of Reference Voltage	$\frac{\Delta V_{REF}}{V_{REF}} / \Delta V_{CC}$	I <sub>3</sub> = 100mA V <sub>CC</sub> = 4 ~ 12V		0.06		%/V	2
Current Characteristic of Current Coefficient	$\frac{\Delta K}{K} / \Delta I_3$	I <sub>3</sub> = 30 ~ 200mA		-0.02		%/mA	3
Current Characteristic of Reference Voltage	$\frac{\Delta V_{REF}}{V_{REF}} / \Delta I_3$	I <sub>3</sub> = 30 ~ 200mA		-0.02		%/mA	2
Temperature Characteristics of Current Coefficient	$\frac{\Delta K}{K} / \Delta T_a$	I <sub>3</sub> = 100mA T <sub>a</sub> = -20 ~ +75°C		0.01		%/°C	3
Temperature Characteristics of Reference Voltage	$\frac{\Delta V_{REF}}{V_{REF}} / \Delta T_a$	I <sub>3</sub> = 100mA T <sub>a</sub> = -20 ~ +75°C		0.01		%/°C	2

**TEST CIRCUIT 1**  
Reference Voltage

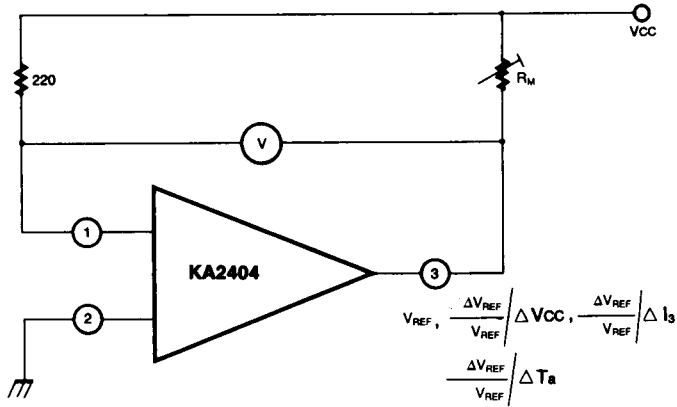

Fig. 2

**TEST CIRCUIT 2**  
Current Coefficient

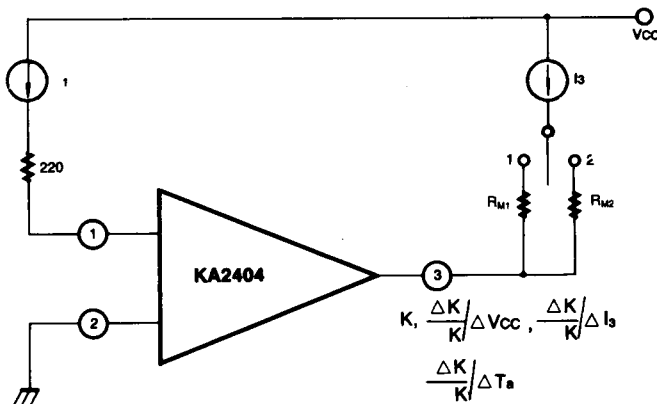

Fig. 3

$$K = \frac{I_s (SW 2) - (SW 1)}{I_1 (SW 2) - (SW 1)}$$

**TEST CIRCUIT 3**

Quiescent Circuit Current

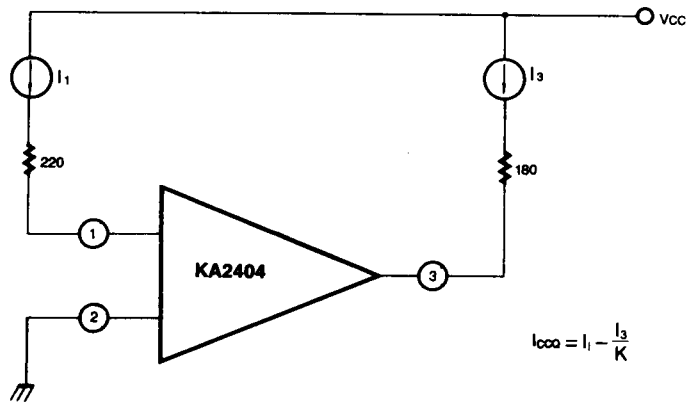
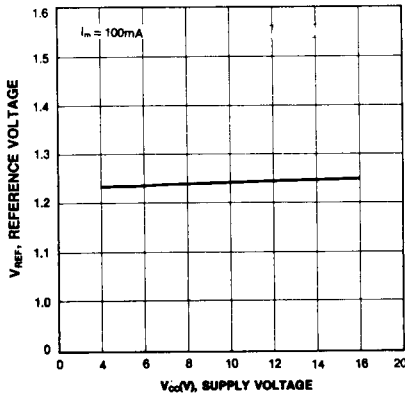
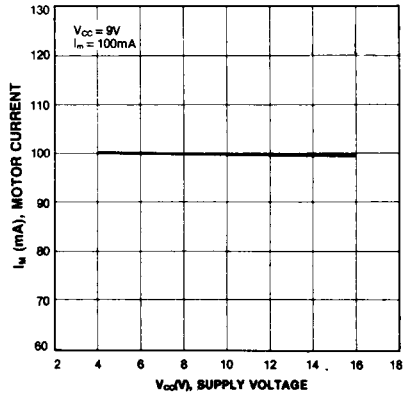

Fig. 4

REFERENCE VOLTAGE-SUPPLY VOLTAGE



MOTOR CURRENT-SUPPLY VOLTAGE



CURRENT COEFFICIENT-SUPPLY VOLTAGE

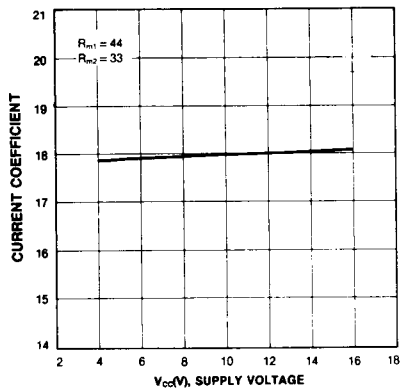

REFERENCE VOLTAGE-MOTOR CURRENT

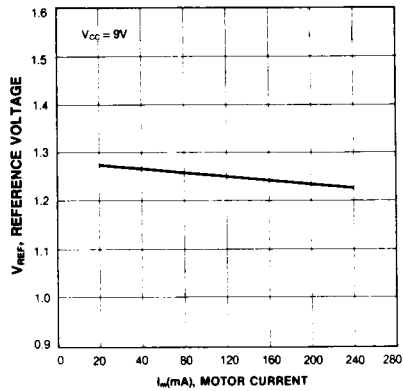

CURRENT COEFFICIENT-AMBIENT TEMPERATURE

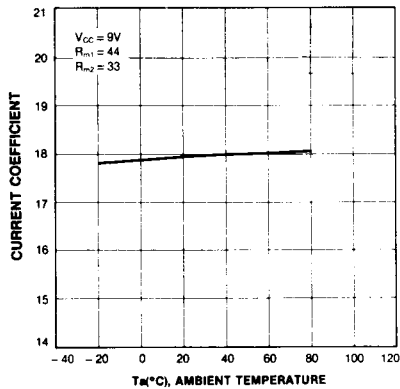

REFERENCE VOLTAGE-AMBIENT TEMPERATURE

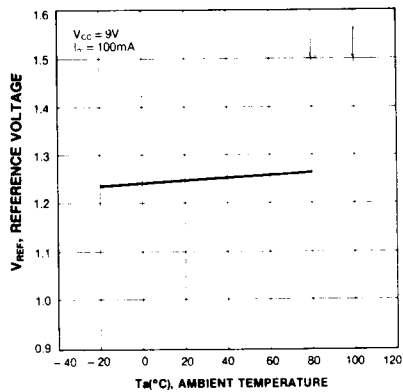

(APPLICATION CHARACTERISTICS)

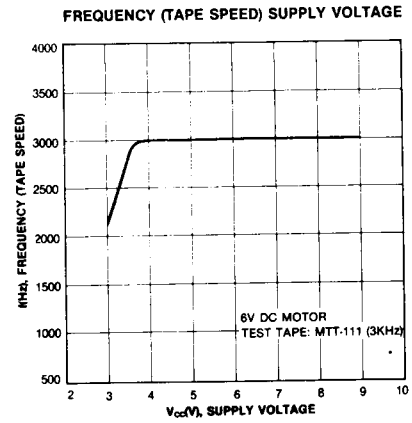
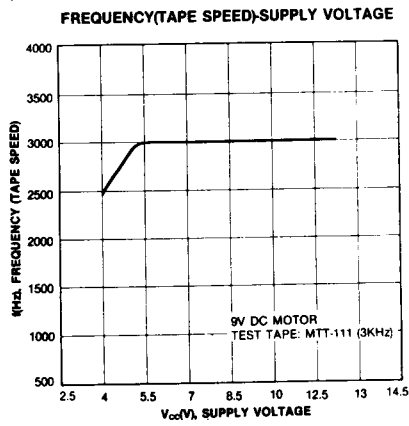

APPLICATION CIRCUIT

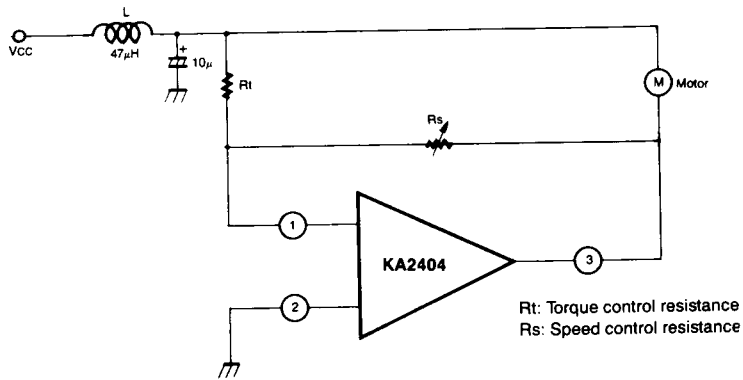

Fig. 5