

APREPARED BY : DATE	 DISPLAY DEVICE BUSINESS GROUP SHARP CORPORATION SPECIFICATION	SPEC No. LD-23Y07B
APPROVED BY : DATE		FILE No.
		ISSUE : Nov. 30. 2011
		PAGE : 21pages
		APPLICABLE GROUP DISPLAY DEVICE BUSINESS GROUP

Revised: Dec.26.2011

DEVICE SPECIFICATION FOR
TFT-LCD Module
 MODEL No.
LQ057Q3DC03

CUSTOMER'S APPROVAL

DATE _____

BY _____

PRESENTED
 BY 

 J.KAWANISHI
 Department General Manager
 Development Dept. I
 DISPLAY DEVICE DIVISION II
 DISPLAY DEVICE BUSINESS GROUP
 SHARP CORPORATION

NOTICE

This publication is the proprietary of SHARP and is copyrighted, with all rights reserved. Under the copyright laws, no part of this publication may be reproduced or transmitted in any form or by any means, electronic or mechanical for any purpose, in whole or in part, without the express written permission of SHARP. Express written permission is also required before any use of this publication may be made by a third party.

The application circuit examples in this publication are provided to explain the representative applications of SHARP's devices and are not intended to guarantee any circuit design or permit any industrial property right or other rights to be executed. SHARP takes no responsibility for any problems related to any industrial property right or a third party resulting from the use of SHARP's devices, except for those resulting directly from device manufacturing processes.

In the absence of confirmation by device specification sheets, SHARP takes no responsibility for any defects that occur in equipment using any of SHARP's devices, shown in catalogs, data books, etc. Contact SHARP in order to obtain the latest device specification sheets before using any SHARP's device.

SHARP reserves the right to make changes in the specifications, characteristics, data, materials, structures and other contents described herein at any time without notice in order to improve design or reliability. Contact SHARP in order to obtain the latest specification sheets before using any SHARP's device. Manufacturing locations are also subject to change without notice.

Observe the following points when using any device in this publication. SHARP takes no responsibility for damage caused by improper use of the devices.

The devices in this publication are designed for general electronic equipment use.

The appropriate design measures should be taken to ensure reliability and safety when SHARP's devices are used for equipment such as:

- Transportation control and safety equipment(i.e.,aircraft, trains, automobiles, etc.)
- Traffic signals • Gas leakage sensor breakers • Alarm equipment • Various safety devices etc.

SHARP's devices shall not be used for equipment that requires extremely high level of reliability, such as:

- Military and space applications • Nuclear power control equipment
- Medical equipment for life support

Contact a SHARP representative, in advance, when intending to use SHARP's devices for any "specific" applications other than those recommended by SHARP.

Contact and consult with a SHARP representative if there are any questions about the contents of this publication.

Table of contents

1	Applicable TFT-LCD module	3
2	Overview	3
3	Mechanical Specifications	3
4	Input Signal Assignment	4
4-1	TFT-LCD Panel driving section	4
4-2	Backlight driving section	5
5	Absolute maximum ratings	5
6	Electrical characteristics	6
6-1	TFT-LCD Panel driving section	6
6-2	Backlight driving section	7
7	Timing Characteristics of input signals	8
7-1	Timing characteristics	8
7-2	Horizontal display position	8
7-3	Vertical display position	8
7-4	Input Data Signals and Display Position on the screen	9
8	Input Signals, Basic Display Colors and Gray Scale of Each Color	11
9	Optical Specification	12
10	Display Qualities	13
11	Handling Precautions	14
12	Reliability Test Items.	15
13	Packing Form	16
14	Marking of product name	16
15	RoHS Directive	17
16	Storage conditions	17
	Fig.5 Packing Form	18
	Fig.6 Outline Dimensions	19

1 Applicable TFT-LCD module

This specification applies to the color TFT-LCD module, LQ057Q3DC03.

2 Overview

This module is a color active matrix LCD module incorporating amorphous silicon TFT (Thin Film Transistor). It is composed of a color TFT-LCD panel, driver IC, power supply circuit and a back light unit.

Graphics and texts can be displayed on a $320 \times 240 \times \text{RGB}$ dots panel with 262,144 colors by using 18bit digital signal interface (RGB×6bit), four timing signals, and supplying +3.3V DC supply voltage for TFT-LCD panel driving and supply voltage for backlight.

Optimum viewing direction is 12 o'clock.

Backlight-driving LED controller is built in this module.

3 Mechanical Specifications

Table 3.1

Items	Specifications	Unit
Display size (Diagonal)	14.4 (5.7")	cm
Active display area	115.2 (H) x 86.4 (V)	mm
Pixel format	320(H) x 240(V) x RGB	dot
	(1 pixel=R+G+B dots)	-
Aspect ratio	4:3	
Pixel pitch	0.360[H] x 0.360[V]	mm
Pixel configuration	R,G,B Horizontal Stripe configuration	-
LCD mode	Normally white	-
Surface treatment	Glare and hard-coating 2H	-
Dimension*	144.0(W) x 104.6(H) x 12.3(D)	mm
Mass	Max.210	g

[Note3-1] Fig.6 shows dimensions of the module.

4 Input Signal Assignment

4-1. TFT-LCD Panel driving section

CN1 Using connector : FH12-33S-0.5SH(55) (HIROSE ELECTRIC CO., LTD.) Terminal : Gold plated

Table 4.1

Pin No.	Symbol	Function	Remark
1	GND	GND	
2	CK	Dot-clock signal	
3	HSYNC	Horizontal synchronous signal	Negative
4	VSYNC	Vertical synchronous signal	Negative
5	GND	GND	
6	R0	RED data signal(LSB)	
7	R1	RED data signal	
8	R2	RED data signal	
9	R3	RED data signal	
10	R4	RED data signal	
11	R5	RED data signal(MSB)	
12	GND	GND	
13	G0	GREEN data signal(LSB)	
14	G1	GREEN data signal	
15	G2	GREEN data signal	
16	G3	GREEN data signal	
17	G4	GREEN data signal	
18	G5	GREEN data signal(MSB)	
19	GND	GND	
20	B0	BLUE data signal(LSB)	
21	B1	BLUE data signal	
22	B2	BLUE data signal	
23	B3	BLUE data signal	
24	B4	BLUE data signal	
25	B5	BLUE data signal(MSB)	
26	GND	GND	
27	ENAB	Data enable signal (signal to settle the horizontal display position)	Positive
28	VCC	+3.3V power supply	
29	VCC	+3.3V power supply	
30	RL/UD	Selection signal for horizontal/vertical scanning direction ("L" : Normally , "H" : Right-and-Left reversal/Up-and-Down reversal)	[Note4-2]
31	NC	No Connect	
32	SHUT	No Connect (SHUT) (Please be sure to connect 32pin with GND)	
33	GND	GND	

[Note 4-1] Please use a compliant FFC/FPC with the input connector.
The terminal of FFC/FPC is recommended gold plated

(The whisker generation between a FPC and a connector and performance degradation caused by whisker is not covered under warranty)

[Note 4-2]

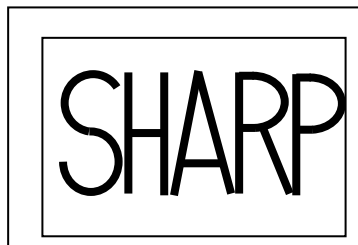

RL/UD = L

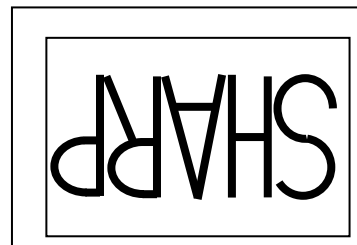

RL/UD = H

4-2 Backlight driving section

CN2

Using connector: SM06B-SRSS-TB(LS)(SN) (JST Mfg. Co., Ltd.) or equivalent.

Corresponding connector: SHR-06V-S-B or SHR-06V-S (JST Mfg. Co., Ltd.)

(Sharp is not responsible to its product quality, if the user applies a connector not corresponding to the above model.)

Pin No.	Symbol	Function	Remark
1	V _{DD}	+12.0V power supply	
2	V _{DD}	+12.0V power supply	
3	GND	GND	
4	GND	GND	
5	PWM	Brightness Adjust (PWM)	
6	V _{st}	LED Open	normal:5V, open error:0V

5 Absolute maximum ratings

Table 5-1

Parameter	Symbol	Condition	Ratings		Unit	Remark
			Min.	Max.		
+3.3V supply voltage	V _{CC}	Ta=25	0	+4.0	V	
+12V supply voltage	V _{DD}	Ta=25	0	+15	V	
Input voltage	V _{IN1}	Ta=25	-0.3	V _{CC} +0.3	V	[Note 5-1]
Input voltage	V _{IN2}	Ta=25	-0.3	V _{DD}	V	[Note 5-2]
Storage temperature	T _{stg}	-	-30	+80		[Note5-3,4,5,6]
Operating temperature	T _{opp}	-	-30	+80		

[Note 5- 1] CK, R0 ~ R5, G0 ~ G5, B0 ~ B5, Hsync, Vsync, ENAB, RL/UD

[Note 5- 2] PWM

[Note5- 3] Humidity:95%RH Max(Ta 40)

Maximum wet-bulb temperature is less than 39 .(Ta>40)

Dew condensation must be avoided as electrical current leaks will occur, causing a degradation of performance specifications.

[Note5- 4] The operating temperature guarantees only operation of the circuit. For contrast, response time and other factors related to display quality, judgment is done using the ambient temperature Ta = + 25 .

[Note5- 5] Take care not to overrun ratings above.

[Note5- 6] In the operating temperature item, the low temperature side is the ambient temperature regulations. The high temperature side is the panel surface(Active Area) temperature regulations.

6 Electrical characteristics

6-1. TFT-LCD Panel driving section

Ta=25°C

Table 6-1

Parameter	Symbol	Min.	Typ.	Max.	Unit	Remarks
Supply voltage	V _{CC}	+3.0	+3.3	+3.6	V	[Note6-1, 4]
Current dissipation	I _{CC}	-	10	30	mA	V _{CC} =3.3V [Note6-5]
Permissible input ripple	V _{pp}	-	-	100	mVp-p	V _{CC} =+3.3V
Input voltage (“Low” state)	V _{IL}	0	-	0.3 × V _{CC}	V	[Note6-6]
Input voltage (“High” state)	V _{IH}	0.7 × V _{CC}	-	V _{CC}	V	
Input leakage current (High)	I _{OH1}	-	-	1	μA	V _I =3.3V [Note6-6]
	I _{OH2}	-	-	400	μA	V _I =3.3V [Note6-7]
Input leakage current(low)	I _{OL}	-1	-	-	μA	V _I =0V [Note6-6] [Note6-7]

[Note6-1] On-off conditions for supply voltage

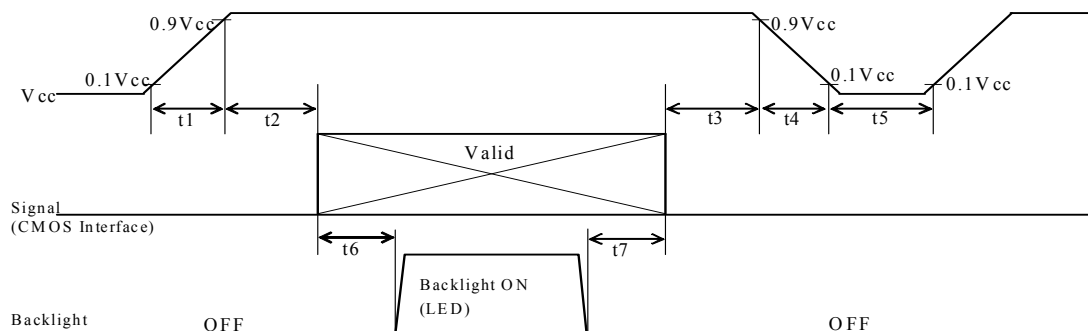

Symbol	Min.	Max.	Unit	Remarks
t1	0	10	ms	
t2	0	100	ms	
t3	0	100	ms	
t4	0	100	ms	
t5	1	-	s	
t6	10	-	frame	[Note 6-2]
t7	3	-	frame	[Note 6-2]

[Note 6- 2] It is recommended to consider some timing difference between CMOS input and Backlight input as shown above.

If the Backlight lights on before LCD starting, or if the Backlight is kept on after LCD stopping, the screen may be projected white for a moment or abnormal image may be displayed. This is caused by variation in output signal from timing generator at CMOS input on or off. It does not cause the damage to the LCD module.

[Note 6- 3] Every Signal is CMOS Input, Hi-Z is prohibited when VCC is on level.

[Note 6- 4] Vcc-dip conditions

- At 2.5V ≤ V_{CC} < 3.0V
t_d ≤ 10 ms
- At V_{CC} < 2.5V
V_{CC} dip conditions should also follow the V_{CC} turn-on/off conditions

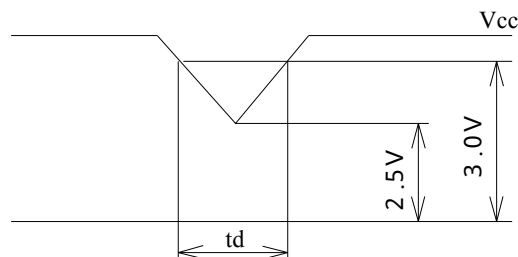

[Note 6-5] Typical current situation :

16-gray-bar pattern.

V_{cc}=+3.3V

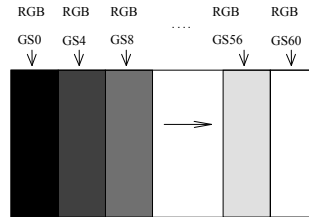

[Note 6-6] CK , R0 ~ R5 , G0 ~ G5 , B0 ~ B5 , Hsync , Vsync , ENAB

[Note 6-7] RL/UD

6-2 Backlight driving section

The backlight system is an edge-lighting type with white-LED.

(It is usually required to measure under the following condition.

condition: Ta=25 ± 2)

Parameter	Symbol	Min.	Typ.	Max.	Unit	Remark
Supply voltage	V _{DD}	11.2	12.0	12.6	V	[Note6-7]
Current dissipation	I _{DD}	-	200	250	mA	V _{DD} = 12.0V PWM Duty = 100%
Signal Low voltage	V _{PWML}	-	-	0.8	V	PWM [Note6-8]
Signal High voltage	V _{PWMH}	1.3	-	V _{DD}	V	
PWM frequency	f _{PWM}	100	200	300	Hz	[Note6-8]
PWM Duty	—	10	-	100	%	[Note6-8]
“LED Open “ signal	V _{stH}	-	5.0	-	V	Normal
	V _{stL}	-	-	0.9	V	LED open
LED life time	L _L	-	50,000	-	Hour	PWM Duty = 100%[Note6-9]

[Note 6-7] On-off conditions for B/L supply voltage

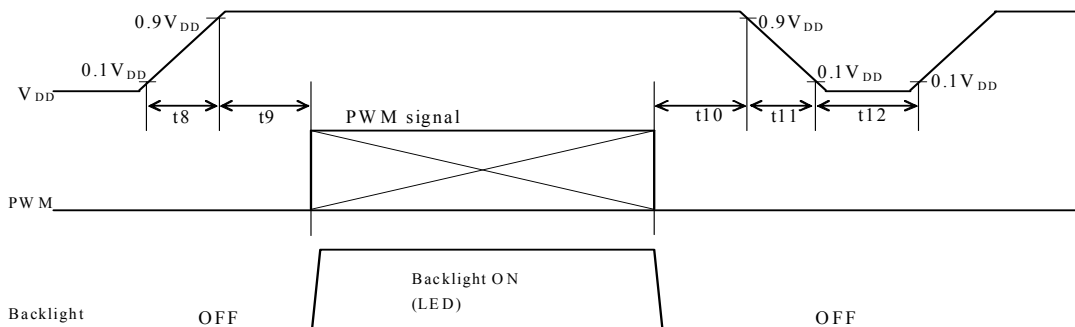

Symbol	Min.	Max.	Unit	Remarks
t ₈	0.1	10	ms	
t ₉	100	-	ms	
t ₁₀	100	-	ms	
t ₁₁	0	1	s	
t ₁₂	1	-	s	

[Note6-8]

PWM Dimmer function

PWM Dimmer function can be available by input PWM pulse.(PWM = High : ON , PWM = Low : OFF)

- Please do not make the “PWM” terminal in a floating state (no input state).
- Please input “PWM” signal after V_{DD}(12V) is supplied.
- Please turn off V_{DD}(12V) after “PWM” signal is stopped.

• Please turn off $V_{DD}(12V)$,when PWM signal is set “L” over 10ms.

If PWM signal is set “L->H” without reset V_{DD} ,Softstart function of LED driver is invalid and inrush current may occur.

OK

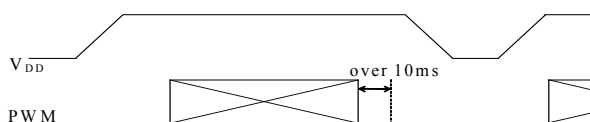

NG

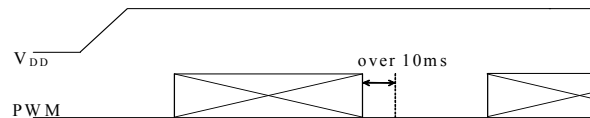

[Note 6-9] LED life time is defined as the time when Brightness becomes 50 % of the original value at $T_a=25$.

7 Timing Characteristics of input signals

7-1. Timing characteristics

Table 7-1

Parameter		Symbol	MIN	TYP	MAX	Unit	Remarks
Clock	frequency	$1/T_c$	-	6.3	7.5	MHz	
	High Width	T_{ch}	5	-	-	ns	
	Lo Width	T_{cl}	5	-	-	ns	
Data	Setup time	T_{ds}	5	-	-	ns	
	Hold time	T_{dh}	5	-	-	ns	
Horizontal sync. signal	Cycle	TH	50.0	63.6	70	μs	
			360	400	440	clock	
	Pulse width	THp	5	-	TH-2	clock	
Vertical sync. signal	Cycle	TV	250	262	284	line	【Note7-1】
	frequency	$1/TV$	50	60	-	Hz	
	Pulse width	TVp	2	-	TV-2	line	
Horizontal display period		THd	320	320	320	clock	
Hsync-Clock phase difference		THc	5	-	-	ns	
Hsync-Vsync phase difference		TVh	0	-	TH-THp	clock	
Vertical Back Porch		TVb	7	7	7	line	
Vertical Front Porch		TVf	3	-	TV-7	line	
Vertical Display Area		TVd	240	240	240	line	

[Note7-1] In case of lower frequency, the deterioration of display quality, flicker etc., may occur.

[Note7-2] Timing diagrams of input signal are shown in Fig.2

Display position of input data (H · V)are shown in Fig.1

7-2. Horizontal display position

Display position in horizontal direction is designated by rising timing of ENAB signal.

Table 7-2

Characteristics		Symbol	Min.	Typ.	Max.	Unit	Remark
DEN	Setup time	T_{es}	5	-	-	ns	
	Pulse width	T_{ep}	320	-	-	clock	
Phase difference of HSYNC - DEN		THE	6	-	TH-320	clock	

When “DEN” signal is fixed low, Horizontal display start position is fixed 52 clock. If you need other timing, please use “DEN” signal.

7-3. Vertical display position

The Vertical display start position is fixed 8 line.

ENAB signal has no relation to the vertical display position.

7-4. Input Data Signals and Display Position on the screen

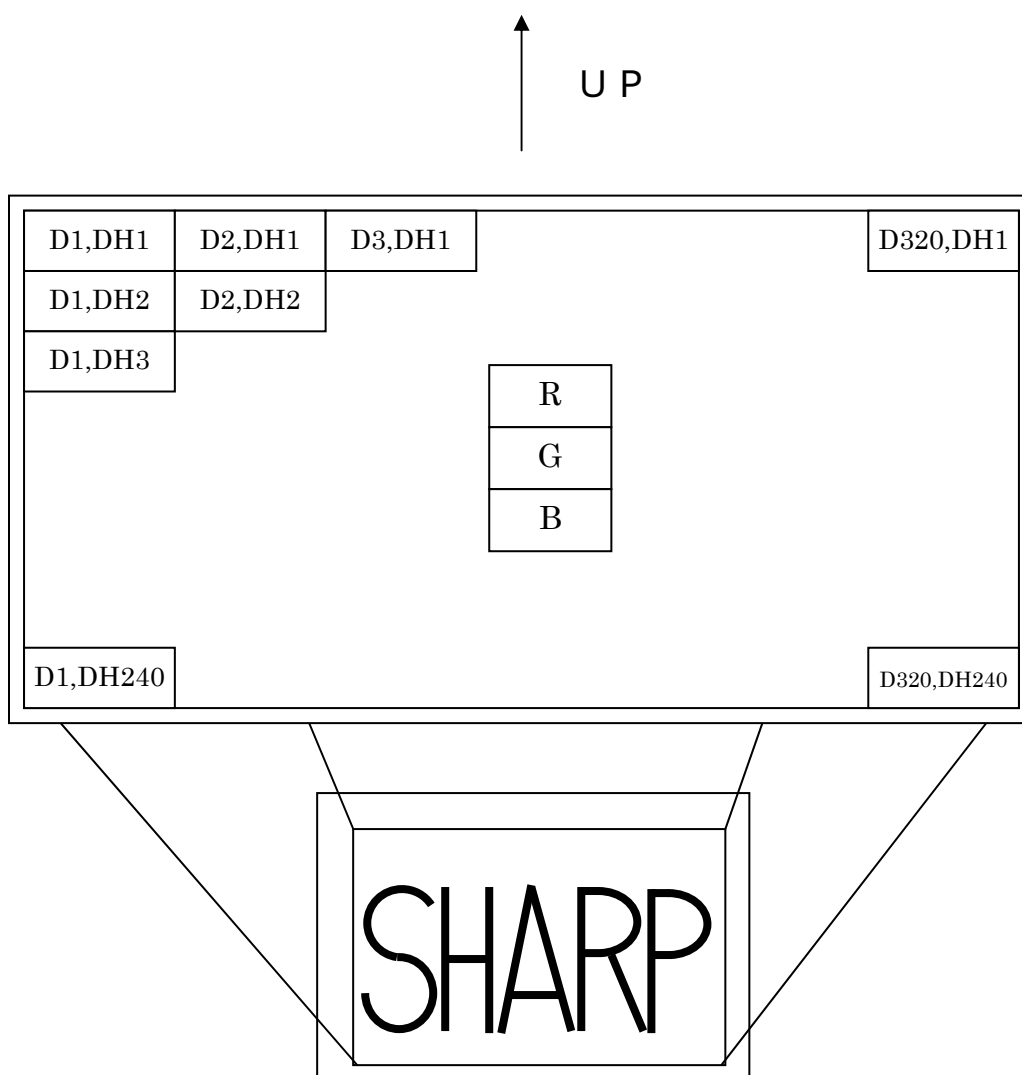

Fig1. Display position of input data(H · V)

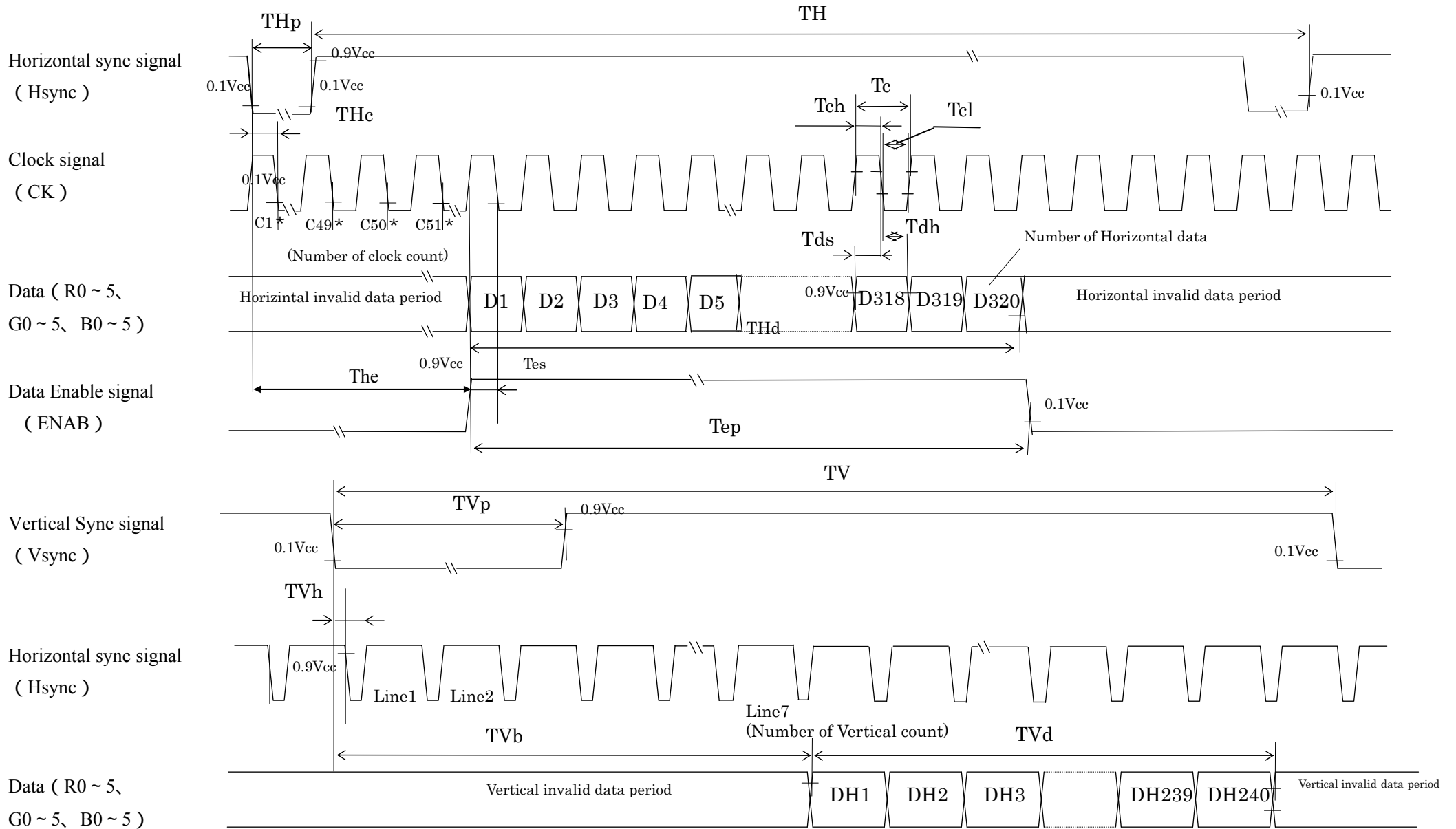

Fig 2. Input signal waveforms

8 Input Signals, Basic Display Colors and Gray Scale of Each Color

Table 8-1

	Colors & Gray scale	Data signal																		
		Gray Scale	R0	R1	R2	R3	R4	R5	G0	G1	G2	G3	G4	G5	B0	B1	B2	B3	B4	B5
Basic color	Black	-	0	0	0	0	0	0	0	0	0	0	0	0	0	0	0	0	0	0
	Blue	-	0	0	0	0	0	0	0	0	0	0	0	0	1	1	1	1	1	1
	Green	-	0	0	0	0	0	0	1	1	1	1	1	1	0	0	0	0	0	0
	Cyan	-	0	0	0	0	0	0	1	1	1	1	1	1	1	1	1	1	1	1
	Red	-	1	1	1	1	1	1	0	0	0	0	0	0	0	0	0	0	0	0
	Magenta	-	1	1	1	1	1	1	0	0	0	0	0	0	1	1	1	1	1	1
	Yellow	-	1	1	1	1	1	1	1	1	1	1	1	1	0	0	0	0	0	0
	White	-	1	1	1	1	1	1	1	1	1	1	1	1	1	1	1	1	1	1
Gray Scale of red	Black	GS0	0	0	0	0	0	0	0	0	0	0	0	0	0	0	0	0	0	0
	↑	GS1	1	0	0	0	0	0	0	0	0	0	0	0	0	0	0	0	0	0
	Darker	GS2	0	1	0	0	0	0	0	0	0	0	0	0	0	0	0	0	0	0
	↑	↓				↓					↓						↓			
	↓	↓				↓					↓						↓			
	Brighter	GS61	1	0	1	1	1	1	0	0	0	0	0	0	0	0	0	0	0	0
	↓	GS62	0	1	1	1	1	1	0	0	0	0	0	0	0	0	0	0	0	0
	Red	GS63	1	1	1	1	1	1	0	0	0	0	0	0	0	0	0	0	0	0
Gray Scale of green	Black	GS0	0	0	0	0	0	0	0	0	0	0	0	0	0	0	0	0	0	0
	↑	GS1	0	0	0	0	0	0	1	0	0	0	0	0	0	0	0	0	0	0
	Darker	GS2	0	0	0	0	0	0	0	1	0	0	0	0	0	0	0	0	0	0
	↑	↓				↓					↓						↓			
	↓	↓				↓					↓						↓			
	Brighter	GS61	0	0	0	0	0	0	1	0	1	1	1	1	0	0	0	0	0	0
	↓	GS62	0	0	0	0	0	0	0	1	1	1	1	1	0	0	0	0	0	0
	Green	GS63	0	0	0	0	0	0	1	1	1	1	1	1	0	0	0	0	0	0
Gray Scale of bleu	Black	GS0	0	0	0	0	0	0	0	0	0	0	0	0	0	0	0	0	0	0
	↑	GS1	0	0	0	0	0	0	0	0	0	0	0	0	1	0	0	0	0	0
	Darker	GS2	0	0	0	0	0	0	0	0	0	0	0	0	0	1	0	0	0	0
	↑	↓				↓					↓						↓			
	↓	↓				↓					↓						↓			
	Brighter	GS61	0	0	0	0	0	0	0	0	0	0	0	0	1	0	1	1	1	1
	↓	GS62	0	0	0	0	0	0	0	0	0	0	0	0	0	1	1	1	1	1
	Bleu	GS63	0	0	0	0	0	0	0	0	0	0	0	0	1	1	1	1	1	1

0 :Low level voltage 1 :High level voltage

Each basic color can be displayed in 64 gray scales from 6 bit data signals. According to the combination of total 18 bit data signals, the 262,144-color display can be achieved on the screen.

9 Optical Specification

Table 9-1

Ta=25°C, Vcc=3.3V

Parameter		Symbol	Condition	Min.	Typ.	Max.	Unit	Remark
Viewing angle Range	Horizontal	θ21, θ22	CR ≥ 10	70	80	-	° (Deg.)	[Note9-1,3]
	Vertical	θ11		70	80	-	° (Deg.)	
		θ12		55	65	-	° (Deg.)	
Contrast ratio		CR max	Best viewing angle	350	-	-	-	[Note9-2,4,6]
Response	Rise	Tr +Td	θ = 0°	—	30	-	ms	[Note9-2,5,6]
Chromaticity of white		x	θ = 0°	0.263	0.313	0.363	-	[Note9-2,6]
		y		0.279	0.329	0.379	-	
Luminance of white		Y _{L1}	θ = 0°	350	500	-	cd/m ²	[Note9-2,6] (PWM=100%)

The measurement shall be executed 30 minutes after lighting at rating. Condition : (PWM=100%)
The optical characteristics shall be measured in a dark room or equivalent.

[Note 9-1] Measuring Viewing Angle Range

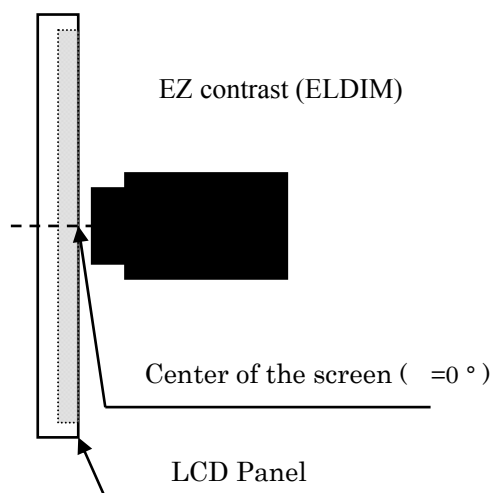

Fig3 Measuring Viewing Angle Range

[Note 9-2] Other Measurements

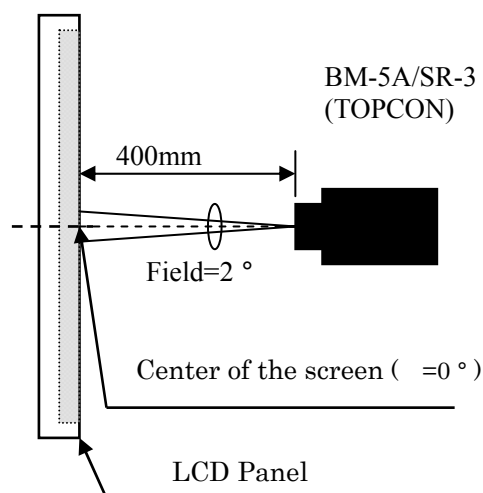
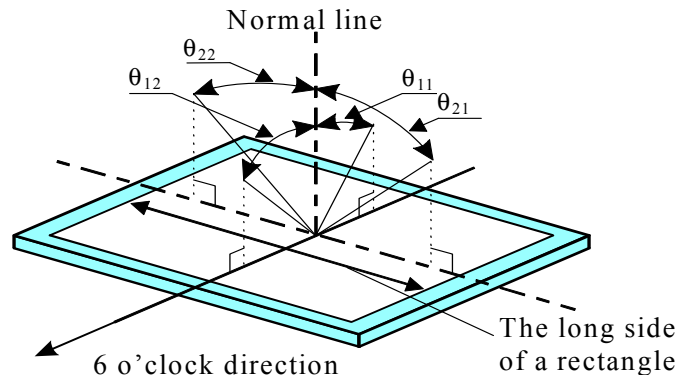

Fig4. Other Measurements

[Note9-3] Definitions of viewing angle range:



The best viewing angle of this module is slightly leaned to 12 o'clock from normal line.

Where $\theta_{11} > \theta_{max}$, gray scale is reversed partially.

Where $\theta_{11} < \theta_{max}$, or in θ_{12} direction, gray scale isn't reversed.

[Note9-4] Definition of contrast ratio:

The contrast ratio is defined as the following.

$$\text{Contrast Ratio (CR)} = \frac{\text{Central luminance (brightness) with all pixels white}}{\text{Central luminance (brightness) with all pixels black}}$$

[Note9-5] Definition of response time:

The response time is defined as the following figure and shall be measured by switching the input signal between "black" and "white" alternatively.

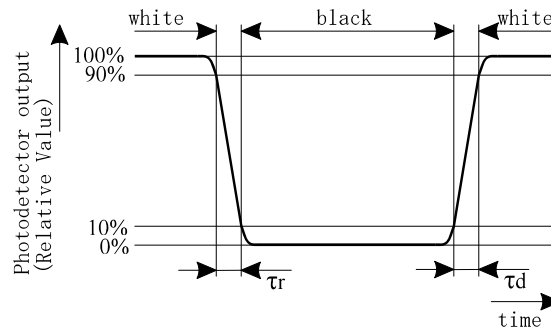

[Note9-6] This parameter should be measured at the center of the screen and 30 minutes after turn-on.

10 Display Qualities

Please refer to the Incoming Inspection Standard.

11 Handling Precautions

- a) Be sure to turn off the power supply when inserting or disconnecting the cable.
Please insert for too much stress not to join FFC/FPC in the case of insertion of FFC/FPC.
- b) Be sure to design the cabinet so that the module can be installed without any extra stress such as warp or twist.
- c) Since the front polarizer is easily damaged, pay attention not to scratch it.
- d) Wipe off water drop immediately. Long contact with water may cause discoloration or spots.
- e) When the panel surface is soiled, wipe it with absorbent cotton or other soft cloth.
- f) Since the panel is made of glass, it may break or crack if dropped or bumped on hard surface. Handle with care.
- g) Since CMOS LSI is used in this module, take care of static electricity and injure the human earth when handling. Observe all other precautionary requirements in handling components.
- h) This module has its circuitry PCBs on the rear side and should be handled carefully in order not to be stressed.
- i) Protect sheet(Laminate film) is attached to the module surface to prevent it from being scratched. Peel the sheet off slowly just before the use with strict attention to electrostatic charges. Ionized air shall be blown over during the action. Blow off the 'dust' on the polarizer by using an ionized nitrogen gun, etc. Working under the following environments is desirable.
 - All workers wear conductive shoes, conductive clothes, conductive fingerstalls and grounding belts without fail.
 - Use Ionized blower for electrostatic removal, and peel of the protect sheet with a constant speed. (Peeling of it at over 2 seconds)
- j) In case of attaching protective board over the LCD, be careful about the optical interface fringe etc. which degrades display quality.
- k) Do not expose the LCD module to a direct sunlight, for a long period of time to protect the module from the ultra violet ray.
- l) Connect GND of module bezel to stabilize against EMI and external noise.
- m) When handling LCD modules and assembling them into cabinets, please be noted that long-term storage in the environment of oxidization or deoxidization gas and the use of such materials as reagent, solvent, adhesive, resin, etc. which generate these gasses, may cause corrosion and discoloration of the LCD modules.
- n) Liquid crystal contained in the panel may leak if the LCD is broken. Rinse it as soon as possible if it gets inside your eye or mouth by mistake.
- o) Disassembling the module can cause permanent damage and should be strictly avoided.
Please don't remove the fixed tape, insulating tape etc that was pasted on the original module.
(Except for protection film of the panel.)
- p) Be careful when using it for long time with fixed pattern display as it may cause afterimage.
(Please use a screen saver etc., in order to avoid an afterimage.)
- q) If a minute particle enters in the module and adheres to an optical material, it may cause display non-uniformity issue, etc. Therefore, fine-pitch filters have to be installed to cooling and inhalation hole if you intend to install a fan.
- r) Epoxy resin (amine series curing agent), silicone adhesive material (dealcoholization series and oxime series), tray forming agent (azo compound) etc, in the cabinet or the packing materials may induce abnormal display with polarizer film deterioration regardless of contact or noncontact to polarizer film.
Be sure to confirm the component of them.
- s) Do not use polychloroprene. If you use it, there is some possibility of generating Cl₂ gas that influences the reliability of the connection between LCD panel and driver IC.
- t) Do not put a laminate film on LCD module, after peeling of the original one. If you put on it, it may cause discoloration or spots because of the occurrence of air gaps between the polarizer and the film.

u)When installing LCD modules in the cabinet, we suggest the reference torque as $0.25 \sim 0.30\text{N}\cdot\text{m}$.

Since the optimal torque varies according to the screw or building conditions, so be sure to test it in the actual use condition.

Inserting length to the module shall be within 5mm. Tapping screws shall be tighten only one time. More than two times tightening is not assured. Please take care in the case of reworking.

12 Reliability Test Items.

No.	Test parameter	Conditions
1	High temperature storage test	Leaves the module at $T_a=80^\circ\text{C}$ for 240h
2	Low temperature storage test	Leaves the module at $T_a=-30^\circ\text{C}$ for 240h
3	High temperature & high humidity operation test	Operates the module at $T_a=40^\circ\text{C}$; 90~95%RH for 240h (No condensation)
4	High temperature operation test	Operates the module with $+80^\circ\text{C}$ at panel surface(Active Area) for 240h
5	Low temperature operation test	Operates the module at $T_a=-30^\circ\text{C}$ for 240h
6	Strength against ESD	$\pm 200\text{V} \cdot 200\text{pF}(0 \quad)$ 1 time for each terminals
7	Shock test (non- operating)	Max. acceleration : 490m/s^2 Pulse width : 11ms, half sine wave Direction : $\pm X, \pm Y, \pm Z$ once for each direction.
8	Vibration test (non- operating)	Frequency : $5 \sim 57\text{Hz}$ /Vibration width (one side): 0.076 mm : $57 \sim 500\text{Hz}$ / acceleration: 9.8m/s^2 Sweep time : 11 minutes Test period : 1 hour for each direction of X,Y,Z (total 3 hours)
9	Thermal shock test	$-30^\circ\text{C} \sim +80^\circ\text{C}$ /50 cycle [0.5h] [0.5h]

[Result Evaluation Criteria]

Under the display quality test conditions with normal operation state, these shall be no change which may affect practical display function. (normal operation state : Temperature: $15 \sim 35$, Humidity: $45 \sim 75\%$, Atmospheric pressure: $86 \sim 106\text{kpa}$)

[Note 12-1] The directions of X, Y, Z are defined as below:

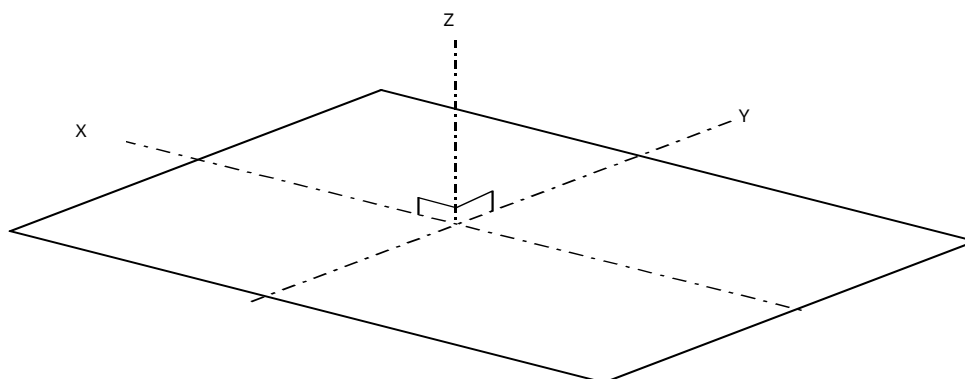

13 Packing Form

Piling number of cartons	Max.9
Package quantity in one carton	30pcs
Carton size	349(W) × 584(D) × 196(H) mm
Total mass of one carton filled with full modules	7kg
Packing form	Fig.5

14 Marking of product name

1) Module label:

Notation: Model No. Serial No.

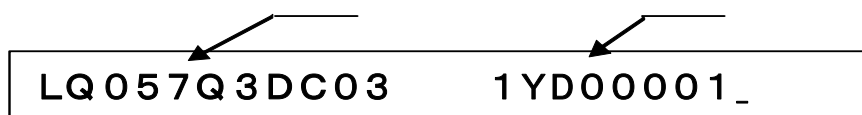

Details of Serial No

(Example) 1 Y D 0 0 0 0 1

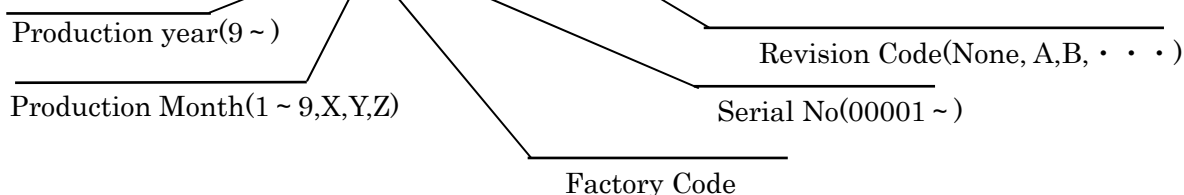

[Note] Production year : 9(2009)、0(2010)、1(2011)、・・・
 Production Month : 1(Jan)、2(Feb)、・・・、9(Sep)、X(Oct)、Y(Nov)、Z(Dec)

2) Packing bar code label

Notation/ Bar code: Model No. Date Quantity

社内品番: (4S)LQ057Q3DC03 ←
Bar code(①)
Lot No. : (1T)2011. 11. 01 ←
Bar code(②)
Quantity: (Q) 30 pcs ←
Bar code(③)
ユーザ品番 :
シャープ物流用ラベルです。

15 RoHS Directive

This LCD module is compliant with RoHS Directive.

Carton mark (Printed on carton box)



16 Storage conditions

<Environmental condition range of storage temperature and humidity>

Temperature 0 to 40 degrees Celsius

Relative humidity 70% and below

Direct sun light

Please keep the product in a dark room or cover the product to protect from direct sun light.

Atmospheric condition

Please refrain from keeping the product with possible corrosive gas or volatile flux.

Prevention of dew

* Please store the product carton either on a wooden pallet or a stand / rak to prevent dew.

Do not place directly on the floor. In addition, to obtain moderate ventilation in between the pallet's top and bottom surfaces, pile the cartons up in a single direction and in order.

* Please place the product cartons away from the strage wall.

* Please maintain the storage area with an appropriate ventilation. It is recommendable to furnish the storage area with equipments such as ventilation systems.

* Please maintain the ambient temperature within the range of natural environmental fluctuation.

Storage term

1 year

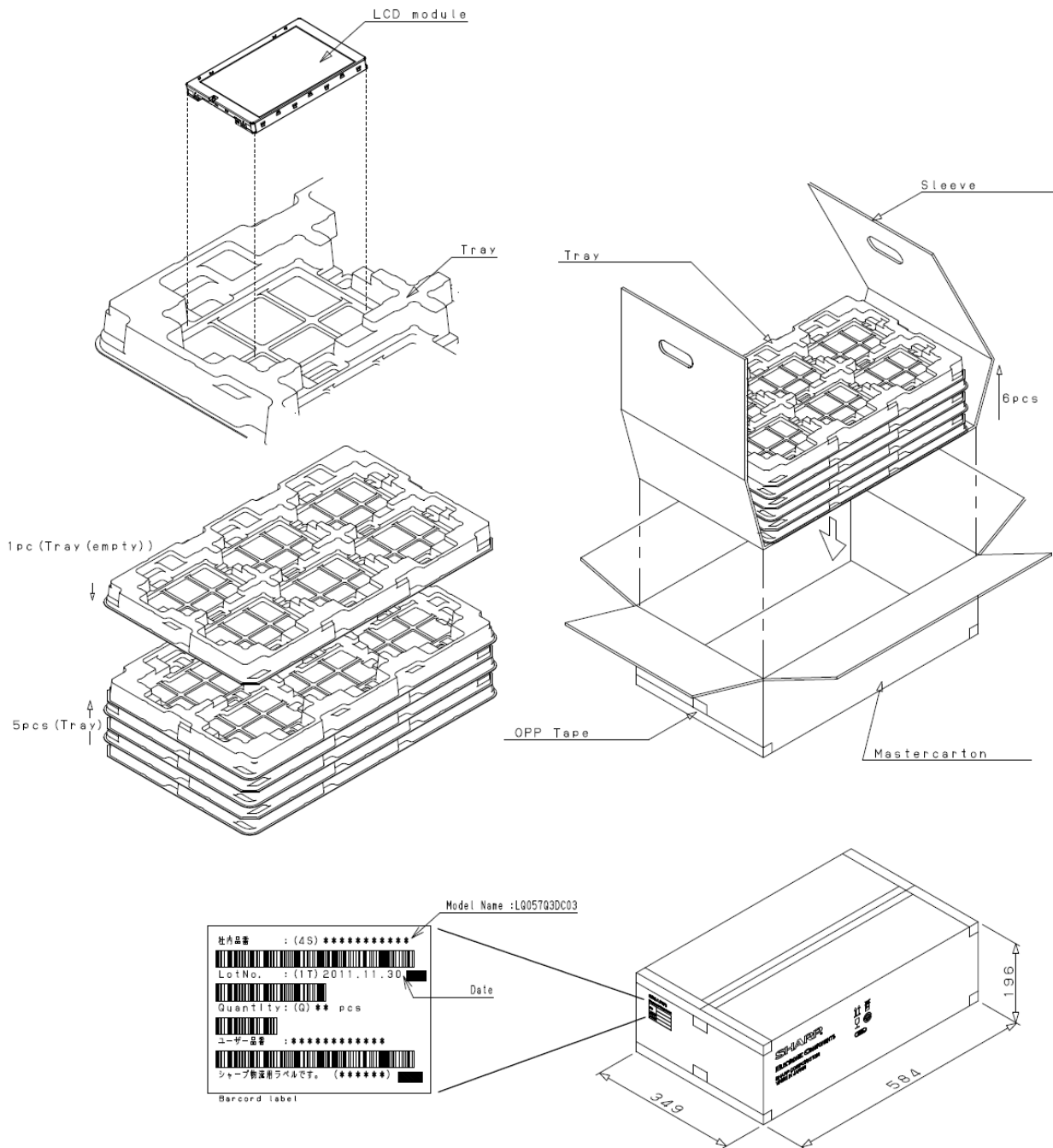
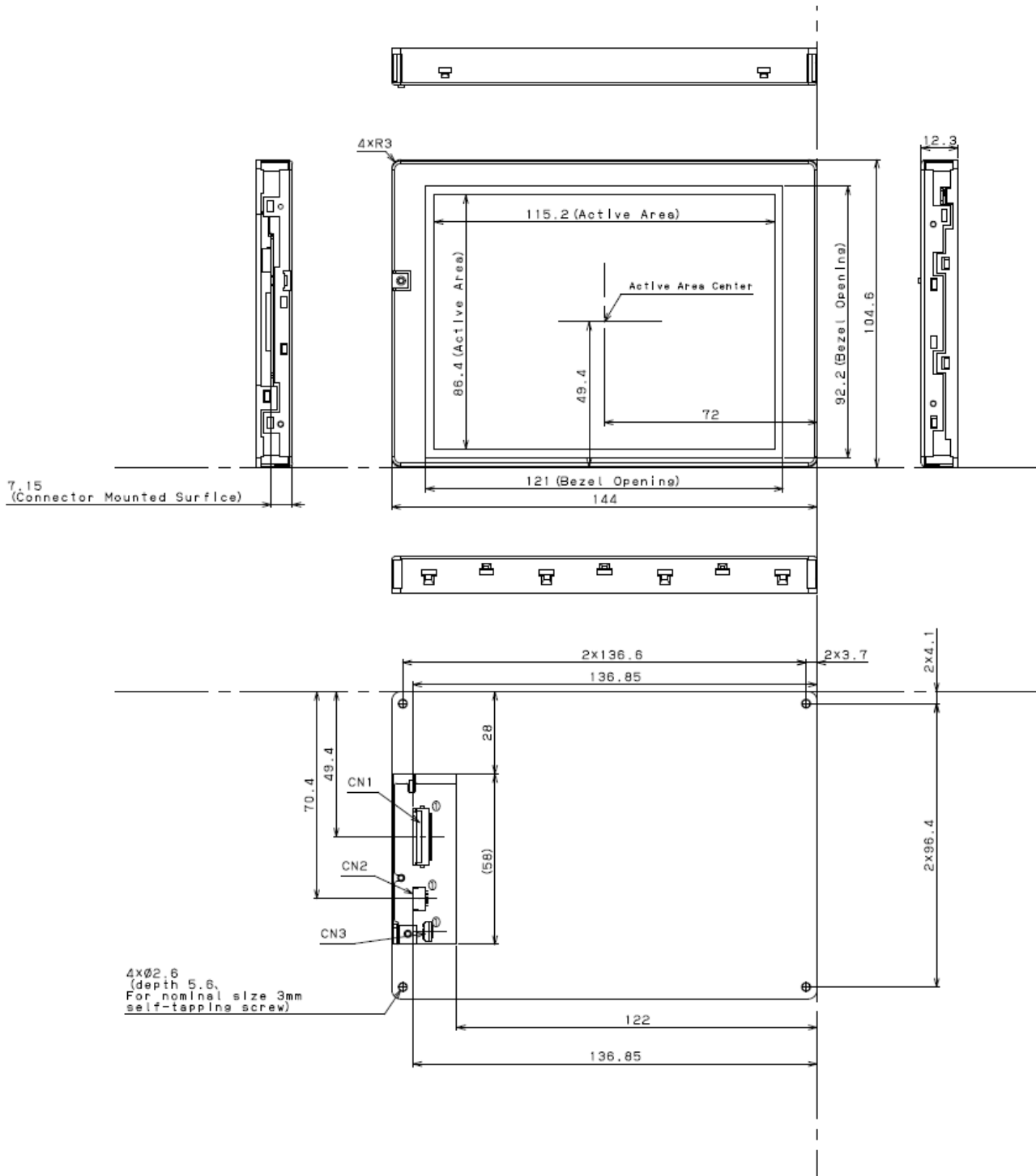

Fig.5 Packing Form



- General tolerance ± 0.5
- CN3 is a test connector of the LCD module. Please do not connect FFC or FPC.

Fig.6 Outline Dimensions