

User Manual

iR-COP User Manual

This guide walks through important information for iR-COP

UM018001E_20220307

Table of Contents

1	Product Overview	1
2	Specifications	2
3	LED Indicators	3
3.1	LV LED.....	3
3.2	IO RUN/ERR LED.....	3
3.3	CAN-RUN LED.....	3
3.4	CAN-ERR LED.....	3
4	Configuration	4
4.1	Node Setting	4
4.2	Baud Rate Setting (DIP Switch)	4
4.3	CAN Bus Connect	4
4.4	CANopen Features	4
5	Communication Error Control	5
5.1	Introduction	5
5.2	Node Guarding Protocol	5
5.3	Heartbeat Protocol	6
5.4	Error Behavior	7
6	Object Dictionary	8
6.1	Communication Profile Area.....	8
6.1.1	1000h: Device Type.....	9
6.1.2	1001h: Error Register	10
6.1.3	1002h: Manufacturer Status Register	10
6.1.4	1003h: Predefined Error Field.....	11
6.1.5	1005h: SYNC COB-ID Message	13
6.1.6	1008h: Manufacturer Device Name.....	13
6.1.7	1009h: Manufacturer Hardware Version	13
6.1.8	100Ah: Manufacturer Software Version	13
6.1.9	100Ch: Guard Time & 100Dh: Life Time Factor	13
6.1.10	1010h: Store Parameters	13
6.1.11	1011h: Restore Default Parameters.....	13
6.1.12	1014h: COB-ID EMCY	19
6.1.13	1015h: Inhibit Time EMCY.....	19
6.1.14	1016h: Consumer Heartbeat Time	19
6.1.15	1017h: Producer Heartbeat Time	19
6.1.16	1029h: Error Behavior Object	19
6.2	PDO Communication Parameter.....	20
6.2.1	RxPDO Communication Parameter	20

6.2.2	TxPDO Communication Parameter	21
6.2.3	PDO Mapping Parameter	23
6.2.4	Mapping Parameter	27
6.3	I/O Device Object Dictionary.....	27
6.3.1	Read Digital Input.....	27
6.3.2	Write Digital Output.....	29
6.3.3	Read Analog Input.....	30
6.3.4	Write Analog Output.....	30
6.4	Manufacturer-specific Profile Area.....	30
6.4.1	2000h~2001h: Digital Input Filter	30
6.4.2	3000h~300Fh: Module Registers	30
6.4.3	4000h~4007h: iBus and Module Information.....	31
7	Power Consumption	32
8	Connecting Remote I/O using CODESYS	33
9	Configuring Analog Modules in CODESYS.....	33
9.1	Add SDO	33
9.1.1	Write Analog Input.....	33
9.1.2	Write Analog Output.....	34
9.1.3	Write Temperature Input	35
9.2	Weintek_Library Function Block	36
9.2.1	Analog_Config – Read/Write a Single Register	36
9.2.2	AI_Ch_Pa – Read/Write the Channel of Analog Input	38
9.2.3	AO_Ch_Pa – Read/Write the Channel of Analog Output.....	40
9.2.4	Analog_VI_Read – Read all Registers of Analog Module.....	42
	Appendix 1. Resources	45

Other company names, product names, or trademarks in this document are the trademarks or registered trademarks of their respective companies.

This document is subject to change without notice.

Copyright© 2018 Weintek Labs., INC. All rights reserved.

1 Product Overview

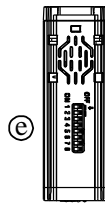

Top View

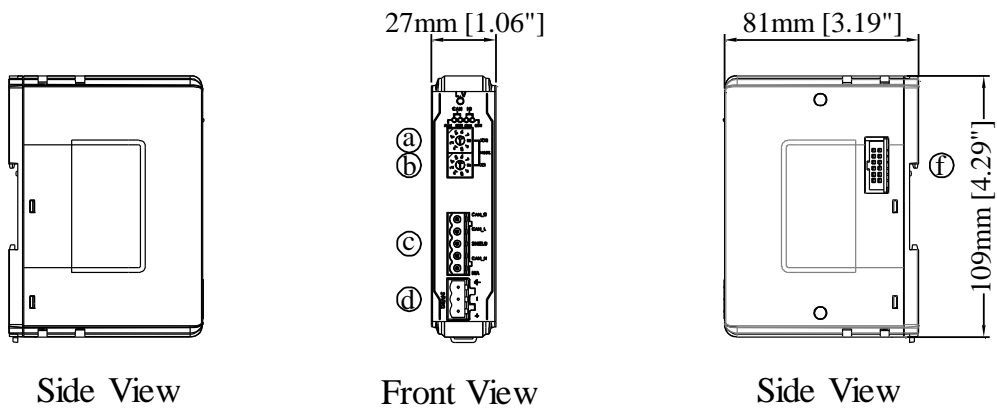

Side View

Front View

Side View

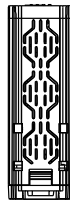

Bottom View

<i>a</i>	Node ID rotary switch x10	<i>e</i>	Baud Rate DIP Switch
<i>b</i>	Node ID rotary switch x1	<i>f</i>	Expansion Connector
<i>c</i>	CAN bus Connector		
<i>d</i>	Power Connector		

2 Specifications

Communication Interface Specifications							
Expansion I/O Module	No. of Bus Terminals		Depends on Power Consumption. Max. allowable number of iR modules is 16.				
	Digital Input Point		Max. 256				
	Digital Output Point		Max. 128				
	Analog Input Channel		Max. 64				
	Analog Output Channel		Max. 64				
Indicators	CAN RUN (Green)		CANopen Status Indicator				
	CAN ERR (Red)		CANopen Error Indicator				
	L.V (Red)		Low Voltage Status Indicator				
	IO RUN (Green)		Module Status Indicator				
	IO ERR (Red)		Module Error Indicator				
Data Transfer Rate	1M	800k	500k	250k	125k	100k	50k
Length of the Cable	20m	50m	100m	250m	500m	600m	1,000m
Number of PDOs (CANopen)	8 Transmit PDOs / 8 Receive PDOs						
Process Data Operating Modes	synchronous, event-driven ,event timer, polling						
Number of SDOs Available	1 Standard SDOs						
Bus Connection	1 x open style connector, 5-pole, plug included						
Additional CANopen Features	life/node guarding, heartbeat, emergency object, variables mapping, store/restore, output error mode.						
General Specification							
Power	Power Supply		24 VDC (-15%/+20%)				
	Power Dissipation		Nominal 24VDC@ 100mA				
	Current for Internal Bus		Max 2A @ 5VDC				
	Current Consumption		170mA @ 5VDC				
	Electrical Isolation		Isolated CANopen : Yes Isolated power : Yes				
	Back-up Fuse		≤ 1.6A Self-recovery				
Specification	PCB Coating		Yes				
	Enclosure		Plastic				
	Dimensions WxHxD		27 x 109 x 81 mm				
	Weight		Approx. 0.15 kg				
	Mount		35mm DIN rail mounting				
Environment	Protection Structure		IP20				
	Storage Temperature		-20° ~ 70°C (-4° ~ 158°F)				
	Operating Temperature		0° ~ 55°C (32° ~ 131°F)				
	Relative Humidity		10% ~ 90% (non-condensing)				
Connection	Cross-section		0.5 mm ² ... 2.5 mm ² , stranded, solid wire, AWG 26-12				
Certification	EMC Immunity		Conforms to EN 55032: 2012+AC: 2013, Class A EN 61000-6-4: 2007+A1:2011 EN 55024: 2010+A1: 2015 EN 61000-6-2:2005				

3 LED Indicators

3.1 L.V LED

L.V LED state	Description
OFF	24V power normal
Blinking	Detect 24V power
ON	24V power error

3.2 IO RUN/ERR LED

RUN LED	ERR LED	Description
OFF	OFF	Power off or no power
Blinking	OFF	IO initiating
Blinking	ON	IO initiation error
ON	OFF	IO working
ON	Blinking	IO module alarm
ON	ON	IO communication fault

3.3 CAN-RUN LED

NO	CAN-RUN LED	State	Description
1	ON	OPERATIONAL	The device is in the OPERATIONAL state.
2	Blinking	PRE_OPERATIONAL	The device is in the PRE_OPERATIONAL state.
3	Single flash	STOPPED	The device is in the STOPPED state.

3.4 CAN-ERR LED

NO	CAN-ERR LED	State	Description
1	ON	CAN Bus off	The CAN Bus controller is off.
2	Triple flash	SYNC error	The SYNC message has not been received within the configured communication cycle period time out (see Object Dictionary Entry 1006h).
3	Double flash	Error control event	A guarding event (NMT-Slave or NMT-master) or a heartbeat event (Heartbeat consumer) has Occurred.
4	Single flash	Warning limit reached	At least one of the error counters of the CAN Bus controller has reached or exceeded the warning level (too many error frames).
5	Blinking	Invalid configuration	General configuration error.
6	OFF	No error	The Device is in working condition.

4 Configuration

4.1 Node Setting

The node ID is set by Rotary Switches, range from 1 to 99 (0 is not allowed).



Setting	Description
0	Invalid Node ID
1~99	Valid Node ID

4.2 Baud Rate Setting (DIP Switch)

SW4	SW3	SW2	SW1	Baud Rate
0	0	0	0	Auto rate
0	0	0	1	1Mbps
0	0	1	0	800Kbps
0	0	1	1	500Kbps
0	1	0	0	250Kbps
0	1	0	1	125Kbps
0	1	1	0	100Kbps
0	1	1	1	50Kbps
SW5-7	Reserved			
SW8	CAN Bus 120Ω Terminator			

4.3 CAN Bus Connect

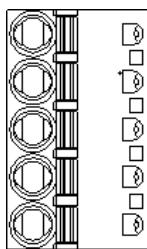

PIN#	Name
1	CAN_G
2	CAN_L
3	SHIELD
4	CAN_H
5	N/A

4.4 CANopen Features

- 8 TxPDO
- 8 RxPDO
- 1 Standard SDO
- Emergency object (EMCY)
- Synchronization object (SYNC, without time stamp)
- Guarding
- Heartbeat
- NMT objects

5 Communication Error Control

5.1 Introduction

Node Guarding protocol and Heartbeat protocol can be used to detect device failures on a CANopen network, please use one of these two protocols at a time.

5.2 Node Guarding Protocol

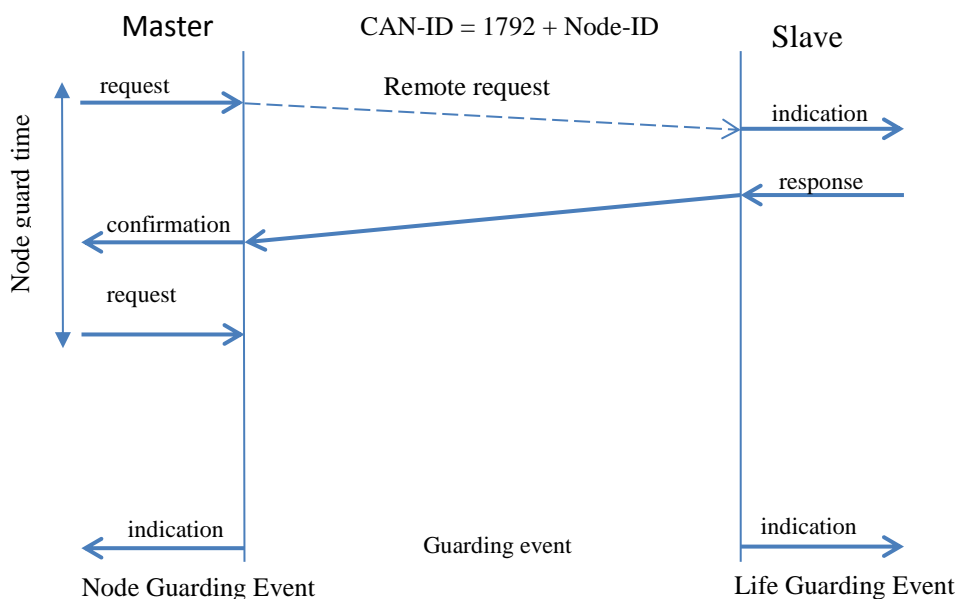

With Node Guarding, a certain network node (NMT-master) sends a remote transmit request to the other nodes (NMT-slave) in the network one after the other (polling) at defined intervals (Node Guard Time). The NMT-slaves respond to the request by transmitting a data telegram with its current communication state: Pre-operation, Operation, Stopped, within a certain time (Node Life Time). The format of the telegram is as below:

Bit7	Bit6~Bit0
Toggle bit.	4: Stopped 5: Operational 127: Pre-operational

Node Life Time is calculated by multiplying two parameters: Guard Time (100Ch) and Life Time Factor (100Dh).

$$\text{Node Life Time} = \text{Life Time Factor} \times \text{Guard Time (ms)}$$

Guard Time				
Index	Sub Index	Data Type	Default Value	Description
100Ch	00h	UNSIGNED16	0000h	0:Disable

Life Time Factor				
Index	Sub Index	Data Type	Default Value	Description
100Dh	00h	UNSIGNED8	00h	0:Disable

The NMT-slaves also monitor whether they have received a request from the NMT-master within “Node Life Time”. If the request was absent for longer than the life time, the NMT-slaves assume that the NMT-master has failed and indicates this as a “Life Guarding Event” to the host controller.

5.3 Heartbeat Protocol

Heartbeat protocol is an error control service that does not require remote frames. According to the heartbeat principle, a Heartbeat Producer automatically transmits its communication state at regular intervals to the Heartbeat Consumers, as an evidence of its communication ability. The Heartbeat Consumer Time describes the maximum time within which the arrival of a heartbeat message is expected by a Heartbeat Consumer. Absence of the heartbeat message for longer than Heartbeat Consumer Time will be indicated by the Heartbeat Consumer as a Heartbeat Event to the host controller.

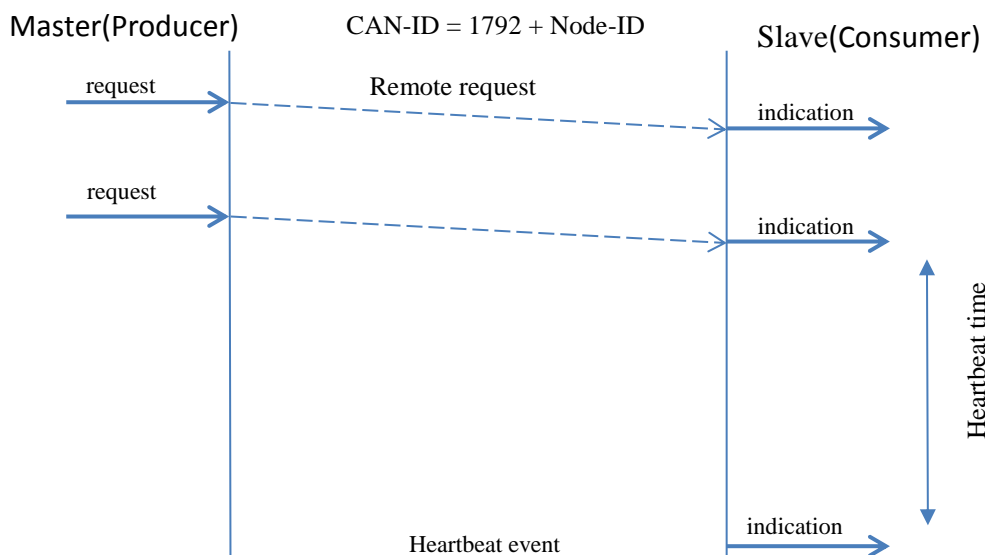

Producer Heartbeat Time				
Index	Sub Index	Data Type	Default Value	Description
1017h	00h	UNSIGNED16	00h	0:Disable (unit:ms)

Consumer Heartbeat Time				
Index	Sub Index	Data Type	Default Value	Description
1016h	00h	UNSIGNED32	00h	---

Bit31-24	Bit23-16	Bit15-0
Reserved(00h)	Node-ID	Heartbeat Time

- Node ID: The heartbeat mechanism is disabled when the ID is 0 or larger than 127.
- Heartbeat time unit: ms

Please note that Consumer Heartbeat Time should be longer than Producer Heartbeat time.

5.4 Error Behavior

When a Life Guarding Event or Heartbeat Event occurs:

The state can be configured via the object dictionary entry (Error Behavior Object).

Error Behavior Object		
Index	Sub Index	Description
1029h	01h	0 : Change to NMT state Pre-operational. (If currently in NMT state Operational) 1 : No change of the NMT state. 2 : Change to NMT state Stopped.

Digital / Analog Output can be configured via error mode and error output value.

If Error Mode is enabled when an event occurs, the output value will be given in Error Value.

If Error Mode is disabled when an event occurs, the output value remains the same.

Index 6206 : Error mode digital output (8-bit)			
Sub Index	Description		Default
00h	Highest sub-index supported		
01h	Error mode output 01h to 08h	0 : output value remains same 1 : output value is given in 6207h	FFh
02h	Error mode output 09h to 10h		FFh
03h-FEh	Error mode output 11h to 7F0h		FFh

Index 6207 : Error value digital output (8-bit)

Sub Index	Description	Default
00h	Highest sub-index supported	
01h	Error Value output 01h to 08h	00h
02h	Error Value output 09h to 10h	00h
03h-FEh	Error Value output 11h to 7F0h	00h

Index 6443 : Analog output error mode		
Sub Index	Description	Default
00h	Highest sub-index supported	
01h	Error mode analog output 01h	0 : output value remains same 1 : output value is given in 6444h others = reserved
02h	Error mode analog output 02h	
03-FEh	Error mode analog output 03-FEh	

Index 6444 : Analog output error value integer		
Sub Index	Description	Default
00h	Highest sub-index supported	
01h	Analog output 01h	0000 000h
02h	Analog output 02h	0000 000h
03-FEh	Analog output 03h-FEh	0000 000h

6 Object Dictionary

Object Area	Index range (hex)
Communication Profile Area	1000-1FFF
Manufacturer Specific Profile Area	2000-5FFF
Standardized Device Profile Area	6000-9FFF

6.1 Communication Profile Area

Index	Sub Index	Description	Type	ro/rw	Default
1000h	00h	Device type	UNSIGNED32	ro	---
1001h	00h	Error register	UNSIGNED8	ro	0
1002h	00h	Manufacturer status register	UNSIGNED32	ro	0
	01h	Module alarm code	UNSIGNED32	ro	0
	02h	Module disconnected code	UNSIGNED32	ro	0

	03h	iBus initialization error code	UNSIGNED32	ro	0
1003h	00h	Error code (no. of sub-index)	UNSIGNED32	rw	0
	01h	Emergency error code (newest)	UNSIGNED32	ro	0
	02-3Fh	Emergency error code	UNSIGNED32	ro	0
	40h	Emergency error code (newest)	UNSIGNED32	ro	0
1005h	00h	SYNC COB-ID message	UNSIGNED32	ro	00000080h
1008h	00h	Manufacturer device name	STRING	ro	'iR-COP'
1009h	00h	Manufacturer hardware version	STRING	ro	'1.00.0'
100Ah	00h	Manufacturer software version	STRING	ro	'1.00.0'
100Ch	00h	Guard time	UNSIGNED16	rw	0
100Dh	00h	Life time factor	UNSIGNED8	rw	0
1014h	00h	COB-ID EMCY	UNSIGNED32	rw	80h + Node-ID
1015h	00h	Inhibit time EMCY	UNSIGNED16	rw	0
1016h	00h	Number of sub-index	UNSIGNED8	ro	0
	01h	Consumer heartbeat time	UNSIGNED32	rw	0
1017h	00h	Producer heartbeat time	UNSIGNED16	rw	0
1018h		Identity object			
	00h	Number of sub-index	UNSIGNED8	ro	04h
	01h	Vendor-ID	UNSIGNED32	ro	0000044Eh
	02h	Product code	UNSIGNED32	ro	00000701h
	03h	Revision number	UNSIGNED32	ro	---
	04h	Serial number	UNSIGNED32	ro	---
1027h	00h	Number of connected modules	UNSIGNED8	ro	01h – 10h
	01-10h	Module 1-16 of Device code	UNSIGNED16	ro	----
1029h		Error behavior object			
	00h	Number of sub-index	UNSIGNED8	ro	01h
	01h	Communication error	UNSIGNED8	rw	0

6.1.1 1000h: Device Type

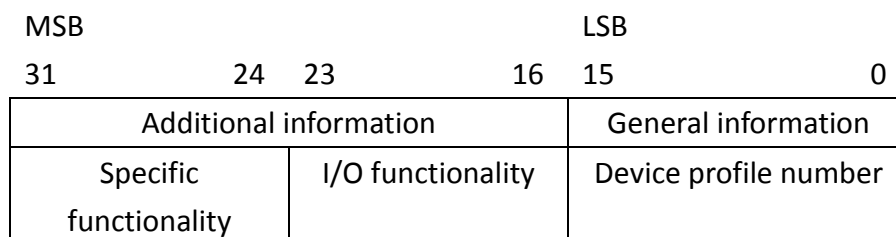

- Specific functionality: Remains 0 since iR-COP model does not have specific functionality.
- General information: 191h according to document DS-401
- I/O functionality:
 - When bit 16 is 1: Digital input channel exists.
 - When bit 17 is 1: Digital output channel exists.
 - When bit 18 is 1: Analog input channel exists.
 - When bit 19 is 1: Analog output channel exists.
 - Bit 20 to 23 reserved: Value is 1.

6.1.2 1001h: Error Register

Please find 1003h for more information on error registers.

Bit	Meaning
0	Generic error
1	Current error
2	Voltage error
3	Temperature error
4	Communication error
5	Pertains to the device profile
6	Reserved(0)
7	Manufacturer specific

6.1.3 1002h: Manufacturer Status Register

Bit	Description
0	Low power alarm
1	Hardware error
2	Reserved
3	Heartbeat event
4	Guarding event
5	CAN in error passive mode
6	CAN overrun
7	Module lost connection
8	Module alarm
9	iBus initialization fault
10	Number of iBus exceeds 16
11	Power consumption exceeded

	at iBus system
--	----------------

- Sub Index 01: Module alarm
 Bit0 is 1 means that the alarm is triggered by the first module, and Bit2 is 1 means that the alarm is triggered by the second module, and so on.
- Sub Index 02: Module lost connection
 Bit0 is 1 means that the first module has lost its connection, and Bit2 is 1 means that the second module has lost its connection, and so on.
- Sub Index 03: iBus initialization error
- Sub Index 01: Error bit (Error Code)

6.1.4 1003h: Predefined Error Field

When an error occurs, Emergency Object will be generated and recorded in Predefined Error Field, providing an Error History.

Sub Index 01 and more: Number of error records

Setting index 0 to 0 will erase the field, and index 0 can only be set to 0.

Setting index 0 to values other than 0 will make SDO reply abort 0609 and 0030h.

Bit0~15 describe Error Code while Bit16~31 provide additional information.

Byte:

MSB

LSB

Additional information	Error code
------------------------	------------

Emergency Error Codes:

Error Code (hex)	Meaning
00xx	Error Reset or No Error
10xx	Generic Error
20xx	Current
21xx	Current, device input side
22xx	Current inside the device
23xx	Current, device output side
30xx	Voltage
31xx	Mains Voltage
32xx	Voltage inside the device
33xx	Output Voltage
40xx	Temperature
41xx	Ambient Temperature

42xx	Device Temperature
50xx	Device Hardware
60xx	Device Software
61xx	Internal Software
62xx	User Software
63xx	Data Set
70xx	Additional Modules
80xx	Monitoring
81xx	Communication
8110	CAN Overrun (Objects lost)
8120	CAN in Error Passive Mode
8130	Life Guarding Error or Heartbeat Error
8140	Recovered from bus off
8150	Transmit COB-ID collision
82xx	Protocol Error
8210	PDO not processed due to length error
8220	PDO length exceeded
90xx	External Error
F0xx	Additional Functions
FFxx	Device Specific

iR-COP Error Registers:

Error Register	Predefined Error Field	Description
01h	3100h	Low power alarm
01h	5000h	Hardware error
10h	8100h	CAN Bus off (Reserved)
10h	8130h	Heartbeat event
10h	8130h	Guarding event
10h	8120h	CAN in error passive mode
10h	8110h	CAN overrun
80h	7000h	Module lost connection
80h	7001h	Module alarm
80h	7002h	iBus initialization fault
80h	7003h	Number of iBus exceeds 16

80h	7004h	Power consumption exceeded at iBus system
-----	-------	---

6.1.5 1005h: SYNC COB-ID Message

The COB-ID used for the SUNC message.

Bit0~10: SYNC COB-ID

Bit11~31: iR-COP is 0

6.1.6 1008h: Manufacturer Device Name

Contains the device name as a string: iR-COP

6.1.7 1009h: Manufacturer Hardware Version

Contains the device hardware version as a string: 1.00.0

6.1.8 100Ah: Manufacturer Software Version

Contains the device software version as a string: 1.00.0

6.1.9 100Ch: Guard Time & 100Dh: Life Time Factor

Guard Time and Life Time Factor are used in Node Guarding Protocol.

Setting 100C to 0 will disable guarding function.

Life Time = Life Time Factor * Guard Time (ms)

(Please find more details in Node Guarding Protocol in this manual.)

6.1.10 1010h: Store Parameters

This object shall control the saving of parameters in non-volatile memory.

VALUE DEFINITION

- Sub Index 01h: refers to all parameters that may be stored on the CANopen device.
- Sub Index 02h: refers to communication related parameters (index from 1000_h to 1FFF_h).
- Sub Index 03h refers to application related parameters (index from 6000_h to 9FFF_h).

MSB		LSB	
e	v	a	s
65 _h	76 _h	61 _h	73 _h

Storage write access signature

6.1.11 1011h: Restore Default Parameters

With this object the default values of parameters according to the communication profile, device profile, and application profile are restored.

Sub Index 01h: refers to all parameters that may be restored

Sub Index 02h: refers to communication related parameters (Index from 1000_h to

1FFF_h).

Sub Index 03_h: refers to application related parameters (Index from 6000_h to 9FFF_h).

MSB		LSB	
d	a	o	l
64 _h	61 _h	6F _h	6C _h

Restore default write access signature

The default values shall be set valid after the CANopen device is reset (NMT service reset node for sub-index from 01_h to 7_h, NMT service reset communication for sub-index 02_h) or power cycled.

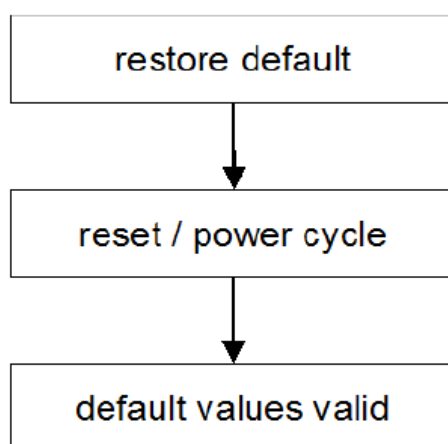

Communication Parameters (1000_h~1FFF_h):

Index	Sub-index	Description	Type	Default
100Ch	00h	Guard time	UNSIGNED16	0
100Dh	00h	Life time factor	UNSIGNED8	0
1014h	00h	EMCY COB-ID	UNSIGNED32	80h + Node-ID
1015h	00h	EMCY inhibit time	UNSIGNED16	0
1016h	01h	Consumer heartbeat time	UNSIGNED32	0
1017h	00h	Producer heartbeat time	UNSIGNED16	0
1029h	01h	Communication error	UNSIGNED8	0
1400h	01h	COB-ID used by RPDO1	UNSIGNED32	200h + Node-ID
	02h	Transmission type of RPDO1	UNSIGNED8	FFh
1401h	01h	COB-ID used by RPDO2	UNSIGNED32	300h + Node-ID
	02h	Transmission type of RPDO2	UNSIGNED8	FFh
1402h	01h	COB-ID used by RPDO3	UNSIGNED32	400h + Node-ID
	02h	Transmission type of RPDO3	UNSIGNED8	FFh
1403h	01h	COB-ID used by RPDO4	UNSIGNED32	500h + Node-ID

	02h	Transmission type of RPDO4	UNSIGNED8	FFh
1404-1407h	01h	COB-ID used by RPDO5-8	UNSIGNED32	8000000
	02h	Transmission type of RPDO5-8	UNSIGNED8	FFh
1800h	01h	COB-ID used by TPDO1	UNSIGNED32	180h + Node-ID
	02h	Transmission type of TPDO1	UNSIGNED8	FFh
	03h	Inhibit time of TPDO1	UNSIGNED16	0
	05h	Event timer of TPDO1	UNSIGNED16	0
1801h	01h	COB-ID used by TPDO2	UNSIGNED32	280h + Node-ID
	02h	Transmission type of TPDO2	UNSIGNED8	FFh
	03h	Inhibit time of TPDO2	UNSIGNED16	0
	05h	Event timer of TPDO2	UNSIGNED16	0
1802h	01h	COB-ID used by TPDO3	UNSIGNED32	380h + Node-ID
	02h	Transmission type of TPDO3	UNSIGNED8	FFh
	03h	Inhibit time of TPDO3	UNSIGNED16	0
	05h	Event timer of TPDO3	UNSIGNED16	0
1803h	01h	COB-ID used by TPDO4	UNSIGNED32	480h + Node-ID
	02h	Transmission type of TPDO4	UNSIGNED8	FFh
	03h	Inhibit time of TPDO4	UNSIGNED16	0
	05h	Event timer of TPDO4	UNSIGNED16	0
1804-7h	01h	COB-ID used by TPDO5-8	UNSIGNED32	280h + Node-ID
	02h	Transmission type of TPDO5-8	UNSIGNED8	FFh
	03h	Inhibit time of TPDO5-8	UNSIGNED16	0
	05h	Event timer of TPDO5-8	UNSIGNED16	0
1600h	00h	Number of mapped application objects in RPDO1	UNSIGNED8	08h
	01h	1st application object	UNSIGNED32	6200 01 08h
	02h	2st application object	UNSIGNED32	6200 02 08h
	03h	3st application object	UNSIGNED32	6200 03 08h
	04h	4st application object	UNSIGNED32	6200 04 08h
	05h	5st application object	UNSIGNED32	6200 05 08h
	06h	6st application object	UNSIGNED32	6200 06 08h
	07h	7st application object	UNSIGNED32	6200 07 08h
	08h	8st application object	UNSIGNED32	6200 08 08h
1601h	00h	Number of mapped application objects in RPDO2	UNSIGNED8	04h

	01h	1st application object	UNSIGNED32	6411 01 10h
	02h	2st application object	UNSIGNED32	6411 02 10h
	03h	3st application object	UNSIGNED32	6411 03 10h
	04h	4st application object	UNSIGNED32	6411 04 10h
1602h	00h	Number of mapped application objects in RPDO3	UNSIGNED8	04h
	01h	1st application object	UNSIGNED32	6411 05 10h
	02h	2st application object	UNSIGNED32	6411 06 10h
	03h	3st application object	UNSIGNED32	6411 07 10h
	04h	4st application object	UNSIGNED32	6411 08 10h
1603h	00h	Number of mapped application objects in RPDO4	UNSIGNED8	04h
	01h	1st application object	UNSIGNED32	6411 09 10h
	02h	2st application object	UNSIGNED32	6411 0A 10h
	03h	3st application object	UNSIGNED32	6411 0B 10h
	04h	4st application object	UNSIGNED32	6411 0C 10h
1604h	00h	Number of mapped application objects in RPDO5	UNSIGNED8	08h
	01h	1st application object	UNSIGNED32	6200 09 08h
	02h	2st application object	UNSIGNED32	6200 0A 08h
	03h	3st application object	UNSIGNED32	6200 0B 08h
	04h	4st application object	UNSIGNED32	6200 0C 08h
	05h	5st application object	UNSIGNED32	6200 0D 08h
	06h	6st application object	UNSIGNED32	6200 0E 08h
	07h	7st application object	UNSIGNED32	6200 0F 08h
	08h	8st application object	UNSIGNED32	6200 10 08h
1605h	00h	Number of mapped application objects in RPDO6	UNSIGNED8	04h
	01h	1st application object	UNSIGNED32	6411 0D 10h
	02h	2st application object	UNSIGNED32	6411 0E 10h
	03h	3st application object	UNSIGNED32	6411 0F 10h
	04h	4st application object	UNSIGNED32	6411 10 10h
1606h	00h	Number of mapped application objects in RPDO7	UNSIGNED8	04h
	01h	1st application object	UNSIGNED32	6411 11 10h
	02h	2st application object	UNSIGNED32	6411 12 10h

	03h	3st application object	UNSIGNED32	6411 13 10h
	04h	4st application object	UNSIGNED32	6411 14 10h
1607h	00h	Number of mapped application objects in RPDO8	UNSIGNED8	04h
	01h	1st application object	UNSIGNED32	6411 15 10h
	02h	2st application object	UNSIGNED32	6411 16 10h
	03h	3st application object	UNSIGNED32	6411 17 10h
	04h	4st application object	UNSIGNED32	6411 18 10h
1A00h	00h	Number of mapped application objects in TPDO1	UNSIGNED8	08h
	01h	1st application object	UNSIGNED32	6000 01 08h
	02h	2st application object	UNSIGNED32	6000 02 08h
	03h	3st application object	UNSIGNED32	6000 03 08h
	04h	4st application object	UNSIGNED32	6000 04 08h
	05h	5st application object	UNSIGNED32	6000 05 08h
	06h	6st application object	UNSIGNED32	6000 06 08h
	07h	7st application object	UNSIGNED32	6000 07 08h
	08h	8st application object	UNSIGNED32	6000 08 08h
1A01h	00h	Number of mapped application objects in TPDO2	UNSIGNED8	04h
	01h	1st application object	UNSIGNED32	6401 01 10h
	02h	2st application object	UNSIGNED32	6401 02 10h
	03h	3st application object	UNSIGNED32	6401 03 10h
	04h	4st application object	UNSIGNED32	6401 04 10h
1A02h	00h	Number of mapped application objects in TPDO3	UNSIGNED8	04h
	01h	1st application object	UNSIGNED32	6401 05 10h
	02h	2st application object	UNSIGNED32	6401 06 10h
	03h	3st application object	UNSIGNED32	6401 07 10h
	04h	4st application object	UNSIGNED32	6401 08 10h
1A03h	00h	Number of mapped application objects in TPDO4	UNSIGNED8	04h
	01h	1st application object	UNSIGNED32	6401 09 10h
	02h	2st application object	UNSIGNED32	6401 0A 10h
	03h	3st application object	UNSIGNED32	6401 0B 10h
	04h	4st application object	UNSIGNED32	6401 0C 10h

1A04h	00h	Number of mapped application objects in TPDO5	UNSIGNED8	08h
	01h	1st application object	UNSIGNED32	6000 09 08h
	02h	2st application object	UNSIGNED32	6000 0A 08h
	03h	3st application object	UNSIGNED32	6000 0B 08h
	04h	4st application object	UNSIGNED32	6000 0C 08h
	05h	5st application object	UNSIGNED32	6000 0D 08h
	06h	6st application object	UNSIGNED32	6000 0E 08h
	07h	7st application object	UNSIGNED32	6000 0F 08h
	08h	8st application object	UNSIGNED32	6000 10 08h
1A05h	00h	Number of mapped application objects in TPDO6	UNSIGNED8	04h
	01h	1st application object	UNSIGNED32	6401 0D 10h
	02h	2st application object	UNSIGNED32	6401 0E 10h
	03h	3st application object	UNSIGNED32	6401 0F 10h
	04h	4st application object	UNSIGNED32	6401 10 10h
1A06h	00h	Number of mapped application objects in TPDO7	UNSIGNED8	04h
	01h	1st application object	UNSIGNED32	6401 11 10h
	02h	2st application object	UNSIGNED32	6401 12 10h
	03h	3st application object	UNSIGNED32	6401 13 10h
	04h	4st application object	UNSIGNED32	6401 14 10h
1A07h	00h	Number of mapped application objects in TPDO8	UNSIGNED8	04h
	01h	1st application object	UNSIGNED32	6401 15 10h
	02h	2st application object	UNSIGNED32	6401 16 10h
	03h	3st application object	UNSIGNED32	6401 17 10h
	04h	4st application object	UNSIGNED32	6401 18 10h

Application Parameters (6000h~9FFFh):

Index	Sub-index	Description	Type	Default
6206h	01-40h	Error mode digital output 8-bit (1~512)	UNSIGNED8	FFh
6207h	01-40h	Error value digital output 8-bit (1~512)	UNSIGNED8	00h
6443h	01-40h	Error mode analog output (1~64)	UNSIGNED8	01h

6444h	01-40h	Analog output error value integer (1~64)	INTEGER32	0000 0000h
-------	--------	---	-----------	------------

6.1.12 1014h: COB-ID EMCY

According to DS301, before setting COB-ID for EMCY, Bit31 should be set to 1 (Invalid), otherwise COB-ID cannot be set.

Bit31	Bit30	Bit11	Bit10	Bit0
0/1 (valid/invalid)	Reserved(0)		COB-ID	

6.1.13 1015h: Inhibit Time EMCY

The interval between two EMCY messages must be longer than the Inhibit Time (unit: 100μs). 0 means disabling this function.

6.1.14 1016h: Consumer Heartbeat Time

Consumer Heartbeat Time specifies the interval at which the node receives heartbeat messages in milliseconds (ms). If Heartbeat Time is 0 or Node-ID equals to 0 / greater than 127, no heartbeat message is sent.

Sub-index 00h: Number of word sub-index

Sub-index 01h: Consumer heartbeat time

31	24	23	16	15	0
Reserved (00h)		Node-ID		Heartbeat time	
MSB			LSB		

6.1.15 1017h: Producer Heartbeat Time

Producer Heartbeat Time specifies the interval at which the node sends heartbeat messages (700h+Node-ID) in milliseconds (ms). By default this object is set to 0 which means no heartbeat message is sent.

6.1.16 1029h: Error Behavior Object

When the following communication errors occur:

- CAN Bus-OFF
- Life Guarding Event
- Heartbeat Event

This object can be used to give the following commands:

Error Behavior Object		
Index	Sub Index	Description
1029h	01h	0 : Change to NMT state Pre-operational. (If currently in NMT state Operational) 1 : No change of the NMT state. 2 : Change to NMT state Stopped.

6.2 PDO Communication Parameter

6.2.1 RxPDO Communication Parameter

Index	Sub-index	Description	Type	ro/rw	Default
1400h	00h	Number of sub-index in RPDO1	UNSIGNED8	ro	02h
	01h	COB-ID used by RPDO1	UNSIGNED32	rw	200h + Node-ID
	02h	Transmission type of RPDO1	UNSIGNED8	ro	FFh
1401h	00h	Number of sub-index in RPDO2	UNSIGNED8	ro	02h
	01h	COB-ID used by RPDO2	UNSIGNED32	rw	300h + Node-ID
	02h	Transmission type of RPDO2	UNSIGNED8	ro	FFh
1402h	00h	Number of sub-index in RPDO3	UNSIGNED8	ro	02h
	01h	COB-ID used by RPDO3	UNSIGNED32	rw	400h + Node-ID
	02h	Transmission type of RPDO3	UNSIGNED8	ro	FFh
1403h	00h	Number of sub-index in RPDO4	UNSIGNED8	ro	02h
	01h	COB-ID used by RPDO4	UNSIGNED32	rw	500h + Node-ID
	02h	Transmission type of RPDO4	UNSIGNED8	ro	FFh
1404h	00h	Number of sub-index in RPDO5	UNSIGNED8	ro	02h
	01h	COB-ID used by RPDO5	UNSIGNED32	rw	8000000
	02h	Transmission type of RPDO5	UNSIGNED8	ro	FFh
1405h	00h	Number of sub-index in RPDO6	UNSIGNED8	ro	02h
	01h	COB-ID used by RPDO6	UNSIGNED32	rw	8000000
	02h	Transmission type of RPDO6	UNSIGNED8	ro	FFh
1406h	00h	Number of sub-index in RPDO7	UNSIGNED8	ro	02h
	01h	COB-ID used by RPDO7	UNSIGNED32	rw	8000000
	02h	Transmission type of RPDO7	UNSIGNED8	ro	FFh
1407h	00h	Number of sub-index in RPDO8	UNSIGNED8	ro	02h
	01h	COB-ID used by RPDO8	UNSIGNED32	rw	8000000
	02h	Transmission type of RPDO8	UNSIGNED8	ro	FFh

- Sub-index 01h: COB-ID used by RPDO
Transmission of RxPDO is only possible in NMT state Operational. As shown below, setting Bit31 to 1 disables the function. Each Node-ID supports four RxPDO, to use more than four, please find available Node-ID.

Bit31	Bit30	Bit11	Bit10	Bit0
0/1 (valid/invalid)	Reserved(0)		COB-ID	

- Sub-index 02h: Transmission Type of RPDO
00~F0: synchronous, FEh/FFh: event driven

Value	Description
00 _h	synchronous
.....
F0 _h	synchronous
F1 _h	reserved
.....
FD _h	reserved
FE _h	event-driven (manufacturer-specific)
FF _h	event-driven (device profile and application profile specific)

6.2.2 TxPDO Communication Parameter

Index	Sub-index	Description	Type	ro/rw	Default
1800h	00h	Number of sub-index in TPDO1	UNSIGNED8	ro	05h
	01h	COB-ID used by TPDO1	UNSIGNED32	rw	180h + Node-ID
	02h	Transmission type of TPDO1	UNSIGNED8	ro	FFh
	03h	Inhibit time of TPDO1	UNSIGNED16	rw	0
	05h	Event timer of TPDO1	UNSIGNED16	rw	0
1801h	00h	Number of sub-index in TPDO2	UNSIGNED8	ro	05h
	01h	COB-ID used by TPDO2	UNSIGNED32	rw	280h + Node-ID
	02h	Transmission type of TPDO2	UNSIGNED8	ro	FFh
	03h	Inhibit time of TPDO2	UNSIGNED16	rw	0
	05h	Event timer of TPDO2	UNSIGNED16	rw	0
1802h	00h	Number of sub-index in TPDO3	UNSIGNED8	ro	05h
	01h	COB-ID used by TPDO3	UNSIGNED32	rw	380h + Node-ID
	02h	Transmission type of TPDO3	UNSIGNED8	ro	FFh
	03h	Inhibit time of TPDO3	UNSIGNED16	rw	0
	05h	Event timer of TPDO3	UNSIGNED16	rw	0
1803h	00h	Number of sub-index in TPDO4	UNSIGNED8	ro	05h

	01h	COB-ID used by TPDO4	UNSIGNED32	rw	480h + Node-ID
	02h	Transmission type of TPDO4	UNSIGNED8	ro	FFh
	03h	Inhibit time of TPDO4	UNSIGNED16	rw	0
	05h	Event timer of TPDO4	UNSIGNED16	rw	0
1804h	00h	Number of sub-index in TPDO5	UNSIGNED8	ro	05h
	01h	COB-ID used by TPDO5	UNSIGNED32	rw	8000000
	02h	Transmission type of TPDO5	UNSIGNED8	ro	FFh
	03h	Inhibit time of TPDO5	UNSIGNED16	rw	0
	05h	Event timer of TPDO5	UNSIGNED16	rw	0
1805h	00h	Number of sub-index in TPDO6	UNSIGNED8	ro	05h
	01h	COB-ID used by TPDO6	UNSIGNED32	rw	8000000
	02h	Transmission type of TPDO6	UNSIGNED8	ro	FFh
	03h	Inhibit time of TPDO6	UNSIGNED16	rw	0
	05h	Event timer of TPDO6	UNSIGNED16	rw	0
1806h	00h	Number of sub-index in TPDO7	UNSIGNED8	ro	05h
	01h	COB-ID used by TPDO7	UNSIGNED32	rw	8000000
	02h	Transmission type of TPDO7	UNSIGNED8	ro	FFh
	03h	Inhibit time of TPDO7	UNSIGNED16	rw	0
	05h	Event timer of TPDO7	UNSIGNED16	rw	0
1807h	00h	Number of sub-index in TPDO8	UNSIGNED8	ro	05h
	01h	COB-ID used by TPDO8	UNSIGNED32	rw	8000000
	02h	Transmission type of TPDO8	UNSIGNED8	ro	FFh
	03h	Inhibit time of TPDO8	UNSIGNED16	rw	0
	05h	Event timer of TPDO8	UNSIGNED16	rw	0

- Sub-index 01h: COB-ID used by TPDO
Transmission of TxPDO is only possible in NMT state Operational. As shown below, setting Bit31 to 1 disables the function. Each Node-ID supports four TxPDO, to use more than four, please find available Node-ID.

Bit31	Bit30	Bit11	Bit10	Bit0
0/1 (valid/invalid)	Reserved(always 0)		COB-ID	

- Sub-index 02h: Transmission Type of TPDO
00~F0: synchronous, transmits PDO when the number of SYNC reaches the specified number.
FCh: Transmits PDO after receiving RTR.
FDh: Transmits PDO after receiving RTR and triggering event.
FEh/FFh: Transmits PDO when an event is triggered.

Value	Description
00 _h	synchronous (acyclic)
01 _h	synchronous (cyclic every sync)
02 _h	synchronous (cyclic every 2 nd sync)
03 _h	synchronous (cyclic every 3 rd sync)
04 _h	synchronous (cyclic every 4 th sync)
.....
F0 _h	synchronous (cyclic every 240 th sync)
F1 _h	reserved
.....
FB _h	reserved
FC _h	RTR-only (synchronous)
FD _h	RTR-only (event-driven)
FE _h	event-driven (manufacturer-specific)
FF _h	event-driven (device profile and application profile specific)

- Sub-index 03h: Inhibit Time

When Transmission Type of PDO is set to FEh/FFh, the inhibit time specifies the minimum length of time in 100μs that must be allowed to elapse between the transmissions. 0 means disabling this function.

- Sub-index 05h: Event Timer

When Transmission Type of PDO is set to FEh/FFh, the Event Timer specifies the minimum length of time in milliseconds that must be allowed to elapse between the transmissions. 0 means disabling this function.

6.2.3 PDO Mapping Parameter

Index	Sub-index	Description	Type	ro/ rw	Default
RPDO1 mapping parameter(digital outputs)					
1600h	00h	Number of mapped application objects in RPDO1	UNSIGNED8	rw	08h
	01h	1st application object	UNSIGNED32	rw	6200 01 08h
	02h	2st application object	UNSIGNED32	rw	6200 02 08h
	03h	3st application object	UNSIGNED32	rw	6200 03 08h
	04h	4st application object	UNSIGNED32	rw	6200 04 08h
	05h	5st application object	UNSIGNED32	rw	6200 05 08h
	06h	6st application object	UNSIGNED32	rw	6200 06 08h
	07h	7st application object	UNSIGNED32	rw	6200 07 08h
	08h	8st application object	UNSIGNED32	rw	6200 08 08h

RPDO2 mapping parameter (analog outputs)					
1601h	00h	Number of mapped application objects in PDO	UNSIGNED8	rw	04h
	01h	1st application object	UNSIGNED32	rw	6411 01 10h
	02h	2st application object	UNSIGNED32	rw	6411 02 10h
	03h	3st application object	UNSIGNED32	rw	6411 03 10h
	04h	4st application object	UNSIGNED32	rw	6411 04 10h
RPDO3 mapping parameter (additional analog outputs)					
1602h	00h	Number of mapped application objects in PDO	UNSIGNED8	rw	04h
	01h	1st application object	UNSIGNED32	rw	6411 05 10h
	02h	2st application object	UNSIGNED32	rw	6411 06 10h
	03h	3st application object	UNSIGNED32	rw	6411 07 10h
	04h	4st application object	UNSIGNED32	rw	6411 08 10h
RPDO4 mapping parameter (additional analog outputs)					
1603h	00h	Number of mapped application objects in PDO	UNSIGNED8	rw	04h
	01h	1st application object	UNSIGNED32	rw	6411 09 10h
	02h	2st application object	UNSIGNED32	rw	6411 0A 10h
	03h	3st application object	UNSIGNED32	rw	6411 0B 10h
	04h	4st application object	UNSIGNED32	rw	6411 0C 10h
RPDO5 mapping parameter(digital outputs)					
1605h	00h	Number of mapped application objects in PDO	UNSIGNED8	rw	08h
	01h	1st application object	UNSIGNED32	rw	6200 09 08h
	02h	2st application object	UNSIGNED32	rw	6200 0A 08h
	03h	3st application object	UNSIGNED32	rw	6200 0B 08h
	04h	4st application object	UNSIGNED32	rw	6200 0C 08h
	05h	5st application object	UNSIGNED32	rw	6200 0D 08h
	06h	6st application object	UNSIGNED32	rw	6200 0E 08h
	07h	7st application object	UNSIGNED32	rw	6200 0F 08h
	08h	8st application object	UNSIGNED32	rw	6200 10 08h
RPDO6 mapping parameter (additional analog outputs)					
1606h	00h	Number of mapped application objects in PDO	UNSIGNED8	rw	04h
	01h	1st application object	UNSIGNED32	rw	6411 0D 10h

	02h	2st application object	UNSIGNED32	rw	6411 0E 10h
	03h	3st application object	UNSIGNED32	rw	6411 0F 10h
	04h	4st application object	UNSIGNED32	rw	6411 10 10h
RPDO7 mapping parameter (additional analog outputs)					
1607h	00h	Number of mapped application objects in PDO	UNSIGNED8	rw	04h
	01h	1st application object	UNSIGNED32	rw	6411 11 10h
	02h	2st application object	UNSIGNED32	rw	6411 12 10h
	03h	3st application object	UNSIGNED32	rw	6411 13 10h
	04h	4st application object	UNSIGNED32	rw	6411 14 10h
RPDO8 mapping parameter (additional analog outputs)					
1608h	00h	Number of mapped application objects in PDO	UNSIGNED8	rw	04h
	01h	1st application object	UNSIGNED32	rw	6411 15 10h
	02h	2st application object	UNSIGNED32	rw	6411 16 10h
	03h	3st application object	UNSIGNED32	rw	6411 17 10h
	04h	4st application object	UNSIGNED32	rw	6411 18 10h
TxPDO communication parameter					
1800h	01h	COB-ID used by TPDO1	UNSIGNED32	rw	180h + Node-ID
1801h	01h	COB-ID used by TPDO2	UNSIGNED32	rw	280h + Node-ID
1802h	01h	COB-ID used by TPDO3	UNSIGNED32	rw	380h + Node-ID
1803h	01h	COB-ID used by TPDO4	UNSIGNED32	rw	480h + Node-ID
1804h	01h	COB-ID used by TPDO5	UNSIGNED32	rw	8000000h
1805h	01h	COB-ID used by TPDO6	UNSIGNED32	rw	8000000h
1806h	01h	COB-ID used by TPDO7	UNSIGNED32	rw	8000000h
1807h	01h	COB-ID used by TPDO8	UNSIGNED32	rw	8000000h
TPDO1 mapping parameter(digital inputs)					
1A00h	00h	Number of mapped application objects in TPDO1	UNSIGNED8	rw	08h
	01h	1st application object	UNSIGNED32	rw	6000 01 08h
	02h	2st application object	UNSIGNED32	rw	6000 02 08h
	03h	3st application object	UNSIGNED32	rw	6000 03 08h

	04h	4st application object	UNSIGNED32	rw	6000 04 08h
	05h	5st application object	UNSIGNED32	rw	6000 05 08h
	06h	6st application object	UNSIGNED32	rw	6000 06 08h
	07h	7st application object	UNSIGNED32	rw	6000 07 08h
	08h	8st application object	UNSIGNED32	rw	6000 08 08h
TPDO2 mapping parameter (analog inputs)					
1A01h	00h	Number of mapped application objects in PDO	UNSIGNED8	rw	04h
	01h	1st application object	UNSIGNED32	rw	6401 01 10h
	02h	2st application object	UNSIGNED32	rw	6401 02 10h
	03h	3st application object	UNSIGNED32	rw	6401 03 10h
	04h	4st application object	UNSIGNED32	rw	6401 04 10h
TPDO3 mapping parameter (additional analog inputs)					
1A02h	00h	Number of mapped application objects in PDO	UNSIGNED8	rw	04h
	01h	1st application object	UNSIGNED32	rw	6401 05 10h
	02h	2st application object	UNSIGNED32	rw	6401 06 10h
	03h	3st application object	UNSIGNED32	rw	6401 07 10h
	04h	4st application object	UNSIGNED32	rw	6401 08 10h
TPDO4 mapping parameter (additional analog inputs)					
1A03h	00h	Number of mapped application objects in PDO	UNSIGNED8	rw	04h
	01h	1st application object	UNSIGNED32	rw	6401 09 10h
	02h	2st application object	UNSIGNED32	rw	6401 0A 10h
	03h	3st application object	UNSIGNED32	rw	6401 0B 10h
	04h	4st application object	UNSIGNED32	rw	6401 0C 10h
TPDO5 mapping parameter (digital inputs)					
1A04h	00h	Number of mapped application objects in PDO	UNSIGNED8	rw	08h
	01h	1st application object	UNSIGNED32	rw	6000 09 08h
	02h	2st application object	UNSIGNED32	rw	6000 0A 08h
	03h	3st application object	UNSIGNED32	rw	6000 0B 08h
	04h	4st application object	UNSIGNED32	rw	6000 0C 08h
	05h	5st application object	UNSIGNED32	rw	6000 0D 08h
	06h	6st application object	UNSIGNED32	rw	6000 0E 08h
	07h	7st application object	UNSIGNED32	rw	6000 0F 08h

	08h	8st application object	UNSIGNED32	rw	6000 10 08h
TPDO6 mapping parameter (additional analog outputs)					
1A05h	00h	Number of mapped application objects in PDO	UNSIGNED8	rw	04h
	01h	1st application object	UNSIGNED32	rw	6401 0D 10h
	02h	2st application object	UNSIGNED32	rw	6401 0E 10h
	03h	3st application object	UNSIGNED32	rw	6401 0F 10h
	04h	4st application object	UNSIGNED32	rw	6401 10 10h
TPDO7 mapping parameter (additional analog outputs)					
1A06h	00h	Number of mapped application objects in PDO	UNSIGNED8	rw	04h
	01h	1st application object	UNSIGNED32	rw	6401 11 10h
	02h	2st application object	UNSIGNED32	rw	6401 12 10h
	03h	3st application object	UNSIGNED32	rw	6401 13 10h
	04h	4st application object	UNSIGNED32	rw	6401 14 10h
TPDO8 mapping parameter (additional analog outputs)					
1A07h	00h	Number of mapped application objects in PDO	UNSIGNED8	rw	04h
	01h	1st application object	UNSIGNED32	rw	6401 15 10h
	02h	2st application object	UNSIGNED32	rw	6401 16 10h
	03h	3st application object	UNSIGNED32	rw	6401 17 10h
	04h	4st application object	UNSIGNED32	rw	6401 18 10h

6.2.4 Mapping Parameter

Sub Index 00h:

Value	Description
00h	Mapping disabled
01h	Sub-index 01h valid
....
08h	Sub-index 01-08h valid

Sub Index 01h ~08h:

31	16	15	8	7	0
Index		Sub-index		Length	
MSB			LSB		

6.3 I/O Device Object Dictionary

6.3.1 Read Digital Input

Index	Sub-index	Description	Type	ro/rw	Default
-------	-----------	-------------	------	-------	---------

6000h		Read digital input (8-bit)			
	00h	Number of Digital inputs	UNSIGNED8	ro	40h
	01h	Read input 001h to 008h	UNSIGNED8	ro	----
			
	40h	Read input 1F8h to 200h	UNSIGNED8	ro	----
6020h		Read digital input (1-bit)			
	00h	Number of Digital inputs	UNSIGNED8	ro	80h
	01~80h	Read input 001h~080h	UNSIGNED8	ro	0
6021h		Read digital input (1-bit)			
	00h	Number of Digital inputs	UNSIGNED8	ro	80h
	01~80h	Read input 081h~0FFh	UNSIGNED8	ro	0
6021h		Read digital input (1-bit)			
	00h	Number of Digital inputs	UNSIGNED8	ro	80h
	01~80h	Read input 100h~180h	UNSIGNED8	ro	0
6022h		Read digital input (1-bit)			
	00h	Number of Digital inputs	UNSIGNED8	ro	80h
	01~80h	Read input 181h~1FFh	UNSIGNED8	ro	0
6100h		Read digital input (16-bit)			
	00h	Number of Digital inputs	UNSIGNED8	ro	20h
	01h	Read input 001h to 010h	UNSIGNED16	ro	----
			
	20h	Read input 1F0h to 200h	UNSIGNED16	ro	----
6120h		Read digital input (32-bit)			
	00h	Number of Digital inputs	UNSIGNED8	ro	10h
	01h	Read input 001h to 020h	UNSIGNED32	ro	----
			
	10h	Read input 1E0h to 200h	UNSIGNED32	ro	----

6.3.2 Write Digital Output

Index	Sub-index	Description	Type	ro/rw	Default
6200h		Write digital output (8-bit)			
	00h	Number of Digital outputs	UNSIGNED8	ro	40h
	01h	Write output 001h to 008h	UNSIGNED8	ro	----
			
	40h	Write output 1F8h to 200h	UNSIGNED8	ro	0
6220h		Write digital output (1-bit)			
	00h	Number of Digital outputs	UNSIGNED8	ro	80h
	01~80h	Write output 001h~080h	UNSIGNED8	ro	0
6221h		Write digital output (1-bit)			
	00h	Number of Digital outputs	UNSIGNED8	ro	80h
	01~80h	Write output 081h~0FFh	UNSIGNED8	ro	0
6222h		Write digital output (1-bit)			
	00h	Number of Digital outputs	UNSIGNED8	ro	80h
	01~80h	Write output 100h~180h	UNSIGNED8	ro	0
6223h		Write digital output (1-bit)			
	00h	Number of Digital outputs	UNSIGNED8	ro	80h
	01~80h	Write output 181h~1FFh	UNSIGNED8	ro	0
6300h		Write digital output (16-bit)			
	00h	Number of Digital outputs	UNSIGNED8	ro	20h
	01h	Write output 001h to 010h	UNSIGNED16	ro	0
			
	20h	Write output 1F0h to 200h	UNSIGNED16	ro	0
6320h		Write digital output (32-bit)			
	00h	Number of Digital outputs	UNSIGNED8	ro	10h
	01h	Write output 001h to 020h	UNSIGNED32	ro	0
			
	10h	Write output 1E0h to 200h	UNSIGNED32	ro	0

6.3.3 Read Analog Input

Index	Sub-index	Description	Type	ro/rw	Default
6401h		Read analog input (16-bit)			
	00h	Number of analog input	UNSIGNED8	ro	40h
	01h	Value of channel 01	INTEGER16	ro	0
			
	40h	Value of channel 64	INTEGER16	ro	0

6.3.4 Write Analog Output

Index	Sub-index	Description	Type	ro/rw	Default
6411h		Write analog output 16-bit			
	00h	Number of analog output	UNSIGNED8	rw	40h
	01h	Value of channel 01	INTEGER16	rw	0
			
	40h	Value of channel 64	INTEGER16	rw	0

6.4 Manufacturer-specific Profile Area

6.4.1 2000h~2001h: Digital Input Filter

Index	Sub-index	Description	Type	ro/rw	Default
2000h	00h	Number of digital input	UNSIGNED8	ro	FFh
	01-FFh	Digital input 1-255 filter time	UNSIGNED16	rw	0000h
2001h	00h	Number of digital input	UNSIGNED8	ro	FFh
	01-FFh	Digital input 1-255 filter time	UNSIGNED16	rw	0000h

6.4.2 3000h~300Fh: Module Registers

Index	Description
3000h	Read/write the 1st module register.
3001h	Read/write the 2nd module register.
3002h	Read/write the 3rd module register.
3003h	Read/write the 4th module register.
3004h	Read/write the 5th module register.
3005h	Read/write the 6th module register.
3006h	Read/write the 7th module register.
.....
300Fh	Read/write the 16th module register.

Sub-index	Description	Type	ro/rw	Default
00h	Number of digital inputs	UNSIGNED8	ro	80h
01h	Module register address 0	UNSIGNED16	rw	
02h	Module register address 1	UNSIGNED16	rw	
03h	Module register address 2	UNSIGNED16	rw	
04h	Module register address 3	UNSIGNED16	rw	
.....
80h	Module register address 127	UNSIGNED16	rw	

6.4.3 4000h~4007h: iBus and Module Information

Index	Sub-index	Description	Type	ro/rw	Default
4000h	00h	Number of connected modules.	UNSIGNED16	ro	----
	01h	Reserved	UNSIGNED16	ro	----
	02h	Number of digital inputs.	UNSIGNED16	ro	----
	03h	Number of digital outputs.	UNSIGNED16	ro	----
	04h	Number of analog inputs.	UNSIGNED16	ro	----
	05h	Number of analog outputs.	UNSIGNED16	ro	----
	06h	Total power consumption.	UNSIGNED16	ro	----
	07h	Supported power consumption.	UNSIGNED16	ro	----
4001h	01h	Firmware version of the 1 st module.	UNSIGNED16	ro	----
	02h	Firmware version of the 2 nd module.	UNSIGNED16	ro	----

	10h	Firmware version of the 16 th module.	UNSIGNED16	ro	----
4002h	01h	Hardware version of the 1 st module.	UNSIGNED16	ro	----
	02h	Hardware version of the 2 nd module.	UNSIGNED16	ro	----

	10h	Hardware version of the 16 th module.	UNSIGNED16	ro	----
4003h	01h	Power consumption of the 1 st module.	UNSIGNED16	ro	----
	02h	Power consumption of the 2 nd module.	UNSIGNED16	ro	----

	10h	Power consumption of the 16 th module.	UNSIGNED16	ro	----
4004h	01h	Number of digital inputs of the 1 st module.	UNSIGNED16	ro	----
	02h	Number of digital inputs of the 2 nd module.	UNSIGNED16	ro	----

	10h	Number of digital inputs of the 16 th module.	UNSIGNED16	ro	----

4005h	01h	Number of digital outputs of the 1 st module.	UNSIGNED16	ro	
	02h	Number of digital outputs of the 2 nd module.	UNSIGNED16	ro	
	
	10h	Number of digital outputs of the 16 th module.	UNSIGNED16	ro	
4006h	01h	Number of analog input channels of the 1 st module.	UNSIGNED16	ro	
	02h	Number of analog input channels of the 2 nd module.	UNSIGNED16	ro	
	
	10h	Number of analog input channels of the 16 th module.	UNSIGNED16	ro	
4007h	01h	Number of analog output channels of the 1 st module.	UNSIGNED16	ro	
	02h	Number of analog output channels of the 2 nd module.	UNSIGNED16	ro	
	
	10h	Number of analog output channels of the 16 th module.	UNSIGNED16	ro	

7 Power Consumption

I/O modules use system power supply and external drive power supply, and these two types of power supply should be calculated separately. Operating coupler and module requires system power supply while switching I/O and driver requires external power supply. When calculating power consumption for coupler, the power needed for the connected modules should be put into the equation. Please consider power requirements while connecting multiple modules. The following tables show references on power consumption of couplers and modules.

Type	Device	Consumption(5V)	Power Supply(5V)
Coupler	iR-ETN	220mA/1.1w	2A/10w
	iR-COP	170mA/0.85w	2A/10w
Digital I/O	iR-DM16-P	130mA/0.65w	--
	iR-DM16-N	130mA/0.65w	--
	iR-DQ08-R	220mA/1.1w	--
	iR-DQ16-N	205mA/1.02w	
	iR-DQ16-P	196mA/0.984w	
	iR-DI16-K	83mA/0.418w	

Analog I/O	iR-AQ04-VI	55mA/0.275w	--
	iR-AI04-VI	70mA/0.35W	--
	iR-AM06-VI	70mA/0.35W	--
	iR-AI04-TR	65mA/0.325w	--
Motion Control	iR-PU01-P	108mA/0.54W	

Note:

The coupler is the only power supply for the modules in this system. Please consider power requirements when connecting multiple modules.

Example:

Device	Name	Consumption	Power Supply
Coupler	iR-COP	170mA/0.85w	2A/10w
Module	iR-DQ08-R *8	220mA*8=1.76A	X
System	Power consumption : 170mA + 1.76A = 1.93 A Power supply: 2A > 1.93A		

8 Connecting Remote I/O using CODESYS

See cMT+CODESYS and Remote I/O manuals.

9 Configuring Analog Modules in CODESYS

Analog modules connected to iR-COP can be configured in the following two ways.

Way1. Add SDO and then log in to write the parameters.

Way2. Use Weintek_Library Function Block that can read or write values to the designated addresses.

9.1 Add SDO

[iR-COP] » [SDOs] » [Add SDO]

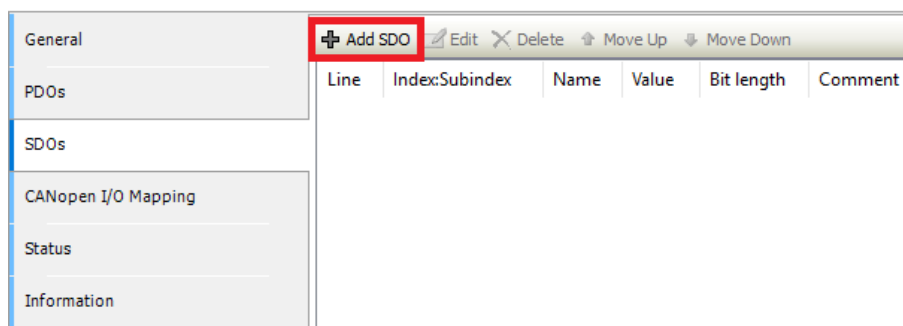

Add SDO and then log in the program. Parameters will be written to modules after login.

9.1.1 Write Analog Input

Index = 16#3001 (In this demonstration, the analog module is the second module in the system.)

Sub Index = 16#15 (Channel mode of Analog Input’s channel 0. Please see iR-AI04-VI, iR-AM06-VI, iR-AQ04-VI User Manual for more information on module registers.)

Bit length = 16 (The length for all registers is 16-bit)

Value = 1 (Write value, please see iR-AI04-VI, iR-AM06-VI, iR-AQ04-VI User Manual for more information on module registers.)

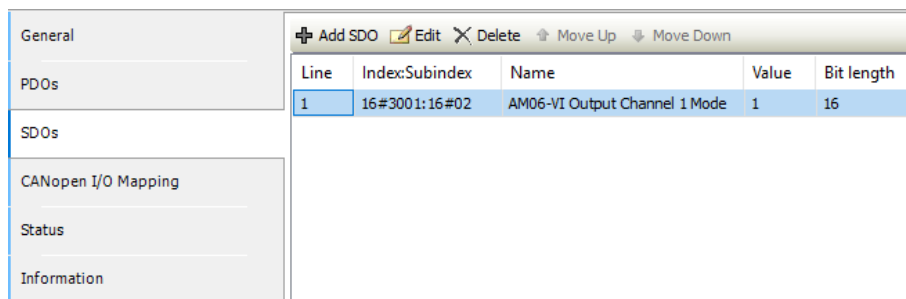
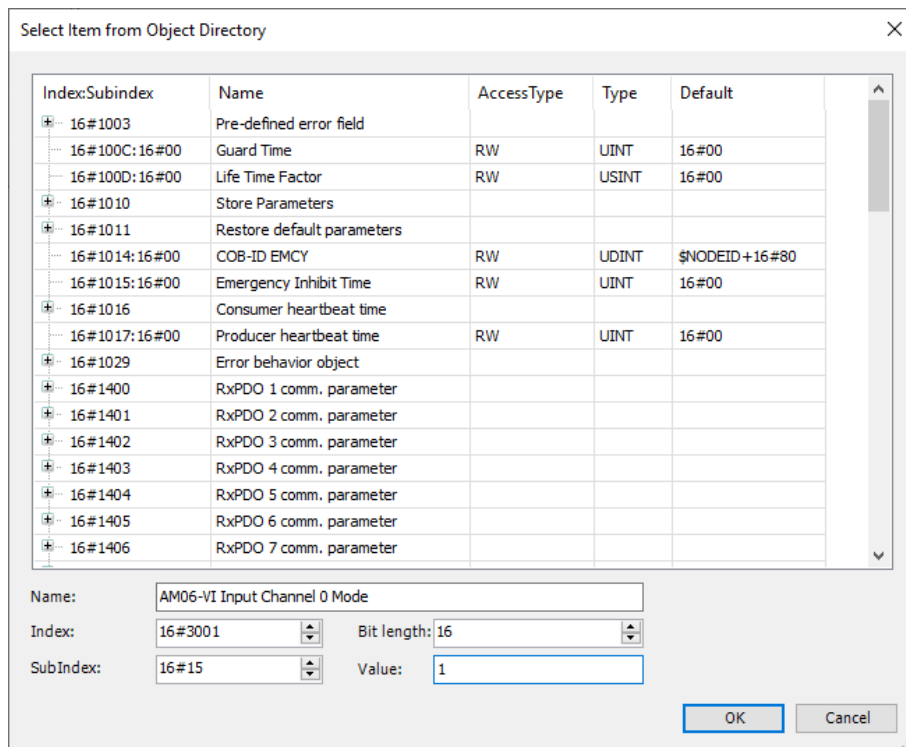

9.1.2 Write Analog Output

Index = 16#3001 (In this demonstration, the analog module is the second module in the system.)

Sub Index = 16#02 (Channel mode of Analog Output’s channel 1. Please see iR-AI04-VI, iR-AM06-VI, iR-AQ04-VI User Manual for more information on module registers.)

Bit length = 16 (The length for all registers is 16-bit)

Value = 1 (Write value, please see iR-AI04-VI, iR-AM06-VI, iR-AQ04-VI User Manual for more information on module registers.)

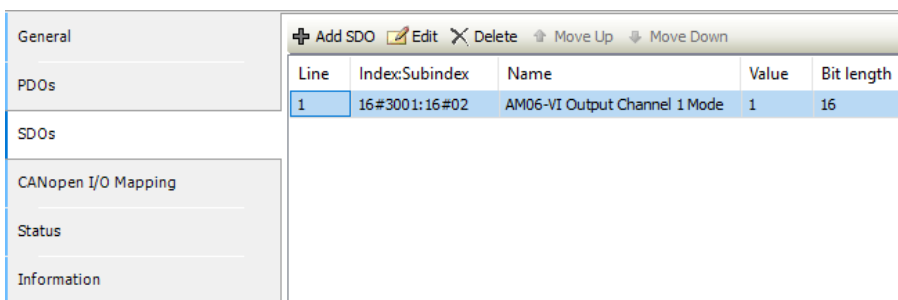
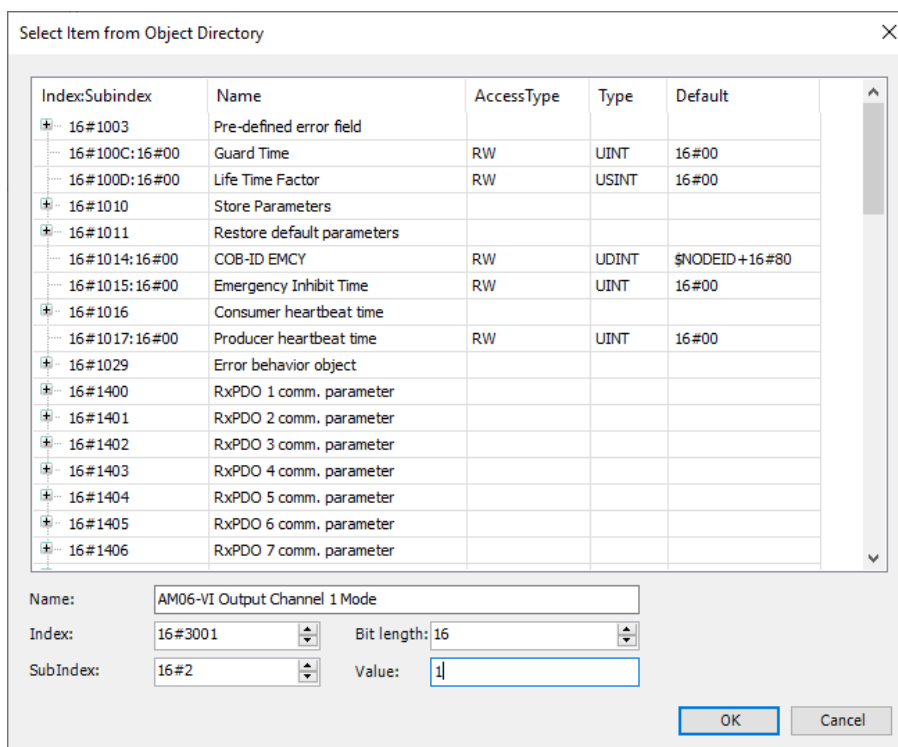

9.1.3 Write Temperature Input

Index = 16#3000 (In this demonstration, the analog module is the first module in the system.)

Sub Index = 16#01 (Channel mode of Temperature Input’s channel 0. Please see iR-AI04-TR User Manual for more information on module registers.)

Bit length = 16 (The length for all registers is 16-bit)

Value = 1 (Write value; please see iR-AI04-TR User Manual for more information on module registers.)

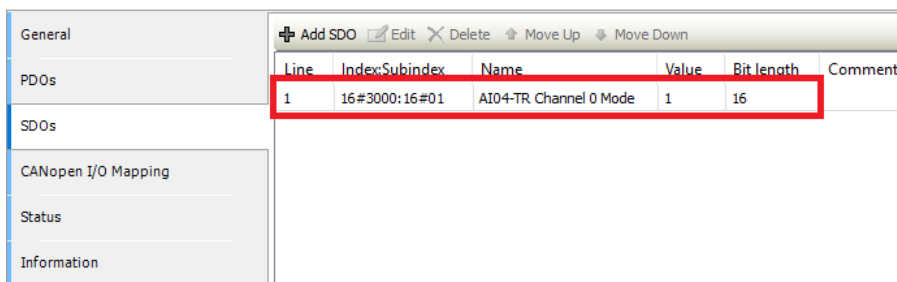
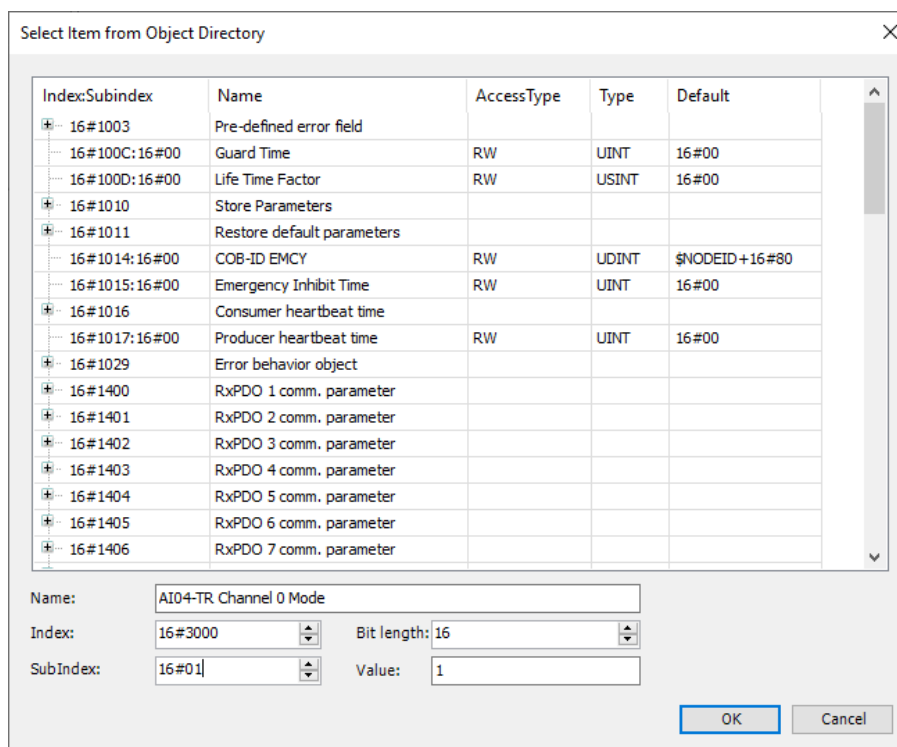

9.2 Weintek_Library Function Block

[Library Manager] » [Add library] » [Miscellaneous] » [Weintek CODESYS Library]

The following four Function Blocks can read from and write to the Analog module connected to iR-COP: AI_Ch_Pa, Analog_Config, Analog_VI_Read, AO_Ch_Pa

9.2.1 Analog_Config – Read/Write a Single Register

xEnable = Rising Edge, read/write parameters according to the settings of

xRead_Write, wIndex, bSubIndx, bNode_ID

xRead_Write = Read or write.

wIndex = Index of the module.

bSubIndx = Register function, please see iR-AI04-VI, iR-AM06-VI, iR-AQ04-VI User Manual for more information on module registers.

bNode_ID = Node of iR-COP.

xConfirm = Execution finished.

iData = Data being read or written.

Example:

Read the first module's (iR-AI04-TR) channel 0.

Declaration:

```

1 | PROGRAM PLC_PRG
2 | VAR
3 |     Analog_Register_Config : weintek.Analog_Config ;
4 |     xEnable : BOOL ;
5 |     xRead_Write_Switch : BOOL;
6 |     wIndex : WORD ;
7 |     bSub_Index : BYTE ;
8 |     bNode_ID : BYTE ;
9 |     xConfirm : BOOL ;
10|     iRegister_Data : INT ;

```

Enter the addresses.

Device.Application.PLC_PRG			
Expression	Type	Value	Prepared value
⊕ Analog_Register_Config	weintek.Analog_Config		
⊕ xEnable	BOOL	FALSE	
⊕ xRead_Write_Switch	BOOL	FALSE	
⊕ wIndex	WORD	16#0000	16#3000
⊕ bSub_Index	BYTE	16#00	16#01
⊕ bNode_ID	BYTE	16#00	16#01
⊕ xConfirm	BOOL	FALSE	
⊕ iRegister_Data	INT	16#0000	

```

1 | Analog_Register_Config (
2 |     xEnable FALSE := xEnable FALSE ,
3 |     xRead_Write FALSE := xRead_Write_Switch FALSE ,
4 |     wIndex 16#0000 := wIndex 16#0000 <16#3000> ,
5 |     bSubIndex 16#00 := bSub_Index 16#00 <16#01> ,
6 |     bNode_ID 16#00 := bNode_ID 16#00 <16#01> ,
7 |     xConfirm FALSE => xConfirm FALSE ,
8 |     iData 16#0000 := iRegister_Data 16#0000 ) ; RETURN

```

Trigger xEnable to read the value displayed in iRegister_Data.

Expression	Type	Value
+	◆ Analog_Register_Config	weintek.Analog_Config
	◆ xEnable	BOOL TRUE
	◆ xRead_Write_Switch	BOOL FALSE
	◆ wIndex	WORD 16#3000
	◆ bSub_Index	BYTE 16#01
	◆ bNode_ID	BYTE 16#01
	◆ xConfirm	BOOL TRUE
	◆ iRegister_Data	INT 16#0001

```

1 Analog_Register_Config(
2     xEnable TRUE := xEnable FALSE TRUE,
3     xRead_Write FALSE := xRead_Write_Switch FALSE,
4     wIndex 16#3000 := wIndex FALSE 16#3000,
5     bSubIndex 16#01 := bSub_Index FALSE 16#01,
6     bNode_ID 16#01 := bNode_ID FALSE 16#01,
7     xConfirm TRUE => xConfirm TRUE,
8     iData 16#0001 := iRegister_Data 16#0001 ); RETURN

```

The value in iRegister_Data is 1 (J-Type)

Please note the when xRead_Write_Switch = TRUE, then triggering xEnable is to write instead of to read.

9.2.2 AI_Ch_Pa – Read/Write the Channel of Analog Input

xEnable = Rising Edge, read/write parameters according to the settings of xRead_Write, wIndex, bSubIndx, bNode_ID

xRead_Write = Read or write.

bNode_ID = Node of iR-COP.

wIndex = Index of the module.

bChannel = Operate channel (0-3).

xDone = Execution finished.

iMax_peak, iMin_peak, iMode, iScale_Max, iScale_Min, iSamp_times = Channel parameters of Analog Input.

Example:

Read the second module's (iR-AM06-VI) channel 0.

Declaration:

```

2  VAR
3      AI_Config_Ch : weintek.AI_Ch_Pa ;
4      xEnable : BOOL ;
5      xRead_Write_Switch : BOOL;
6      bNode_ID : BYTE ;
7      wIndex : WORD ;
8      bChannel : BYTE ;
9      xDone : BOOL ;
10     iMax_peak : INT ;
11     iMin_peak : INT ;
12     iMode : INT ;
13     iScale_Max : INT ;
14     iScale_Min : INT ;
15     iFilter_Frame_Size : INT ;

```

Enter the addresses.

Expression	Type	Value
AI_Config_Ch	weintek.AI_Ch_Pa	
xEnable	BOOL	FALSE
xRead_Write_Switch	BOOL	FALSE
bNode_ID	BYTE	F 16#01
wIndex	WORD	F 16#3001
bChannel	BYTE	F 16#00
xDone	BOOL	FALSE
iMax_peak	INT	16#0000
iMin_peak	INT	16#0000
iMode	INT	16#0000
iScale_Max	INT	16#0000
iScale_Min	INT	16#0000
iFilter_Frame_Size	INT	16#0000

```

1  AI_Config_Ch(
2      xEnable FALSE := xEnable FALSE ,
3      xRead_Write FALSE := xRead_Write_Switch FALSE ,
4      bNode_ID 16#01 := bNode_ID F 16#01 ,
5      bChannel 16#00 := bChannel F 16#00 ,
6      wIndex 16#3001 := wIndex F 16#3001 ,
7      xDone FALSE => xDone FALSE ,
8      iMax_peak 16#0000 => iMax_peak 16#0000 ,
9      iMin_peak 16#0000 => iMin_peak 16#0000 ,
10     iMode 16#0000 := iMode 16#0000 ,
11     iScale_Max 16#0000 := iScale_Max 16#0000 ,
12     iScale_Min 16#0000 := iScale_Min 16#0000 ,
13     iSamp_times 16#0000 := iFilter_Frame_Size 16#0000 ) ;
14  RETURN

```

Trigger xEnable to read channel parameter.

Expression	Type	Value
AI_Config_Ch	weintek.AI_Ch_Pa	
xEnable	BOOL	TRUE
xRead_Write_Switch	BOOL	FALSE
bNode_ID	BYTE	16#01
wIndex	WORD	16#3001
bChannel	BYTE	16#00
xDone	BOOL	TRUE
iMax_peak	INT	16#0000
iMin_peak	INT	16#FFA8
iMode	INT	16#0001
iScale_Max	INT	16#7D00
iScale_Min	INT	16#8300
iFilter_Frame_Size	INT	16#0005

```

1 AI_Config_Ch (
2   xEnable TRUE := xEnable TRUE,
3   xRead_Write_SWITCH FALSE := xRead_Write_Switch FALSE,
4   bNode_ID 16#01 := bNode_ID 16#01,
5   bChannel 16#00 := bChannel 16#00,
6   wIndex 16#3001 := wIndex 16#3001,
7   xDone TRUE => xDone TRUE,
8   iMax_peak 16#0000 => iMax_peak 16#0000,
9   iMin_peak 16#FFA8 => iMin_peak 16#FFA8,
10  iMode 16#0001 := iMode 16#0001,
11  iScale_Max 16#7D00 := iScale_Max 16#7D00,
12  iScale_Min 16#8300 := iScale_Min 16#8300,
13  iSamp_times 16#0005 := iFilter_Frame_Size 16#0005 );
14 RETURN

```

The value in the channel is read.

Please note the when xRead_Write_Switch = TRUE, then triggering xEnable is to write instead of to read.

9.2.3 AO_Ch_Pa – Read/Write the Channel of Analog Output

xEnable = Rising Edge, read/write parameters according to the settings of

xRead_Write, wIndex, bSubIndx, bNode_ID

xRead_Write = Read or write.

bNode_ID = Node of iR-COP.

wIndex = Index of the module.

bChannel = Operate channel (0-3).

xDone = Execution finished.

iMode, iScale_Max, iScale_Min, iUpdate_times = Channel parameters of Analog Output.

Example:

Read the second module's (iR-AM06-VI) channel 0.

Declaration:

```

1  PROGRAM PLC_PRG
2  VAR
3      AQ_Config_Ch : weintek.AO_Ch_Pa ;
4      xEnable : BOOL ;
5      xRead_Write_Switch : BOOL;
6      bNode_ID : BYTE ;
7      wIndex : WORD ;
8      bChannel : BYTE ;
9      xDone : BOOL ;
10     iMode : INT ;
11     iScale_Max : INT ;
12     iScale_Min : INT ;
13     iUpdate_time : INT ;

```

Enter the addresses.

Expression	Type	Value
⊕ AQ_Config_Ch	weintek.AO_Ch_Pa	
◆ xEnable	BOOL	FALSE
◆ xRead_Write_Switch	BOOL	FALSE
◆ bNode_ID	BYTE	F 16#01
◆ wIndex	WORD	F 16#3001
◆ bChannel	BYTE	F 16#01
◆ xDone	BOOL	FALSE
◆ iMode	INT	16#0000
◆ iScale_Max	INT	16#0000
◆ iScale_Min	INT	16#0000
◆ iUpdate_time	INT	16#0000

```

1  AQ_Config_Ch(
2      xEnable FALSE := xEnable FALSE ,
3      xRead_Write FALSE := xRead_Write_Switch FALSE ,
4      bNode_ID 16#01 := bNode_ID F 16#01 ,
5      wIndex 16#3001 := wIndex F 16#3001 ,
6      bChannel 16#01 := bChannel F 16#01 ,
7      xDone FALSE => xDone FALSE ,
8      iMode 16#0000 := iMode 16#0000 ,
9      iScale_Max 16#0000 := iScale_Max 16#0000 ,
10     iScale_Min 16#0000 := iScale_Min 16#0000 ,
11     iUpdate_time 16#0000 := iUpdate_time 16#0000 );
12  RETURN

```

Trigger xEnable to read channel parameter.

Expression	Type	Value
⊕ AQ_Config_Ch	weintek.AO_Ch_Pa	
xEnable	BOOL	F TRUE
xRead_Write_Switch	BOOL	FALSE
bNode_ID	BYTE	F 16#01
wIndex	WORD	F 16#3001
bChannel	BYTE	F 16#01
xDone	BOOL	TRUE
iMode	INT	16#0001
iScale_Max	INT	16#7D00
iScale_Min	INT	16#8300
iUpdate_time	INT	16#0000

```

1  AQ_Config_Ch(
2      xEnable TRUE := xEnable F TRUE,
3      xRead_Write FALSE := xRead_Write_Switch FALSE,
4      bNode_ID 16#01 := bNode_ID F 16#01,
5      wIndex 16#3001 := wIndex F 16#3001,
6      bChannel 16#01 := bChannel F 16#01,
7      xDone TRUE => xDone TRUE,
8      iMode 16#0001 := iMode 16#0001,
9      iScale_Max 16#7D00 := iScale_Max 16#7D00,
10     iScale_Min 16#8300 := iScale_Min 16#8300,
11     iUpdate_time 16#0000 := iUpdate_time 16#0000 );
12  RETURN

```

The value in the channel is read.

Please note the when xRead_Write_Switch = TRUE, then triggering xEnable is to write instead of to read.

9.2.4 Analog_VI_Read – Read all Registers of Analog Module

xEnable = Rising Edge, read/write parameters according to the settings of wIndex, bNode_ID

bNode_ID = Node of iR-COP.

wIndex = Index of the module.

xDone = Execution finished.

aiRegister = All registers of Analog module.

Example:

Read all the parameters in the second module's (iR-AM06-VI) channel 0.

Declaration:

```

1 PROGRAM PLC_PRG
2 VAR
3     Analog_Register_Read : weintek.Analog_VI_Read ;
4     xEnable : BOOL ;
5     bNode_ID : BYTE ;
6     wIndex : WORD ;
7     xDone : BOOL ;
8     aiRegister : ARRAY[0..43] OF INT ;

```

Enter the addresses.

Expression	Type	Value
⊕ Analog_Register_Read	weintek.Analog_VI_...	
xEnable	BOOL	FALSE
bNode_ID	BYTE	F 16#01
wIndex	WORD	F 16#3000
xDone	BOOL	FALSE
⊖ aiRegister	ARRAY [0..43] OF INT	
aiRegister[0]	INT	16#0000
aiRegister[1]	INT	16#0000
aiRegister[2]	INT	16#0000
aiRegister[3]	INT	16#0000
aiRegister[4]	INT	16#0000
aiRegister[5]	INT	16#0000
aiRegister[6]	INT	16#0000
aiRegister[7]	INT	16#0000
aiRegister[8]	INT	16#0000
aiRegister[9]	INT	16#0000
aiRegister[10]	INT	16#0000
aiRegister[11]	INT	16#0000
aiRegister[12]	INT	16#0000
aiRegister[13]	INT	16#0000
aiRegister[14]	INT	16#0000
aiRegister[15]	INT	16#0000
aiRegister[16]	INT	16#0000
aiRegister[17]	INT	16#0000
aiRegister[18]	INT	16#0000
aiRegister[19]	INT	16#0000
aiRegister[20]	INT	16#0000

```

1 Analog_Register_Read(
2     xEnable FALSE := xEnable FALSE,
3     bNode_ID 16#01 := bNode_ID F 16#01,
4     wIndex 16#3000 := wIndex F 16#3000,
5     xDone FALSE => xDone FALSE,
6     aiRegister => aiRegister);

```

Trigger xEnable to read channel parameter.

Expression	Type	Value
⊕ Analog_Register_Read	weintek.Analog_VI_...	
xEnable	BOOL	F TRUE
bNode_ID	BYTE	F 16#01
wIndex	WORD	F 16#3000
xDone	BOOL	TRUE
⊖ aiRegister	ARRAY [0..43] OF INT	
aiRegister[0]	INT	16#0002
aiRegister[1]	INT	16#0003
aiRegister[2]	INT	16#0004
aiRegister[3]	INT	16#0005
aiRegister[4]	INT	16#7D00
aiRegister[5]	INT	16#7D00
aiRegister[6]	INT	16#7D00
aiRegister[7]	INT	16#7D00
aiRegister[8]	INT	16#8300
aiRegister[9]	INT	16#0000
aiRegister[10]	INT	16#8300
aiRegister[11]	INT	16#0000
aiRegister[12]	INT	16#0000
aiRegister[13]	INT	16#0000
aiRegister[14]	INT	16#0000
aiRegister[15]	INT	16#0000
aiRegister[16]	INT	16#0000
aiRegister[17]	INT	16#0000
aiRegister[18]	INT	16#0000
aiRegister[19]	INT	16#0000
aiRegister[20]	INT	16#0001

```

1 Analog_Register_Read(
2   xEnable TRUE := xEnable F TRUE,
3   bNode_ID 16#01 := bNode_ID F 16#01,
4   wIndex 16#3000 := wIndex F 16#3000,
5   xDone TRUE => xDone TRUE,
6   aiRegister=> aiRegister);

```

All parameters are read.

Appendix 1. Resources

For more information on cMT+CODESYS and iR Remote I/O, please see:

[UM018016E_CODESYS_iR_Resources](#)