

---

**iCAM-771**  
**5MP + 360/180° Panoramic View**  
**IR Fisheye Network Camera**

---

# User's Manual

Version 2.0



**ICP DAS CO., LTD.**  
泓格科技股份有限公司

---

---

## Warranty

All products manufactured by ICP DAS are under warranty regarding defective materials for a period of one year, starting from the date of delivery to the original purchaser.

## Warning

ICP DAS CO., LTD. assumes no liability for damages consequent to the use of this product. ICP DAS CO., LTD. reserves the right to change this manual at any time without notice. The information furnished by ICP DAS CO., LTD. is believed to be accurate and reliable. However, no responsibility is assumed by ICP DAS CO., LTD. for its use, or for any infringements of patents or other rights of third parties resulting from its use.

## Copyright and Trademark Information

© Copyright 2017 by ICP DAS CO., LTD. All rights reserved worldwide.

## Trademark of Other Companies

The names used for identification only maybe registered trademarks of their respective companies.

## License

The user can use, modify and backup this software on a single machine. The user may not reproduce, transfer or distribute this software, or any copy, in whole or in part.

## Technical Service:

Please contact local agent or email problem-report to [service@icpdas.com](mailto:service@icpdas.com) .  
For more product information, please refer to [www.icpdas.com](http://www.icpdas.com) .

Technique: Cony Yu; Translation & Edition: Eva Li; R&D Dept., ICP DAS CO., LTD.  
Latest edited by: Eva Li; V. 2.0, 08/2020

---

# Contents

<b>Contents</b>	<b>3</b>
<b>Revision History</b>	<b>5</b>
<b>Read Me First!</b>	<b>6</b>
Important Notes .....	6
<b>1 Introduction</b>	<b>7</b>
1.1 Hardware Overview .....	8
1.2 Specifications.....	9
<b>2 Installation and Setup</b>	<b>12</b>
2.1 Install Camera and Fix it on the Bracket .....	12
2.2 Install microSD Card .....	15
2.3 Connecting Camera to Network .....	16
2.4 Configuring Camera via CAM FINDER .....	17
2.4.1 Use CAM FINDER to Assign IP Address .....	19
2.4.2 Open the Web-based UI of the Camera .....	22
<b>3 Live View UI Settings</b>	<b>25</b>
3.1 Quick Access Buttons .....	27
3.2 Camera Live View UI Setting Tools .....	28
<b>4 Setup</b>	<b>36</b>
4.1 System Setup.....	37
4.1.1 Information Tab .....	38
4.1.2 Time Tab.....	39
4.1.3 Security Tab .....	41
4.1.4 Maintenance Tab.....	43
4.1.5 System Log Tab .....	45
4.2 Network Setup .....	46
4.2.1 General Tab.....	47
4.2.2 DDNS Tab .....	49
4.2.3 Multicast Tab .....	50
4.2.4 IP Filter Tab .....	51
4.2.5 WISE Tab .....	52
4.3 Video & Audio Setup.....	53
4.3.1 Video Tab.....	54
4.3.2 Stream Tab.....	62
4.3.3 Audio Tab .....	65

---

4.3.4	Privacy Mask Tab .....	66
4.3.5	Fisheye Settings Tab .....	68
4.4	Event Setup .....	69
4.4.1	Motion Tab .....	70
4.4.2	Video Tab.....	72
4.4.3	Snapshot Tab .....	77
4.4.4	GPIO Tab.....	82
4.5	Local Storage Setup .....	83
4.5.1	Local Storage Tab .....	84
4.5.2	Playback Tab.....	85
4.6	Remote Storage Setup.....	86
4.6.1	Remote Storage Tab.....	86
<b>5</b>	<b>Appendix</b>	<b>87</b>
5.1	Firmware Upgrade and Trouble Shooting.....	87
5.2	How to let camera to do Hardware Reset .....	97

# Revision History

Revision History Table

Doc. Version	Revision Description	Date
2.0	<p>Modify List of Version 2.0:</p> <ol style="list-style-type: none"><li>1. The new website of ICP DAS is online in May 2020, so change the links in this manual to the new webpages.</li><li>2. ICP DAS Homepage: <a href="http://www.icpdas.com/">http://www.icpdas.com/</a></li><li>3. iCAM Products Website: <a href="http://www.icpdas.com/en/product/guide+IIoT+IO_Sensor+IP_Camera">http://www.icpdas.com/en/product/guide+IIoT+IO_Sensor+IP_Camera</a></li></ol>	20200818
1.0	<p>Initial Official Release</p> <ol style="list-style-type: none"><li>1. For Chapter 1, add features, hardware picture and specifications.</li><li>2. Add Section 2.2 about how to install microSD card into the camera.</li><li>3. Add Section 4.3.5 WISE Tab for communicating the camera with the WISE controller to perform a WISE Surveillance Solution.</li><li>4. For Chapter 3, modify the "Live View" button related descriptions.</li><li>5. For Chapter 1 to 5, modify its description for more detail and clear.</li></ol>	2017/08/10

---

# Read Me First!

---

## Important Notes

This User Manual is intended for administrators and users of the iCAM-771 IR Fisheye Type Network Dome Camera, including instructions for using and managing the camera on your network. The use of surveillance devices may be prohibited by law in your country or area. It is therefore the user's responsibility to ensure that the operation of such devices is legal before installing this unit for its intended use.

Before the Network Dome Camera is installed, carefully read and follow all the safety and operating instructions to avoid damage due to faulty assembly and installation. This also ensures that the device is used properly as intended.

## Heed All Warnings

- **Do not drop or hit the device.**  
Sensitive electronics inside the camera are vulnerable to excessive impact.
- **Do not install the device under high temperature (less than 45°C) environment.**  
Excessive heat could damage the equipment.
- **Do not cover device with any object or install it in a poorly ventilated vicinity.**  
Overheating could damage the camera.
- **Do not expose the device to rain or moisture. Do not touch the power connection with wet hand.**  
Risk of short circuit, electric shock, or fire
- **Do not damage the power cord or leave it under pressure.**  
Risk of fire or circuit electric shock
- **To reduce the risk of electric shock or damage, do not remove the front or back cover.**  
There is no user-serviceable parts inside. Misusage, improper, or negligent handling could damage the device. Refer to qualified service personnel from our distributor/dealer for any device related trouble shooting need.
- **Do not continue to operate the device if it appears to malfunction.**  
Contact qualified service personnel from our distributor/dealer for help.
- **Installation of the product should be made by qualified service personnel or system installers from our distributor/dealer.**

# 1 Introduction

**iCAM-771** is Intelligent IR Fisheye Network Dome Camera featured with 5 Mega Pixel resolution; also this model has superior H.264-AVC performance and rich functions.

**iCAM-771** includes fisheye lens for 360° panoramic wide angle view without blind spot and built-in IR to effectively see 10 meters distance. With WDR enhancement, you could view in extremely bright or dark environments. It is very suitable to install in public office, entrance, transportation and shop without the need to install multiple cameras.

Base on this hardware's video processing ability, **iCAM-771** provides user various video layout including Original View, Double Broad View, Triple View and Quad View. The ePTZ function, including preset point without moving parts, can replace part of traditional PTZ camera and thus save lost of traditional mechanical Pan/Tilt maintain cost.

Further functions include Auto Pan, Auto Patrol, two-way audio, DI/DO alarm application and microSD / microSDHC / microSDXC 64 GB card support for local storage application.



## Features:

- 5-Megapixel CMOS Sensor
- Dewarping the Image via Fisheye Correction Processor
- Removable IR-cut Filter for Day & Night Function
- Built-in IR illuminators, Effective Distance up to 10 meters
- Real-time H.264, MPEG-4, and MJPEG Compression
- ROI (Region of Interest) Provide for 5 Independent Streams
- WDR Enhancement for Visibility in Extremely Bright or Dark Environments
- 2-way Audio Communication, External Microphone Input & Audio Output
- Built-in microSD Card Slot, support microSDHC / microSDXC 64 GB or above
- Weather-proof IP66-rated & Vandal-proof IK10-rated Housing
- Built-in 802.3af Compliant PoE
- ONVIF Compliant for Interoperability
- EN50155 Compliance

## 1.1 Hardware Overview

### iCAM-771



### Dimensions

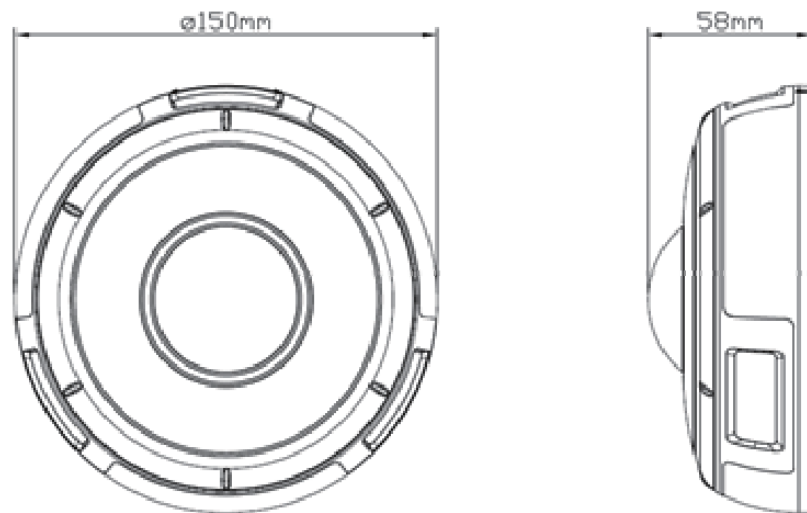

### Cable Connections:



※ Please note that RJ45 network cable has to plug to the PoE Port cable that with LED indicator, connect to incorrect one may damage camera hardware.



## 1.2 Specifications

Model	iCAM-771
System Information	
CPU	Multimedia SoC (System-on-Chip)
NOR Flash	16 MB
RAM	512 MB
Camera Features	
Image Sensor	1/2.5" Progressive CMOS sensor
Maximum Resolution	2592x1944, 5 MP
Lens Type	Fisheye Fix Lens f=1.57mm, F2.2 (Optional Lens : f=1.05mm, F2.8)
Field of View	180° (Horizontal/Vertical/Diagonal)
WDR Technology	WDR Enhanced
Day/Night	Removable IR-cut filter for day & night function
Minimum Illumination	0.5 Lux @F2.2 (Color); 0 Lux @F2.2 (B/W), IR ON
Pan/Tilt/Zoom	ePTZ: 10x digital zoom
IR illuminators	Built-in IR illuminators (LED x 6pcs ; optional LED x 8pcs), effective up to 10 meters
On-board Storage	Built-in microSD card slot, support microSDHC / microSDXC 64 GB or above
Video	
Compression	H.264 / MJPEG / MPEG-4
Display Mode	360° Source View, 360° Broad View, 180° Double Broad View, Triple View, Quad View, 3 PTZ with Source View
Maximum Frame Rate	10 fps at 2592x1944 15 fps at 1920x1920 (Support HD Dewarp) 15 fps at 1920x1080 30 fps at 1600x1200 (HI-FPS Mode) 30 fps at 640x480
Maximum Streams	5 simultaneous streams at ROI Mode 3 simultaneous streams at Normal Mode
S/N Ratio	Above 39 dB
Dynamic Range	67 dB
Video Streaming	Adjustable resolution, quality and bit rate ROI (Region of Interest) Provide for 5 Independent Streams

<b>Model</b>	<b>iCAM-771</b>
Image Settings	Adjustable image size, quality and bit rate Configurable brightness, saturation, exposure control; sharpness, contrast, white balance, auto shutter control; auto gain control, noise reduction, EV luminance control; flip & mirror, privacy masks, time stamp, text overlay
Audio	
Audio Capability	Audio input/output (full duplex)
Compression	G.711u
Network	
Users	Live viewing for up to 10 clients
Protocols	HTTP,HTTPS, TCP/ IP,IPv4, UDP, SMTP, FTP, DHCP, DDNS, NTP, DNS, ARP,RTSP, RTP, UPnP, ONVIF(Profile S), Multicast
Protection	Multiple user access levels with password protection, IP address filtering
Interface	10 Base-T/100 BaseTX Ethernet(RJ-45)
ONVIF	Ver.2.2
Intelligent Video	
Motion Detection	Ten-windows video motion detection
Alarm and Event	
Alarm Triggers	Motion detection, periodical trigger, digital input
Alarm Events	Event notification using digital output, HTTP, SMTP, FTP and NAS server File upload via HTTP, SMTP, FTP and NAS server
General	
Connectors	RJ-45 connector for Network/PoE connection RJ-45 connector for Multi-function Audio input Audio output Digital input x1 Digital output x1 Video output Default Setting
LED Indicator	System power and status indicator
Power Input	IEEE 802.3af PoE DC 12V
Power Consumption	Max. 10W (IR ON)
Dimensions	Ø:150 x 58mm

<b>Model</b>	<b>iCAM-771</b>
Casing	Vandal-proof IK10-rated metal housing Weather-proof IP66-rated housing
Net Weight	870g
Safety Certifications	CE, FCC Class B, LVD, EN50155
Operating Temperature	0°C ~ 50°C
Operating Humidity	10% ~ 80%
<b>System Requirements</b>	
Operating System	Microsoft Windows 10/8/Vista/XP
Web Browser	Mozilla Firefox 7 ~ 52, Internet Explorer 7 ~ 11
Other Players	VLC: 1.1.11 or above



*360° Panoramic View*



*180° Panoramic View*

# 2 Installation and Setup

## 2.1 Install Camera and Fix it on the Bracket

1. Extract the round mounting plate from the camera enclosure by pressing then turning it counterclockwise.

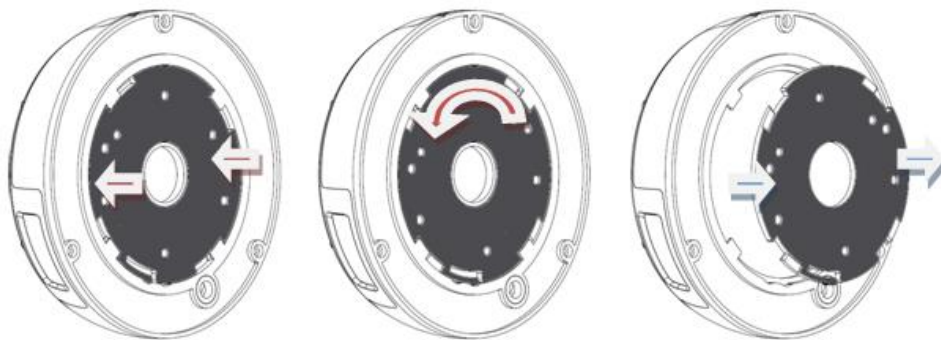

2. Attach the provided alignment sticker to the ceiling / wall where the camera is going to be installed.

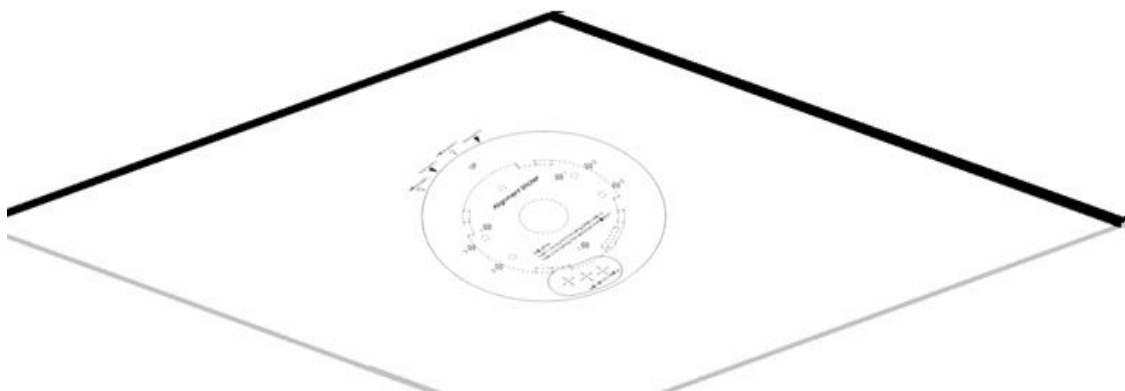

3. Drill the screw holes for either.
  - a. round mounting plate or
  - b. the Z-brackets

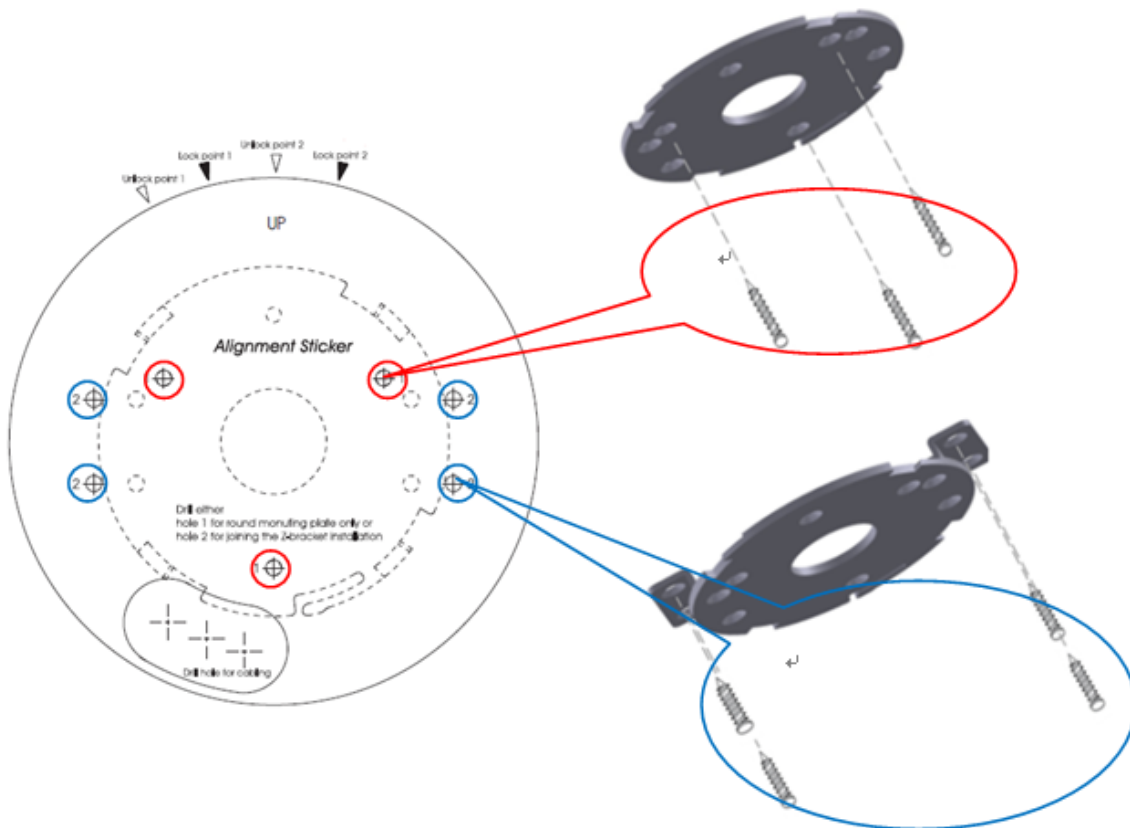

4. After screwing the mounting plate on the wall, drill a hole as indicate on the sticker. Gently get the cable to go through the hole before installing the camera.

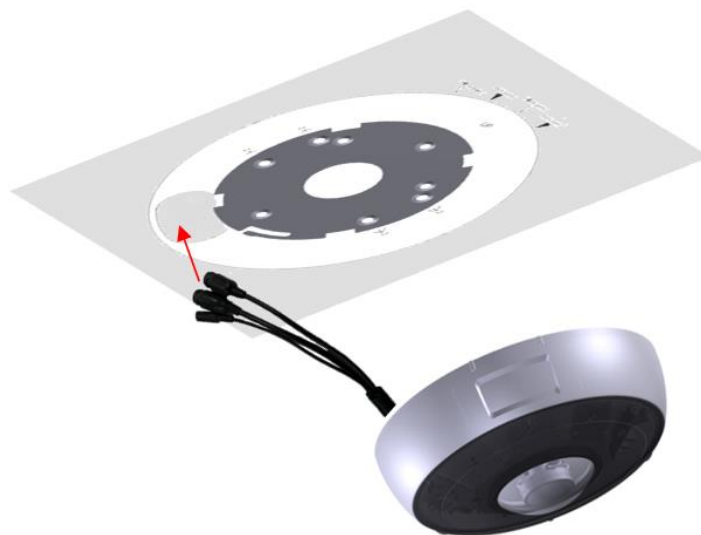

5. Attach the camera by matching the alignment marks to the unlock points (red arrows) and edge line on the sticker. Twist the camera clockwise, then 2 alignment marks should be shifted to the lock points. After that, the camera will be securely fastened.



6. Installation completed.



**5~6 meters high would have better visual effect;**  
Would prevent light halo caused by different directions reflected light.

## 2.2 Install microSD Card

The iCAM-771 built-in microSD card slot supports microSDHC / microSDXC 64 GB or above for local storage application.

The user can prepare a microSD card to install into the camera via the following steps.

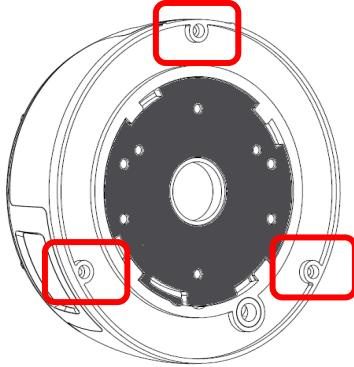
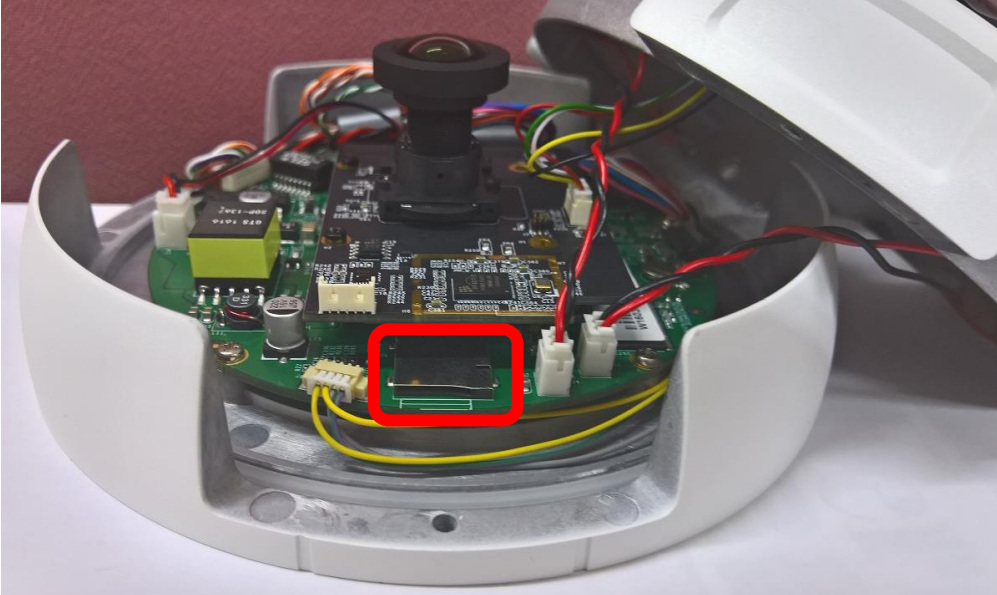
Step 1	Loose the 3 screws from the bottom of camera, and then remove the cover. 
Step 2	Find the microSD card slot as the following picture, and insert the microSD card into the slot. Finally, install the cover back to the camera. 

## 2.3 Connecting Camera to Network

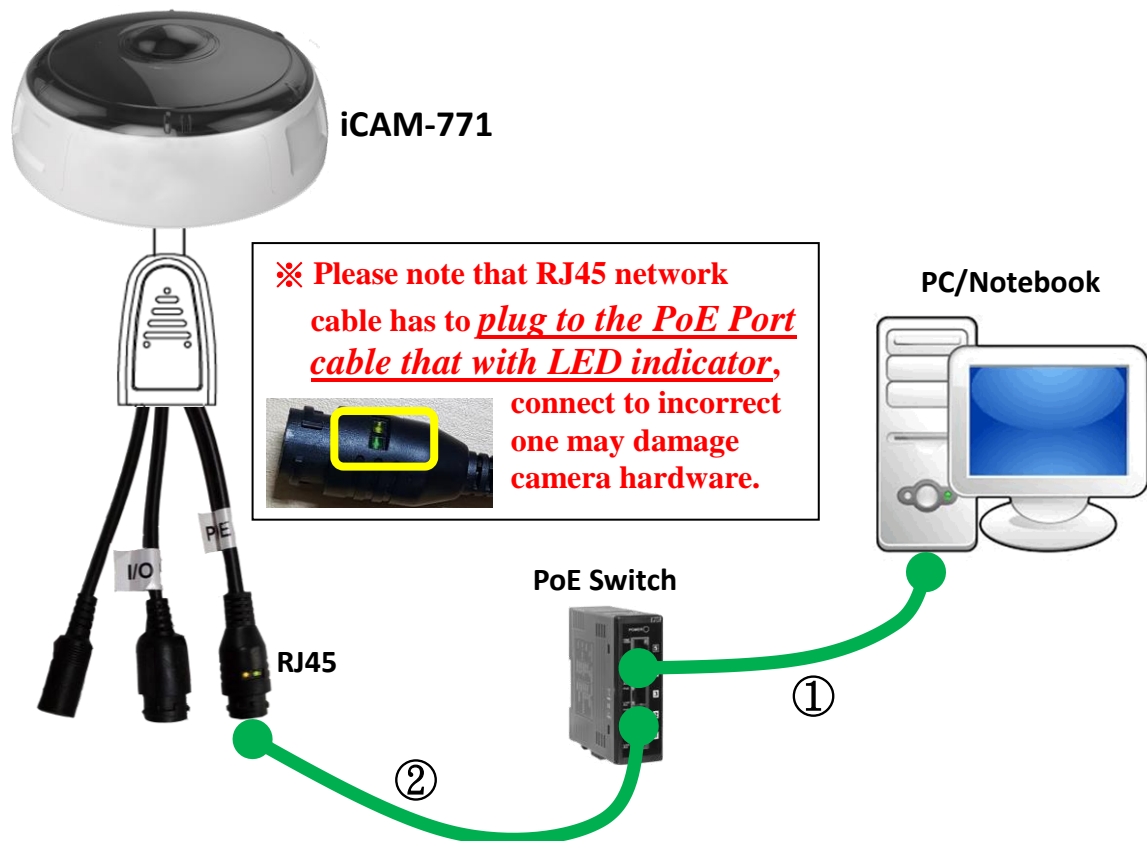

- 1) Be sure that your PC or laptop has connected to your local Ethernet network.
- 2) Be sure that IP Camera has connected to your local networking via the LAN port (RJ45) on the cable. For this PoE model, user can use PoE Switch as power supply.
- 3) Use CAM FINDER software utility in CD to set up the camera (see [2.4 Configuring Camera via CAM FINDER](#)), or directly set up the camera via the Microsoft IE browser using the following default IP information:

**IP: 192.168.255.2      (Default Username/Password: admin/admin)**  
**Submask: 255.255.0.0**  
**Gateway address: 192.168.0.1**  
**DNS Server address: 8.8.8.8**



---

## 2.4 Configuring Camera via CAM FINDER

The user can configure iCAM by default IP address or via the software utility.

The default IP Address configuring: see [2.3 Connecting Camera to Network](#)

The software utility **CAM FINDER** is in the attached Software Package CD.

The **CAM FINDER** is used to find and configure network cameras on the LAN. This utility is useful for conveniently configuring the network settings of the device, or for finding a device once the network settings have been modified.

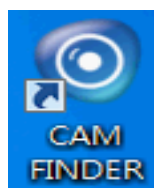

The **CAM FINDER** programs are located in the Software **iCAM CD** provided together with the device. Please insert the CD into the PC CD-ROM Drive, open the folder “**Software\_Utility**” and then “**CAM FINDER**”. Launch the **CAM FINDER** setup file “**setup.exe**” and complete the installation step by step.

**iCAM CD Path:** \Software\_Utility\Cam Finder\  setup.exe

The latest version of the **CAM FINDER** software program is available on the **iCAM** product website:

[http://www.icpdas.com/en/product/guide+IIoT+IO\\_Sensor+IP\\_Camera](http://www.icpdas.com/en/product/guide+IIoT+IO_Sensor+IP_Camera)

Or directly download from the following FTP path:

<http://www.icpdas.com/en/download/index.php?nation=US&kind1=&model=&kw=iCAM>

### NOTE

1. In order to ensure **CAM FINDER** utility has the best compatibility with Camera, kindly please ask for distributor/dealer’s help to get the latest version downloading.
2. In order to ensure Camera will be assigned IP Address properly, please confirm the following things.
  - Always consult your network administrator in order to avoid using a previously assigned IP address.
  - Check if the Camera is powered on and correctly connected to the network.
  - In order to connect to the Web-based user interface of the camera, the host PC must be in the same subnet. For more information about subnets, please consult your network administrator.

Once CAM FINDER has been successfully installed on the PC/notebook, double click the CAM FINDER icon on the Desktop of PC or choose “**Start > All Programs > CAM FINDER**” path to run the software.



The **CAM FINDER** window is showing as the following picture.

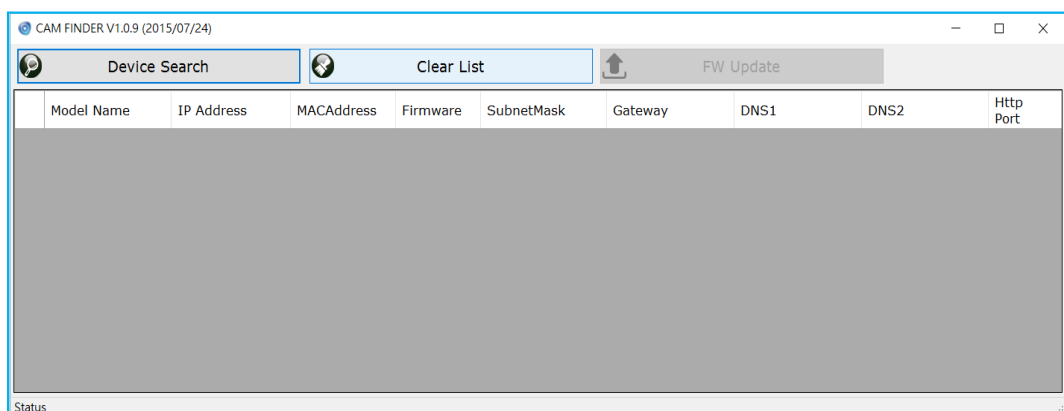

If want to change the **software language**, please click the right key of mouse on the gray area and select the [Language] to choose one language from the [Traditional Chinese], [English], [Spanish] and [Simplified Chinese].

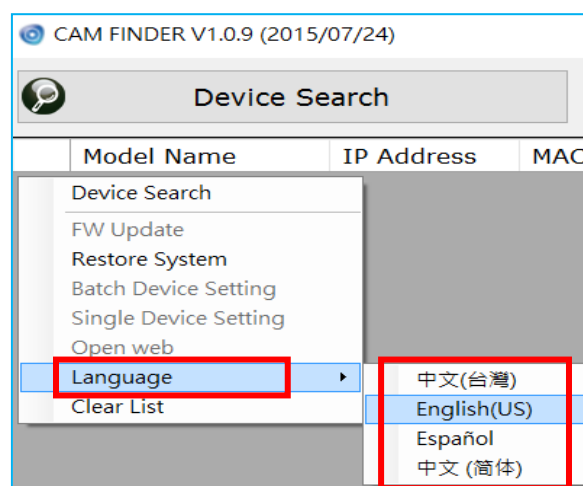

## 2.4.1 Use CAM FINDER to Assign IP Address

1. Click the [Device Search] to search the camera on the network.

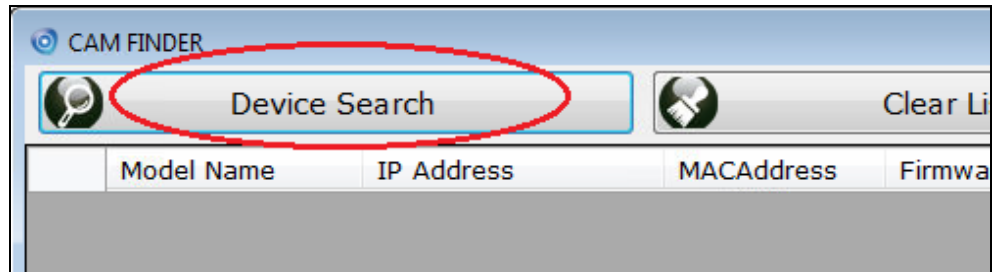

2. Under your selected item, double-click the left Mouse button or Right-click the Mouse button to open the Property Page of the [Single Device Setting].

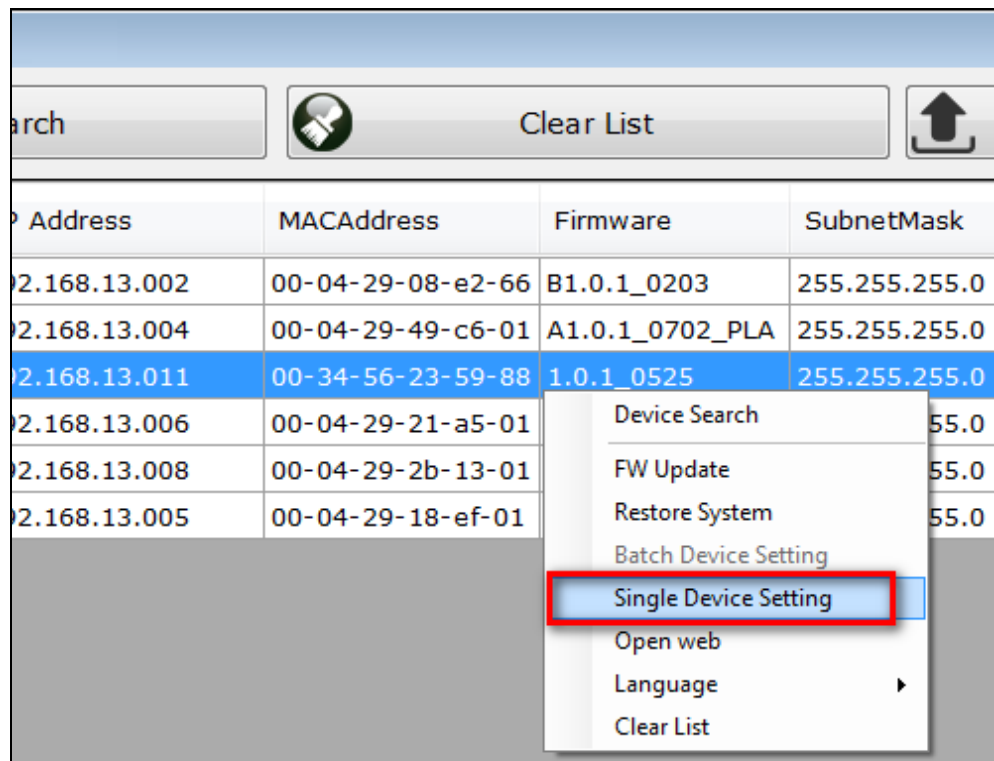

3. Check [**Static IP address**] item to select the network connection method of the camera.

The screenshot shows the 'Property' dialog box with the following settings:

Device Setting	Value
MACAddress	00-34-56-23-59-88
Firmware	1.0.1_0525

**Property**

<input checked="" type="checkbox"/> Static IP address	
IP Address	192 . 168 . 13 . 11
SubnetMask	255 . 255 . 255 . 0
Gateway	192 . 168 . 13 . 1
Http Port	80
DNS1	192 . 168 . 0 . 6
DNS2	192 . 168 . 0 . 5

**Certification**

Use Custom

Username: admin  
Password: \*\*\*\*\*

**DHCP**

Use DHCP Service

Buttons: Set, Cancel

4. After modifying the camera properties, click [**Set**] button to save and enable the configuration modifications.

The screenshot shows the 'Property' dialog box with the following settings:

Device Setting	Value
MACAddress	00-34-56-23-59-88
Firmware	1.0.1_0525

**Property**

<input checked="" type="checkbox"/> Static IP address	
IP Address	192 . 168 . 13 . 11
SubnetMask	255 . 255 . 255 . 0
Gateway	192 . 168 . 13 . 1
Http Port	80
DNS1	192 . 168 . 0 . 6
DNS2	192 . 168 . 0 . 5

**Certification**

Use Custom

Username: admin  
Password: \*\*\*\*\*

**DHCP**

Use DHCP Service

Buttons: Set, Cancel

5. This Utility can batch modify IP address automatically. Use “Ctrl” or “Shift” key on the keyboard to choose several Camera Devices. Then click the **[Batch Device Setting]** to configure them together.

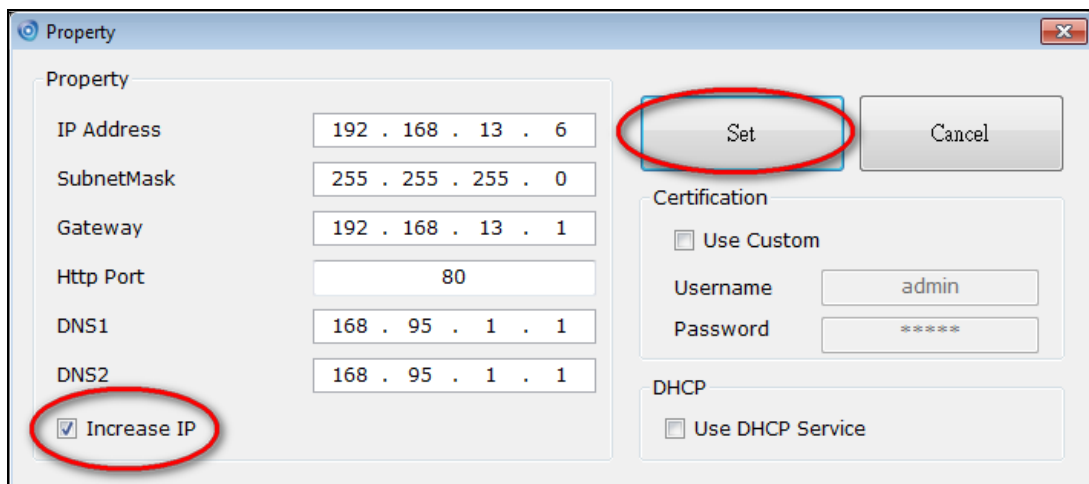
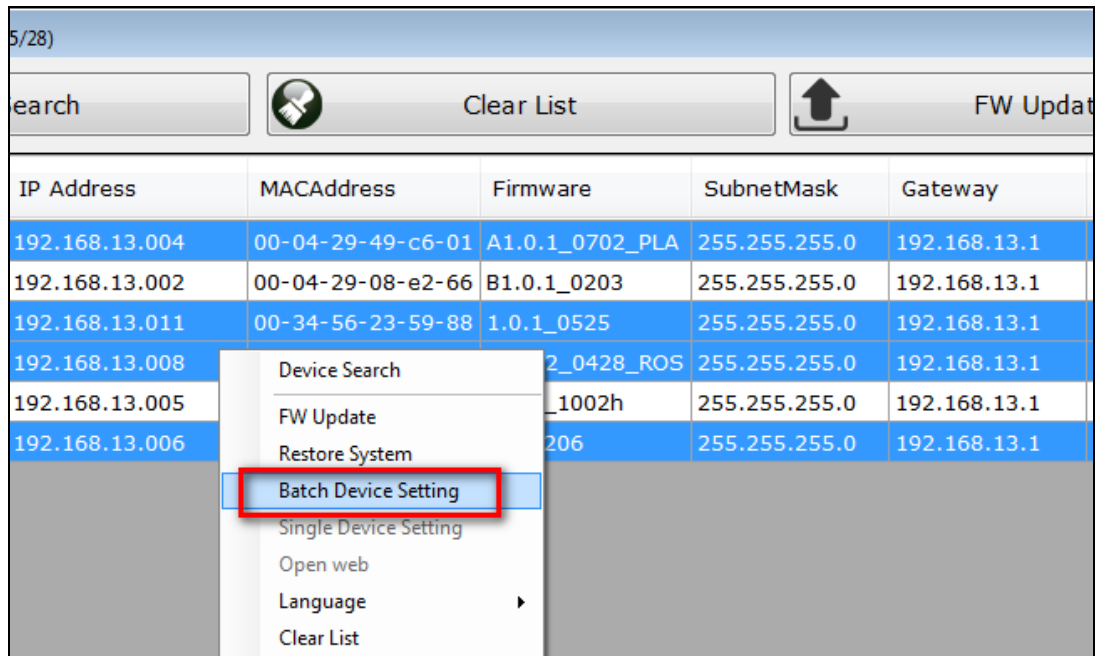

## 2.4.2 Open the Web-based UI of the Camera

- To access the Web-based UI of the selected unit, run the [Open Web] on the select item from the CAM Finder software window.

del Name	IP Address	MACAddress	Firmware	Subn
760D	192.168.13.004	00-04-29-49-c6-01	A1.0.1_0702_PLA	255.2
760D	192.168.13.002	00-04-29-08-e2-66	B1.0.1_0203	255.2
760D	192.168.13.011	00-34-56-23-59-88	1.0.1_0525	255.2
760D	192.168.13.008		2_0428_ROS	255.2
760D	192.168.13.005		2_1002h	255.2
760D	192.168.13.006		1206	255.2

- Manual input the username and password for the login authentication of camera webpage. For the first time login of setting or using, please use the default username admin, password admin.

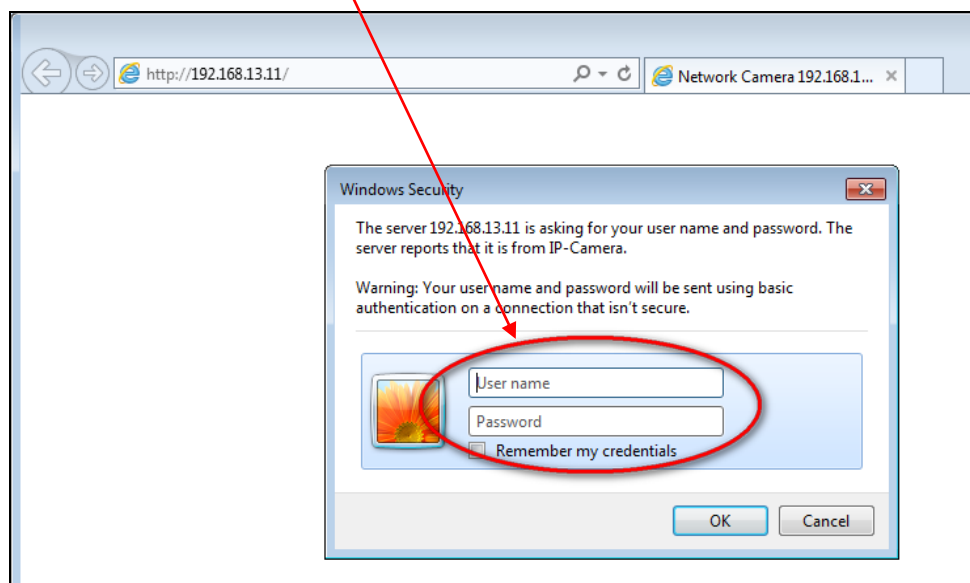

**NOTE:**  
**Use of Microsoft IE browser is recommended as it offers a better compatibility.**

3. For first time user, there will be a prompt to install the **NetcamViewer** and allow the ActiveX control. Comply with the ActiveX installation as they are needed to view the video stream and some other operations.

Besides, use of Microsoft IE browser is recommended as it offers a better compatibility.

Please click the **NetcamViewer** hyper-link to download and install it.

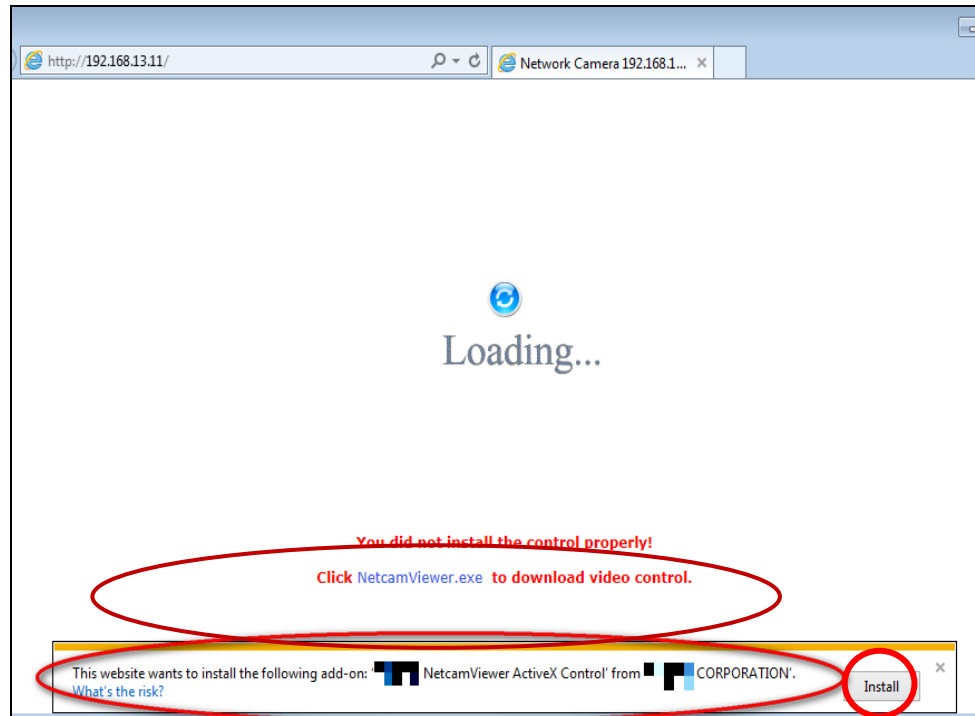

**NOTE:**

Please also note to close all browser applications before NetcamViewer web component installation.

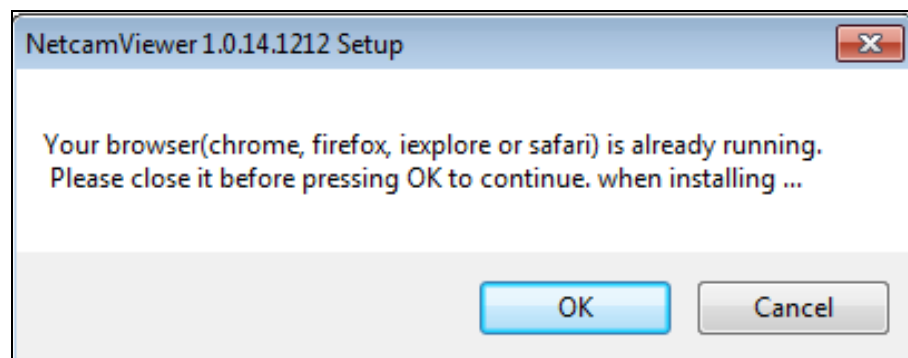

4. If the camera and browser components have been configured correctly, the default Web browser will open to the Live View page of the selected camera.

\* Username and password is required. (Default is admin / admin)

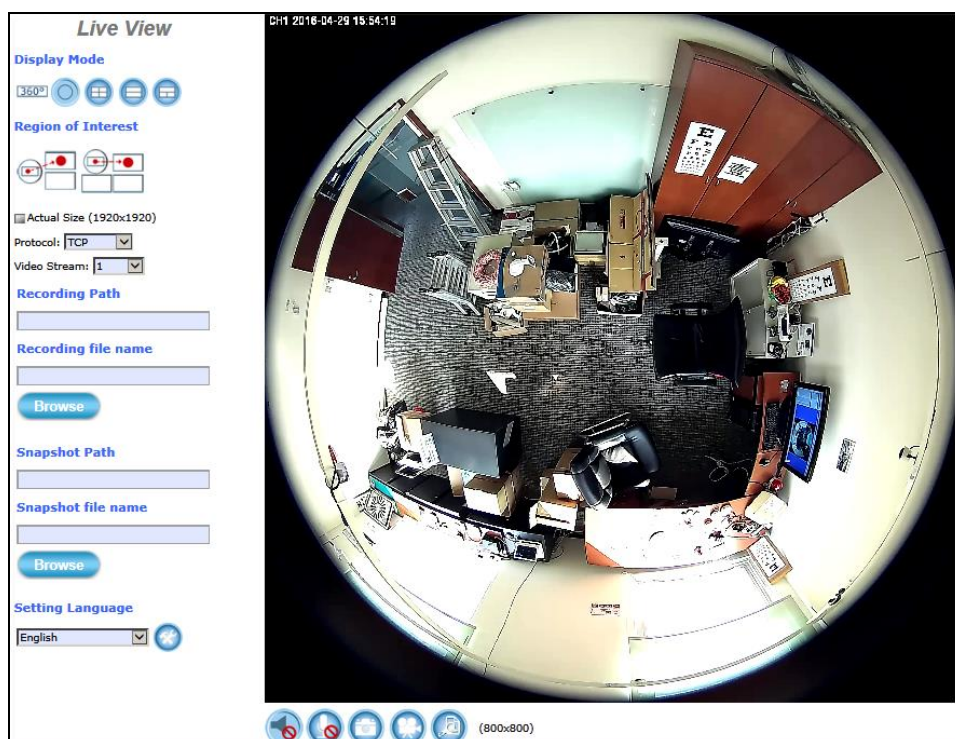

### **Verify and Complete the Installation from Your Browser**

If your IE Browser can't get the ActiveX download properly, you may have to temporarily lower your security settings to perform a one-time-only installation of the ActiveX component onto your workstation, as described below:

1. From the IE Browser menu, select **[Internet Options] -> [Security] -> [Custom Level]**
2. Set the security level to Low and click **[OK]**.
3. Don't forget to restore the security level after the ActiveX installation.



# 3 Live View UI Settings

In this chapter, you may change and reconfigure the Camera Live View UI (User Interface) to suit your need via PC/notebook.

First, open the Camera Web UI by the below steps, or refer to [Chapter 2.4.2 Open the Web-based UI of the Camera](#) for detail descriptions.

- 1) Execute your Web Browser and then manually enter the Camera Device's IP address gotten via **CAM FINDER** utility.



## NOTE

- *For the first time user, there will be a prompt to install the ActiveX control. Comply with the ActiveX installation as it is needed to view the video stream and some other operations.*
- *Use of Microsoft IE browser is recommended as it offers a better compatibility.*

- 2) Then the “Windows Security” dialog displays. Enter a username and password. You may enter “**admin**” for both. Click **OK** button when completed.



**(Note that same Browser with different version or different vendor Browser will behave different dialog window. Below picture is belonging to IE Browser's diagram.)**





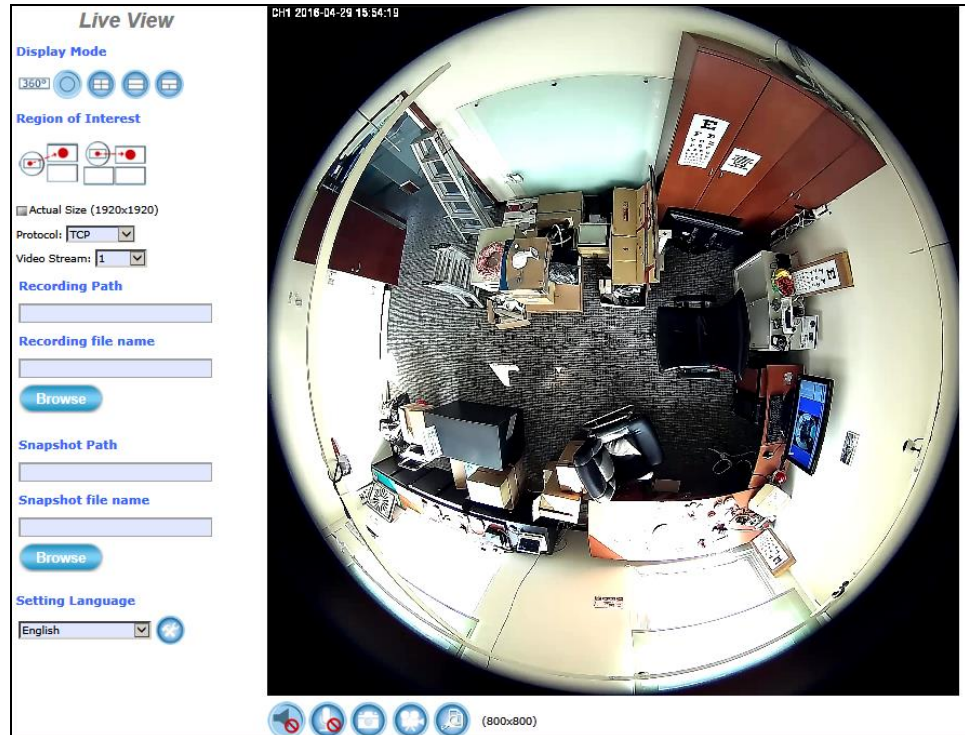



- 3) The “Live View Setting” window will then display offering all the necessary set up tools for changing the live view reconfigurations. The functions of each of these tools are explained in the following sections.



### 3.1 Quick Access Buttons

The following buttons provide the basic interactive functions between the Camera and the host computer as described below.

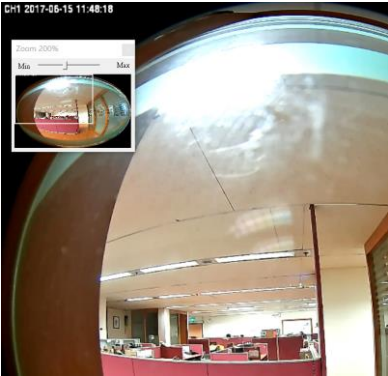

 	<p><b>Mute:</b> Click this button to turn <b>on/off</b> the Windows speaker of the host computer/NB. If turn it to the “Mute” status, the ActiveX will not let the IP CAM voice stream output to the Speaker of the PC/NB.</p>
 	<p><b>Chatting:</b> Click this button to <b>enable/disable</b> Chatting function to someone facing the network Camera from the computer. For ideal voice reception, the distance of the person on view, should be kept within 2 meters from the Camera.</p>
	<p><b>Snapshot:</b> Click this button to capture still images taken from the Camera and save them in the host computer/NB.</p>
	<p><b>Record:</b> Click this button to record live video clips from the Camera into your computer/NB.</p>
	<p><b>Digital Zoom:</b> Digital “zoom in” &amp; “zoom out” to the particular area of the live view; and the particular area also could be moved wherever you want to see. To display the whole live view into full screen mode, double click the mouse left button on the video; and press “ESC” key on the keyboard could exit full screen view.</p> 





## 3.2 Camera Live View UI Setting Tools

The **Live View** UI setting tools (the below figure) offer a variety of methods in changing the live view configurations of the Camera.

### Overview of Live View UI

**Live View**

**Display Mode**

360°     

**Region of Interest**

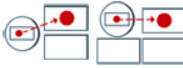

Actual Size (1920x1920)

Protocol:

Video Stream:

 **ePTZ function**

**Recording Path**

**Recording file name**

**Snapshot Path**

**Snapshot file name**

**Setting Language**



**Display Mode:**

With the part of fisheye lens, the Camera can offer 5 live view display modes: Panorama, Quad, Original, Double Broad and Triple View.

**Region of Interest:**

The camera can focus the interest region with two Operation Modes: Triple and Quad with Source View.

**ePTZ function:**

The ePTZ function will show up when the Double-Broad, Triple or Quad ePTZ display mode is selected. Click the “ePTZ function” to display the ePTZ setting tools.

**Recording Path / Recording file name:**

Specify a storage destination path for the video and define a base filename for the video you are going to record.

**Snapshot Path / Snapshot file name:**

Specify a storage destination path for the snapshot images and define a base filename for the snapshots you are going to capture.

**Setting Language:**











Select the default language of the user-interface.

 **Setup button:**

Click **Setup** button can change or update more Camera settings, including Video & Audio, System, Network, Event, Local Storage and Remote Storage.

■ **Display Mode:**

With its fisheye lens, the Camera can offer 5 live view display modes:

<p><b>Display Mode</b></p> 	<p>Panorama (360 degree Broad View)</p> 
	<p>Original (360 degree Full Panorama View)</p> 
	<p>Quad View</p> 
	<p>Double-Broad View (180 degree Ultra Wide Angle View x 2)</p> 
	<p>Triple View (180 degree Ultra Wide Angle View + Twin PTZ View)</p> 

■ Region of Interest (ROI):

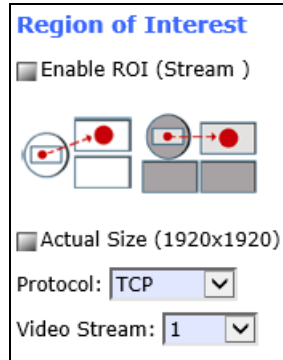

Region of Interest (ROI): Two Modes:

	Triple with Source View
	Quad with Source View

Select one ROI mode directly. After selection, the “Enable ROI (Stream)” function will appear.

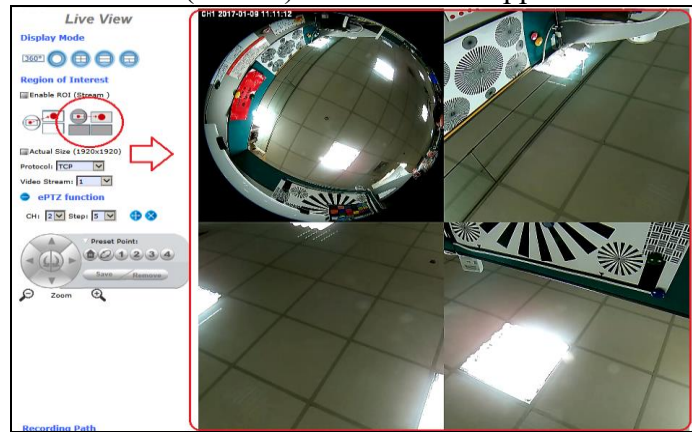

**Enable ROI (Stream):** Check the box to enable the ROI (Stream) function.





For the first time use, you may Left-click the mouse button under lower-left, upper-right or lower-right Live View Window. Then you could see a **x4 frame** displaying in the Source View Window.

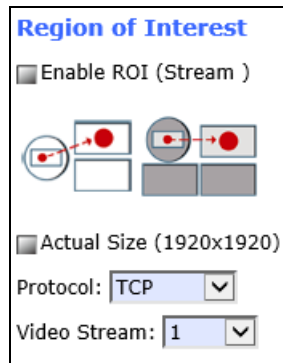

Scrolling the mouse wheel could change region’s magnifying power (x1 to x10); and dragging the frame with mouse could move the amplified region. In the meanwhile, you could also see region’s amplification effect displayed real time in the lower-left, upper-right or lower-right Live View Window.



While  **Enable ROI (Stream)** is checked, each window could be treated as an individual stream. Such as Quad with Source View will have five stream output maximum at the same time.

- **rtsp://camera ip address/live1.sdp** means whole display window  could be seen.
- **rtsp://camera ip address/live2.sdp** means upper-left Source View Window  could be seen.
- **rtsp://camera ip address/live3.sdp** means upper-right Display Window  could be seen.
- **rtsp://camera ip address/live4.sdp** means lower-left Display Window  could be seen.
- **rtsp://camera ip address/live5.sdp** means lower-right Source Display Window  could be seen.

**Actual Size:** Check to show the live view display resolution in actual size (1920 x 1920). The default is in “uncheck” status (800 x 800).

**Protocol:** Option for TCP, UDP or HTTP transmission protocol with H.264/MPEG4 streaming is available.

**Video Stream:** Two kinds of resolutions are available to let user choose; check higher or lower streaming would be suitable for user’s network environment.

■ ePTZ function:

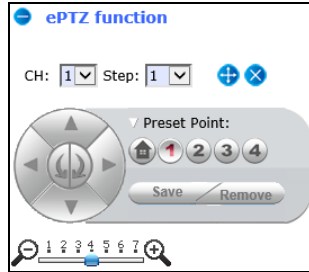



**+ ePTZ Function:** Click the **ePTZ function** button to display the ePTZ setting pane tools as the picture. The different Display Mode will show different ePTZ setting pane and the Original Display Mode does not support the ePTZ function (will not show ePTZ pane).

**- X :** Click either buttons to close the “ePTZ function” pane.

**+ :** Click and drag/drop this button to move ePTZ pane to a convenient location in the window.

**CH:** Select the ePTZ channel or display window (1, 2, 3 or 4) to implement ePTZ setting.

**Step:** Adjust and set the speed of live view panning motion.

**Directional/Rotate/Home Buttons:** Use to manually pan or rotate  the scene to select and zoom a specific area (1 of 4 maximum) to be monitored. To reset the scene back to its original status, click the Home  button.

You can also directly click the mouse button on the video to drag for pan and tilt, roll the mouse wheel for zoom a selected area.

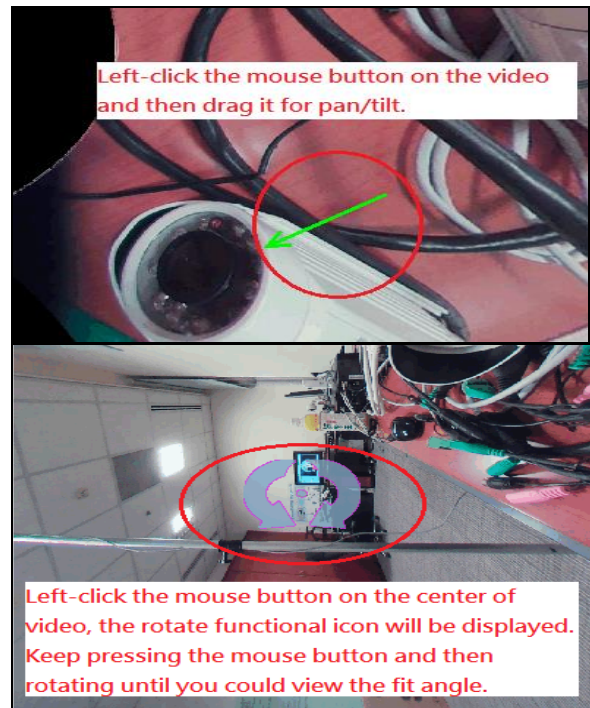



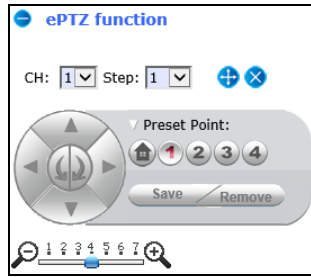

**Preset Point:**

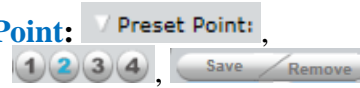

After panning and zooming, assign the selected area a Preset Point (1 to 4) and click **Save** button to store the setting. The pre-defined point of view areas will be monitored in sequence. To cancel the selection, click **Remove** button.



**Auto Patrol:**



While Preset Points are set, you could **check**  **Auto Patrol** function to execute. Then the camera view would automatically start to go to the preset locations in sequence (1->2->3->4) with the configured **Time Lapse** value. Uncheck it, Auto Patrol function would stop.

※ **Note that Auto Patrol function are dependent with camera hardware also.**

*Means if camera hardware on your hand isn't upgrade or supported these two functions may not be visible to let you choose.*



**Zoom Button:**

Click  button to zoom-in and  button to zoom-out the selected scene. Zoom setting is saved with the selected pre-defined point of view area.

## ■ Recording / Snapshot / Setting Language:

### Recording :

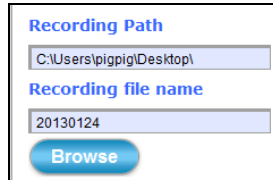

Recording Path  
C:\Users\pigpig\Desktop

Recording file name  
20130124

Browse

**Browse:** Click **Browse** button to define Recording Path and Recording Filename for the video you are preparing to record.

**Recording Path:** Specify a storage destination path for the video you are going to record.

**Recording file name:** Define a base filename for the video recordings you are going to take. EX: set as “office123”. It will auto-expand date & time for each saved video filename as “office123\_20170510\_102808.avi”.



: To start recording, click the **Recording** button in the Quick Access Button area.

### Snapshot :

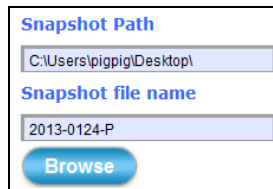

Snapshot Path  
C:\Users\pigpig\Desktop

Snapshot file name  
2013-0124-P

Browse

**Browse:** Click **Browse** button to define Snapshot Path and Snapshot Filename for the snapshots you are preparing to capture.

**Snapshot Path:** Specify a storage destination path for the snapshot images you are preparing to capture.

**Snapshot file name:** Define base filename for the snapshots you going to capture. EX: set as “night456”. It will auto-expand date & time for each saved snapshot file as “night456\_20170510\_102808.jpg”.



: To start capturing snapshots, click the **Snapshot** button in the Quick Access Button area.

### Language :

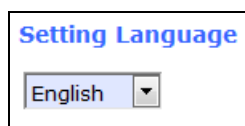

Setting Language

English

**Setting Language:** Select the default language of the user-interface.

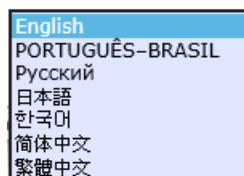

English  
PORTUGUÊS-BRASIL  
Русский  
日本語  
한국어  
简体中文  
繁體中文

## ■ Setup:



**Setup:** Click **Setup** button can change or update more Camera settings, including Video & Audio, System, Network, Event, Local Storage and Remote Storage.

As you get familiar with features and functions of your Camera, you may want to change or update a number of its settings to further upgrade its performance. This can be accomplished by clicking the **Setup** button (indicated in the above figure). The **Setup** dialog (see following figure) will then display to provide the range of setup categories you will be able to change.

Setup	
Live View	
<b>System</b>	
Network	
Video & Audio	
Event	
Local Storage	
Remote Storage	

Information	Time	Security	Maintenance	System Log
<b>System Information</b>				
Model Name:	iCAM-771			
System Time:	2017/05/18 11:35:45			
Firmware Version:	A1.0.3_0412_ICP			
MAC Address:	00:04:29:6b:dd:01			
ActiveX control version:	0.0.8.2			
<b>Wired network</b>				
Status:	Connected			
Mode:	DHCP			
IP Address:	192.168.1.46			
Subnet Mask:	255.255.0.0			
Gateway:	192.168.1.1			
Primary DNS:	211.78.130.2			
Secondary DNS:	208.91.112.52			
<b>DDNS Server</b>				
Status:	No connection			

# 4 Setup

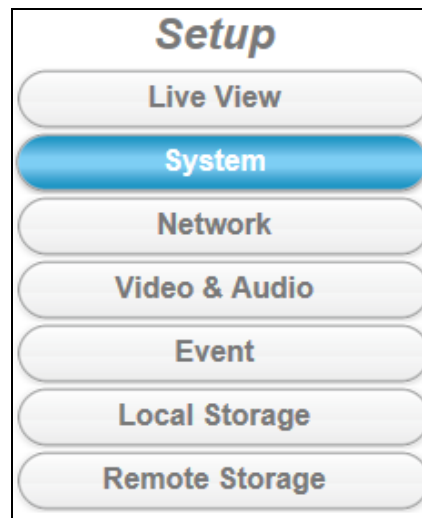
**NOTE**

*For “Live View” setup execution, please refer to the previous chapter “Live View UI Settings”*

## 4.1 System Setup



Clicking the **System** button will display the following tabbed panes relative to system configurations.

The screenshot shows a web interface for system setup. On the left is a sidebar with a "Setup" header and several buttons: "Live View", "System" (highlighted in blue), "Network", "Video & Audio", "Event", "Local Storage", and "Remote Storage". The main area has a tabbed interface with "Information", "Time", "Security", "Maintenance", and "System Log" tabs. The "Information" tab is active, displaying "System Information" and "Wired network" sections. The "System Information" section lists: Model Name: iCAM-771, System Time: 2017/05/18 11:35:45, Firmware Version: A1.0.3\_0412\_ICP, MAC Address: 00:04:29:6b:dd:01, and ActiveX control version: 0.0.8.2. The "Wired network" section lists: Status: Connected, Mode: DHCP, IP Address: 192.168.1.46, Subnet Mask: 255.255.0.0, Gateway: 192.168.1.1, Primary DNS: 211.78.130.2, and Secondary DNS: 208.91.112.52. Below this is a "DDNS Server" section with Status: No connection.

System Information	
Model Name:	iCAM-771
System Time:	2017/05/18 11:35:45
Firmware Version:	A1.0.3_0412_ICP
MAC Address:	00:04:29:6b:dd:01
ActiveX control version:	0.0.8.2

Wired network	
Status:	Connected
Mode:	DHCP
IP Address:	192.168.1.46
Subnet Mask:	255.255.0.0
Gateway:	192.168.1.1
Primary DNS:	211.78.130.2
Secondary DNS:	208.91.112.52

DDNS Server	
Status:	No connection

## 4.1.1 Information Tab

Information	Time	Security	Maintenance	System Log
<b>System Information</b>				
Model Name:	iCAM-771			
System Time:	2017/05/18 11:35:45			
Firmware Version:	A1.0.3_0412_ICP			
MAC Address:	00:04:29:6b:dd:01			
ActiveX control version:	0.0.8.2			
<b>Wired network</b>				
Status:	Connected			
Mode:	DHCP			
IP Address:	192.168.1.46			
Subnet Mask:	255.255.0.0			
Gateway:	192.168.1.1			
Primary DNS:	211.78.130.2			
Secondary DNS:	208.91.112.52			
<b>DDNS Server</b>				
Status:	No connection			

The **Information** tabbed pane provides the existing system status of the Camera which includes Model Name, System Time, Firmware Version, MAC Address, ActiveX Control Version, Wired Network, Wireless Network and DDNS Server Status.

## 4.1.2 Time Tab

The **Time** tabbed pane is where you set up the clock of your Camera to synchronize with your local time. Where:

**System Time:** The Network Camera current date and time is applied and displayed here based on the setup status of the System Time Settings as detailed below.

**Time Zone:** Select the applicable Time Zone of your city in reference to Greenwich Mean Time.

**Automatic:** Select this item if you want to automatically synchronize the Camera clock with your manually entered Network Time Protocol (NTP) Server.

**Keep current date and time setting:** Select this option in lieu of automatic synchronization if the Camera is not connected to NTP Server and uses its own embedded clock.

**System Time**

2017/06/16 11:18:54

**System Time settings**

Time Zone:

GMT+08:00 Beijing, Chongqing, Hong Kong, Kuala Lumpur, Singapore, Taipei, Krasnoyarsk

Automatic

NTP server: pool.ntp.org

Keep current date and time

Set Manually

Synchronize with computer time

Assign value

Date: 2017/06/16 (yyyy/mm/dd) Time: 11 : 18 : 14 (hh:mm:ss)

Enable Daylight Saving

Offset: +1 hrs

	Month	Week	Day of week	Hour	Minute
Start time	8	1	sunday	0	0
End time	10	1	sunday	0	0

Save

Ⓞ **Set Manually:**

Ⓞ **Synchronize with the computer Time:** Select this option to manually synchronize the Network Camera clock (date and time) with that of the local host computer.

Ⓞ **Assign value:** Select this option to enter the date and time manually.

**Enable Daylight Saving:** Select this option only when applicable at your location. Two setup settings; the **Start time** and **End time** are needed to implement the feature.

Save

After setups are completed, click **Save** button to apply the settings.



### 4.1.3 Security Tab

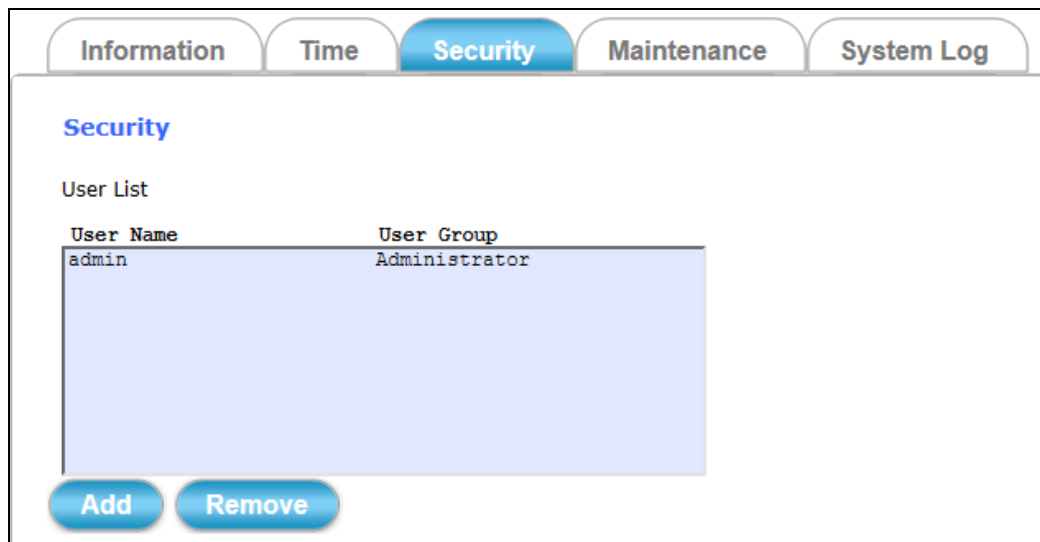

The **Security** tabbed pane allows you to add new Camera User Name and change Password and the surveillance status or User Group.

Where:



**User List:** This is a permanent default setting and cannot be removed nor changed. Hence, new User Name/Group settings are only added below the default setting.

**Add/Remove:** Click **Add** button can expand the security setup items to access and change the security setting status.

Click **Remove** button can remove the added security setting.

Click the **Add** button to access the security setup dialog (shown below).

**User Setup**

User Name:

Password:   Show Password

Confirm Password:

User Group:

Administrator

Operator

Viewer

Note:

1. A user name and password must contain at least one character.
2. Max 14 characters are allowed in user names.
3. The first character in user name must be A-Z or a-z.
4. Only A-Z, a-z and 0-9 are allowed in the user name and password.
5. Max eight characters are allowed in the password.
6. The maximum number of users is 20.
7. The 'admin' user is default user and cannot be deleted.

**User Name:** Enter the new user name to be added into the list (see Note 4 of dialog for proper entry).

**Password:** Enter the new password (see Note 4 of dialog for proper entry).

**Confirm password:** Enter the password again for authentication (encoded display).

**Show Password:** Displays the decoded password when check box is enabled.

**User Group:** Three group options are available, namely:

- Ⓒ **Administrator:** User is allowed to change Camera settings and perform all Camera functions.
- Ⓒ **Operator:** User is allowed to login “Live View” Webpage and perform all functions within this page. Except changing Video and Audio settings of Camera live stream, other adjustments of Camera parameter are prohibited.
- Ⓒ **Viewer:** User is only allowed to login “Live View” Webpage and perform all functions within this page. Changing Camera settings is prohibited.

After setups are completed, click **Save** button to apply the settings.

## 4.1.4 Maintenance Tab

Information
Time
Security
Maintenance
System Log

Model Name: ICAM-771  
Firmware Version: A1.0.2\_0616

**Remote Upgrade Firmware**

Server URL:

Auto Upgrade

New Version: No

Save
Refresh

**Local Upgrade Firmware**

Select firmware file:  Browse...

Upgrade

Download and save the latest firmware in the PC. Click here to browse and select it.

**Upload Own Logo File**

Right click the mouse button on ' Logo Image' (nlogo.png 165x50) and then select Save As to save image in the PC.

Select image file to upload:  Browse...

Upload

**Backup**

Save all parameters and user-defined scripts to a backup file.

Backup

**Upload Setting**

Use a saved backup file to return the unit to a previous configuration.

Specify the backup file to use:  Browse...

Restore

**Reboot System**

Reboot

**Restore System**

Factory Default

The **Maintenance** tabbed pane allows you to upgrade the firmware with the latest version and to restore the Network Camera settings to factory default.



※ Please specify the correct firmware version mapped with your camera to upgrade, or there will be danger to damage camera system.

**Remote/Local Upgrade Firmware:** Recommend to use the local upgrade.

Download the latest firmware file from the website. Follow the steps:

- 1) Click the **Browse** button to access and select the **appropriate** firmware file from its folder.
- 2) Click the **Upgrade** button. The Network Camera will then start to upgrade the existing firmware.

Upgrade

When upgrade is completed, the Camera will reboot automatically.

※ In [Appendix](#) chapter, there will be more detailed steps to guide you how to update camera firmware step by step.

**Backup:** Clicking the **Backup** button allows you to save Camera's parameters and user settings into a **config\_backup.tar.gz** file.

**Upload Setting:** This function allows user to restore Camera's backup setting by executing the below steps:

- 1) Click the **Browse** button to access and select saved **config\_backup.tar.gz** file from the PC.
- 2) Click the **Restore** button to process Camera configuration restore.

Restore

Reboot

**Reboot System:** Clicking the **Reboot** button allows you to manually reboot the Network Camera.

Factory Default

**Restore System:** Clicking the **Factory Default** button will restore the Network Camera to its factory default settings status. Before Camera system proceed to restore step, there'll be a dialog window popped and then ask if you would like to keep "**Network setting**" parameters. Besides, all configured data in the "**System Time**", "**Security**" and "**Maintenance**" tab will be remained current.

## 4.1.5 System Log Tab

The screenshot shows the 'System Log' tab selected. The 'Remote Log Settings' section includes:

- Enable remote log
- Log server IP address:
- Server Port:  (0..65535)
- Status: disconnected

A 'Save' button is located at the bottom left of the settings area.

The **System Log** tabbed pane allows you to see Camera’s basic log on another browser page or Remote Log Server.

Where:

**Logs:** Click “**Logs**” and then there will be another browser page opening and then displaying Camera’s basic log lists.

**Remote Log Settings:** Check “Enable remote log” selection first; and then manual entering IP address & port setting of Remote Log Server.

**Status:** The connected or disconnected of **Status** tell you if the IP Address of Remote Log Server is existence or not.

Save

After setups are completed, click **Save** button to apply the settings.

Then **Status** would shows “connected” or “disconnected”.

## 4.2 Network Setup



Clicking the **Network** button will display the following tabbed panes on configuring Camera connection with the network.

**Setup**

- Live View
- System
- Network**
- Video & Audio
- Event
- Local Storage
- Remote Storage

**General** | DDNS | Multicast | IP Filter | WISE

### Network Settings

DHCP

Fixed IP Address

IP Address:

Subnet Mask:

Default Router:

Primary DNS:

Secondary DNS:

PPPoE

### Port Settings

HTTP Port:

RTSP Port:

RTSP Authentication

**Save**

## 4.2.1 General Tab

The screenshot shows the 'General' tab selected in a settings interface. At the top, there are five tabs: 'General' (selected), 'DDNS', 'Multicast', 'IP Filter', and 'WISE'. Below the tabs, the 'Network Settings' section is visible. It has two radio button options: 'DHCP' (unselected) and 'Fixed IP Address' (selected). Under 'Fixed IP Address', there are five input fields: 'IP Address' (192.168.74.30), 'Subnet Mask' (255.255.0.0), 'Default Router' (192.168.1.1), 'Primary DNS' (211.78.130.2), and 'Secondary DNS' (208.91.112.52). Below this is the 'PPPoE' option, which is unselected. The 'Port Settings' section follows, with 'HTTP Port' (80) and 'RTSP Port' (554) input fields. There is also an unchecked checkbox for 'RTSP Authentication'. At the bottom left of the settings area is a blue 'Save' button.

The **General** tabbed pane (shown above) allows you to redefine the network and port protocol settings of the Network Camera.

Where:

### Network Settings:

- Ⓒ **DHCP:** This option obtains the available dynamic IP address assigned by the DHCP server each time the Camera is connected to the network.
- Ⓒ **Fixed IP Address:** This option manually assigns a static IP address to the Network Camera.

© **PPPoE**: Select this option to set PPPoE account & password.

● PPPoE	
PPPoE User Name:	<input type="text"/>
PPPoE Password:	<input type="password"/>
Recipient E-mail Address:	<input type="text" value="rcpt@mail.com"/> (ex: rcpt@mail.com )
SMTP E-mail Server:	<input type="text" value="192.168.1.1"/> (ex: mail.examples.com or 192.168.1.1 )
SMTP Port:	<input type="text" value="25"/> (0..65535)
SMTP user name:	<input type="text" value="guest"/>
SMTP Password:	<input type="password" value="••••"/>
Sender E-mail Address:	<input type="text" value="from@mail.com"/> (ex: from@mail.com )
Use SSL-TLS:	<input type="text" value="None"/> ▼

While PPPoE protocol is selected, you may have to enter some more information such as the above picture.

While Camera IP is changed dynamically because of PPPoE Network Connection, its new IP Address will be sent to “Sender E-mail Address” through SMTP service. So you won’t worry about the difficulty in Camera’s Webpage access.



※ As for the settings of SMTP Service, kindly please contact with your E-mail service provider ◦ After you confirm all parameters are correct and working properly, you may enter them into the text area manually.

### Port Settings:

- © **HTTP Port**: Re-define the existing HTTP Port number in the text box.
- © **RTSP Port**: Re-define the existing RTSP Port number in the text box.



After setups are completed, click **Save** button to apply the settings.



## 4.2.2 DDNS Tab

The screenshot shows the 'DDNS' configuration tab. At the top, there are five tabs: 'General', 'DDNS' (selected), 'Multicast', 'IP Filter', and 'WISE'. Below the tabs, the 'Dynamic DNS Settings' section contains the following elements:

- DDNS Enable:** A checkbox that is currently unchecked.
- Provider:** A dropdown menu set to 'dyndns.com'. Below it is a blue link: [Link to http://www.dyndns.com](http://www.dyndns.com).
- Host name:** A text input field containing 'hostname'. Below it is an example '(ex: ddns.test.com)' and a blue link: [Link to http://www.dyndns.org](http://www.dyndns.org).
- User Name:** A text input field containing 'username'.
- Password:** A password input field with ten dots. Below it is a 'Show Password' checkbox, which is unchecked.
- Update Time:** A text input field containing '1000', with '( 600~86400 Seconds )' to its right.
- Status:** The text 'No connection'.
- Save:** A blue button with the text 'Save'.

The **DDNS** tabbed pane allows you to configure the Dynamic Domain Name System of your network device with a host name instead of the IP Address.

Where:

**DDNS Enable:** Enable the check box to support DDNS function.

**Host Name:** Enter the Host name which you registered and got through DNS Service Provider. The assigned host name is used to access the network device instead of IP Address.

**User Name/Password:** Account authentication for logging into the website of DNS Service Provider.

**Show Password:** Enabled check box to display password in decoded format.

**Update Time:** Define a time interval for the device to periodically update and check its access status with website of DNS Service Provider.

After setups are completed, click **Save** button to apply the settings.

## 4.2.3 Multicast Tab

**Multicast Settings (Based on the RTSP Server)**

Multicast Group Address:  (224.3.1.0 ~ 239.255.255.255)

Multicast Port:  (1 ~ 65535)

Multicast TTL:  (1 ~ 255)

**Stream**

Enable

Multicast Video Port: 5560

Multicast Audio Port: 5562

Multicast Metadata Port: 5564

The **Multicast** tabbed pane allows you to open Camera's UDP Multicast Streaming function.

By default, Camera's live stream belongs to RTSP Protocol. It means camera has to send an individual streaming for each client wish to see the videos. So the more the client number is, the larger the network bandwidth required and the bigger loading of the camera.

In other words, the camera can send just one streaming and each client can receive the streaming with Multicast Protocol.

Even with the client number increasing, the network bandwidth is still the same loading with one camera.



**Enable:** Check the "Enable" box to open UDP Multicast Streaming function of stream.



After checking the "Enable" box to open this function, click **Save** button to apply the settings.

## 4.2.4 IP Filter Tab

The **IP Filter** tabbed pane could let you configure device IP list which is denied access to this camera.

Where:



**Add** Click the **Add** button to show the IP address input field.

**Start IP address:** Fill in the first address of IP range which you would like to deny its access to camera.

**End IP address:** Fill in the last address of IP range which you would like to deny its access to camera.



※ please note that total device numbers listed in the Deny list would be limited to 20.



Filling the IP range, then click **Save** button to implement the settings.



If you would like to re-open the access right of those listed device, select it from the list and then click **Remove** button to apply the settings.

## 4.2.5 WISE Tab

The screenshot shows a web interface with five tabs: General, DDNS, Multicast, IP Filter, and WISE. The WISE tab is active. Below the tabs, there is a label 'IP Address:' followed by a text input field containing '192.168.255.1'. A blue 'Save' button is located below the input field.

The **WISE** tabbed pane allows you to communicate the iCAM camera with WISE controller to perform a WISE surveillance system.

ICP DAS WISE surveillance solution integrates logic control, I/O, camera and data log in one single WISE controller. WISE allows two-way interactions between the I/O and the camera; it enables to record a piece of video or to take images when there is an event triggered by either I/O condition or ROI (Region of Interest) by camera. In this way, the storage size can be reduced significantly and the connection between I/O event and Video/Image can be built for easy query. Refer to [http://www.icpdas.com/en/product/guide+IIoT+IO\\_Sensor+WISE\\_I\\_O\\_Module#564](http://www.icpdas.com/en/product/guide+IIoT+IO_Sensor+WISE_I_O_Module#564).

Where:

**IP Address:** Fill in the IP address of WISE-5231.  
When the IP address is set, the CGI command is automatically sent to the WISE-5231 when an event occurs in this camera.



After setups are completed, click **Save** button to apply the settings.

## 4.3 Video & Audio Setup



Clicking the **Video & Audio** button will display tabbed panes for defining Camera video, streaming, and audio functions.

**Setup**

- Live View
- System
- Network
- Video & Audio**
- Event
- Local Storage
- Remote Storage

**Video** | Stream | Audio | Privacy Mask | Fisheye Settings

**Video Settings**

Day / Night Mode:  ▾

Brightness:  50 (0~100)

Saturation:  125 (50~200)

Contrast:  50 (0~100)

Sharpness:  100 (0~200)

Exposure Level:  65 (0~255)

Shutter Speed: 1/  ~ 1/  second(s)

Gain Control (ISO):  Auto  ▾  Manual

Power Frequency:  50 Hz  60 Hz

EV Compensation:  100 (50~200)

Noise Reduction  ▾

Strength:  140 (1~168)

DPC  ▾

Wide Dynamic Range:  Enable  Disable

Strength:  100 (1~200)

Source View Video Orientation:  ▾

White Balance:  ▾

**Advanced Settings**

Smart IR:  On  Off

Color/Mono Mode:  Auto  Color  Mono

Day / Night Threshold:  10 (5~100)

ICR:  Auto  On  Off

IR LED:  Auto  On  Off

Schedule

### 4.3.1 Video Tab

Video
Stream
Audio
Privacy Mask
Fisheye Settings



**Video Settings**

Day / Night Mode: Day

Brightness: 50 (0~100)

Saturation: 125 (50~200)

Contrast: 50 (0~100)

Sharpness: 100 (0~200)

Exposure Level: 65 (0~255)

Shutter Speed: 1/ 32000 ~ 1/ 30 second(s)

Gain Control (ISO):  Auto 16x  Manual

Power Frequency:  50 Hz  60 Hz

EV Compensation: 100 (50~200)

Noise Reduction 2D

Strength: 140 (1~168)

DPC Low

Wide Dynamic Range:  Enable  Disable

Strength: 1 (1~200)

Source View Video Orientation: Normal

White Balance: Auto

**Advanced Settings**

Smart IR:  On  Off

Color/Mono Mode:  Auto  Color  Mono

Day / Night Threshold: 10 (5~100)

ICR:  Auto  On  Off

IR LED:  Auto  On  Off

Schedule

The **Video** tabbed pane lets you to perform live adjustments and improvement of the Camera captured video effect relative to the target environment. Where:

### Video Settings:

**Day/Night Mode:** There are “Day” and “Night” 2 lens modes.

**Brightness:** The luminance of the captured image apart from its hue or saturation. Try to assign the fit value according to the environment

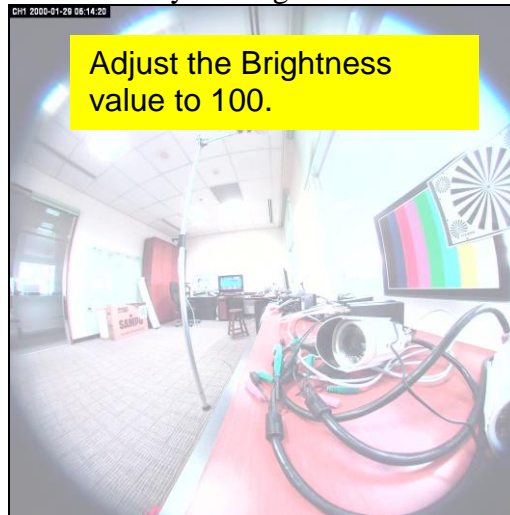

**Saturation:** The degree of intensity and purity of a specific color. Try to assign the fit value according to the environment.

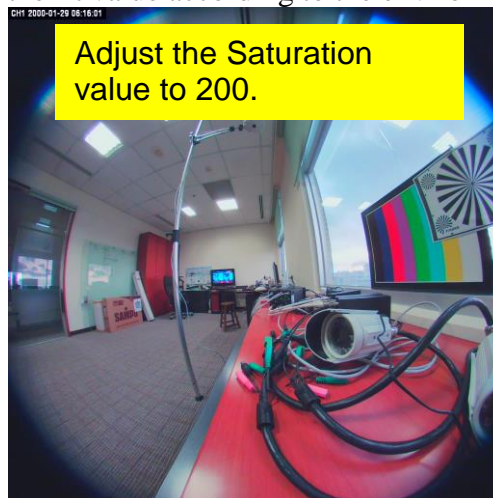

**Contrast:** The brightness ratio of the lightest to the darkest part of the video image. Try to assign the fit value according to the environment.



**Sharpness:** Sharpness can be defined as edge contrast. So when we increase sharpness, we increase the contrast only along/near edges. Try to assign the fit value according to the environment.

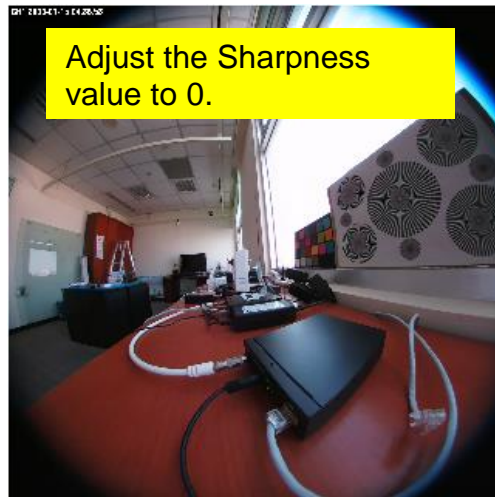



**Exposure Level:** It is used to control Exposure Target; and its behavior determined by Aperture and Shutter Speed.

So, if you leave the **Shutter** open longer, you're getting more light to the sensor, and the picture gets brighter; if Exposure is shortened (provide less light to the sensor), the picture gets darker.

※ **More exposure means you need slow Shutter Speed to bring more light; less exposure needs faster Shutter Speed to let less light in.**

**Shutter Speed:** It is the amount of time the shutter allows light to pass through the lens to the sensor.

In general, faster shutter speeds work well with a lot of light; if at night or want to see object moving in a dark area, slower shutter speed can freeze the motion.

**Gain Control (ISO):** Here provides more control in low light conditions. there are **Auto** and **Manual** selections to let user choose.

You could select **Auto** to let Sensor adjust; or **Manually** set its limited value.



※ Note that higher Gain value would result in brighter image; but also deliver more noise. Try to create a balance between brightness and resulting image noise.



**EV Compensation:** Exposure Compensation is a feature of a camera that allows you to adjust the exposure value manually. You may increase or decrease the amount of brightness or darkness of your picture through sliding the bar. Try to assign the fit value according to the environment.

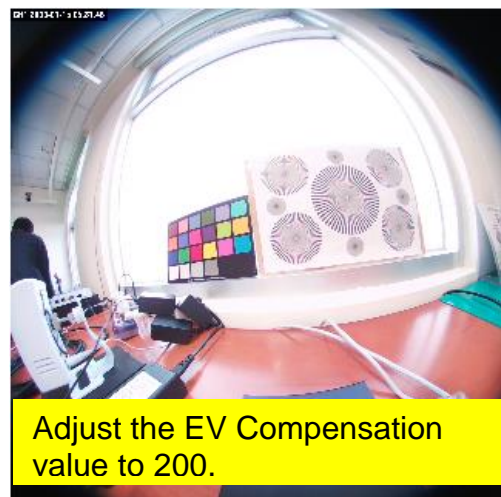
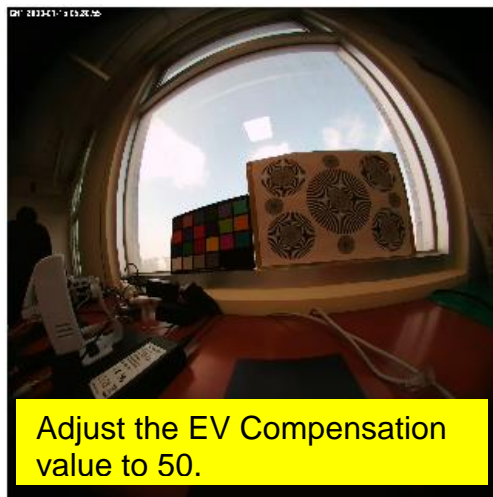

**Noise Reduction “2D/3D”:** They are kinds of technology to provide clearer video with less noise under poor lighting conditions, making it easier to identify people or objects. Try to set them according to the stream quality.

**DPC (Dead Pixel Correction):** This function could revise error pixels of the sensor real time and improves image quality. Here are three kinds strength (Low Mid and High) to choose; try to set them according to the pixel defective degree.



※ **Note:** Both Noise Reduction and DPC are technologies to remove noise; may result in blurriness and a loss of detail. Try to find a level that makes the image look clean without losing too much detail.

**Wide Dynamic Range:** Enable this function could let camera provide clear images even under backlighting.

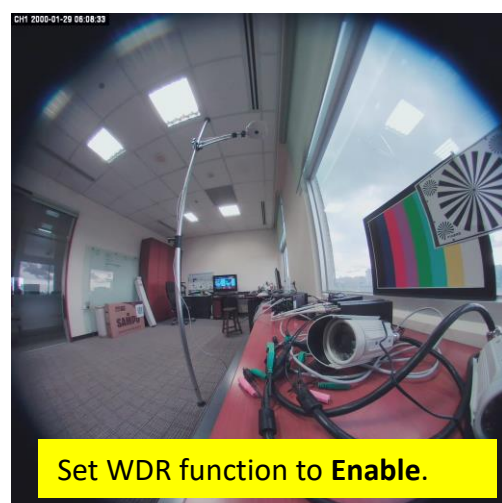

Also provide strength to let user set according to the environment.



**Source View Video Orientation:** In order to fulfill different camera install location, four kinds video orientation are provided.

※ Please also note video would rotate source view orientation first and then change to different display mode if user set in camera configuration.



Such as,

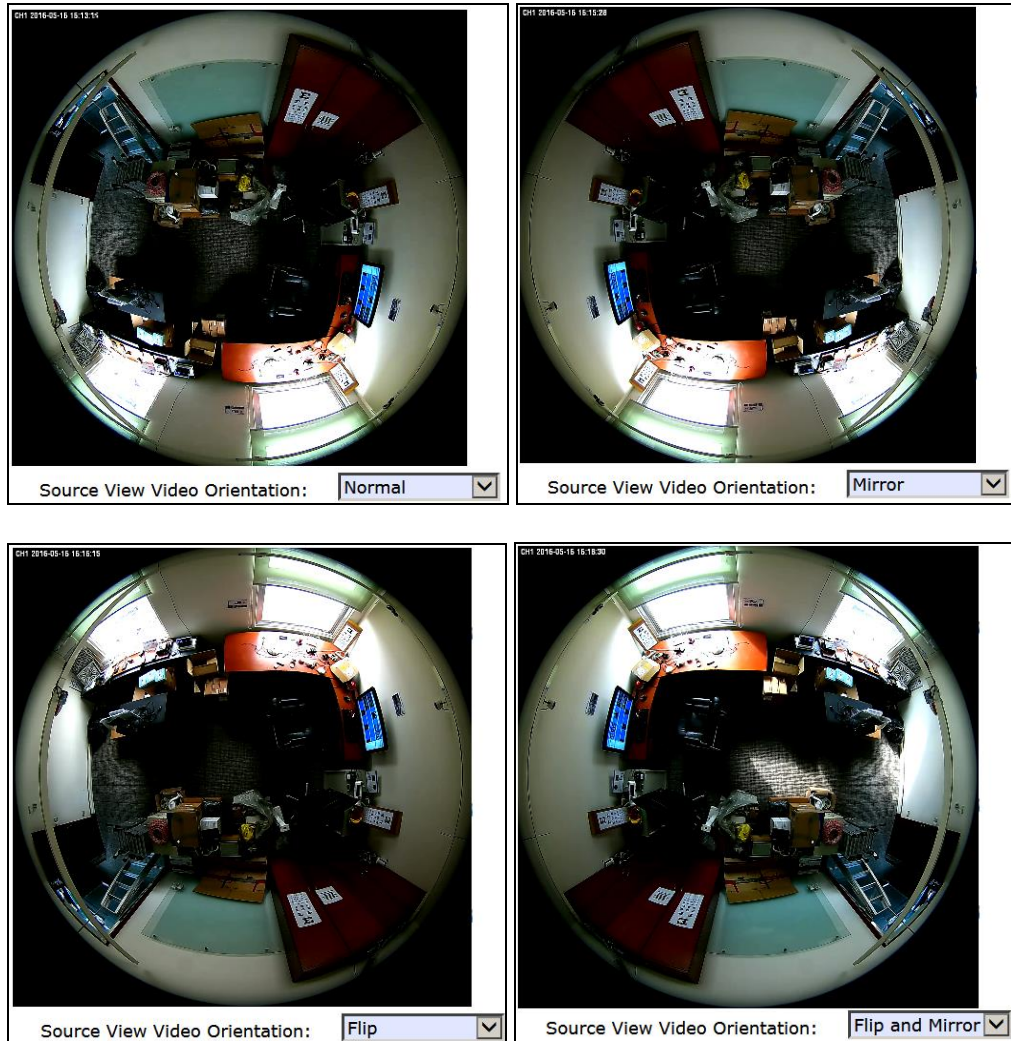

Below there are **Advanced Settings** adjustments, you could set image parameters of Fisheye Lens.

### Advanced Settings:

**Day/Night Threshold:** Set the illumination lux value (5 ~ 100) to auto-trigger the Camera into “day” or “night” mode relative to luminance of the area under surveillance. When the environment luminance becomes higher than the set lux value, the Camera will auto switch to “day” or “color” mode. Otherwise, it will remain at “night” or “mono” mode.

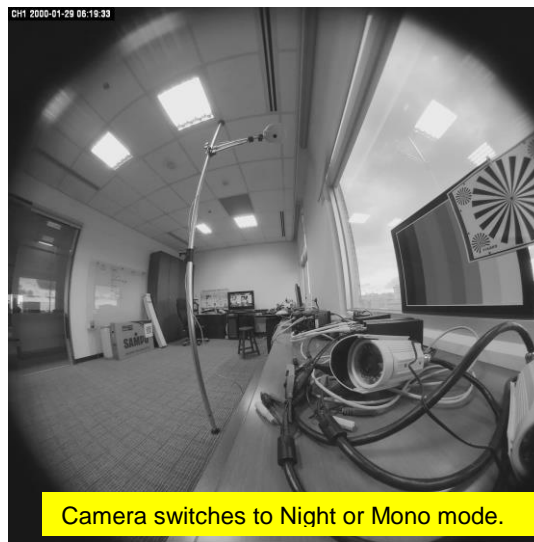

**Schedule:** Usually camera will switch to Day/Night mode automatically according to the ambient light level detected by Light Sensor component.



*If camera is installed in too dark or too bright environment (**Light Sensor function is inactive**), user could rely on this option to define the start time to of Day/Night mode.*

<input checked="" type="checkbox"/> Schedule	
Day:	05 : 00 (hh:mm)
Night:	18 : 00 (hh:mm)

## 4.3.2 Stream Tab

Video	Stream	Audio	Privacy Mask	Fisheye Settings
<b>Video quality settings for stream 1</b>				
Connection template:	Customized			
Mode:	H264			
Frame Size:	1920x1920			
Maximum Frame Rate:	15 FPS			
Streaming Mode:	CBR(CVBR)			
Bitrate:	6 Mbps			
Intra frame period:	15			
<input checked="" type="checkbox"/> Text Overlay				
Text Field:	CH1			
<input checked="" type="checkbox"/> Time Stamp				
RTSP Port Access Name:	live1.sdp			
<b>Video quality settings for stream 2</b>				
Connection template:	Customized			
Mode:	H264			
Frame Size:	1600x1200			
Maximum Frame Rate:	15 FPS			
Streaming Mode:	CBR(CVBR)			
Bitrate:	2 Mbps			
Intra frame period:	15			
<input checked="" type="checkbox"/> Text Overlay				
Text Field:	CH2			
<input checked="" type="checkbox"/> Time Stamp				
RTSP Port Access Name:	live2.sdp			
<b>Video quality settings for stream 3</b>				



### NOTE

If the “Event Alarm Setting” (see Section 4.4.2 & 4.4.3) is enabled, an alert message will display requiring you to **disable the feature first before proceeding to change the Streaming settings**. Otherwise, adjustments to video quality streaming settings **cannot** be accomplished.

The **Stream** tabbed pane provides the adjustments for the video quality of the Camera streaming function. The setting items on this pane are as follows:

**Video quality settings for stream #:** Stream 1 is the primary quality setting for live view streaming. Other stream # is the secondary and third quality setting for live view streaming.

**Connection template:** Four option modes are available; “Fast,” “General,” “Low,” and “Customized” modes.

**Mode:** Three modes of encoding options are offered; “H264,” “MJPEG,” and “MPEG4.”

**Frame Size:** “1920x1920,” “1920x1080,” and “1600x1200”, 3 types of streamed frame resolutions are available to select.

**Maximum Frame Rate:** Available rate options are; 1, 2, 3, 5, 8, 10 & 15 frames per second (FPS).

**Steaming Mode:** Two choices of streaming modes are offered; “CBR (CVBR)”, “CBR (VQCB)” and “VBR (variable bit rate)”.

Ⓒ **CVBR:** If the provided bit rate is not exceeded, the video is encoded with provided quality factor. If it exceeds, the video quality will be varied to meet the provided bit rate while the frame rate is kept constant.

Ⓒ **VQCB:** The video quality and the frame rate will be variable to meet the provided bit rate.

**Quality/Bitrate:** The options for streaming mode quality are expressed differently between VBR and CBR:

Ⓒ **VBR:** Standard, Good, & Detailed

Ⓒ **CBR:** 64K bps, 128K bps, 184K bps, 200K bps, 256K bps, 384K bps, 512K bps, 768K bps, 1M bps, 1.5M bps, 2M bps, 3M bps, 4M bps, 5M bps, 6M bps, 8M bps, 10M bps and 12M bps.

**Intra frame period:** Available choices are; 1, 2, 3, 4, 5, 8, 10, 15, 20, 25, 30, 40, 50 & 60 frames per period. This function will let you choose how long distance between two I-Frames. Lager value means longer distance between two I-Frames and this selection is suitable for the stable Network Bandwidth Environment; so we suggest the smaller value selection is proper to the worse Network Bandwidth Environment.

**Text Overlay:** When enabled, each streamed frame will be overlaid with the Camera ID (text field, Chinese word isn't support) and stamped with date/time (if enabled) as illustrated below.

<input checked="" type="checkbox"/> Text Overlay	
Text Field:	<input type="text" value="CH1"/>
<input checked="" type="checkbox"/> Time Stamp	

**RTSP Port Access Name:** When RTSP or VLC media-player is used, the port can be renamed with easy to remember pathname.

For example: the default RTSP Port Access Name is live1.sdp ; it means your playback stream name would be “RTSP://camera’s IP address/live1.sdp”.

Video	Stream	Audio	Privacy Mask	Fisheye Settings
<b>Video quality settings for stream 1</b>				
Connection template:	<input type="text" value="Customized"/>			
Mode:	<input type="text" value="H264"/>			
Frame Size:	<input type="text" value="1920x1920"/>			
Maximum Frame Rate:	<input type="text" value="15"/> FPS			
Streaming Mode:	<input type="text" value="CBR(CVBR)"/>			
Bitrate:	<input type="text" value="6 Mbps"/>			
Intra frame period:	<input type="text" value="15"/>			
<input checked="" type="checkbox"/> Text Overlay				
Text Field:	<input type="text" value="CH1"/>			
<input checked="" type="checkbox"/> Time Stamp				
RTSP Port Access Name:	<input type="text" value="live1.sdp"/>			



After setups are completed, click **Save** button to implement the settings.



### 4.3.3 Audio Tab



The **Audio** tabbed pane provides the following audio adjustments to your Camera microphone and speaker:

- Type:** Select which kind of codec you would like to set as Audio-In signal output format.
- Mute:** Enable or disable mute function of the Camera's Audio-In signal.
- Gain +20dB:** Enable or disable **Gain +20dB** function of the Camera Audio-In signal. Enable this function will amplify the signal from the Audio-In signal.



After setups are completed, click **Save** button to implement the settings.

### 4.3.4 Privacy Mask Tab

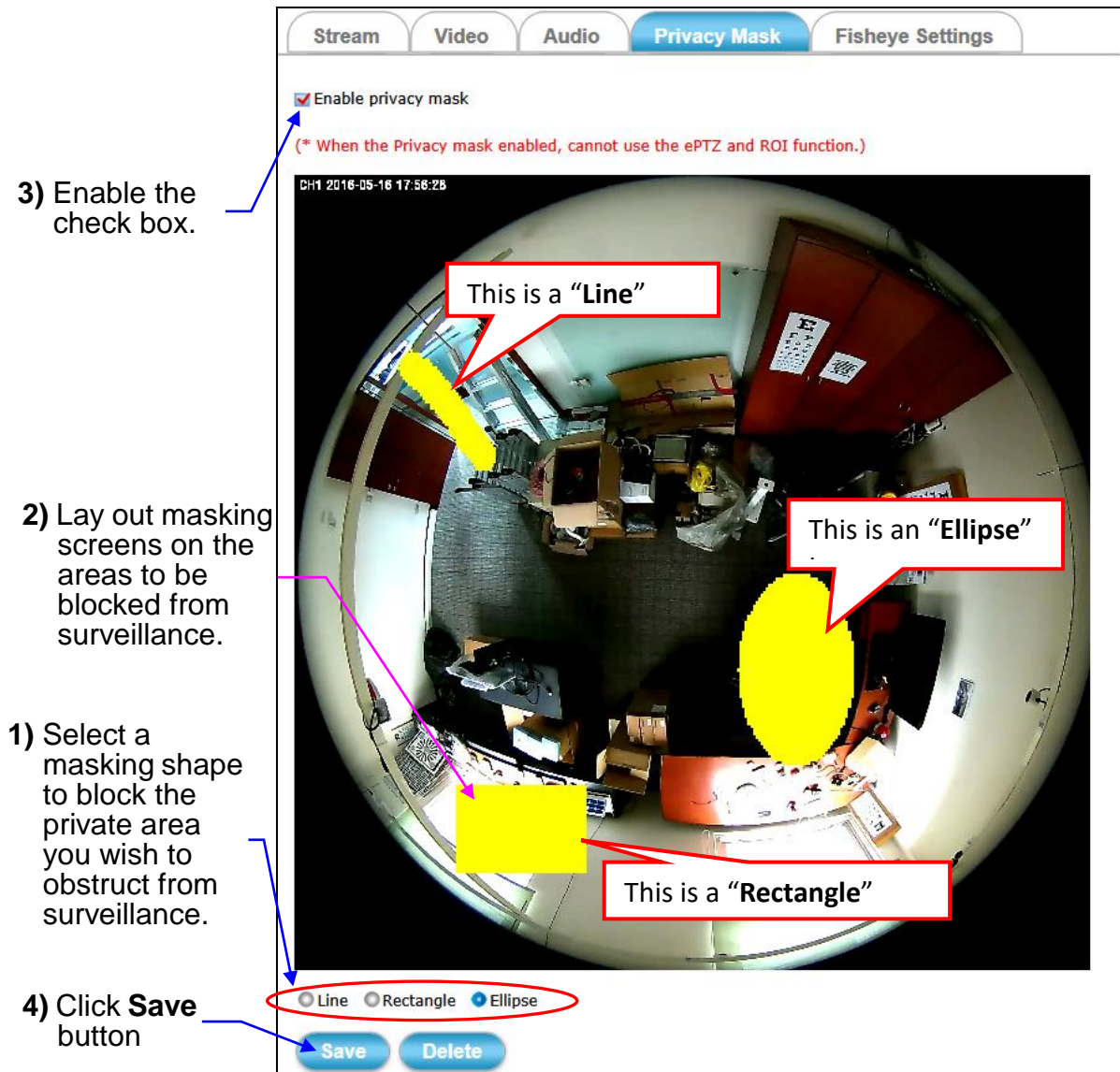

The **Privacy Mask** tabbed pane allows you to mask or block private areas from surveillance for privacy reason.

#### ■ The steps to block a private area from surveillance:

- 1) Initially select the masking shape, e.g., “Line,” “Rectangle,” or “Ellipse” (see figure above) you wish to use as screen to block the area from surveillance.
- 2) Click and drag the mouse cursor to lay out a masking screen on the area you wish to block, and then release the mouse right button. Notice that the laid out screen turns into phantom block.

Delete

- 3) Once the masking screen is acceptable, click the **Enable Privacy Mask** check box. If the laid out screen needs correction, click **Delete** button and redo the masking screen lay out process.

Save

- 4) Click the **Save** button. This will turn the laid out screen into solid block.

■ **The steps to disable masking and remove the screen:**

- 1) Click **Delete** button.
- 2) Click **Save** button and wait a while. Then the screen is permanently removed.

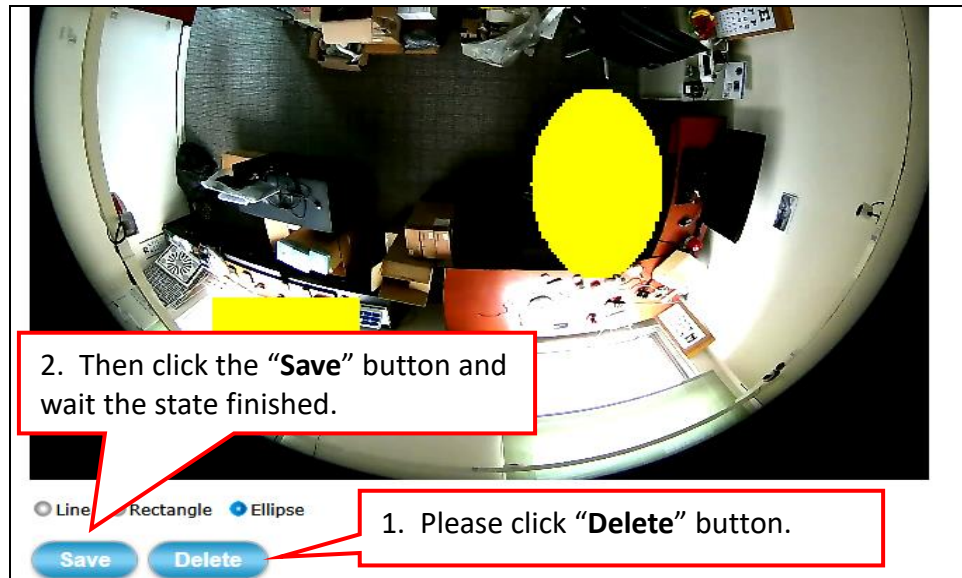

- 3) To permanently disable the **Privacy Mask** function, disable the **Enable Privacy Mask** check box

### 4.3.5 Fisheye Settings Tab

The screenshot shows a settings window with five tabs: Stream, Video, Audio, Privacy Mask, and Fisheye Settings. The Fisheye Settings tab is active. Under 'Capture Mode', 'Circular fisheye' is selected. Under 'Mount Type', 'Ceiling' is selected in the dropdown menu. A 'Save' button is at the bottom.

The **Fisheye Setting** tabbed pane allows you to set video modes captured by fisheye lens:

- Full-image:** Means video pass through lens to sensor directly, without crop. In this mode, **2592x1944@10fps** is supported maximally.
- Circular fisheye:** Means video would be dewrap by Hardware Fisheye Correction Processor; support **1920x1920@15fps** maximally. And this mode supports Ceiling and Wall mount types.
- Full-frame fisheye:** Raise to 30 frames per second and the max resolution value is **1600x1200@30fps**.



After setups are completed, click **Save** button to implement the settings.

## 4.4 Event Setup



Clicking the **Event** button will display the tabbed panes (see figure below) for defining event recording of the Camera.

The iCAM-771 is equipped with a card slot for microSD / microSDHC / microSDXC 64GB memory card.

This storage card is utilized to store recording of local video and still JPEG images taken in response to set events. The recording operation of events is triggered according to the defined schedules.

The screenshot shows the web interface for the iCAM-771. On the left is a "Setup" sidebar with buttons for Live View, System, Network, Video &amp; Audio, Event (highlighted in blue), Local Storage, and Remote Storage. The main area has tabs for Motion, Video, Snapshot, and GPIO. The "Motion Settings" section is active, showing a checkbox for "Enable Motion Detection" which is checked. Below this is a live video feed of a metallic sphere. At the bottom of the video feed are buttons for "Add", "Delete", "Save", and "Refresh". A note below the buttons states: "(Note: The maximum number of motion detections is 10. Set New Motion Detection Area : 1. Click 'Add' and rename the windows area. 2. Drag a detection area on the image.)"

## 4.4.1 Motion Tab

From the **Motion** tabbed pane, you can define specific target areas within the scope of surveillance to focus the motion detection function.

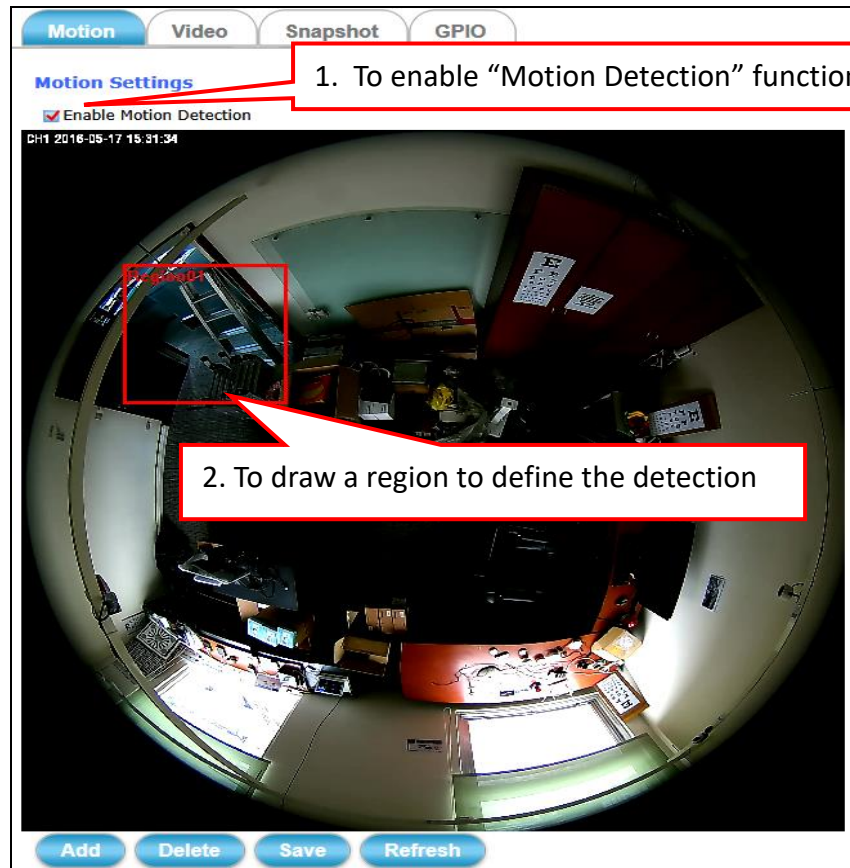

### ■ Defining a single motion detection area:

Add

- 1) Enable the **Enable Motion Detection** check box.
- 2) Click **Add** button and a default frame **Region00** will pop-up on the screen.
- 3) Click and hold inside the frame to drag it to the location where you want to focus detection. Resize the frame by dragging its corners or borders.
- 4) Click the **Save** button to apply.

Save

### ■ Defining multiple motion detection areas:

Add

- 1) After satisfactory positioning of the first detection area as described above, click the **Add** button again. A second default frame will pop-up on the screen. Drag & resize the frame at the desired location.
- 2) Repeat the above step to add more detection area frames.



### NOTE

*Total defined motion detection areas cannot exceed 10 windows(regions).*

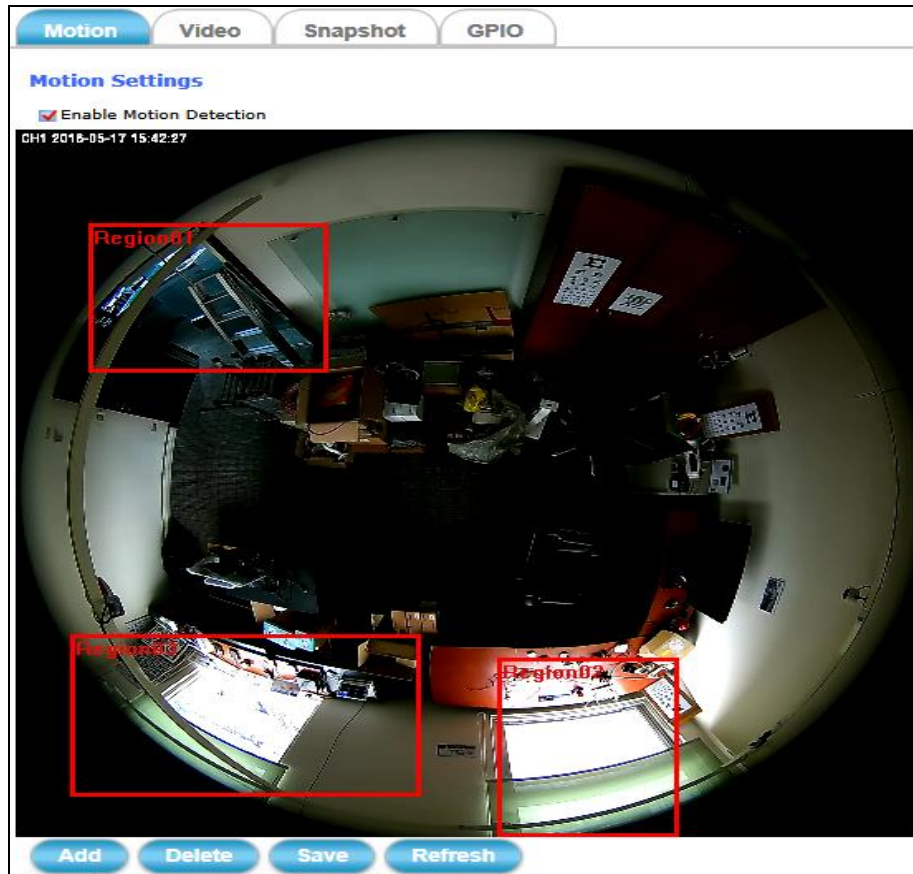

- 3) To assign unique names to each framed location for easy identification, click on the frame and a **Window Name** text box with the default name of the selected frame, will appear at the bottom of the pane (see figure below). Enter a new name and click the **Save** button. Wait for a while for the change to take effect.

Save

Window Name:	<input type="text" value="Region04"/>		
Trigger Level:	<input type="range" value="85"/>	85	(0~100, Low~High)
Sensitivity:	<input type="range" value="85"/>	85	(0~100, Low~High)

- 4) To delete a frame that is no longer needed but was previously saved, click on the unwanted frame and click **Delete** button. The frame will disappear after a while.
- 5) To delete multiple frames that are not yet saved, directly click the **Refresh** button instead of deleting them individually. The **Refresh** button will automatically clears all unsaved frames.

Delete

Refresh

## 4.4.2 Video Tab

The Video tabbed pane sets the video recording trigger method, the four methods available for selection are Schedule, Period, Motion is detected by the Camera, and GPIO Input, each of which can be set up with user scheduled recording time and duration, as well as defining the video record file target destination.

- Schedule:** This method activates the Camera video surveillance/recording operation continuously when the defined days of the week and set time of the set days are met. Motion is ignored with this method. Each recording time-span is in accordance with the setting value of Post event recording (in seconds) and the video record is stored in the SD card, Remote Disk as selected or through both of them.

Motion
Video
Snapshot
GPIO

**Event Alarm Settings by Video**

(\*Please note that there is no SD Card plugged in camera or the SD Card is not writable.)

Schedule / Period Recording

Schedule

Day:

Sun  MON  Tue  WED  Thu  FRI  Sat

Time:

Start  :  (hh:mm) End  :  (hh:mm)

Recording Length:  Seconds

Target:

SD card

Remote Disk



- **Period:** This method will trigger the Camera video surveillance/recording operation for a defined Time Lapse (in seconds) whenever motion is detected. The video record may be stored in the SD card, Remote Disk, provided to host by E-mail/FTP as selected or through all of them.

Motion Video Snapshot GPIO

### Event Alarm Settings by Video

(\*Please note that there is no SD Card plugged in camera or the SD Card is not writable.)

Schedule / Period Recording

Schedule

Period

Recording Length:  Seconds

Time Lapse:  Seconds

Target:

SD card

E-mail / FTP

Remote Disk

- Motion:** This method will trigger the Camera video surveillance/recording operation whenever motion is detected within the defined days of the week and at the time of the set days.  
 Each recording time-span is in accordance with the total value of Pre-event recording and Post event recording (in seconds). And the video record may be stored in the SD card, Remote Disk, provided to host by E-mail/FTP, activated GPIO Output Port as selected or through all of them.

Motion
Video
Snapshot
GPIO

### Event Alarm Settings by Video

(\*Please note that there is no SD Card plugged in camera or the SD Card is not writable.)

Schedule / Period Recording

Motion (Link to [Motion Settings](#))

Trigger Pattern:

Only during

Sun  MON  Tue  WED  Thu  FRI  Sat

Time:

Start  :  (hh:mm)    End  :  (hh:mm)

Pre-event recording:  Seconds

Post event recording:  Seconds

Target:

SD card  
 E-mail / FTP  
 Remote Disk  
 GPIO Output

- GPIO Input:** On the defined days of the week and at certain time of the set days, the Camera will be triggered by its GPIO Input Signal when its state changes.

(As for the more GPIO Signal setting, you may refer to [4.4.4 GPIO Tab](#)).

Each recording time-span is in accordance with the total value of Pre-event recording and Post event recording (in seconds). And the video record may be stored in the SD card, Remote Disk, provided to host by E-mail/FTP, activated GPIO Output Port as selected or through all of them.

Motion
Video
Snapshot
GPIO

### Event Alarm Settings by Video

(\*Please note that there is no SD Card plugged in camera or the SD Card is not writable.)

Schedule / Period Recording

Motion (Link to [Motion Settings](#))

GPIO Input

Day:

Sun
  MON
  Tue
  WED
  Thu
  FRI
  Sat

Time:

Start  :  (hh:mm)
 End  :  (hh:mm)

Pre-event recording:  Seconds

Post event recording:  Seconds

Target:

SD card  
 E-mail / FTP  
 Remote Disk  
 GPIO Output

**E-mail Settings**

Recipient E-mail Address:  (ex: rcpt@mail.com )

SMTP E-mail Server:  (ex: mail.examples.com or 192.168.1.1 )

Port:  (0..65535)

User Name:

Password:

Sender E-mail Address:  (ex: from@mail.com )

Use SSL-TLS:  ▼

**Test E-mail**

**FTP Settings**

FTP Server:  (ex: ftp.domain.com or 192.168.1.1)

FTP Server Port:  (0..65535)

User Name:

Password:

Path:  (ex: \ftp\upload )

Upload to the root directory

Filename Prefix:  (ex: event )

**Test FTP**

**E-mail Settings:** As for the settings of SMTP Service, kindly please contact with your E-mail service provider. After you confirm all parameters are correct and working properly, you may enter them into the text area manually.

**FTP Settings:** As for the settings of FTP Service, kindly please contact with your FTP service provider. While all parameters filled in Windows FTP Transferring Utility are correct and working properly under your Laptop or other PC, you may enter them into the text area manually.



© **Filename Prefix:** the filename will show as “Prefix” “date” “time”.  
EX: Set the Prefix as “771avi”, and the file name will show as “771avi\_20170615151326.jpg”. The files are saved in folders named by date and sub-folders named by time.



After setups are completed, click **Save** button to apply the settings.

### 4.4.3 Snapshot Tab

The Snapshot tabbed pane sets the Camera to take snapshot images when event is triggered. The four methods available for selection are Always, Schedule, Motion, and GPIO Input, each of which can be set up with user scheduled time and capture interval, as well as defining the snapshot file target destination.

- **Always:** Under this method, the Camera automatically continuous to capture snapshots of the area under surveillance at every 1, 2 or 3 seconds interval. The stream of accumulated snapshots may be stored in the SD Card, Remote Disk, sent to host by E-mail, FTP as preferred or through all of them.



**Event Alarm Settings by Snapshot**

(\*Please note that there is no SD Card plugged in camera or the SD Card is not writable.)

Always / Schedule

Always

Time Lapse:  Seconds

Target:

SD card

E-mail

FTP

Remote Disk

Snapshot is triggered at every 1, 2 or 3 seconds interval.

- Schedule:** This method activates the Camera snapshot operation continuously when the defined days of the week and set time of the set days are met. The Camera will continuously capture snapshots of the area under surveillance at every 1, 2 or 3 seconds intervals. The stream of accumulated snapshots may be stored in the SD Card, Remote Disk, sent to host by E-mail, FTP as preferred or through all of them.

Motion
Video
Snapshot
GPIO

### Event Alarm Settings by Snapshot

(\*Please note that there is no SD Card plugged in camera or the SD Card is not writable.)

Always / Schedule

Always

Schedule

Day:

Sun
  MON
  Tue
  WED
  Thu
  FRI
  Sat

Time:

Start  :  (hh:mm) End  :  (hh:mm)

Time Lapse:  Seconds

Target:

SD card  
 E-mail  
 FTP  
 Remote Disk

Snapshot is triggered at every 1, 2 or 3 seconds interval.

- Motion:** This method will trigger the Camera snapshot operation according to the set time interval (in seconds) whenever motion is detected within the defined days of the week and at the time of the set days. Single or 6 snapshots may be captured as defined. The stream of accumulated snapshots may be stored in the SD Card, Remote Disk, sent to host by E-mail、FTP, activated GPIO Output Port as preferred or through all of them.

**Event Alarm Settings by Snapshot**

(\*Please note that there is no SD Card plugged in camera or the SD Card is not writable.)

Always / Schedule

Motion (Link to Motion Settings)

Trigger Pattern:

Only during

Sun  MON  Tue  WED  Thu  FRI  Sat

Time:

Start  :  (hh:mm) End  :  (hh:mm)

Interval:  ( minimum is 3 seconds )

Single snapshot

6 snapshot with  second interval (3 frames before and 3 frames after motion frame)

Target:

SD card

E-mail

FTP

Remote Disk

GPIO Output

User could select "Single snapshot" or "6 snapshot..."

- GPIO Input:** This method will trigger the Camera snapshot operation according to the set time interval (in seconds) whenever GPIO Input Signal is detected within the defined days of the week and at the time of the set days.  
 (As for the more GPIO Signal Settings, you may refer to [4.4.4 GPIO Tab](#))

Motion
Video
Snapshot
GPIO

### Event Alarm Settings by Snapshot

(\*Please note that there is no SD Card plugged in camera or the SD Card is not writable.)

Always / Schedule  
 Motion (Link to [Motion Settings](#))  
 GPIO Input

Day:

Sun  MON  Tue  WED  Thu  FRI  Sat

Time:

Start  :  (hh:mm) End  :  (hh:mm)

Interval:  ( minimum is 3 seconds )

Single snapshot  
 6 snapshot with  second interval (3 frames before and 3 frames after motion frame)

Target:

SD card  
 E-mail  
 FTP  
 Remote Disk  
 GPIO Output

The stream of accumulated snapshots stored in the SD Card, Remote Disk, sent to host by E-mail、FTP, activated GPIO Output Port as preferred or through all of them. When E-mail/FTP target is selected, the illustration of these methods setup dialog will display in the following figure.



**E-mail Settings**

Recipient E-mail Address:  (ex: rcpt@mail.com )

SMTP E-mail Server:  (ex: mail.examples.com or 192.168.1.1 )

Port:  (0..65535)

User Name:

Password:

Sender E-mail Address:  (ex: from@mail.com )

Use SSL-TLS:  ▼

**FTP Settings**

FTP Server:  (ex: ftp.domain.com or 192.168.1.1)

FTP Server Port:  (0..65535)

User Name:

Password:

Path:  (ex: \ftp\upload )

Upload to the root directory

Filename Prefix:  (ex: event )

**E-mail Settings:** As for the settings of SMTP Service, kindly please contact with your E-mail service provider. After you confirm all parameters are correct and working properly, you may enter them into the text area manually.

**FTP Settings:** As for the settings of FTP Service, kindly please contact with your FTP service provider. While all parameters filled in Windows FTP Transferring Utility are correct and working properly under your Laptop or other PC, you may enter them into the text area manually.



© **Filename Prefix:** the filename will show as “Prefix” “date” “time”.  
EX: Set the Prefix as “771snap”, and the file name will show as “771snap\_20170615151326.jpg”. The files are saved in folders named by date and sub-folders named by time.



After setups are completed, click **Save** button to apply the settings.

### 4.4.4 GPIO Tab

The **GPIO** tabbed pane allows you to set GPIO Input Signal condition.

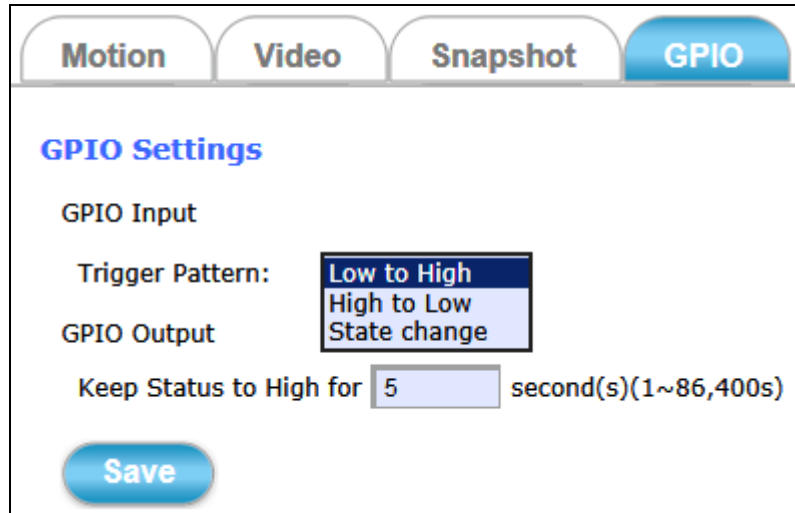

**GPIO Input:** The Trigger Pattern can decide which kind of pattern would trigger event successfully (Low to High, High to Low or State change).

**GPIO Output:** To set how long (in seconds) GPIO Output Device would be kept active high status.



Then click the **Save** button to take effect the change.

## 4.5 Local Storage Setup



Clicking the **Local Storage** button will display the following tabbed panes to provide information on existing local storage, such as disk size info, type, and status. If recording is in progress when clicking the **Local Storage** button, a warning message will occur.

**Setup**

- Live View
- System
- Network
- Video & Audio
- Event
- Local Storage**
- Remote Storage

**Local Storage** | Playback

**SD card management**

SD card status: SD\_DETACHED

Total size:	0 KBytes	Free size:	0 KBytes
Used size:	0 KBytes	Use(%):	0 %

Recording status:

SD card control:

Enable cyclic storage

Keep Free Space:  MB ( 30~500 MB )

(\*Please note that there is no SD Card plugged in camera or the SD Card is not writable.)

Save      Format      Refresh



### NOTE

*Do NOT remove the micro SD card while Camera is in recording process.*

## 4.5.1 Local Storage Tab

The **Local Storage** tabbed pane displays the SD card status. It shows the SD card total capacity (Total size), available memory (Free size), used memory (Used size) and used memory ratio (Use(%)). It also displays the current Camera operation condition (Recording status) and provides “SD card control” option where user can select to allow the Camera to auto-overwrite earlier files in order to maintain the defined “Keep Free Space” memory size.

The screenshot shows the 'Local Storage' tab with the following information:

- SD card management**
- SD card status: OK
- Total size: 15756768 KBytes
- Free size: 13913392 KBytes
- Used size: 1843376 KBytes
- Use(%): 12 %
- Recording status: Not Recording
- SD card control:
  - Enable cyclic storage
  - Keep Free Space: 64 MB ( 30~500 MB )
- (\*Please stop all the events related to the SD card recording before ejecting or formatting the SD card.)
- Buttons: Save, Format, Refresh

**Enable cyclic storage:** Enable check box to allow auto-overwrite of earlier files in order to maintain the defined “Keep Free Space” memory size.

**Save** : Click this button to save changes to the SD card control setting.

**Format** : Click this button to format the SD memory card (take note of the message in red).

**Refresh** : Click this button to refresh the SD card information.

## 4.5.2 Playback Tab

The **Playback** tabbed pane allows user to playback video and snapshot files stored in the SD memory card.

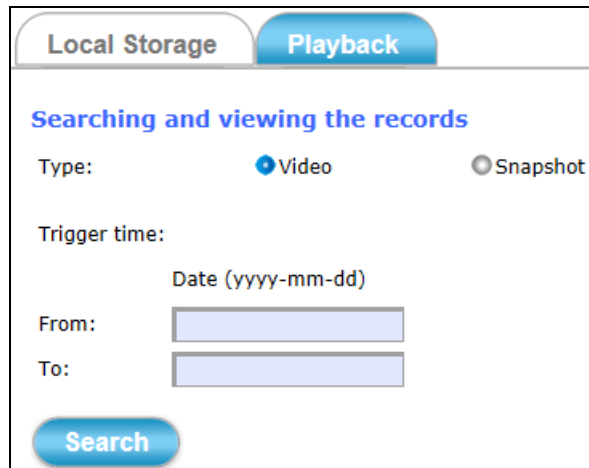

These files were saved using the Event setup for video (see [Section 4.4.2](#)) and snapshots ([Section 4.4.3](#)) with the **SD card** check box enabled. Playback of the stored videos or snapshots is performed from files recorded on particular date range as explained in the following figure.

- 1) Select the **Type** of **Video** or **Snapshot**.
- 2) Select the **Trigger time**: give the “from” and “to” dates for searching the files in the SD card.
- 3) Click **Search** button and the files recorded within the date range will display below.

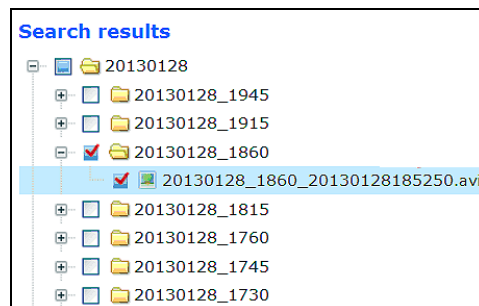

- 4) Select the file to playback and enable the corresponding check box. The dialog strip below will then pops up.

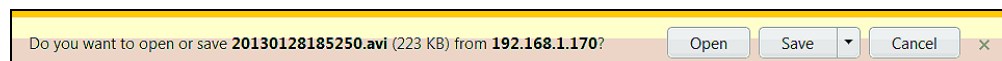

- 5) Click **Open** button will playback the file.  
Click **Save** button will save file to a designated folder.

## 4.6 Remote Storage Setup

Remote Storage

Clicking the **Remote Storage** button will display the following tabbed panes to provide information of Remote Disk.

### 4.6.1 Remote Storage Tab

The **Remote Storage** tabbed pane displays the Remote Disk information of NFS/SMBFS Server. It shows the total capacity (Total size), available memory (Free size), used memory (Used size) and used memory ratio (Use(%)) of server disk. Where:

**Enabled:** Check **Enabled** box when setup the setting to start Remote Disk Recording.

**Type:** NFS and SMBFS two kind of Remote Server are provided.

**Remote Folder Path:** If **NFS** Server type is selected, shared folder path will be filled in like “**192.168.1.1:/xxx**” syntax;  
if **SMBFS** Server type is selected, shared folder path will be filled in like “**192.168.1.1/xxx**” syntax.

**User Name:** Fill in the username for authentication of Remote Server.

**Password:** Fill in the password for authentication of Remote Server.

Save

: Click this button to save changes to the setting of Remote Server.

Refresh

: Click this button to refresh the server disk’s information.

# 5 Appendix

## 5.1 Firmware Upgrade and Trouble Shooting

This section mainly will instruct you how to update camera firmware step by step and trouble shooting (  ).

1. Find the camera and open its Web-based UI via CAM FINDER utility.

(Don't know the CAM FINDER? Refer to [Chapter 2.4](#))

Model Name	IP Address	MACAddress	Firmware	Subnet
760D	192.168.13.004	00-04-29-49-c6-01	A1.0.1_0702_PLA	255.2
760D	192.168.13.002	00-04-29-08-e2-66	B1.0.1_0203	255.2
760D	192.168.13.011	00-34-56-23-59-88	1.0.1_0525	255.2
760D	192.168.13.008		.2_0428_ROS	255.2
760D	192.168.13.005		2_1002h	255.2
760D	192.168.13.006		1206	255.2

Device Search  
 FW Update  
 Restore System  
 Batch Device Setting  
 Single Device Setting  
Open web  
 Language

In this step, you may have following troubles:



- If below picture is always popped even NetcamViewer is downloaded and installed successfully in your PC.

Please help to **check if your IE Browser version is 11 first.**

If it is yes, please kindly refer to the below steps to enable Compatible View settings of IE 11 Browser.

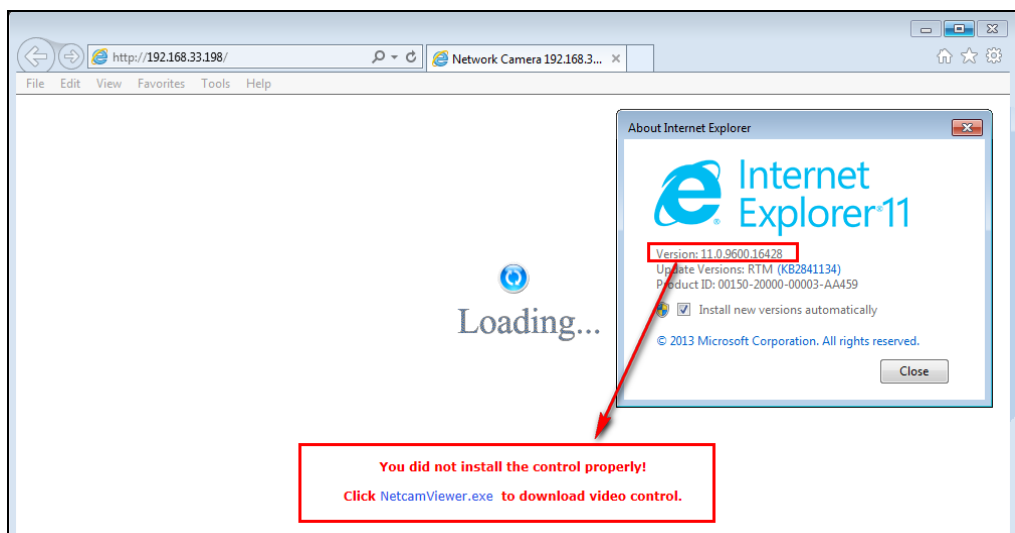

Find Tools icon and then select **Compatibility View settings**.

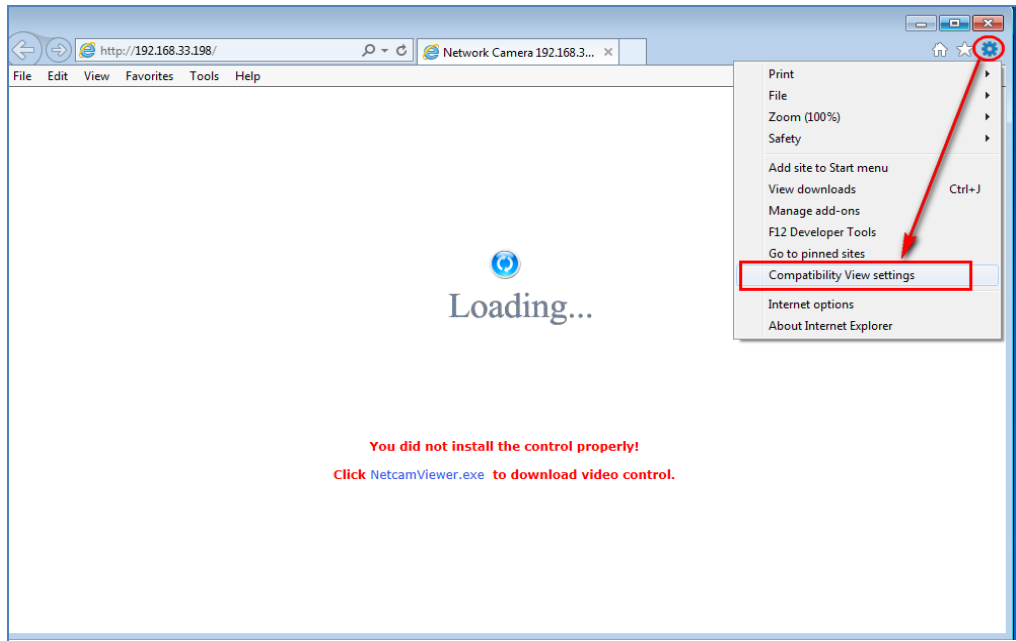

Or

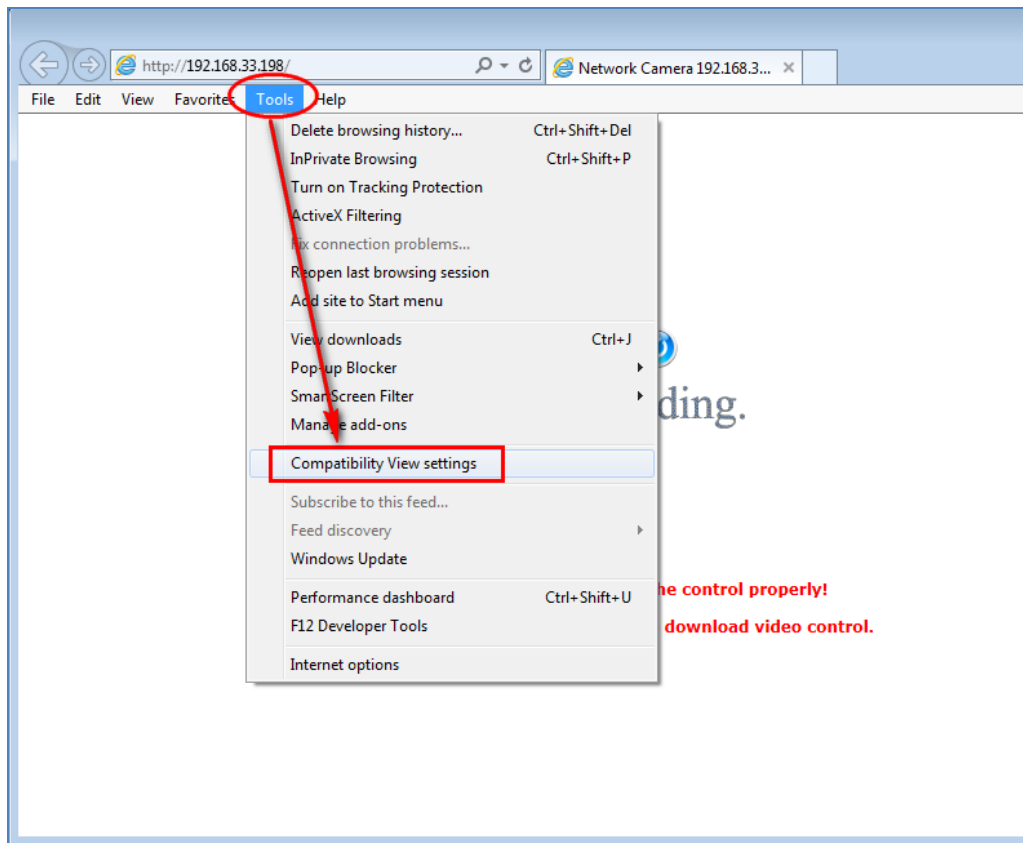



Click **Add** button to add camera webpage as a compatible website.

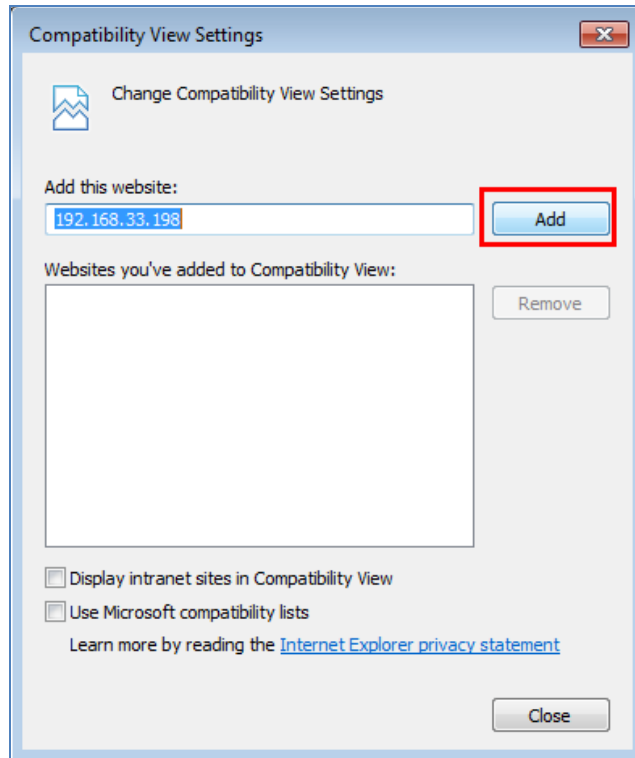

After successful adding, camera webpage should be set as compatible view website.

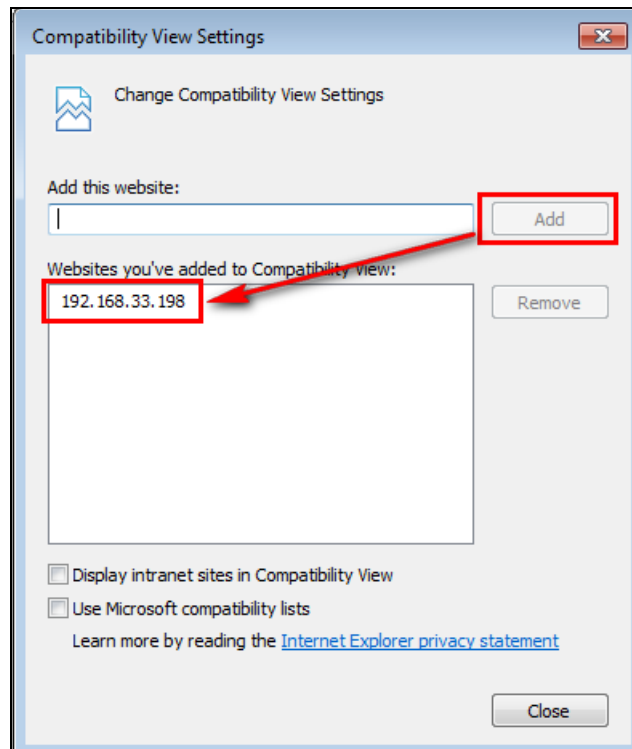

Then camera webpage would be refreshing real-time and starting to load camera webpage.

Click **Allow** button to enable NetcamViewer component running...

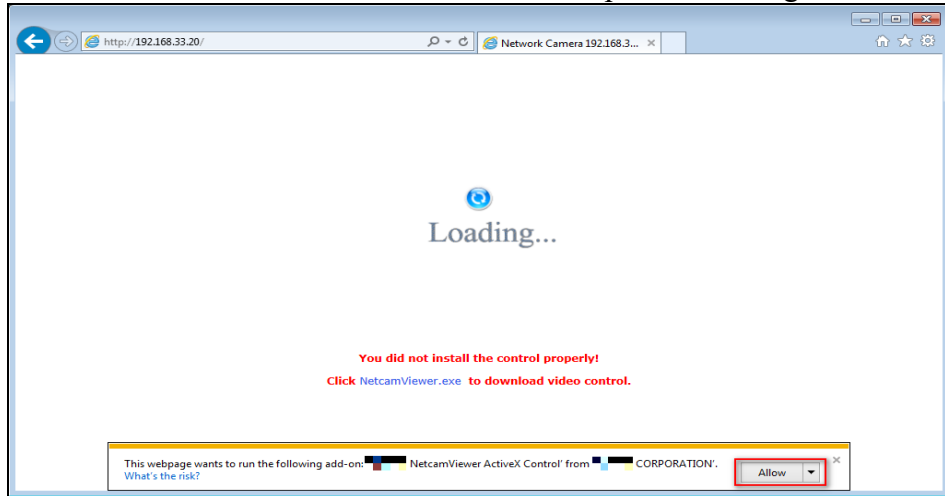

Manual enter camera's username/password to pass authentication.

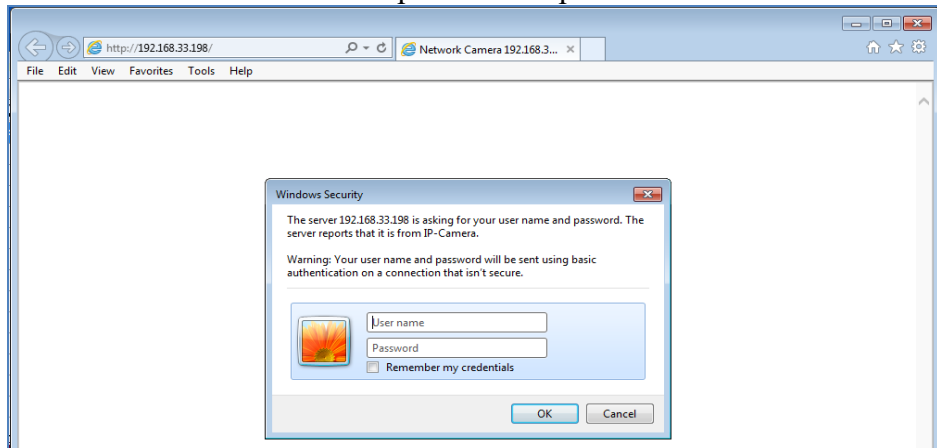

Camera live stream is successful playing in IE11 Browser

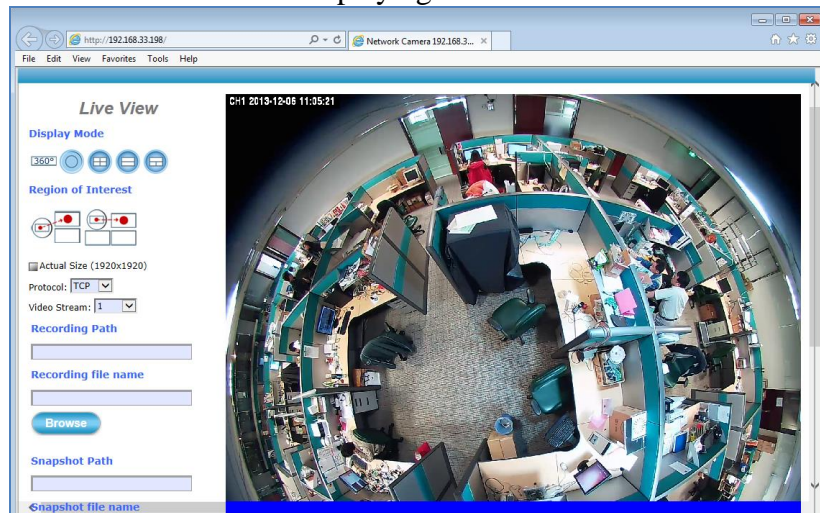



If during the NetcamViewer installation, the error message **“opening file for writing C:\Windows\system32\LibPMD.dll”** is always popped, kindly please turn off all browser windows, include CDWizard application, and then try NetcamViewer installation again.

So before NetcamViewer installation, please make sure there’s no “iexplore” process running in Windows Task Manager Window.

If there is “iexplore” process existing, select **“End Process”** to force its stop.

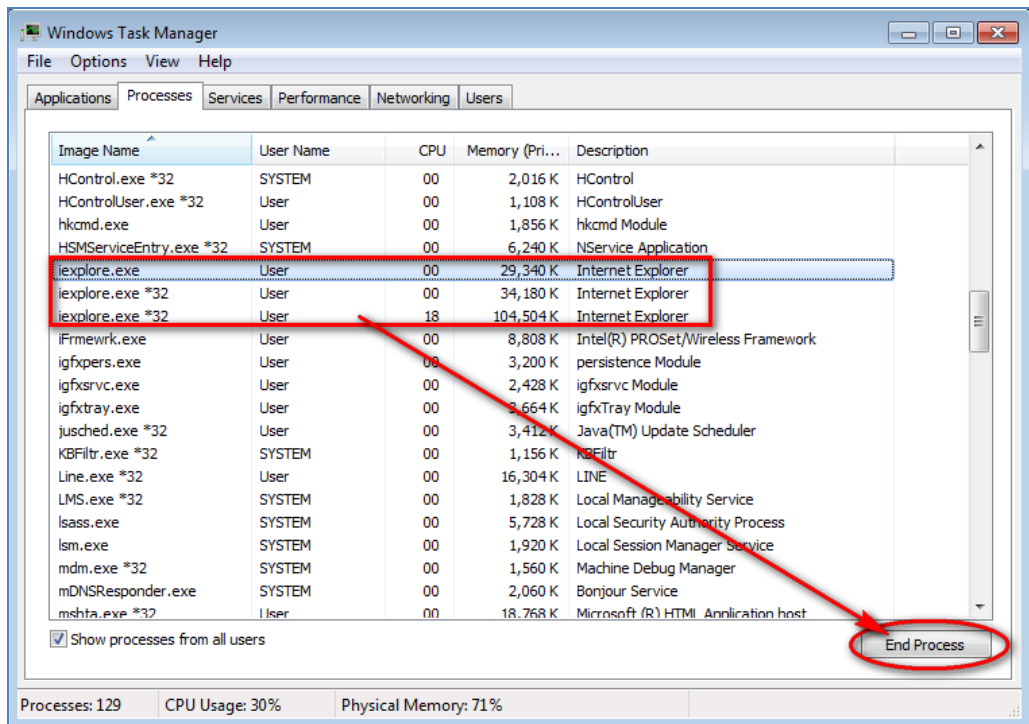



During NetcamViewer installation, you may see below prompt windows are always popped.

This will mainly remind you to *close all running browser applications* and then press “**OK**” button to continue NetcamViewer installation.

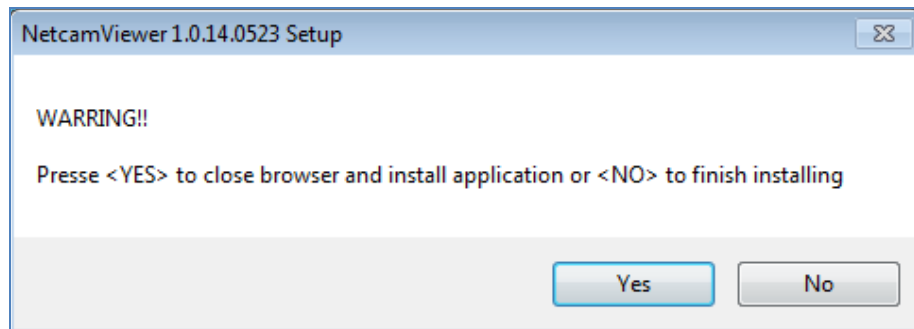
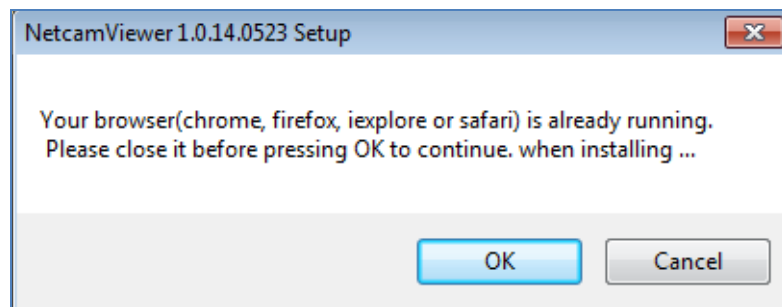

Or these two windows will pop continuously until all browsers are closed.



2. Manual input username and password of the camera to pass login authentication of camera webpage. (Default username and password are admin and admin.)
3. After Live View page is entering successfully, find the “SETUP” button. Clicking it could change or update more Camera settings.

### Live View

**Display Mode**

360°    

**Region of Interest**

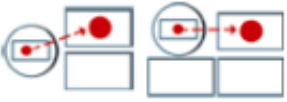

Actual Size (1920x1920)

Protocol:  

Video Stream:  



**Recording Path**

**Recording file name**

**Snapshot Path**

**Snapshot file name**

**Setting Language**

4. Find **Maintenance** Tab of Camera Setup **System** Webpage. – [Chapter 4.1.4](#).

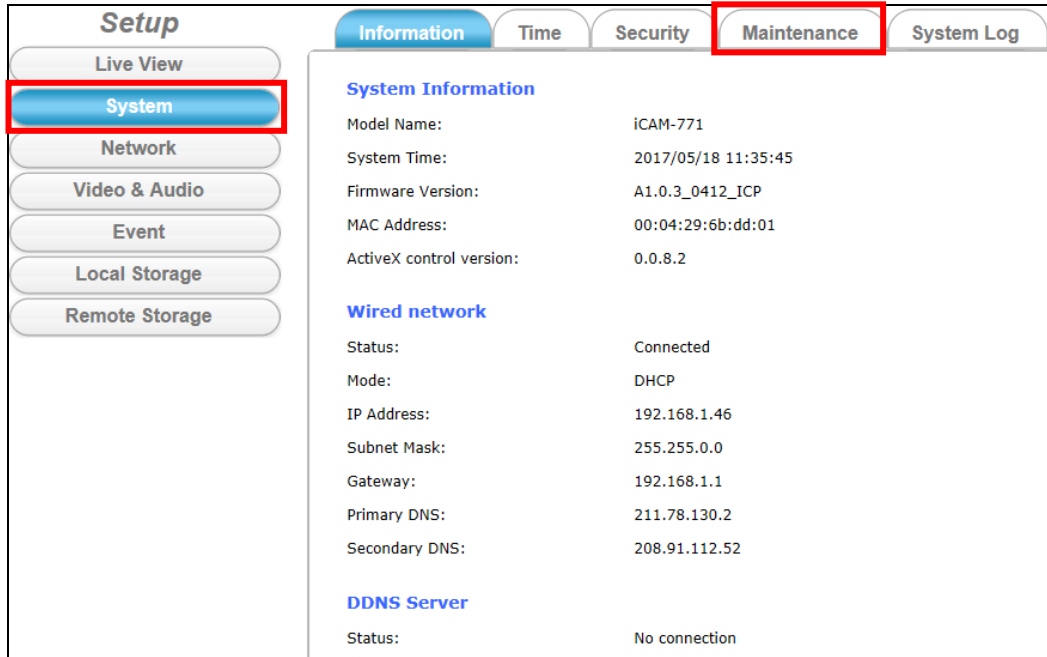

5. In order to have the best performance with Camera, kindly please ask for distributor/dealer's help to get the latest firmware version downloading.
6. After downloading it, click the **Browse** button to open the file open dialog for firmware choosing.

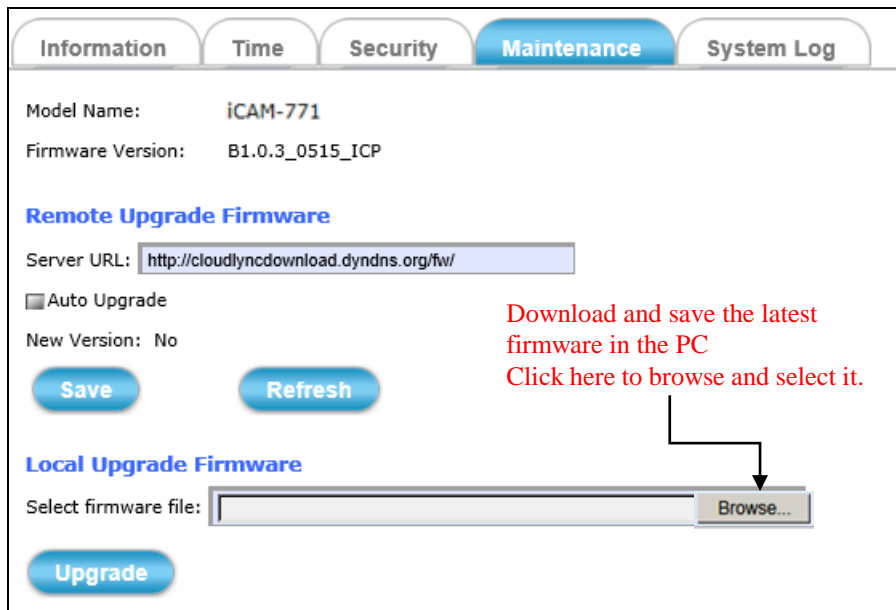

Select the **appropriate** firmware file from its folder in PC and then click **Open** button to choose it.

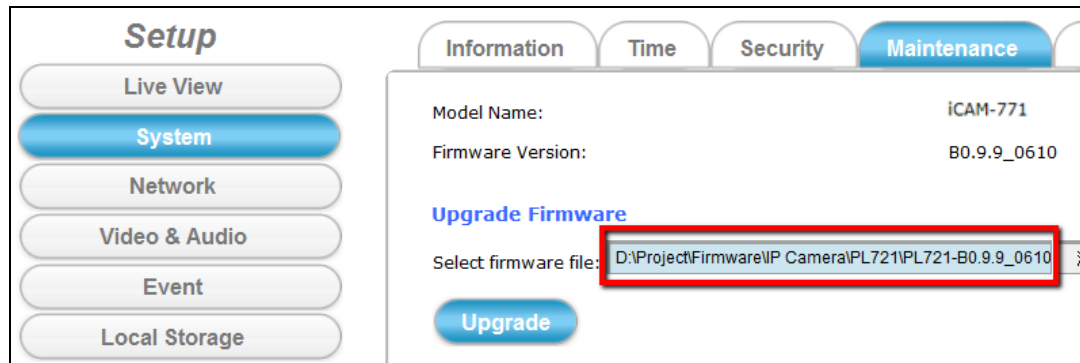

[※ Please specify the correct firmware version mapped with your camera to upgrade, or there will be danger to damage camera system.]

- Click the **Upgrade** button and then one prompt window will pop to tell you “wait about 30 seconds to stop all processes!”

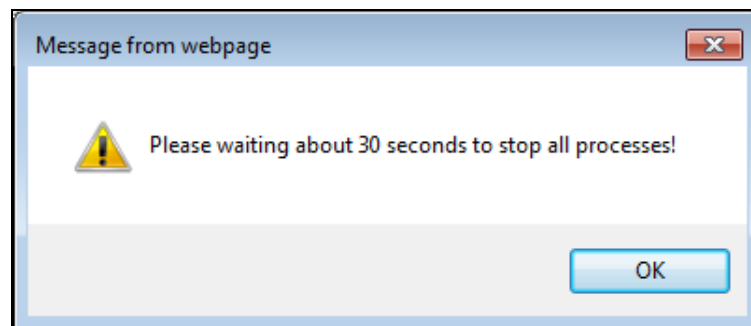

- Click the **OK** button to exit the window. Then you will see Camera Webpage is reloading, it means all processes of camera are stopping at the same time.



- After all processes are stopped, the camera will start to upgrade the firmware you chose.

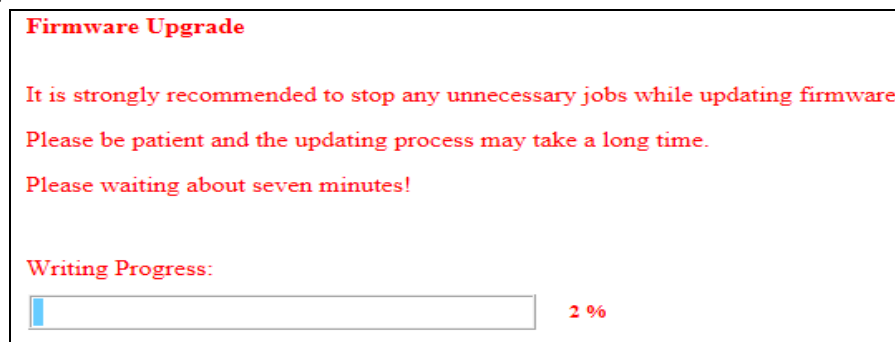

**10. Please don't power off camera or do any unnecessary jobs during firmware upgrade.**

Until the process goes to 100%, there will be messages popped to suggest you restart the Web Browser.

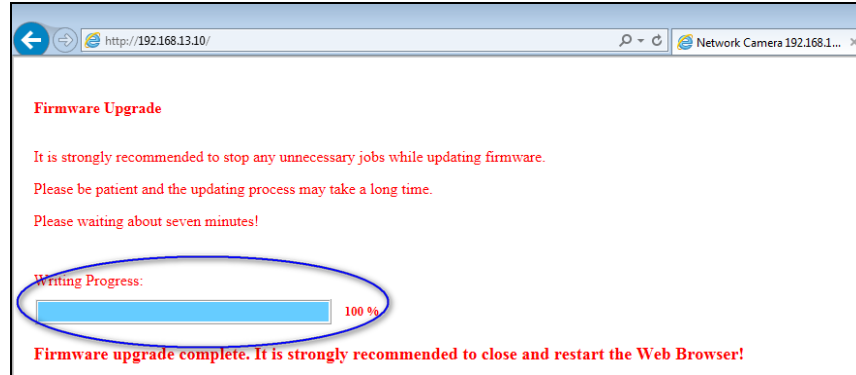

**11. While the OK button is clicked, the camera webpage connection will be closed. And then you have to re-login again.**

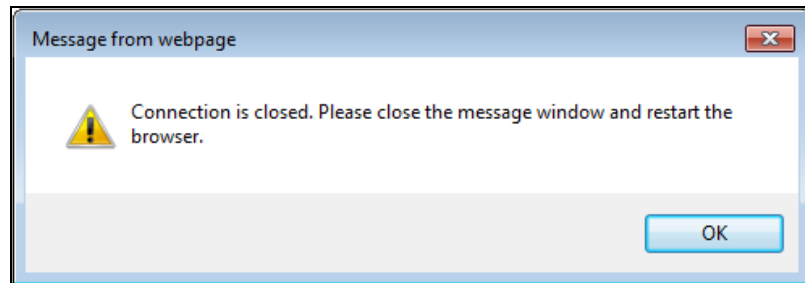

**12. After camera Web-based UI is re-login successfully, go to **Information** Tab of Camera Setup Webpage to check if the firmware version is different with before; or check if the firmware version is the same with distributor/dealer provided.**

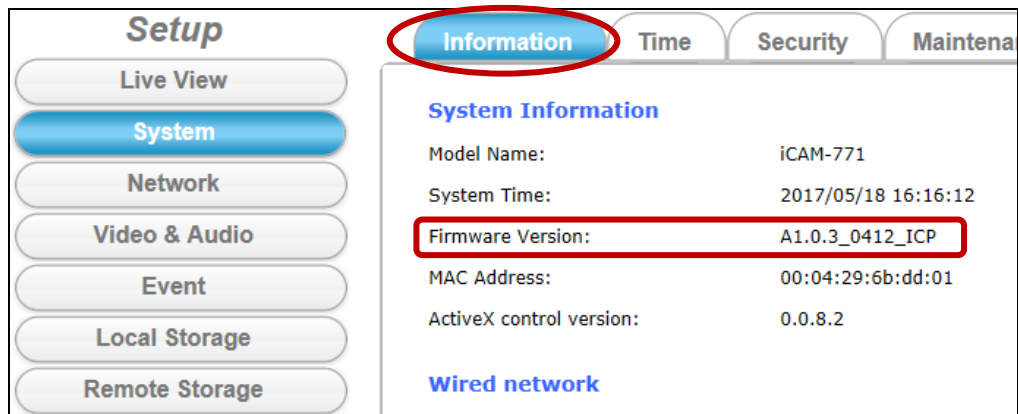



## 5.2 How to let camera to do Hardware Reset

In some cases, such as user forget login username & password they've changed before; or modify some settings to cause camera displayed image improperly; or camera system is no response & hang to the user's operation... etc., you may need to let camera to do Hardware Reset. After that, camera could reboot, operate and re-configure. The default iCAM setting after reset:

**IP: 192.168.255.2 (Default Username/Password: admin/admin)**

**Submask: 255.255.0.0**

**Gateway address: 192.168.0.1**

**DNS Server address: 8.8.8.8**

**The hardware reset steps** are as the following:

- 1) Please make sure camera is power on first.
- 2) Refer the below pin definition table of the **I/O Port Cable**; connect **Default Setting(5)** and **GND(4)** pins to short, remove the connection 10 seconds later.

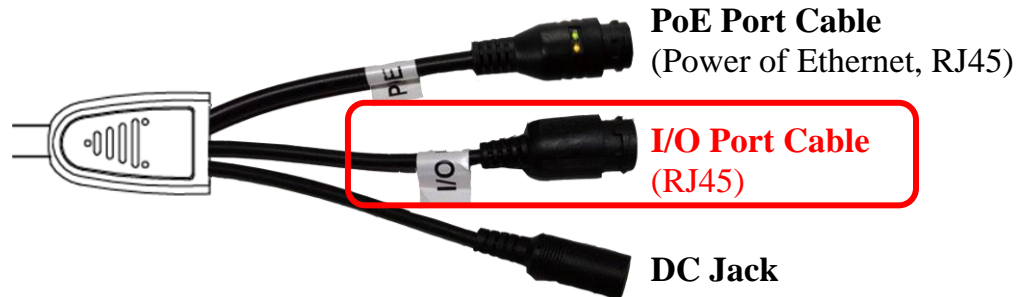

RJ45 Pin Table of I/O Port Cable:

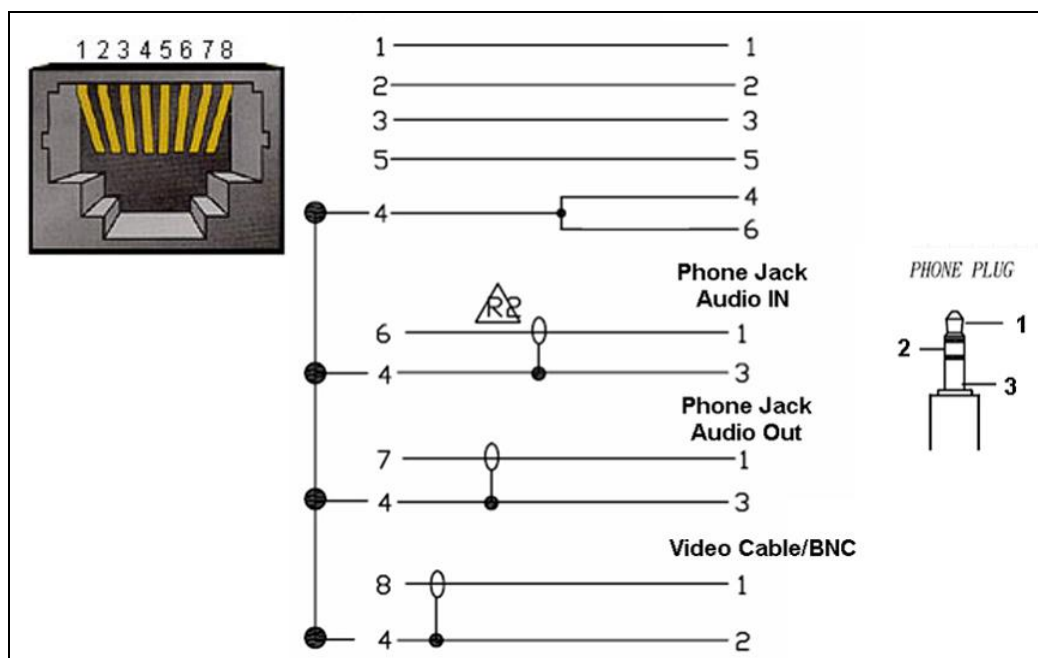

Pin	Function	Pin Descriptions of I/O Port Cable
1	DO_COM	<b>Digital Output:</b> each digital output pin to COM (Pin1) is a photo-coupled relay on Normal Open status. External device can directly connect to the terminals. However the current that will go through the 2 nodes must not exceed 130mA. An external “Relay” can also be connected to the terminals as an implementation. In this case, current (or/and voltage) limitation is specified by the external Relay.
2	DO_NO	
3	DI	<b>Digital Input:</b> Only one set is designed in this Camera Model. The internal device is also photo-coupled electrical relay; and the external device can be simply an On/Off switch. Each set of On/Off switch can be connected as one trigger source.
4	GND	
5	Default Setting	<b>Default Setting:</b> Short Pin4 and Pin5 with a wire PIN with a short wire to revert to factory default settings. Break the short when the LED starts quick flashing, and then camera will reboot automatically a few minutes later.
6	Audio In	
7	Audio Out	Don't forget to connect <b>Audio In / Audio Out / CVBS Out</b> GPIO Pin to GND for active; or leave floating (or unconnected) to deactivate.
8	CVBS Out	

- 3) While RJ45 Green LED Indicator of the **PoE Port Cable** is flashing quickly, means camera Hardware Reset Loading is processing now.....

***Please don't power off camera or do any unnecessary jobs during this 3 minutes interval time;*** camera would reboot and continue streaming automatically.