







-  x2
-  x24
-  x4
-  x12
-  x16
-  x12

1

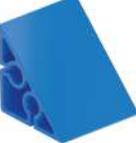
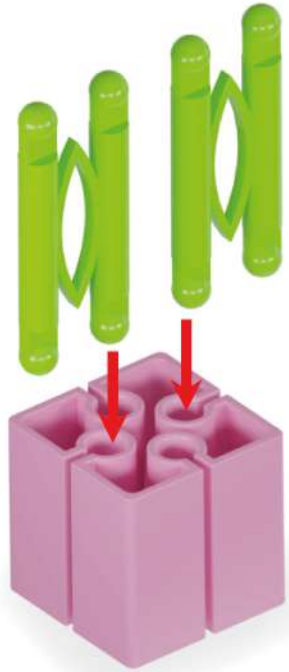

x6

x2      x4

x12



2

x6

 x24

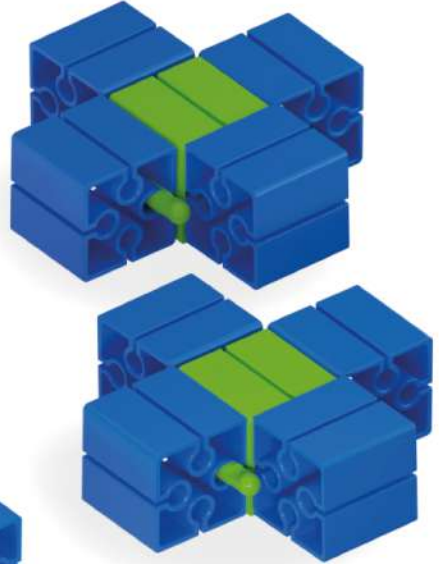
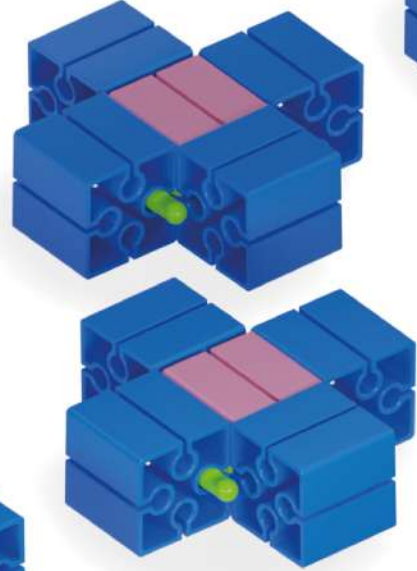
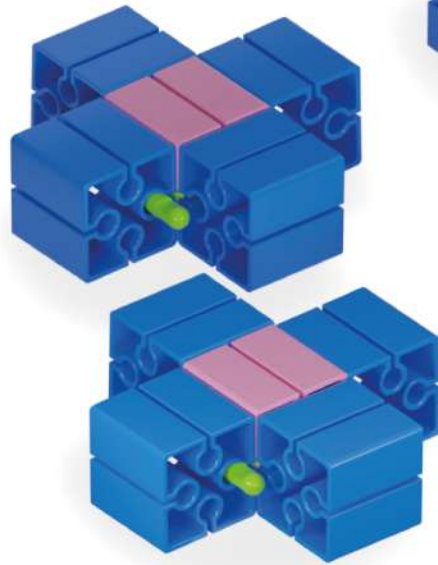
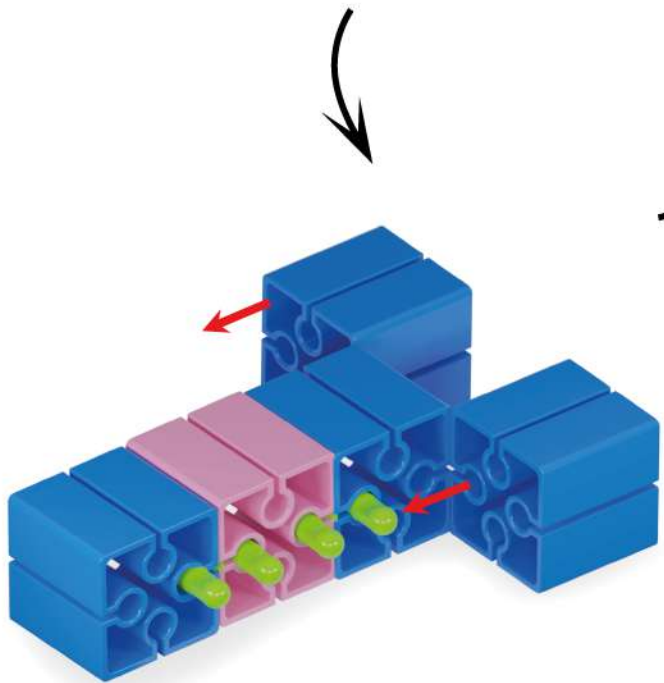
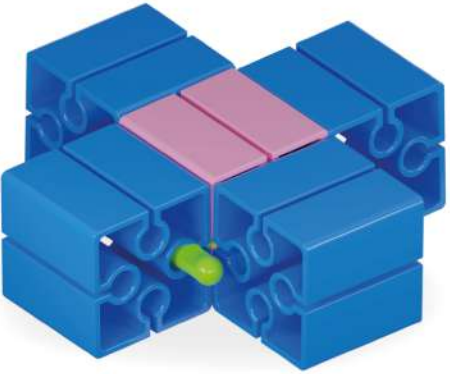
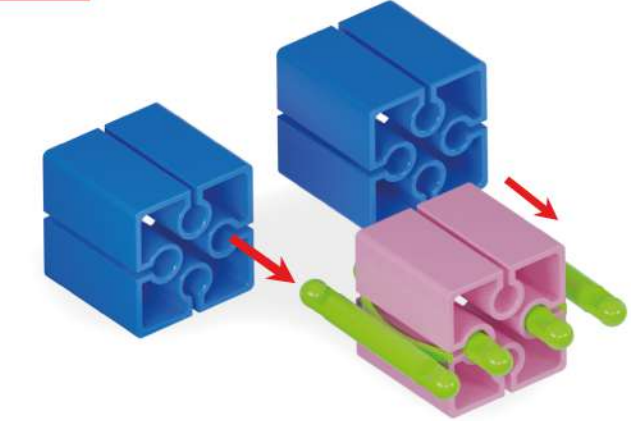

3

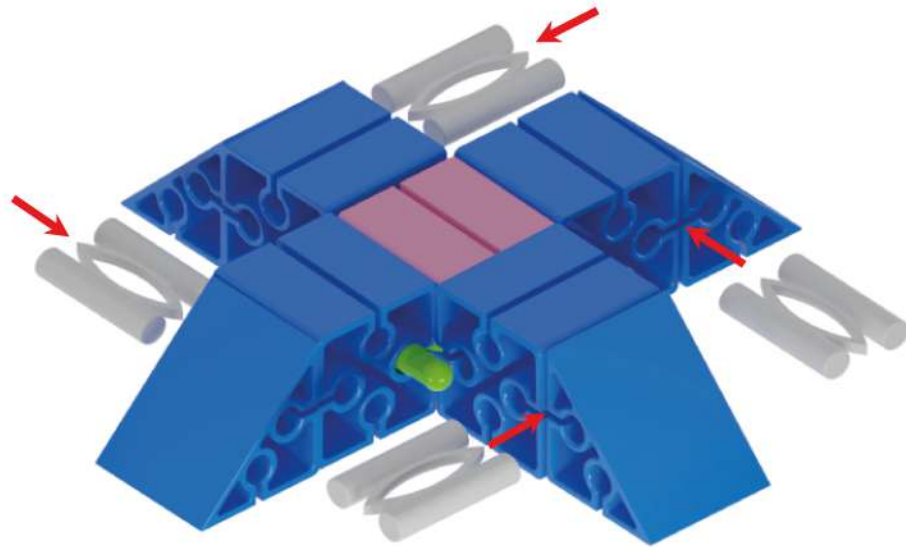

x2

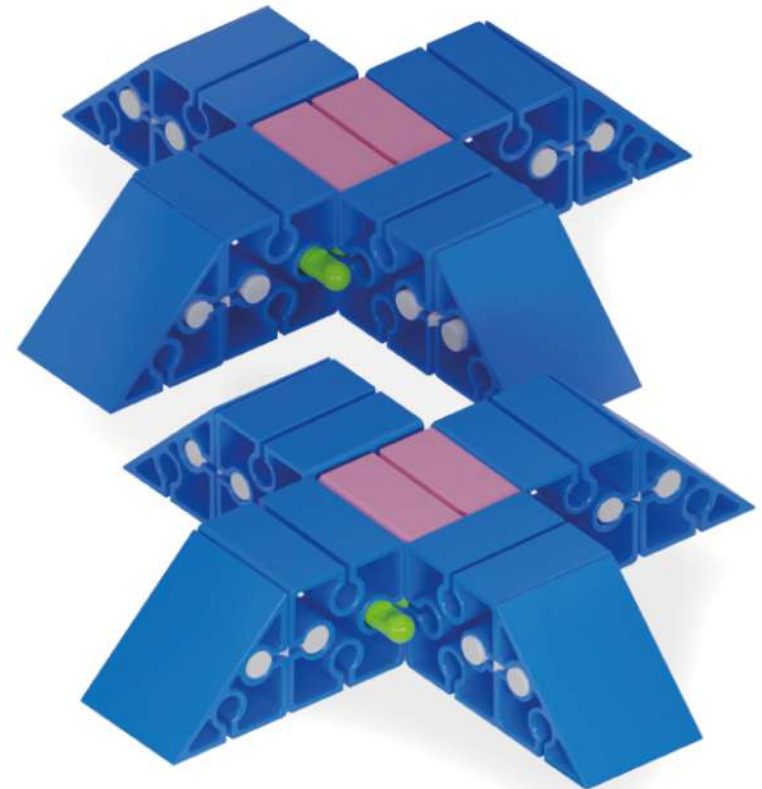
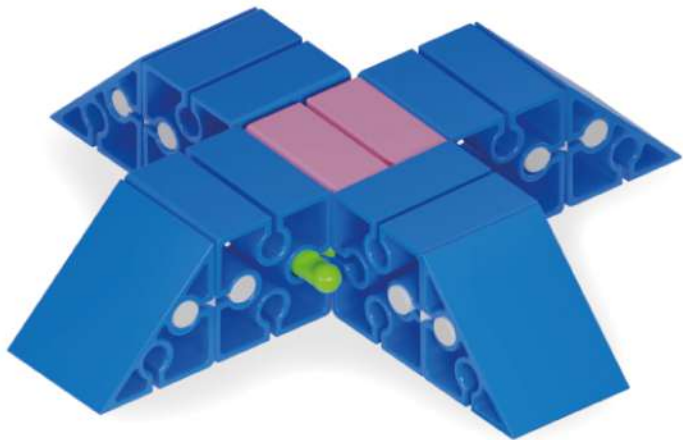





4

x2

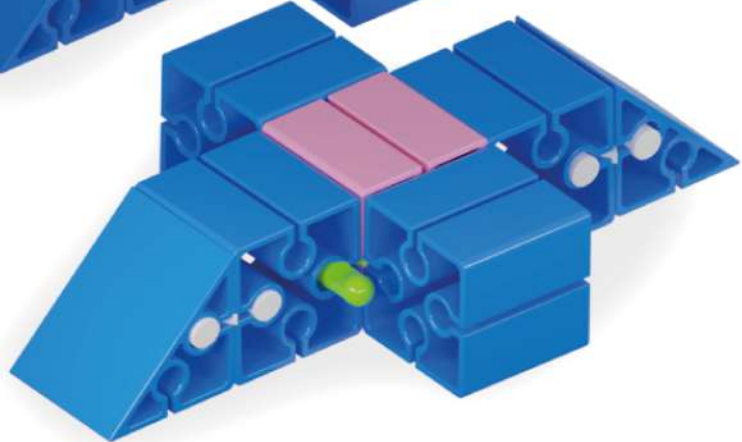
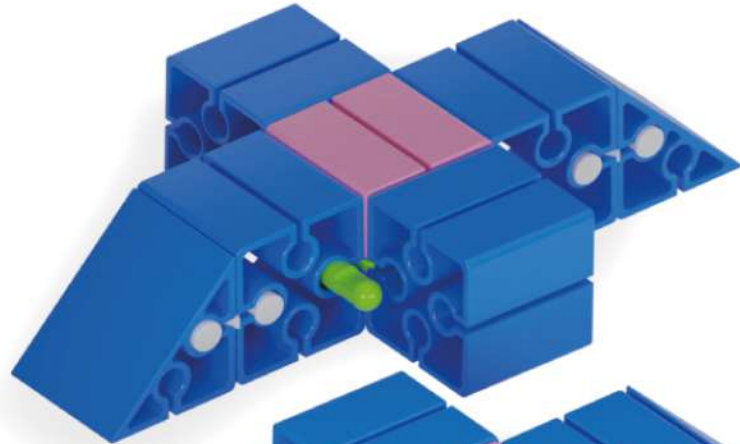
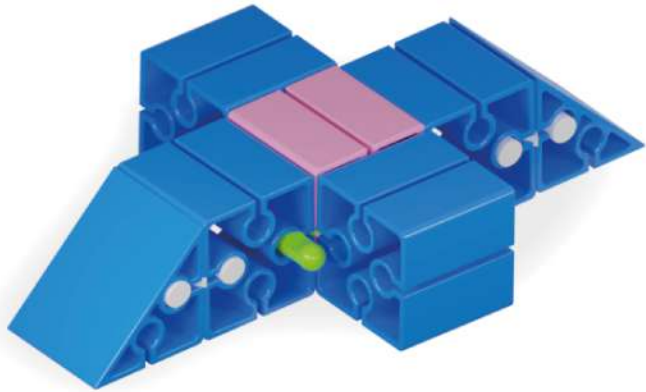
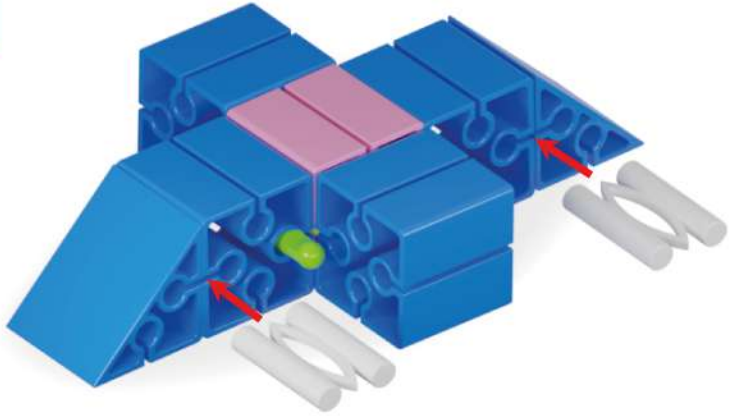
x4 x4



5

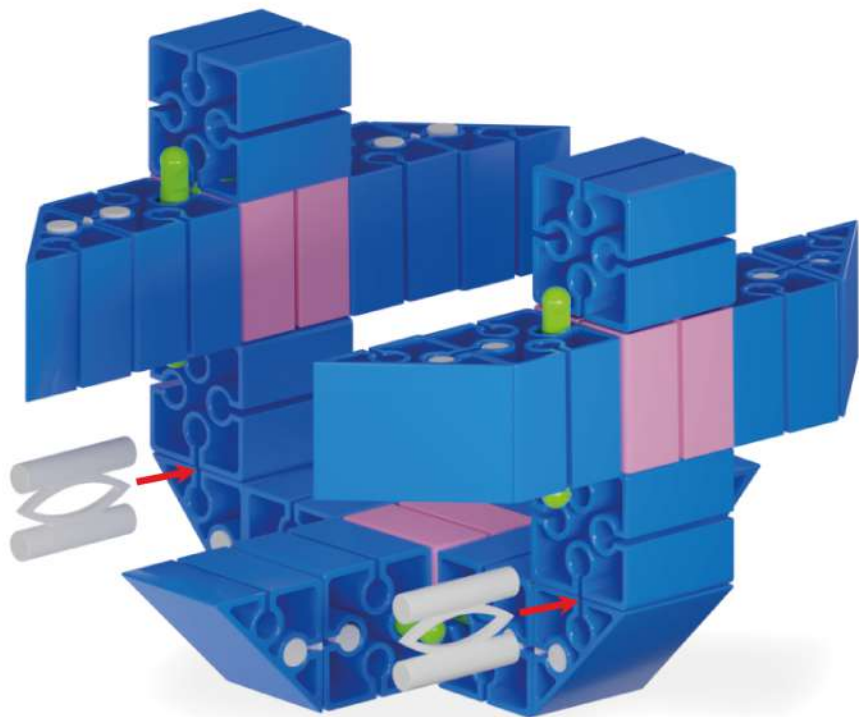

 x2

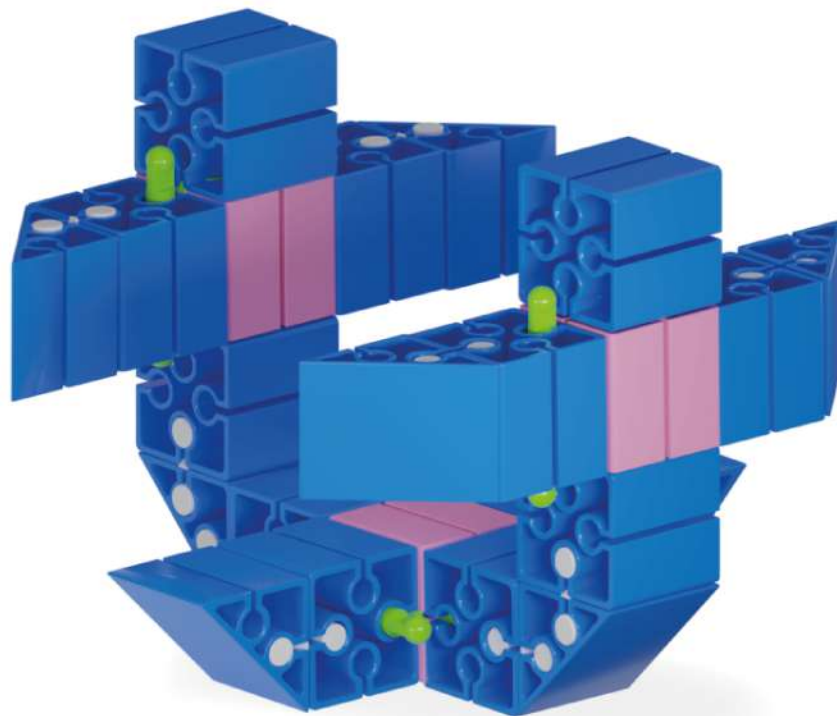

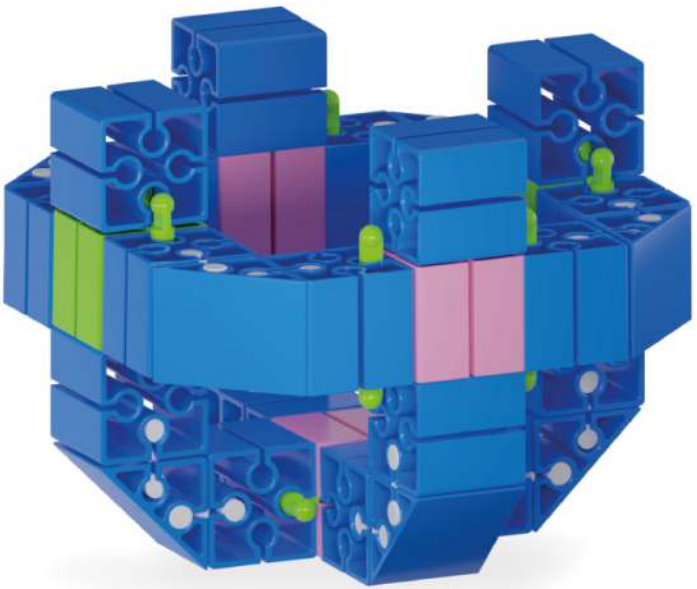
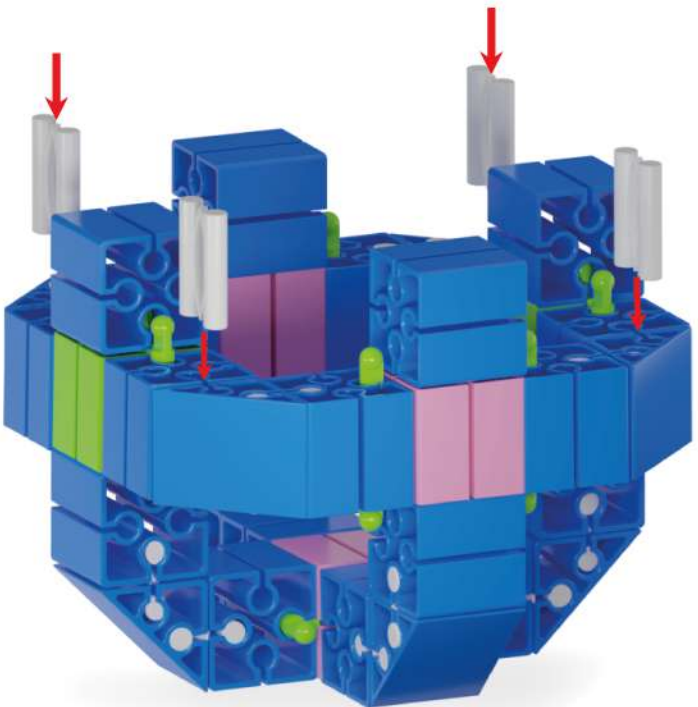
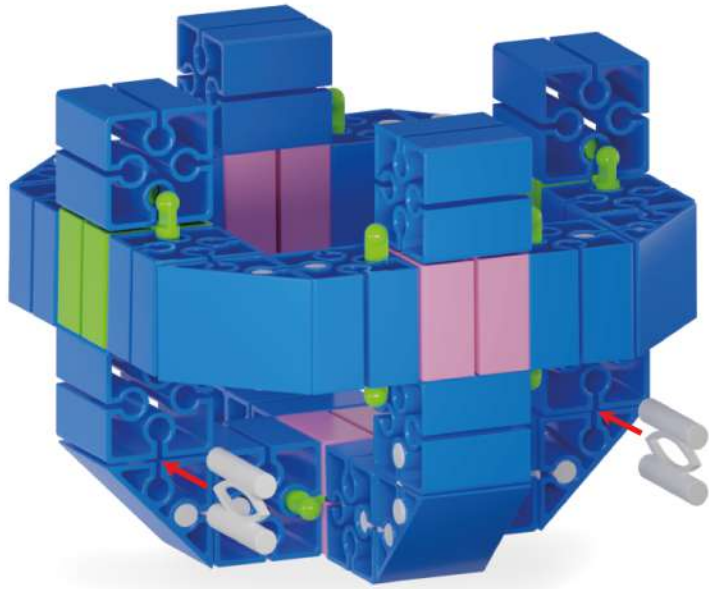

6

 x6

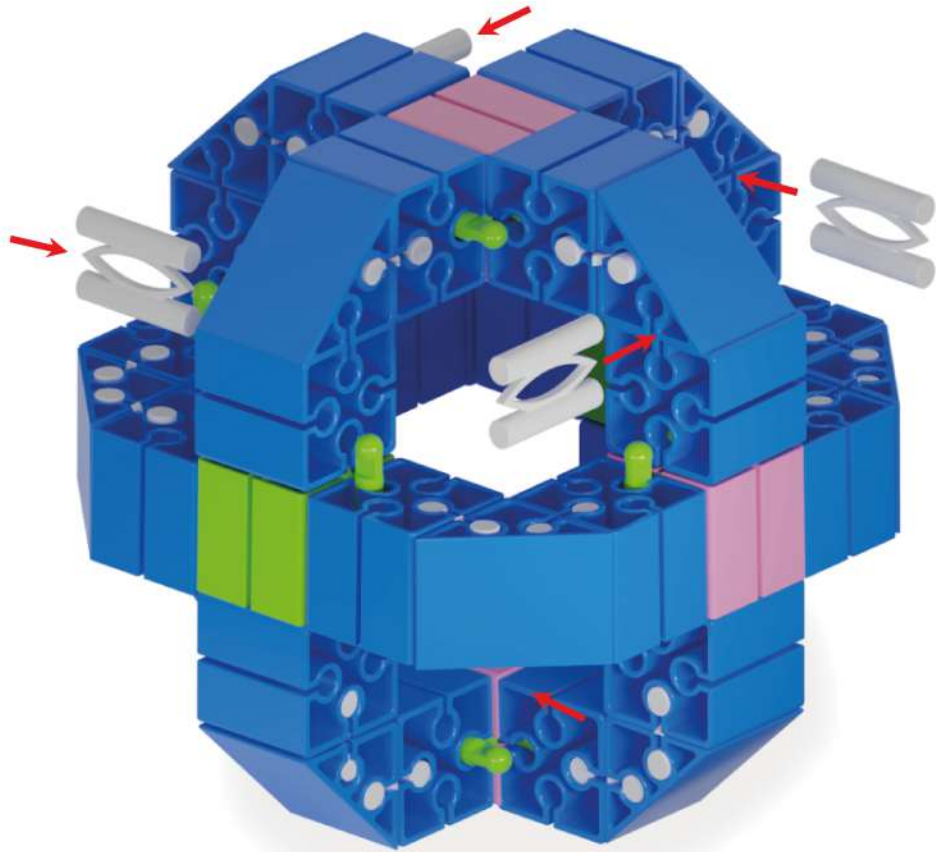

7



 x4

