

Major Ratings and Characteristics

Characteristics	Values	Units
$I_{F(AV)}$ Rectangular waveform	3.3	A
V_{RRM}	30/40	V
I_{FSM} @tp = 5 μ s sine	450	A
V_F @3 Apk, $T_J = 25^\circ\text{C}$	0.57	V
T_J	-40 to 150	$^\circ\text{C}$

Description/Features

The 31DQ.. axial leaded Schottky rectifier has been optimized for very low forward voltage drop, with moderate leakage. Typical applications are in switching power supplies, converters, free-wheeling diodes, and reverse battery protection.

- Low profile, axial leaded outline
- High purity, high temperature epoxy encapsulation for enhanced mechanical strength and moisture resistance
- Very low forward voltage drop
- High frequency operation
- Guard ring for enhanced ruggedness and long term reliability
- Lead-Free plating

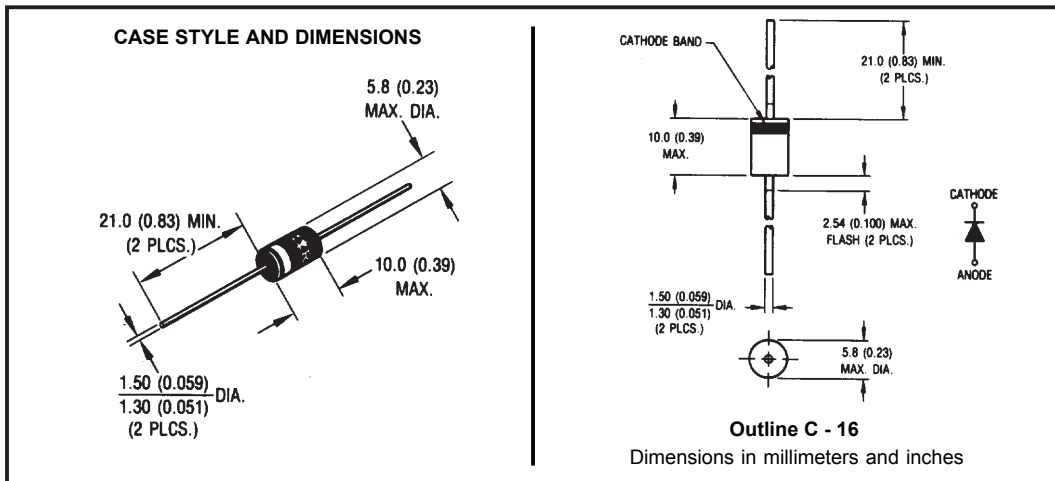

Voltage Ratings

Part number	31DQ03	31DQ04
V_R Max. DC Reverse Voltage (V)	30	40
V_{RWM} Max. Working Peak Reverse Voltage (V)		

Absolute Maximum Ratings

Parameters	31DQ..	Units	Conditions
$I_{F(AV)}$ Max. Average Forward Current * See Fig. 4	3.3	A	50% duty cycle @ $T_C = 73^\circ\text{C}$, rectangular wave form
I_{FSM} Max. Peak One Cycle Non-Repetitive Surge Current * See Fig. 6	450	A	5 μs Sine or 3 μs Rect. pulse
	90		10ms Sine or 6ms Rect. pulse
E_{AS} Non-Repetitive Avalanche Energy	6.0	mJ	$T_J = 25^\circ\text{C}$, $I_{AS} = 1.0$ Amps, $L = 12$ mH
I_{AR} Repetitive Avalanche Current	1.0	A	Current decaying linearly to zero in 1 μsec Frequency limited by T_J max. $V_A = 1.5 \times V_R$ typical

Electrical Specifications

Parameters	31DQ..	Units	Conditions
V_{FM} Max. Forward Voltage Drop * See Fig. 1 (1)	0.57	V	@ 3A
	0.71	V	@ 6A
	0.51	V	@ 3A
	0.62	V	@ 6A
I_{RM} Max. Reverse Leakage Current * See Fig. 2 (1)	1	mA	$T_J = 25^\circ\text{C}$
	20	mA	$T_J = 125^\circ\text{C}$
C_T Typical Junction Capacitance	190	pF	$V_R = 5V_{DC}$ (test signal range 100Khz to 1Mhz) 25°C
L_S Typical Series Inductance	9.0	nH	Measured lead to lead 5mm from package body
dv/dt Max. Voltage Rate of Change	10000	V/ μs	(Rated V_R)

(1) Pulse Width < 300 μs , Duty Cycle <2%

Thermal-Mechanical Specifications

Parameters	31DQ..	Units	Conditions
T_J Max. Junction Temperature Range (*)	-40 to 150	$^\circ\text{C}$	
T_{stg} Max. Storage Temperature Range	-40 to 150	$^\circ\text{C}$	
R_{thJA} Max. Thermal Resistance Junction to Ambient	80	$^\circ\text{C}/\text{W}$	DC operation Without cooling fins
R_{thJL} Typical Thermal Resistance Junction to Lead	34	$^\circ\text{C}/\text{W}$	With fin 20 x 20 (0.79 x 0.79) 1.0 (0.04) thick. Dimensions in millimeters (inches)
wt Approximate Weight	1.2 (0.042)	g (oz.)	
Case Style	C - 16		

(*) $\frac{dP_{tot}}{dT_J} < \frac{1}{R_{th(j-a)}}$ thermal runaway condition for a diode on its own heatsink

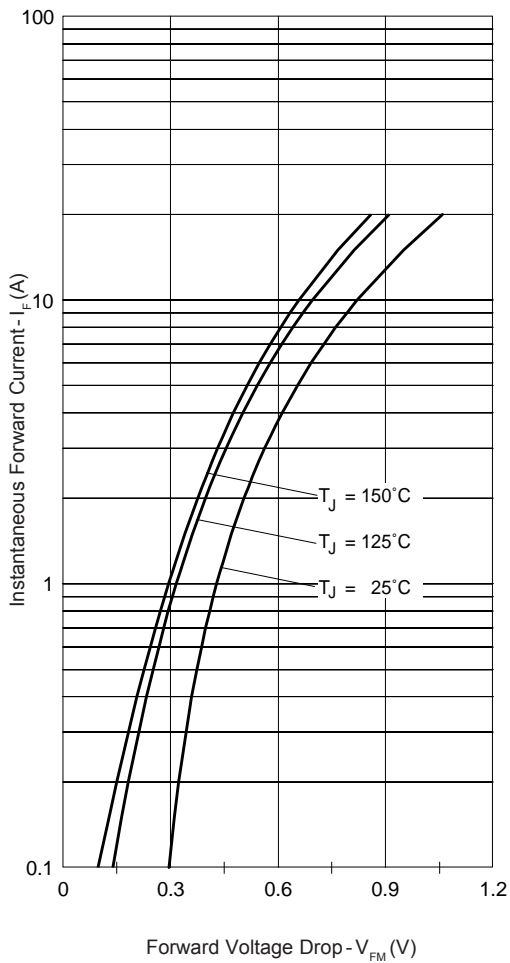

Fig. 1 - Max. Forward Voltage Drop Characteristics

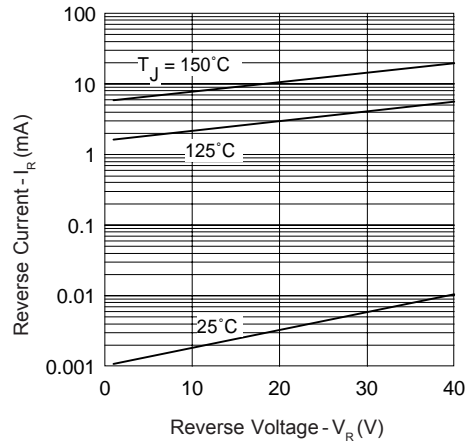

Fig. 2 - Typical Values Of Reverse Current Vs. Reverse Voltage

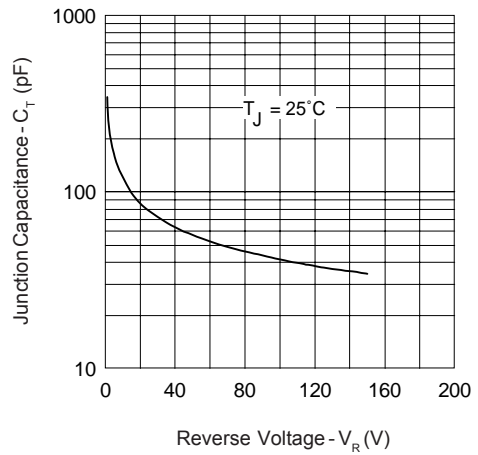

Fig. 3 - Typical Junction Capacitance Vs. Reverse Voltage

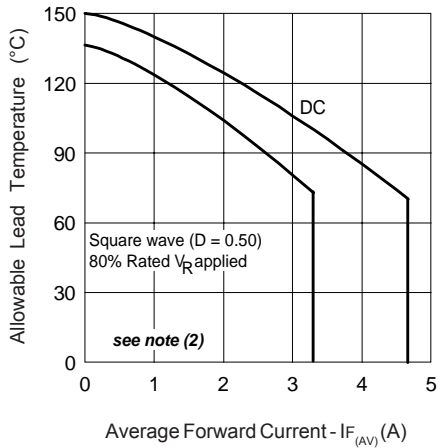

Fig. 4 - Max. Allowable Lead Temperature Vs. Average Forward Current

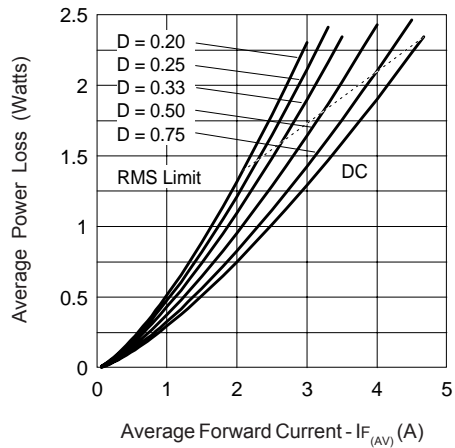

Fig. 5 - Forward Power Loss Characteristics

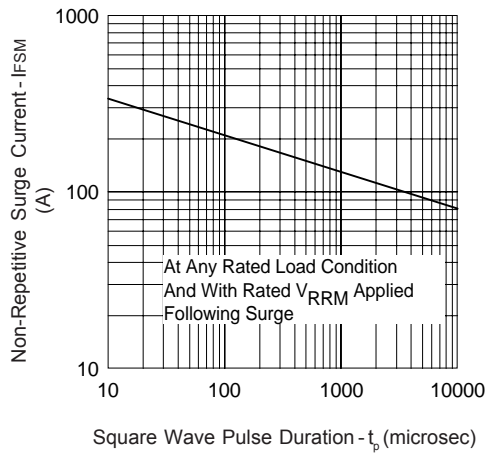

Fig. 6 - Max. Non-Repetitive Surge Current

(2) Formula used: $T_C = T_J - (Pd + Pd_{REV}) \times R_{thJC}$;

Pd = Forward Power Loss = $I_{F(AV)} \times V_{FM} @ (I_{F(AV)} / D)$ (see Fig. 6);

Pd_{REV} = Inverse Power Loss = $V_{R1} \times I_R (1 - D)$; $I_R @ V_{R1} = 80\%$ rated V_R

Ordering Information Table

Device Code											
	<table border="1" style="margin: auto;"> <tr> <td style="padding: 5px;">31</td> <td style="padding: 5px;">D</td> <td style="padding: 5px;">Q</td> <td style="padding: 5px;">04</td> <td style="padding: 5px;">TR</td> </tr> <tr> <td style="text-align: center;">①</td> <td style="text-align: center;">②</td> <td style="text-align: center;">③</td> <td style="text-align: center;">④</td> <td style="text-align: center;">⑤</td> </tr> </table>	31	D	Q	04	TR	①	②	③	④	⑤
31	D	Q	04	TR							
①	②	③	④	⑤							
1	- 31 = 3.1A (Axial and small packages - Current is x10)										
2	- D = DO-201 package										
3	- Q = Schottky Q.. Series										
4	- 04 = Voltage Ratings										
5	- TR= Tape & Reel package (1200 pcs) - = Box package (500 pcs)										

04 = 40V
 03 = 30V

Data and specifications subject to change without notice.
 This product has been designed and qualified for Industrial Level and Lead-Free.
 Qualification Standards can be found on IR's Web site.