

Table of Contents

1. Introduction	5
1.1 Features	6
1.2 Applications	6
2. Hardware	8
2.1 Specifications (GRP-530M)	8
2.2 Specifications (GRP-540M Serial)	9
2.3 Appearance and pin assignments	10
2.4 Dimensions	11
2.5 LED indicators	12
2.6 Rotary Switch	12
2.7 Installing Device	13
3. Web Utility	15
3.1 Login the Utility	15
3.2 Information	16
3.2.1 Device Information	16
3.2.2 Network Information	17
3.2.3 Storage Information	19
3.3 Network	20
3.3.1 Ethernet	20
3.3.2 WLAN (only support GRP-540M-4GX-WF)	20
3.3.3 PIN / APN Configure	22
3.3.4 Network Reconnection	23
3.3.5 DNS	23
3.3.6 DDNS Client	24
3.3.7 VPN (only support the firmware after v1.2.1)	25
3.3.8 Routing & Port Mapping (Port Forward)	26
3.3.9 Diagnostic	28
3.3.10 Reset Network	28
3.4 System	29
3.4.1 Password	29

3.4.2	Reboot.....	29
3.4.3	Reboot Timer	29
3.4.4	Backup & Restore.....	30
3.4.5	Update (only support the firmware after v1.2.1).....	30
3.4.6	Restore Factory	30
3.4.7	Time.....	31
3.5	VxServer	32
3.5.1	VxServer.....	32
3.6	RTU Client	34
3.6.1	RTU Client.....	34
3.6.2	FTP Test	38
3.6.3	Email Test.....	39
3.6.4	Modbus Test	40
3.7	RTU CAN Client.....	41
3.7.1	Basic Configure	41
3.7.2	CAN Configure	42
3.7.3	FTP/ Email.....	43
4.	Example	45
4.1	3G/4G Router Application	45
4.2	Web Server and IP Camera Application.....	48
4.3	Remote I/O Control / Temperature Monitor	52
4.4	Modbus/TCP to Modbus/RTU over 3G, and Card Reader Monitor.....	58
4.5	RTU Client for Remote Control Application with RTU API.....	63
4.6	RTU Client for Remote Control Application with OPC DA Server.....	75
4.7	RTU Client for Remote Control Application with InduSoft.	77
4.8	Email or FTP report I/O logger file.....	79
	Appendix A. Revision History	82

Important Information

Warranty

All products manufactured by ICP DAS are under warranty regarding defective materials for a period of one year, beginning from the date of delivery to the original purchaser.

Warning

ICP DAS assumes no liability for any damage resulting from the use of this product. ICP DAS reserves the right to change this manual at any time without notice. The information furnished by ICP DAS is believed to be accurate and reliable. However, no responsibility is assumed by ICP DAS for its use, not for any infringements of patents or other rights of third parties resulting from its use.

Copyright

Copyright © 2017 by ICP DAS Co., Ltd. All rights are reserved.

Trademark

Names are used for identification purpose only and may be registered trademarks of their respective companies.

Contact us

If you encounter any problems while operating this device, feel free to contact us via mail at: service@icpdas.com . We guarantee to respond within 2 working days.

1. Introduction

The GRP-530M / GRP-540M provided by ICP DAS is a 3G/4G gateway for Ethernet or serial port. With GPS function, it can also be a GPS tracking system. It can be used in M2M application fields to transfer the remote I/O, Modbus data or video of the camera via 3G/4G. Within the high performance CPU, the it can handle a large of data and are suit for the hard industrial environment. The GRP-530M / GRP-540M have 3G/4G module, Ethernet interface, CAN Bus, and GPS module.

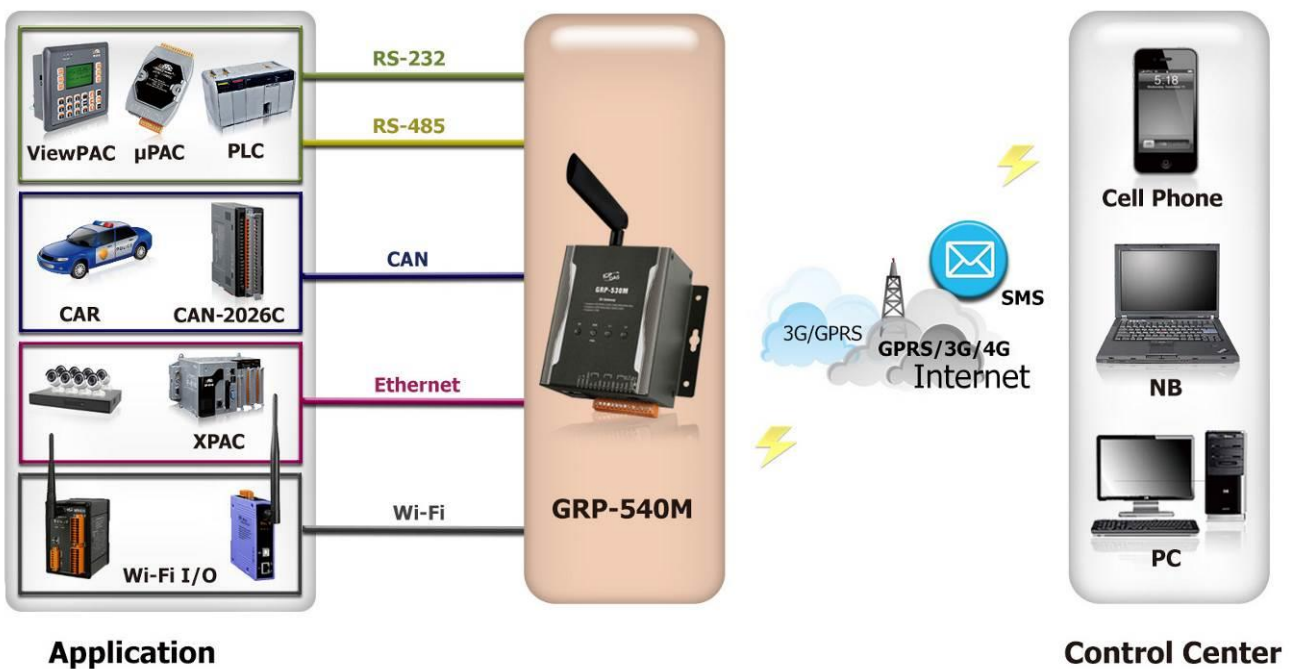

1.1 Features

- ◆ Support WCDMA 850/900/1900/2100 MHz and GSM 850 / 900 / 1800 / 1900 MHz. (GRP-530M)
- ◆ Support 4G/3G/2G (GRP-540M Serial)
- ◆ Support IEEE802.11b/g/n, 2.4 GHz (Only support GRP-540M-4GX-WF)
- ◆ 10/100 Base-TX compatible Ethernet controller
- ◆ COM port: COM1 (3-wire RS232), COM2 (3-wire RS232), COM3 (RS-485)
- ◆ Support CAN
- ◆ GPS : 32 channels with All-In-View tracking (option)
- ◆ Support Micro SD card.
- ◆ Provide 3G / 4G Router function.
- ◆ Support port mapping (port forward) function.
- ◆ Serial Port to 3G / 4G Gateway
- ◆ High reliability in harsh environments
- ◆ DIN-Rail mountable
- ◆ Support Dual SIM (GRP-541M only)

1.2 Applications

- ◆ 3G / 4G Router
- ◆ Home/Factory security
- ◆ Remote Video Monitor
- ◆ Energy Management
- ◆ Temperature Monitoring

Application 1: 3G/4G Router



Application 2: Remote Video Monitor



Application 3: Remote Control (Serial Port to 3G/4G gateway)



2. Hardware

2.1 Specifications (GRP-530M)

Item	GRP-530M
System / Software	
3G Gateway	Ethernet and Serial port (RS-232 x1, RS-485 x1) to 3G
Embedded service	Web Server, 3G Router
System	
CPU	ARM CPU
RAM	256 MB
Flash	256 MB
EEPROM	16 KB (Data Retention: 40 years; 1,000,000 erase/write cycles)
Expansion Flash Memory	SD Card (Max. 32GB SDHC)
RTC (Real Time Clock)	Provide seconds, minutes, hours, day of week/month, month and year
64-bit Hardware Serial Number	Yes
Watchdog Timer	Yes
LED Indicator	4 LEDs (RUN/PWR, 3G, L1, L2)
Rotary Switch	Yes (0~9)
GSM System	
Frequency Band	GSM: 850/900/1800/1900 MHz
GPRS connectivity	GPRS class 12; GPRS station class B
3G System	
Frequency Band	WCDMA 850/900/1900/2100 MHz
Data Transmission	WCDMA / HSPA+ Download: Max. 14.4Mbps; Upload: Max 5.76Mbps
GPS System	
Support Channels	32
Protocol Support	NMEA 0183
Comm. Interface	
Ethernet	RJ-45, 10/100/1000 Base-TX (Auto-negotiating, Auto MDI/MDI-X, LED indicators)
COM1	RS-232 (RxD, TxD and GND); Non-isolated (Console, Debug)
COM2	RS-232 (RxD, TxD and GND); Non-isolated
COM3	RS-485 (D2+, D2-); 3000 VDC isolated
CAN	CAN Bus (CAN_H, CAN_L)
Mechanism	
Casing	Matel
Dimensions(W x L x H)	117 mm x 126 mm x 58 mm (W x L x H)
Installation	DIN-Rail / Screw
Power	

Protection	Power reverse polarity protection
Frame Protection	Ground ESD, Surge, EFT, Hi-Pot
Required Voltage	Supply +10 V _{DC} ~ +48 V _{DC}
Power Consumption	4.8W (200 mA @ 24 V _{DC})
Environment	
Operation Temp.	-25°C to 75°C
Storage Temp.	-30°C to 80°C
Humidity	5~95% non-condensing

2.2 Specifications (GRP-540M Serial)

Item	GRP-540M-4GE GRP-541M-4GE	GRP-540M-4GE-WF	GRP-540M-4GC GRP-541M-4GC	GRP-540M-4GC-WF
Software				
Gateway Function	Ethernet and Serial port (RS-232 x1, RS-485 x1) to 3G/4G			
Embedded service	Web Server, Router function			
System				
CPU	ARM CPU			
EEPROM	16 KB (Data Retention: 40 years; 1,000,000 erase/write cycles)			
Expansion Flash Memory	SD Card (Max. 32GB SDHC)			
RTC (Real Time Clock)	Provide seconds, minutes, hours, day of week/month, month and year			
64-bit Hardware Serial Number	Yes			
Watchdog Timer	Yes			
LED Indicator	4 LEDs (RUN/PWR, 4G, L1, L2)			
Rotary Switch	Yes (0~9)			
GSM System				
Frequency Band	GSM: 850/900/1800/1900 MHz			
GPRS connectivity	GPRS class 12/10; GPRS station class B			
DATA GPRS	Downlink transfer: Max. 85.6 kbps; Uplink transfer: Max 42.8kbps			
3G System				
Frequency Band (MHz)	WCDMA 850/900/2100	WCDMA 900/2100 TD-SCDMA 1900/2100 CDMA2000 (BC0) 800		
Data Transmission	DC-HSPA+ Download: Max. 42 Mbps; Upload: Max 5.76Mbps TD-SCDMA Download: Max. 4.2 Mbps; Upload: Max 2.2Mbps CDMA2000 EVDO Download: Max. 14.7 Mbps; Upload: Max 5.4Mbps			
4G System				
Frequency Band	FDD LTE: B1/B3/B5/B7/B8/B20	FDD LTE: B1/B3/B8 TDD LTE: B38/B39/B40/B41		
Data Transmission	Download Max 100Mbps / Upload Max 50Mbps			
GPS System				
Support Channels	32			
Protocol Support	NMEA 0183			
Comm. Interface				

Ethernet	RJ-45, 10/100 Base-TX (Auto-negotiating, Auto MDI/MDI-X, LED indicators)			
Wi-Fi	N/A	IEEE802.11b/g/n, 2.4 GHz, channel 1-13 (2.412 GHz - 2.472)	N/A	IEEE802.11b/g/n, 2.4 GHz, channel 1-13 (2.412 GHz - 2.472)
COM1	RS-232 (RxD, TxD and GND); Non-isolated (Console, Debug)			
COM2	RS-232 (RxD, TxD and GND); Non-isolated			
COM3	RS-485 (D2+, D2-); 3000 VDC isolated			
CAN	CAN Bus (CAN_H, CAN_L)			
Mechanism				
Casing	Metal			
Dimensions(W x L x H)	117 mm x 126 mm x 58 mm (W x L x H)			
Installation	DIN-Rail / Screw			
Power				
Protection	Power reverse polarity protection			
Frame Ground Protection	ESD, Surge, EFT, Hi-Pot			
Required Supply Voltage	+10 V _{DC} ~ +48 V _{DC}			
Power Consumption	4.8W (200 mA @ 24 V _{DC})			
Environment				
Operation Temp.	-25°C to 75°C			
Storage Temp.	-30°C to 80°C			
Humidity	5~95% non-condensing			

2.3 Appearance and pin assignments

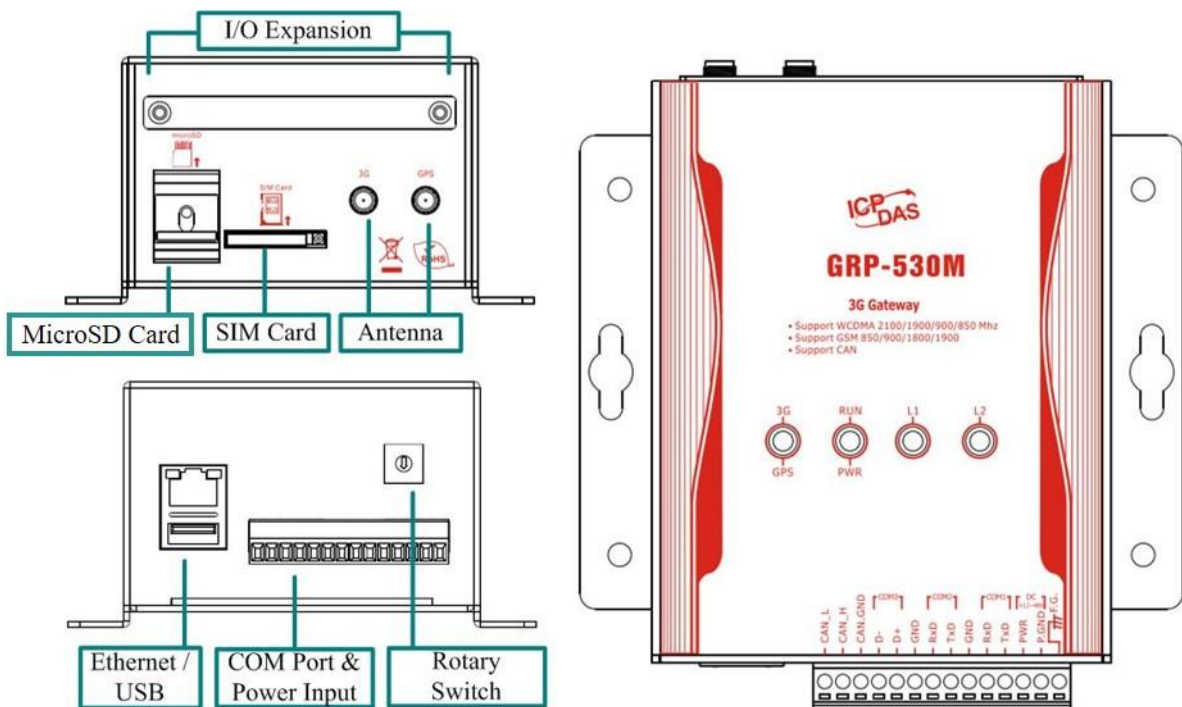

COM Port & Power Input		
Terminal No.		Pin Assignment
Power	14	F.G.
	13	P.GND
	12	PWR
COM1	11	TxD1
	10	RxD1
	09	GND
COM2	08	TxD2
	07	RxD2
	06	GND
COM3	05	D+
	04	D-
CAN	03	CAN.GND
	02	CAN_H
	01	CAN_L

2.4 Dimensions

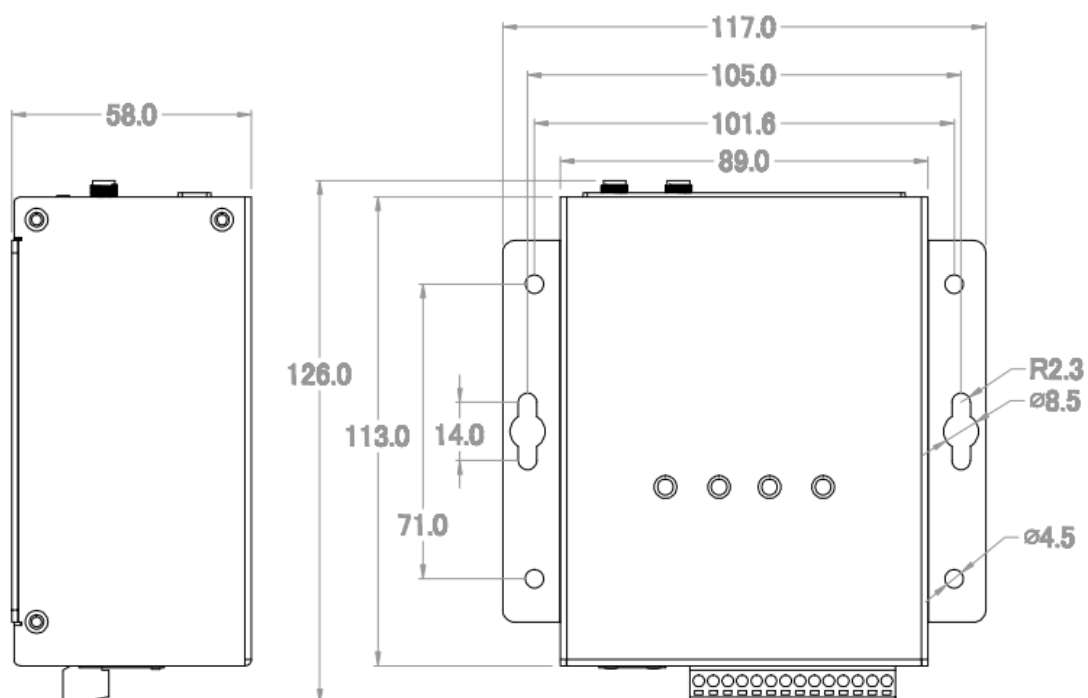

2.5 LED indicators

There are three LED indicators to help users to judge the various conditions of device. The description is as follows :

A.PWR(Green) : Power LED to indicate whether the external power is input or not. The description is as follows:

The external power is active	The external power is not active
on	off

B.RUN(Red) : RUN LED indicates if the OS is normal or fail.

Normal	Fail
Heart beat (1 sec.)	Always ON or OFF

C.L1(Green/Red) : this Led indicates the status of RTU Client.

Normal	Fail
500ms ON / 500ms OFF	Always ON or OFF

D.L2(Green/Red) : reserve.

E.3G (Red) : The LED indicates the status of 3G module.

(the 3G/4G module need about 60 seconds to register network usually)

Registered	3G/GPRS data transmit	Not Register
800ms ON / 200ms OFF	200ms ON, 200ms OFF	200ms ON / 800ms OFF

2.6 Rotary Switch

There are some functions of rotary switch. The description is as follows :

- A. 0 : Normal mode, default position:
- B. 9 : Factory default IP. If you set as 9, and then reset the device, its Ethernet IP will be "192.168.255.1". If you forgot your device IP, you can use this function to re-configure your device IP.

2.7 Installing Device

Before using, please follow these steps to install the device below:

- A. Install the antenna
- B. Plug in the normal SIM card (Before apply the SIM card, confirm it is OK by mobile phone.)
- C. Plug the Ethernet cable if you need it.
- D. If you want to use the Micro SD card, please insert it into the slot.
- E. Connect the DC.+VS and DC.GND to the power supply.
- F. It is needed to wait about 20 ~ 30 seconds for OS booting. After finishing the process, the device would be in normal operation mode and the OS LED would blank as heart beat per 1 sec.
- G. It is needed to wait about 30 ~ 60 seconds to search the 3G/4G base station and register to the ISP. After finishing the process, the 3G LED would blank per 1 sec.

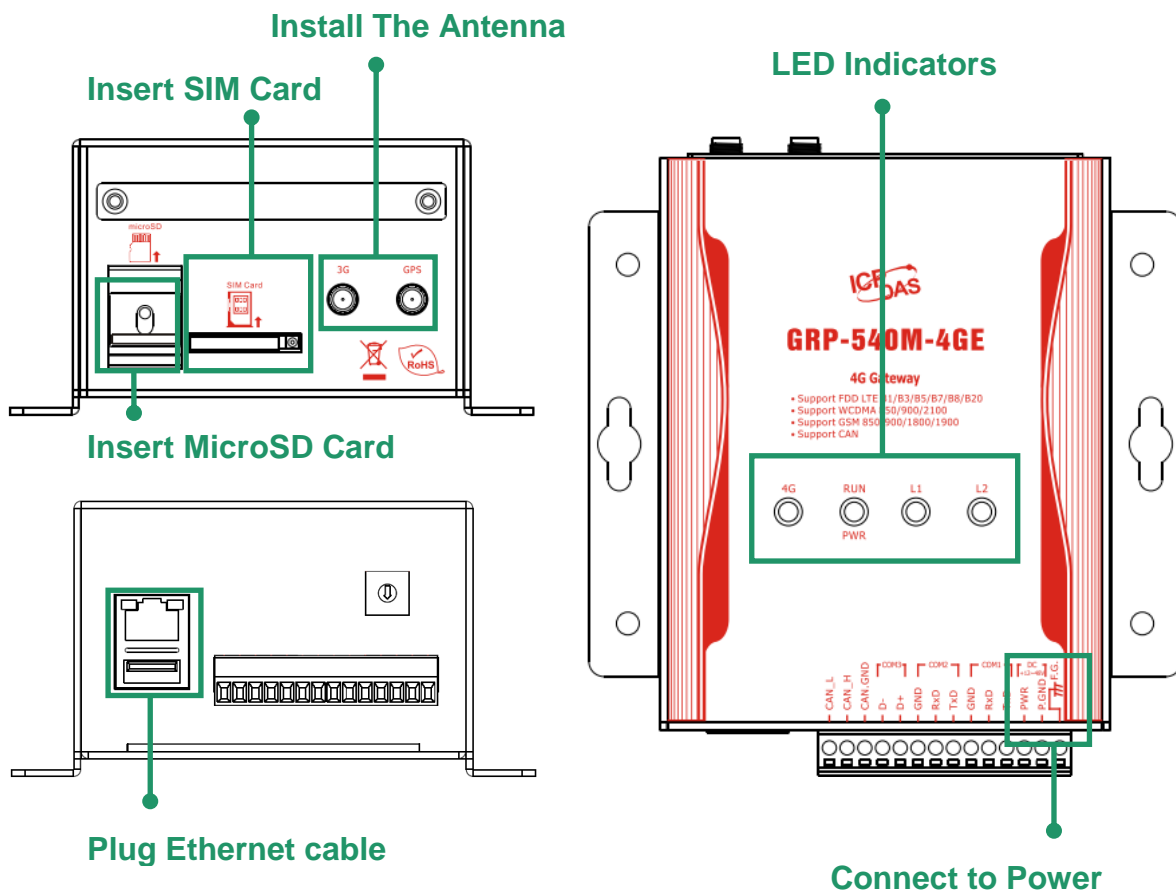

3. Web Utility

You must configure the device from web utility before using.

3.1 Login the Utility

Please login before you use the web utility. The default username is “admin”, and the default password is “admin”

Default IP = “192.168.255.1”

Default Mask = “255.255.0.0”

After login, the screenshot is showed as below:

Ethernet	
Mode	static
MAC address	68:c9:0b:7c:37:89
IP Address	192.168.255.1
Mask	255.255.0.0

WLAN information	
Mode	Closed

Mobile Network information	
Status	connected
IP Address	10.97.25.192
P-t-P	10.64.64.64

Modem information	
IMEI	861075022019632
PIN Code	+CPIN: READY
Register Status	Registered
Signal Quality	68%

GPS information	
GPS Status	GPS is ready, @(22.6202772833, 120.30106635) --> show map
GPS Data	\$GPRMC,012958.0,A,2237.216637,N,12018.063981,E,0.0,84.8,150917,.,,A*5A

3.2 Information

You can get the basic information of the device here.

3.2.1 Device Information

This page provides basic device information:

Device Information	
Serial Number	36B360810000
Kernel Version	3.2.14
Firmware Version	GRP-530M_V1.1.2_20161026

- (1) Product Name: the Name of your product
- (2) Serial Number: only one number of ICPDAS product
- (3) OS Kernel Version: linux kernel version.

3.2.2 Network Information

This page provides basic network information:

Ethernet	
Mode	static
MAC address	68:c9:0b:7c:37:89
IP Address	192.168.255.1
Mask	255.255.0.0

WLAN information	
Mode	Closed

Mobile Network information	
Status	connected
IP Address	10.97.25.192
P-t-P	10.64.64.64

Modem information	
IMEI	861075022019632
PIN Code	+CPIN: READY
Register Status	Registered
Signal Quality	68%

GPS information	
GPS Status	GPS is ready, @(22.6202772833, 120.30106635) --> show map
GPS Data	\$GPRMC,012958.0,A,2237.216637,N,12018.063981,E,0.0,84.8,150917,.,,A*5A

(1) Ethernet: Ethernet information

- Mode: static IP
- MAC address: a unique identifier assigned to network interfaces.
- IP Address: a computer's address under the Internet Protocol
- Mask: Mask will be provided from Gateway provider.

(2) WLAN information (only support GRP-540M-4GX-WF): AP Mode & Station Mode

AP Mode:

- Mode: AP
- SSID: the name shows up in Wi-Fi station
- MAC address: a unique identifier assigned to network interfaces
- IP Address: the IP address which is set by user
- Mask: the Mask which is set by user
- Security: the mode of AP's security. Please refer to below:
 - No security: any Wi-Fi stations can access this AP without password
 - WPA2-PSK: use WPA2-PSK security mode, Wi-Fi stations use password to access
- Password: only show out with WPA2-PSK security mode

Station Mode:

- Mode: Station
- Connected SSID: the AP which is connected by this station
- MAC address: a unique identifier assigned to network interfaces
- IP Configure: use which method to get IP address. Please refer to below:
 - Static: user can set IP address, Mask, and Gateway by himself
 - DHCP: get IP address, Mask, and Gateway from AP's DHCP server
- IP Address: the station's address under the Internet Protocol
- Mask: Mask will be provided from AP provider
- Status: the connection status. Please refer to below:
 - Connected: this station already connected to remote AP successfully
 - Connecting: this station is trying to connect with remote AP
- Signal Level (dbm): close to 0 dbm is better, but 0 dbm means still try to connect

(3) Mobile Network information: the information will show out after dial up

- Status: "connected" mean the modem dial-up success.
- IP Address: the IP is provide by ISP provider.
- P-t-P: provide by ISP provider.
- IP Address for VPN: the IP is provide by VPN Server.
- P-t-P for VPN: provide by VPN Server.

(4) Modem information:

- SIM Select: The SIM which has been used now. (Only show up in GRP-541M)
- IMEI: IMEI number of 4G module.

- PIN Code: the status of PIN Code. Please refer to below:
 READY: PIN Code is ready.
 SIM PIN: need PIN code of SIM card
 SIM PUK: need PUK code of SIM card
 SIM failure: Access SIM Card failure
- Register Status: Indicating machine connect to mobile network successful or not.
- Signal Quality: the 3G/4G signal quality.

3.2.3 Storage Information

This page provides information about “Micro SD card”, “USB Disk”:

USB Disk	
Size	3936220 KB
used	2584 KB
Available	3933636 KB
Path (Mount Point)	/media/usbhd-sda1

Micro SD Card	
Size	31154688 KB
used	25344 KB
Available	31129344 KB
Path (Mount Point)	/media/mmcblk0p1

(1) USB Disk / SD card:

- Size: total size of storage
- used: the size is used
- Available: free space in the storage
- Path: the mount point in file system.

3.3 Network

The user can configure the Network functions here.

3.3.1 Ethernet

This page provides the basic settings of Ethernet:

Ethernet	
IP Address	<input type="text" value="192.168.27.31"/>
Mask	<input type="text" value="255.255.0.0"/>
Gateway	<input type="text" value="192.168.0.254"/>
<input type="button" value="Modify"/>	

- (1) IP Address: IP of Ethernet.
- (2) Mask: the Mask of the gateway.
- (3) Gateway: IP of the gateway.

3.3.2 WLAN (only support GRP-540M-4GX-WF)

This page provides the basic settings of Wi-Fi ap mode or station mode:

AP Mode:

AP Mode	Station Mode
IP Address	<input type="text" value="10.10.0.1"/>
Mask	<input type="text" value="255.255.255.0"/>
Network	<input type="text" value="10.10.0.0"/>
SSID	<input type="text" value="icpdas-ap"/>
Channel	<input type="text" value="6"/> (Channel 1~14)
Security	<input type="text" value="WPA2-PSK ▼"/>
Password	<input type="text" value="1234567890"/> (8~64 characters)
Enable Function	<input checked="" type="checkbox"/> Enable
<input type="button" value="Modify"/>	
<p>(1):The Wi-Fi will reboot immediately. (2):Remember to check routing rule. (2):Make sure Wi-Fi device can search the channel.</p>	

- (1) IP Address: IP of this Wi-Fi AP.
- (2) Mask: the Mask of this Wi-Fi AP.
- (3) Network: the Network of this Wi-Fi AP.
- (4) SSID: the name of this Wi-Fi AP.
- (5) Channel: the channel of this Wi-Fi AP.
- (6) Security: set no security or WPA2-PSK security mode.
- (7) Password: if use WPA2-PSK, need to set password for 8~64 characters.

Station Mode:

AP Mode	Station Mode
AP's SSID	None
AP's Password	None
IP Configure	Static ▼
IP Address	
Mask	
Gateway	
Enable Funcion	<input type="checkbox"/> Enable
<input type="button" value="Modify"/>	
(1):Need to wait for connection. (2):Remember to check routing rule.	

- (1) AP's SSID: the name of remote Wi-Fi AP.
- (2) AP's Password: the password of remote Wi-Fi AP.
- (3) IP Configure: use Static or DHCP method to get IP address
- (4) IP Address: if use Static mode, set IP of this Wi-Fi station.
- (5) Mask: if use Static mode, set Mask of this Wi-Fi station.
- (6) Gateway: if use Static mode, set Gateway of this Wi-Fi station. (if already have default gateway for 3G/4G, the default gateway for Wi-Fi station will be deleted)

3.3.3 PIN / APN Configure

This page provides basic settings of 3G/4G network:

GRP-530M/GRP-540M:

PIN / APN Configure	
PIN Code	0000
Phone Number	*99***1# (1)
APN	internet (2)
User Name	(2)
Password	(2)
<input type="button" value="Modify"/>	
(1):usually use *99# or *99***1# (2):please ask your SIM Card provider	

GRP-541M:

PIN / APN Configure	
SIM 1	
PIN Code	0000
Phone Number	*99***1# (1)
APN	internet (2)
User Name	(2)
Password	(2)
SIM 2	
PIN Code	0000
Phone Number	*99***1# (1)
APN	internet (2)
User Name	(2)
Password	(2)
Enable Dual SIM	<input type="checkbox"/> Enable
<input type="button" value="Modify"/>	
(1):usually use *99# or *99***1# (2):please ask your SIM Card provider	

- (1) PIN Code: PIN Code are 4 character number provided by SIM Card provider
- (2) Phone Number: usually fill it as “*99***1#” or “*99#”. It depends on SIM Card provider

- (3) APN: Access Point Name, please ask your SIM Card provider.
- (4) User Name: the username for dial-up. Please ask your SIM Card provider.
- (5) Password: the password for dial-up. Please ask your SIM Card provider.
- (6) Enable Dual SIM: Default is using SIM1. If enable this function, the SIM card will be auto changed to another when the network is reconnecting. (Only show up in GRP-541M)

3.3.4 Network Reconnection

This function can keep the device always on mobile network, but it will send the IMCP signals to check mobile network.

The default setting is “Enable” to keep device always online.

Network Reconnection	
Server IP	<input type="text" value="8.8.8.8"/>
Max. Retry	<input type="text" value="5"/>
Retry Interval Time	<input type="text" value="30"/>
Enable Funcion	<input checked="" type="checkbox"/> Enable
<input type="button" value="Modify"/>	
(1):This function will run immediatly after you press "Modify" button (2):GSM module will be reset after Max. retry (3):System will reboot after GSM module reset 100 times	

- (1) Server IP: the target IP or URL that you want to send signal (ping the target IP).
- (2) Max. Retry: if the system retry time is over this number, it will reset 3G/4G modem and dial-up to try again.
- (3) Interval Time: the interval time between this retry and last.
- (4) Enable Function: if you enable this function, it will run immediately.

3.3.5 DNS

The user can set DNS server IP here:

DNS Server	
Primary DNS Server	<input type="text" value="168.95.1.1"/>
Alternate DNS Server	<input type="text" value="8.8.8.8"/>
<input type="button" value="Modify"/>	

- (1) Primary DNS Server: the device will use it to get DNS service first.
- (2) Alternate DNS Server: if “Primary DNS Server” is invalid, the device will use “Alternate DNS Server”.

3.3.6 DDNS Client

DDNS is a method of updating, in real time, a Domain Name System (DNS) to point to a changing IP address on the Internet:

DDNS Configure	
Server	default@no-ip.com <input type="button" value="v"/>
Domain	yourDomain.no-ip.org
Username	yourUserName
Password	yourPassword
Period	60 seconds
Enable	<input checked="" type="checkbox"/> Enable
<input type="button" value="Modify"/>	

- (1) Server: the address of DDNS service provider.
- (2) Domain: The domains name you registered.
- (3) Username: the username of DDNS service.
- (4) Password: the password of DDNS service.
- (5) Period: the period time (seconds) to update your address.
- (6) Enable: Enable DDNS function.

3.3.7 VPN (only support the firmware after v1.2.1)

User can set VPN with **PPTP protocol** and use DDNS or FTP to get the VPN IP:

VPN Configure	
VPN Server	<input type="text" value="vpnServerIP"/>
VPN Username	<input type="text" value="yourUserName"/>
VPN Password	<input type="text" value="yourPassword"/>
DDNS	<input type="text" value="Enable"/>
DDNS Server	<input type="text" value="dynupdate.no-ip.com"/>
DDNS Domain Name	<input type="text" value="yourDomain.no-ip.org"/>
DDNS Username	<input type="text" value="yourUserName"/>
DDNS Password	<input type="text" value="yourPassword"/>
DDNS Period	<input type="text" value="60"/>
FTP	<input type="text" value="Enable"/>
FTP Server	<input type="text" value="ftpServerIP"/>
FTP Port	<input type="text" value="ftpServerPort"/>
FTP Username	<input type="text" value="yourUserName"/>
FTP Password	<input type="text" value="yourPassword"/>
FTP File Name	<input type="text" value="vpn_ip.txt"/>
FTP Period	<input type="text" value="60"/>
FTP Passive Mode	<input type="checkbox"/> Enable
VPN Enable	<input type="checkbox"/> Enable
<input type="button" value="Modify"/>	
(1):The VPN of GRP uses PPTP protocol. (2):The DDNS and FTP in this page is used to let user get the VPN IP.	

- (1) VPN Server: the address of VPN service provider.
- (2) VPN Username: the username of VPN service.
- (3) VPN Password: the password of VPN service.

DDNS:

- (1) DDNS Server: the address of DDNS service provider.
- (2) DDNS Domain Name: The domains name you registered.
- (3) DDNS Username: the username of DDNS service.

- (4) DDNS Password: the password of DDNS service.
- (5) DDNS Period: the period time (seconds) to update your address.

FTP:

- (1) FTP Server: the address of FTP service provider.
- (2) FTP Port: the port of FTP service provider.
- (3) FTP Username: the username of FTP service.
- (4) FTP Password: the password of FTP service.
- (5) FTP File Name: the file in the server to save your address.
- (6) FTP Period: the period time (seconds) to update your address.
- (7) FTP Passive Mode: enable the passive mode.

3.3.8 Routing & Port Mapping (Port Forward)

This page provides routing rule & Port Forward configuration.

ROUTING Rule			
Rule NO.	IP	Mask	Target
0	<input type="text" value="192.168.27.1"/>	24 <input type="button" value="v"/>	ppp0 <input type="button" value="v"/>
1	<input type="text"/>	<input type="button" value="v"/>	<input type="button" value="v"/>
2	<input type="text"/>	<input type="button" value="v"/>	<input type="button" value="v"/>
3	<input type="text"/>	<input type="button" value="v"/>	<input type="button" value="v"/>
4	<input type="text"/>	<input type="button" value="v"/>	<input type="button" value="v"/>
5	<input type="text"/>	<input type="button" value="v"/>	<input type="button" value="v"/>
6	<input type="text"/>	<input type="button" value="v"/>	<input type="button" value="v"/>
7	<input type="text"/>	<input type="button" value="v"/>	<input type="button" value="v"/>
8	<input type="text"/>	<input type="button" value="v"/>	<input type="button" value="v"/>
9	<input type="text"/>	<input type="button" value="v"/>	<input type="button" value="v"/>

• **Routing Rule**

- (1) IP: IP address.
- (2) Mask: the mask will effect how many IP this rule manages.
 "24" = 255 IPs, "28" = 16 IPs, "32" = 1 IPs.
- (3) Target: the target interface of the rule.

For example:

The Rule 0: This rule will push the socket packages from the address 192.168.27.1 ~ 192.168.27.255 forward to "ppp0" (3G network).

Port Mapping Rule					
Rule NO.	Type	From	Port	Target IP	Target Port
0	TCP ▾	ppp0 ▾	10080	192.168.27.140	80
1	▾	▾			
2	▾	▾			
3	▾	▾			
4	▾	▾			
5	▾	▾			
6	▾	▾			
7	▾	▾			
8	▾	▾			
9	▾	▾			

• **Routing Rule**

- (1) Type: the protocol type. There are “TCP” and “UDP”
- (2) From: the interface that the socket comes from.
"ppp0" is 3G interface.
- (3) Port: the port that the socket comes from.
- (4) Target IP: the IP that the socket goes forward.
- (5) Target Port: the Port of the “Target IP”.

For example:

The Rule 0: This rule will bind the socket from the “ppp0” and Port=“10080” with 192.168.27.140:80.

3.3.9 Diagnostic

This page provides the tools to check the problem of the network.

Ping Test	
Target IP	<input type="text" value="8.8.8.8"/>
Result	<input type="text"/>
<input type="button" value="ping"/>	

Traceroute	
Target IP	<input type="text" value="8.8.8.8"/>
Result	<input type="text"/>
<input type="button" value="traceroute"/>	
This function will take time more than 2 minute.	

Route Information	
Result	<input type="text"/>
<input type="button" value="route"/>	

- (1) Ping Test: this tool will ping "Target IP", and show result below.
- (2) Traceroute: this tool will trace routing path to "Target IP", and show the result below.
- (3) Route Information:: this tool will show route setting below.

3.3.10 Reset Network

If user forgets how to set routing, this page provides to reset all of Ethernet, WLAN, DHCP Server, and ROUTING Rule configure.

Notice!!	
Are you sure to reset network? It will reset your Ethernet, WLAN, DHCP Server, and ROUTING Rule configure. Please wait a minute for system rebooting after you press reset button.	
<input type="button" value="Reset"/>	
(1):The default Ethernet IP is 192.168.255.1 (2):The default WLAN IP is 10.10.0.1	

3.4 System

The user can configure “password”, “system parameter”, reboot the device and restore factory settings here.

3.4.1 Password

The user can change the password of the web utility here.

Change Password	
New Password	<input type="text"/>
Confirm	<input type="text"/>
<input type="button" value="Modify"/>	
The length of password must be more then 4 characters that limited in a~z, A~Z, 0~9.	

- (1) Password: new password.
- (2) Confirm: confirm the password again.

3.4.2 Reboot

The user can reboot the device here.

Notice!!
Are you sure to reboot? please wait a minute for system rebooting after you press reboot button.
<input type="button" value="Reboot"/>

3.4.3 Reboot Timer

The user can use this function to reboot system automatically.

Reboot Timer (Reboot system automatically)	
Reboot Time (everyday)	<input type="text" value="0"/> : <input type="text" value="0"/> (hour:minute)
Enable Funcion	<input type="checkbox"/> Enable
<input type="button" value="Modify"/>	
(1): This function will run immediately after you press "Modify" button	

- (1) Reboot Time (everyday): the time for rebooting system.
- (2) Enable: Enable Reboot Timer function.

3.4.4 Backup & Restore

The user can backup the device settings and restore it here.

Backup & Restore	
Backup	<input type="button" value="Backup"/>
Restore	<input type="text" value=""/> <input type="button" value="瀏覽..."/> <input type="button" value="Restore"/>

- (1) Backup: Press "Backup" button to backup settings into your PC.
- (2) Restore: Press "Browse" button to select file, and then press "Restore" button to store your settings.

3.4.5 Update (only support the firmware after v1.2.1)

The user can update the device's firmware by themselves. Need to go to the product page and download the update file (updateFile.tar). Must put the update file into SD card and backup your config before update.

Update
Are you sure to update? It may reset some configure file.
<input type="button" value="Update"/>
(1):Must put "updateFile.tar" file in SD card. (2):Need to wait several minutes for update. (3):It will reboot after update.

3.4.6 Restore Factory

The user can restore the device setting to factory default.

Restore Factory Setting
The device will reboot after restoring factory settings.
<input type="button" value="Restore"/>

3.4.7 Time

This page provide information about the time of the device.:

Time Configure	
Device Time (24-hour)	2015 / 11 / 06 10 : 23 : 38 <input type="button" value="Set Time"/>
NTP Server (Time Server)	<input type="text" value="tock.stdtime.gov.tw"/> Ex: tock.stdtime.gov.tw
Timezone	+8 <input type="button" value="check timezone"/>
Enable NTP Funcion	<input checked="" type="checkbox"/> Enable
<input type="button" value="Modify"/>	

- (1) Set Time: set the time of device the same as your computer.
- (2) NTP Server: device will connect to the NTP Server to synchronize time.
- (3) Timezone: if you do not know your timezone, please click the link "check timezone" to find out.
- (4) Enable NTP Function: if you enable it, the device will update time automatically.

3.5 VxServer

The user can configure VxServer firmware here.

3.5.1 VxServer

The user can configure VxServer firmware here.

Virtual COM Function (VxServer)	
Server IP	<input type="text" value="192.168.12.2"/>
Server Port	<input type="text" value="11000"/> default=11000
Heartbeat Time	<input type="text" value="10"/> 10~65535 seconds
Device ID	<input type="text" value="1"/> 1~255, unique ID for device
Alias	<input type="text" value="GRP-530"/> Max. Length = 8
Time Interval	<input type="text" value="50"/> 1~5000 ms, default=50
Data Length	<input type="text" value="1000"/> 10~1000 bytes, default=1000
Modbus TCP to RTU (Port1)	<input type="checkbox"/> Enable, COM2 --> TCP Port 10001
Modbus TCP to RTU (Port2)	<input type="checkbox"/> Enable, COM3 --> TCP Port 10002
Default Baudrate (Port1)	<input type="text" value="115200"/> bps
Default Baudrate (Port2)	<input type="text" value="115200"/> bps
Default Format (Port1)	<input type="text" value="8N1"/> (Data bit, Parity, Stop bit)
Default Format (Port2)	<input type="text" value="8N1"/> (Data bit, Parity, Stop bit)
Enable Funcion	<input type="checkbox"/> Enable
Firmware Version	v1.0.0
<input type="button" value="Modify"/>	
(1)Heartbeat Time: if this value is small, it is sensitive to detect network disconnected	
(2)Virtual IP: please set it different from other virtual COM device	

- (1) Server IP: Server IP or URL.
- (2) Server Port: the port of the server.
- (3) Heartbeat Time: if setting this value small, it is sensitive to detect network disconnected.
- (4) Device ID: ID of the device. If you set it as "1", you will find that "visual IP" is "127.53.0.1" on the server side.
- (5) Alias: an alias of device. Max. length is 8 characters.

- (6) Time Interval: if the Time Interval between the two serial port data is more than this value, the data will be sliced into two network packet. And if there is no enough time interval, but data length is over 1000 bytes (default value), the data still be sliced into two network packet.
- (7) Data Length: if serial port data length is over this value, the data will be sliced into two packets. Usually you just set this value as 1000 if you don't need this function. (this value is limited by network protocol)
- (8) Modbus TCP to RTU: Modbus/TCP to Modbus/RTU gateway function. Port1 is COM2 of the device (RS-232); Port2 is COM3 of the device (RS-485).
- (9) Default Baudrate: this value is dependent on your Modbus RTU device. Please set this value is the same as your Modbus RTU device.
- (10) Default Format: configuration of "Data bits", "Parity" and "Stop bit".
 - 8, 7 mean 8 or 7bits of Data bits
 - N, O, E mean None, Odd, Even of Parity
 - 1, 2 mean 1 or 2 bits of Stop bit
- (11) Enable Function: Enable the firmware immediately.

3.6 RTU Client

The user can configure RTU Client function here. The RTU Client function will connect to RTU Center, please refer the website for more information.

3.6.1 RTU Client

The user can configure RTU Client firmware function here. There are three tabs:

- (1) Main Info. (2) Modbus Number (3) FTP/Email

■ **Main Info. Tab:**

Main Info.	Modbus Device	FTP / Email
Server Address	<input type="text" value="192.168.12.2"/>	
Server Port	<input type="text" value="10000"/>	default=10000
Station ID	<input type="text" value="1"/>	1~65535
Data Update Period(sec.)	<input type="text" value="3"/>	0~86400 (0=disable)
Heartbeat Period(sec.)	<input type="text" value="0"/>	1~86400 (a day)
Baud Rate (RS-485 for Modbus/RTU)	<input type="text" value="9600"/> <input type="button" value="v"/> bps	
Data Bit	<input type="text" value="8"/> <input type="button" value="v"/>	
Parity	<input type="text" value="N"/> <input type="button" value="v"/>	
Stop Bit	<input type="text" value="1"/> <input type="button" value="v"/>	
Modbus Timeout (ms)	<input type="text" value="1000"/>	50~99999, default=1000
Enable Firmware	<input type="checkbox"/> Enable	
Firmware Version	v1.0.0	
<input type="button" value="Modify"/>		

- (1) Server Address: Server IP or Domain Name.
- (2) Server Port: the port of the server.
- (3) Station ID: the ID for this device. (do not be the same with other RTU device)
- (4) Data Update Period (sec.): set report time interval. The device will report all data to RTU Center every interval time your setting.
- (5) Heartbeat Period (sec.): set heartbeat time interval. 3G/GPRS connection will be

terminate by ISP, this parameter can detect broken connection early. "Heartbeat Period" must be smaller than "Data Update Period".

- (6) Baud Rate (RS-485 for Modbus/RTU): the baud rate of the RS-485 (COM3).
- (7) Data bit: the data bit of RS-485.
- (8) Parity: the parity bit of RS-485.
- (9) Stop bit: the stop bit of RS-485.
- (10) Modbus Timeout (ms): the Timeout value of Modbus.
- (11) Enable Function: enable the RTU Client function.

■ **Modbus Device: the interface for adding Modbus I/O device.**

Main Info.		Modbus Number		Email/FTP	
Modbus Device Number : 1		Add		ET-7005	
1	Name : Custom	Edit		Custom	
				ET-7002	
				ET-7005	
				ET-7015	
				ET-7016	
				ET-7017	
				ET-7017-10	
				ET-7018	
				ET-7019	
				ET-7021	

Main Info.		Modbus Device		Email/FTP	
Modbus Device Number : 0				Add ET-7050 ▼	
1		Name :		Edit Delete	
Device Name	ET-7050	Max Length=20			
Device ID	1	1~255			
IP	192.168.11.25	empty for Modbus/RTU			
Port	502	Default=502, 1~65535			
DI Number	12	0~32			
DO Number	6	0~32			
AI Number	0	0~16			
AO Number	0	0~16			
DI Address	0	0~65535			
DO Address	0	0~65535			
AI Address	0	0~65535			
AO Address	0	0~65535			
Modify Cancel					

- (1) Modbus Device Number: display the modbus device number here.
You can choose a model in the list, and then use the “Add” button to add a new modbus device.
- (2) Device Name: the Name of the modbus device. This Name will be showed in RTU Center.
- (3) Device ID: the modbus ID.
- (4) IP: the IP of modbus/TCP device. Keep it empty for Modbus/RTU device.
- (5) Port: the Port number of modbus/TCP device.
- (6) DI Number: the number of DI channel.
- (7) DO Number: the number of DO channel.
- (8) AI number: the number of AI channel.
- (9) AO number: the number of AO channel.

- (10) DI Address: the start address for reading DI value.
- (11) DO Address: the start address for reading DO value.
- (12) AI Address: the start address for reading AI value.
- (13) AO Address: the start address for reading AO value.

■ **FTP / Email:**

This function will send back all I/O data log file automatically. The period time to send is depending on “Max. Time per Log File (hour)” parameter.

Main Info.	Modbus Device	FTP / Email
Data Log Interval (sec.)	5	0~86400 (0=disable)
Max. Time per Log File (min.)	3	3~1440 minutes
FTP Server Address	61.219.167.34	empty --> disable FTP
FTP Port	221	default=21
FTP Username	test	
FTP Password	test	
Enable FTP Funcion	<input checked="" type="checkbox"/> Enable	
Email From	abc@gmail.com Ex: abc@gmail.com	empty --> disable Email
Email To	xyz@gmail.com	Ex: xyz@gmail.com
Example for 2 or more contact	xx@gmail.com,yy@gmail.com	
Email Server	smtp.gmail.com	Ex: smtp.gmail.com
Email Server Port	25	Ex: 25
Email Username	abc	Ex: abc
Email Password	123abc	Ex: 123abc
Enable Email Funcion	<input type="checkbox"/> Enable	
<input type="button" value="Modify"/>		

- (1) Data Log Interval (sec.): the time interval to record I/O data to logger file. **Set as “0” to disable all function in this tab.**
- (2) Max. Time per Log File (min.): the time interval to change log file and send log file via Email or FTP. it will change logger file before the file be over 3 MB, and move old logger

file into "LOGFILE" folder, and send out the file at the same time.

If you enable FTP or Email function, it will copy old log file into "FTP_UPLOAD" and "MAIL_UPLOAD" for sending out files.

If send FTP or Email logger file fails, it will send files next time.

- (3) FTP Server Address: FTP Server IP or Domain Name.
- (4) FTP Port: the port of the FTP server.
- (5) FTP Username: username for login
- (6) FTP password: password for login
- (7) Enable FTP Function: enable FTP report function.
- (8) Email From: the email will be sent from this address.
- (9) Email To: the email address that will receive logger file. Using "," to separate each mail address
Example:
for single receiver: xxx@gmail.com
for multi-receiver: xxx@gmail.com,yyy@gmail.com
- (10) Email Server: the server address of the email server.
- (11) Email Server Port: the server port of the email server. Usually it will be 25, 465, or 587.
- (12) Email Username: the username of your email account.
- (13) Email Password: the password of your email account.
- (14) Enable Email Function: Enable email report function.

3.6.2 FTP Test

The user can test all configure for FTP here.

FTP Configure Test	
FTP Server Address	<input type="text" value="192.168.12.2"/> empty --> disable FTP
FTP Port	<input type="text" value="21"/> default=21
FTP Username	<input type="text" value="test"/>
FTP Password	<input type="text" value="test"/>
Result	
<input type="button" value="Test"/>	

- (1) FTP Server Address: FTP Server IP or Domain Name.
- (2) FTP Port: the port of the FTP server.
- (3) FTP Username: username for login
- (4) FTP password: password for login

3.6.3 Email Test

The user can test all configure for Email here.

Email Configure Test	
Email From	<input type="text" value="abc@gmail.com"/> Ex: abc@gmail.com
Email To	<input type="text" value="xyz@gmail.com"/> Ex: xyz@gmail.com
Email Server	<input type="text" value="smtp.gmail.com"/> Ex: smtp.gmail.com
Email Server Port	<input type="text" value="25"/> Ex: 25 or 587
Email Username	<input type="text" value="abc"/> Ex: abc
Email Password	<input type="text" value="123abc"/> Ex: 123abc
Result	
<input type="button" value="Test"/>	

- (1) Email From: the email will be sent from this address.
- (2) Email To: the email address that will receive logger file. Using “,” to separate each mail address
 Example:
 for single receiver: xxx@gmail.com
 for multi-receiver: xxx@gmail.com,yyy@gmail.com
- (3) Email Server: the server address of the email server.
- (4) Email Server Port: the server port of the email server. Usually it will be 25, 465, or 587.
- (5) Email Username: the username of your email account.
- (6) Email Password: the password of your email account.
- (7) “Test” button: Pressing this button, it will send a test mail to the mail address in “Email To” field.

3.6.4 Modbus Test

The user can test all configure for Modbus here. There is the result message for testing ET-7026.

Modbus Configure Test	
Result	<pre>modbus debug start DEBUG [2014-08-15 17:20:57] [1] DI value= (0, 0) DEBUG [2014-08-15 17:20:57] [1] DO value= (0, 1) DEBUG [2014-08-15 17:20:57] [1] AI value= (65535, 65535, 65535, 65535, 65535, 65535) DEBUG [2014-08-15 17:20:57] [1] AO value= (0, 273)</pre>
<input type="button" value="Test"/>	
MODBUS Exception Codes: 01: ILLEGAL FUNCTION 02: ILLEGAL DATA ADDRESS 03: ILLEGAL DATA VALUE 04: SLAVE DEVICE FAILURE 05: ACKNOWLEDGE 06: SLAVE DEVICE BUSY 08: MEMORY PARITY ERROR 0A: GATEWAY PATH UNAVAILABLE 0B: GATEWAY TARGET DEVICE FAILED TO RESPOND	

3.7 RTU CAN Client

The user can configure RTU Client with CANBus function here. The function will connect to [RTU Center](#), please refer the website for more information.

3.7.1 Basic Configure

The user can configure basic parameter of RTU Client firmware function here.

Main Info.	
Server Address	<input type="text" value="172.18.12.2"/>
Server Port	<input type="text" value="10000"/> default=10000
Station ID	<input type="text" value="1"/> 1~65535
Data Update Period(sec.)	<input type="text" value="1"/> 0~86400 (0=disable)
Heartbeat Period(sec.)	<input type="text" value="0"/> 1~86400 (a day)
Enable Firmware	<input checked="" type="checkbox"/> Enable
Firmware Version	<input type="text"/>
<input type="button" value="Modify"/>	

- (1) Server Address: Server IP or Domain Name.
- (2) Server Port: the port of the server.
- (3) Station ID: the ID for this device. (do not be the same with other RTU device)
- (4) Data Update Period (sec.): set report time interval. The device will report all data to RTU Center every interval time your setting.
- (5) Heartbeat Period (sec.): set heartbeat time interval. 3G/GPRS connection will be terminate by ISP, this parameter can detect broken connection early. "Heartbeat Period" must be smaller than "Data Update Period".
- (6) Enable Function: enable the RTU Client function.

3.7.2 CAN Configure

The user can configure CAN bus parameter here. The can data will be mapping to AI field of the RTU function.

CAN Configure			
CAN Baud Rate		1000K ▼	please reboot after changing baudrate
Group:		1 ▼	
ai-index	CAN mode(0/1:11/29bits)	CAN ID	CAN data index
0	0	1	0
1			
2			
3			
4			
5			
6			
7			
8			
9			
10			
11			
12			
13			
14			
15			
<input type="button" value="Modify"/>			

- (1) CAN Baud Rate: configure baud rate here.
- (2) Group: there are 10 group in RTU function, the user can configure CAN data (a byte) fill to the ai point that you choose.
- (3) ai-index: a group have 16 ai point, from 0 to 15.
- (4) CAN mode: 0 is 11-bit, and 1 is 29-bit.
- (5) CAN ID: the ID of the CAN message that you want to catch.
- (6) CAN data index: Max CAN message length is 8 (range is 0~7), the user can choose an index data fill into AI field of RTU.

3.7.3 FTP/ Email

This function will send back all I/O data log file automatically. The period time to send is depending on “Max. Time per Log File (min.)” parameter.

Main Info.	Modbus Device	FTP / Email
Data Log Interval (sec.)	5	0~86400 (0=disable)
Max. Time per Log File (min.)	3	3~1440 minutes
FTP Server Address	61.219.167.34	empty --> disable FTP
FTP Port	221	default=21
FTP Username	test	
FTP Password	test	
Enable FTP Funcion	<input checked="" type="checkbox"/> Enable	
Email From	abc@gmail.com Ex: abc@gmail.com	empty --> disable Email
Email To	xyz@gmail.com	Ex: xyz@gmail.com
Example for 2 or more contact	xx@gmail.com,yy@gmail.com	
Email Server	smtp.gmail.com	Ex: smtp.gmail.com
Email Server Port	25	Ex: 25
Email Username	abc	Ex: abc
Email Password	123abc	Ex: 123abc
Enable Email Funcion	<input type="checkbox"/> Enable	
<input type="button" value="Modify"/>		

- (1) Data Log Interval (sec.): the time interval to record I/O data to logger file. Set as “0” to disable all function in this tab.
- (2) Max. Time per Log File (min.): the time interval to change log file and send log file via Email or FTP. it will change logger file before the file be over 3 MB, and move old logger file into “LOGFILE” folder, and send out the file at the same time.
If you enable FTP or Email function, it will copy old log file into “FTP_UPLOAD” and “MAIL_UPLOAD” for sending out files.
If send FTP or Email logger file fails, it will send files next time.
- (3) FTP Server Address: FTP Server IP or Domain Name.

- (4) FTP Port: the port of the FTP server.
- (5) FTP Username: username for login
- (6) FTP password: password for login
- (7) Enable FTP Function: enable FTP report function.
- (8) Email From: the email will be sent from this address.
- (9) Email To: the email address that will receive logger file. Using “,” to separate each mail address

Example:

for single receiver: xxx@gmail.com

for multi-receiver: xxx@gmail.com,yyy@gmail.com

- (10) Email Server: the server address of the email server.
- (11) Email Server Port: the server port of the email server. Usually it will be 25, 465, or 587.
- (12) Email Username: the username of your email account.
- (13) Email Password: the password of your email account.
- (14) Enable Email Function: Enable email report function.

4. Example

4.1 3G/4G Router Application

This example shows the steps to share 3G/4G network to 3 XPac8000.



(1) Please configure the Ethernet of XPac8000 as:

IP=192.168.0.10 ~ 12

Mask="255.255.0.0"

gateway = "192.168.27.31".

(2) Set the Ethernet IP.

Ethernet	
IP Address	<input type="text" value="192.168.27.31"/>
Mask	<input type="text" value="255.255.0.0"/>
Gateway	<input type="text"/>
<input type="button" value="Modify"/>	

(3) Set Pin code of your SIM card.

Set "User Name" and "Password" if your SIM card need it.

Press "Modify" to save

PIN / APN Configure	
PIN Code	<input type="text" value="0000"/>
Phone Number	<input type="text" value="*99***1#"/> (1)
APN	<input type="text" value="internet"/> (2)
User Name	<input type="text"/> (2)
Password	<input type="text"/> (2)
<input type="button" value="Modify"/>	
(1):usually use *99# or *99***1#	
(2):please ask your SIM Card provider	

(4) Enable "Network Reconnection" function to keep your mobile network always online (usually, ISP will disconnect your connection once every 1~3 days).

Generally, you can set the Server IP as your server's IP or google's DNS server IP (8.8.8.8). If you use MDVPN, please set the Server IP as your Server IP that doesn't deny ICMP service (Ping).

Press "Modify" after you finish all settings.

Network Reconnection	
Server IP	<input type="text" value="8.8.8.8"/>
Max. Retry	<input type="text" value="5"/>
Retry Interval Time	<input type="text" value="30"/>
Enable Funcion	<input checked="" type="checkbox"/> Enable
<input type="button" value="Modify"/>	
(1):This function will run immediately after you press "Modify" button	
(2):GSM module will be reset after Max. retry	
(3):System will reboot after GSM module reset 100 times	

(5) Set routing rule to share 3G/4G network. This setting will share 3G network to IP address from 192.168.0.1~192.168.0.255.

Press "Modify"

ROUTING Rule			
Rule NO.	IP	Mask	Target
0	192.168.0.1	24 ▾	ppp0 ▾
1		▾	▾
2		▾	▾
3		▾	▾
4		▾	▾
5		▾	▾
6		▾	▾
7		▾	▾
8		▾	▾
9		▾	▾

(6) Please reboot the device to enable settings.

Information
[--Device Info](#)
[--Network Info](#)
[--Storage Info](#)

Network
[--Ethernet](#)
[--2G/3G](#)
[--DNS](#)
[--DDNS](#)
[--DHCP Server](#)
[--Routing](#)
[--Port Mapping](#)
[--Diagnostic](#)

Process
[--System](#)
[--User](#)

System
[--Password](#)
[--Reboot](#)
[--Backup/Restore](#)

Notice!!

Are you sure to reboot? please wait a minute for system rebooting after you press reboot button.



4.2 Web Server and IP Camera Application

This example shows the steps to share 3G/4G network to ET-7044 and IP camera.



(1) Please Set the Ethernet of ET-7044 and IP camera as:

IP=192.168.0.20 ~ 22

Mask="255.255.0.0"

gateway = "192.168.27.31"

(2) Set the IP as below:

IP="192.168.27.31"

Mask="255.255.0.0"

Ethernet	
IP Address	<input type="text" value="192.168.27.31"/>
Mask	<input type="text" value="255.255.0.0"/>
Gateway	<input type="text"/>
<input type="button" value="Modify"/>	

(3) Set Pin code of your SIM card.

Set "User Name" and "Password" if your SIM card needs it.

Press "Modify"

PIN / APN Configure	
PIN Code	<input type="text" value="0000"/>
Phone Number	<input type="text" value="*99***1#"/> (1)
APN	<input type="text" value="internet"/> (2)
User Name	<input type="text"/> (2)
Password	<input type="text"/> (2)
<input type="button" value="Modify"/>	
(1):usually use *99# or *99***1#	
(2):please ask your SIM Card provider	

(4) Enable "Network Reconnection" function to keep your mobile network always online (usually, ISP will disconnect your connection once every 1~3 days).

Generally, you can set the Server IP as your server's IP or Google's DNS server IP (8.8.8.8). If you use MDVPN, please set the Server IP as your Server IP that doesn't deny ICMP service (Ping).

Press "Modify" after you finish all settings.

Network Reconnection	
Server IP	<input type="text" value="8.8.8.8"/>
Max. Retry	<input type="text" value="5"/>
Retry Interval Time	<input type="text" value="30"/>
Enable Funcion	<input checked="" type="checkbox"/> Enable
<input type="button" value="Modify"/>	
(1):This function will run immediately after you press "Modify" button	
(2):GSM module will be reset after Max. retry	
(3):System will reboot after GSM module reset 100 times	

(5) Set “Port Mapping Rule” to let user access the device behind GRP device via the internet. This setting will bind the port of 3G interface to “Target IP:Target Port”.

Port 12080 of 3G interface 192.168.0.20:80

Port 12180 of 3G interface 192.168.0.21:80

Port 12280 of 3G interface 192.168.0.22:80

Information

--[Device Info](#)

--[Network Info](#)

--[Storage Info](#)

Network

--[Ethernet](#)

--[2G/3G](#)

--[DNS](#)

--[DDNS](#)

--[DHCP Server](#)

--[Routing](#)

--[Port Mapping](#)

--[Diagnostic](#)

Process

--[System](#)

--[User](#)

System

--[Password](#)

--[Reboot](#)

--[Backup/Restore](#)

--[Restore Factory](#)

Port Mapping Rule					
Rule NO.	Type	From	Port	Target IP	Target Port
0	TCP	ppp0	12080	192.168.0.20	80
1	TCP	ppp0	12180	192.168.0.21	80
2	TCP	ppp0	12280	192.168.0.22	80
3					
4					
5					
6					
7					
8					
9					

(6) Please reboot the device to enable settings. (you can reboot from the web or the power source)

Information

--[Device Info](#)

--[Network Info](#)

--[Storage Info](#)

Network

--[Ethernet](#)

--[2G/3G](#)

--[DNS](#)

--[DDNS](#)

--[DHCP Server](#)

--[Routing](#)

--[Port Mapping](#)

--[Diagnostic](#)

Process

--[System](#)

--[User](#)

System

--[Password](#)

--[Reboot](#)

--[Backup/Restore](#)

Notice!!

Are you sure to reboot? please wait a minute for system rebooting after you press reboot button.

(7) Please type the IP address or domain name of GRP device in 3G/4G network. You will look as below. (It maybe like “mygrp5k.no-ip.org:12080”.)

ICP DAS
http://www.icpdas.com

Welcome to the ET-7000 Web configuration page

Model Name	ET-7044
MAC Address	00:0d:e0:64:44:8c
Module Information	
Firmware Version	1.3.0 (Mar 26 2012)
IO Version	1.09
OS Version	2.2.10 (Jun 4 2009)
DI channels	8
DO channels	8
AI channels	0
AO channels	0

(8) If you want to see the IP Camera image from web browser, please type the IP address or domain name of GRP device in 3G/4G network. (It may be like “mygrp5k.no-ip.org:12180”.)

4.3 Remote I/O Control / Temperature Monitor

This example shows remote control application via “serial port to 3G/4G gateway function”.



- (1) Please connect your device (DL-100 or PLC) to serial port of GRP device:
- (2) If you never use VxServer, please refer the link as below:

<http://m2m.icpdas.com/VxServer.html>

you need download VxServer software and VxComm software, and install it on your control center.

- (3) Set Pin code of your SIM card, and Enable “Auto-Dialing” function.
Set “User Name” and “Password” if your SIM card needs it.
Press “Modify”

PIN / APN Configure	
PIN Code	<input type="text" value="0000"/>
Phone Number	<input type="text" value="*99***1#"/> (1)
APN	<input type="text" value="internet"/> (2)
User Name	<input type="text"/> (2)
Password	<input type="text"/> (2)
<input type="button" value="Modify"/>	
(1): usually use *99# or *99***1#	
(2): please ask your SIM Card provider	

- (4) Enable “Network Reconnection” function to keep your mobile network always online (usually, ISP will disconnect your connection once every 1~3 days).

Generally, you can set the Server IP as your server’s IP or Google’s DNS server IP (8.8.8.8). If you use MDVPN, please set the Server IP as your Server IP that doesn’t deny ICMP service (Ping).

Press “Modify” after you finish all settings.

Network Reconnection	
Server IP	<input type="text" value="8.8.8.8"/>
Max. Retry	<input type="text" value="5"/>
Retry Interval Time	<input type="text" value="30"/>
Enable Funcion	<input checked="" type="checkbox"/> Enable
<input type="button" value="Modify"/>	
<p>(1):This function will run immediatly after you press "Modify" button (2):GSM module will be reset after Max. retry (3):System will reboot after GSM module reset 100 times</p>	

- (5) Configure VxServer Function.

Set “Server IP” and “Server Port”, the default port number is “11000”.

Let other settings be default value.

Click “Enable Function” to enable VxServer function.

Press “Modify”, and device will try to connect to server.

Virtual COM Function (VxServer)	
Server IP	192.168.12.2
Server Port	11000 default=11000
Heartbeat Time	10 10~65535 seconds
Device ID	1 1~255, unique ID for device
Alias	GRP-530 Max. Length = 8
Time Interval	50 1~5000 ms, default=50
Data Length	1000 10~1000 bytes, default=1000
Modbus TCP to RTU (Port1)	<input type="checkbox"/> Enable, COM2 --> TCP Port 10001
Modbus TCP to RTU (Port2)	<input type="checkbox"/> Enable, COM3 --> TCP Port 10002
Default Baudrate (Port1)	115200 bps
Default Baudrate (Port2)	115200 bps
Default Format (Port1)	8N1 (Data bit, Parity, Stop bit)
Default Format (Port2)	8N1 (Data bit, Parity, Stop bit)
Enable Funcion	<input checked="" type="checkbox"/> Enable
Firmware Version	v1.0.0
<input type="button" value="Modify"/>	
(1)Heartbeat Time: if this value is small, it is sensitive to detect network disconnected (2)Virtual IP: please set it different from other virtual COM device	

- (6) Please reset your device and un-plug your Ethernet from GRP device, it will dial-up in 60 seconds, and then it will connect to your control center.

Virtual IP	Module	Alias	Com Number	Heartbeat	Remote Client IP	Remote Client Port	Sig
127.53.0.1	GRP-520_GRP-530	GRP-530	2	10	192.168.27.31	51776	

- (7) After GRP device connect to VxServer, please follow steps below:
- Press “Search Servers” button, you will get a device list.
 - Click right button of the mouse on “GRP-520_GRP-530”
 - Click “Add Server”.
 - Choose the virtual com port number
 - change setting tab to “Server Options”, and then set as screenshot. (you software polling time-out must more than 3 sec.
 - click “OK”

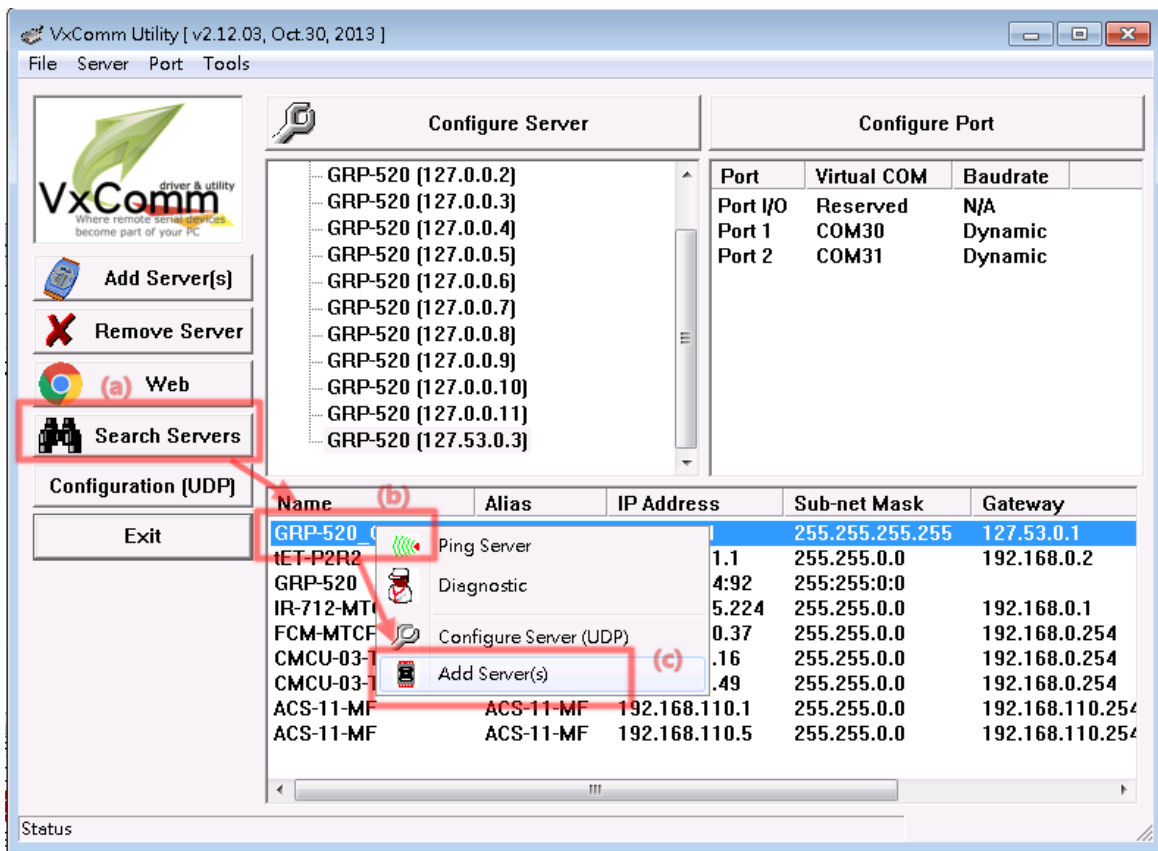

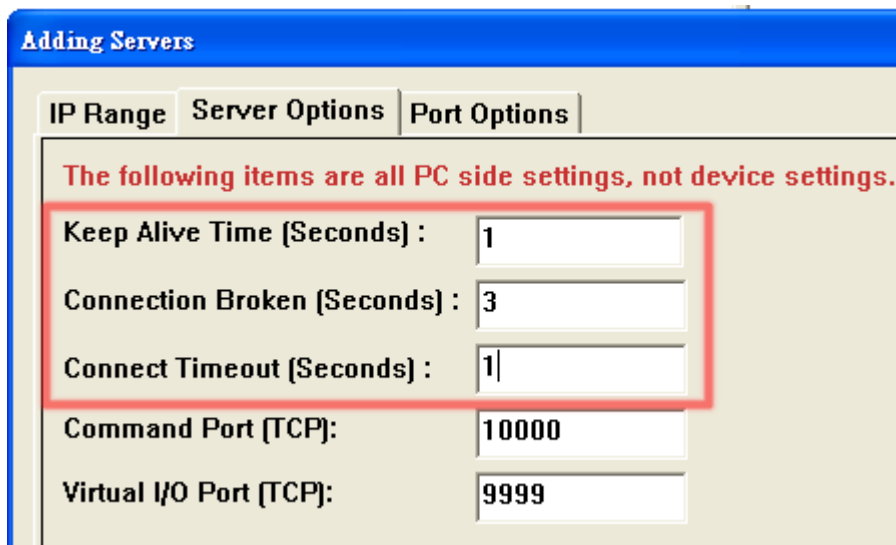
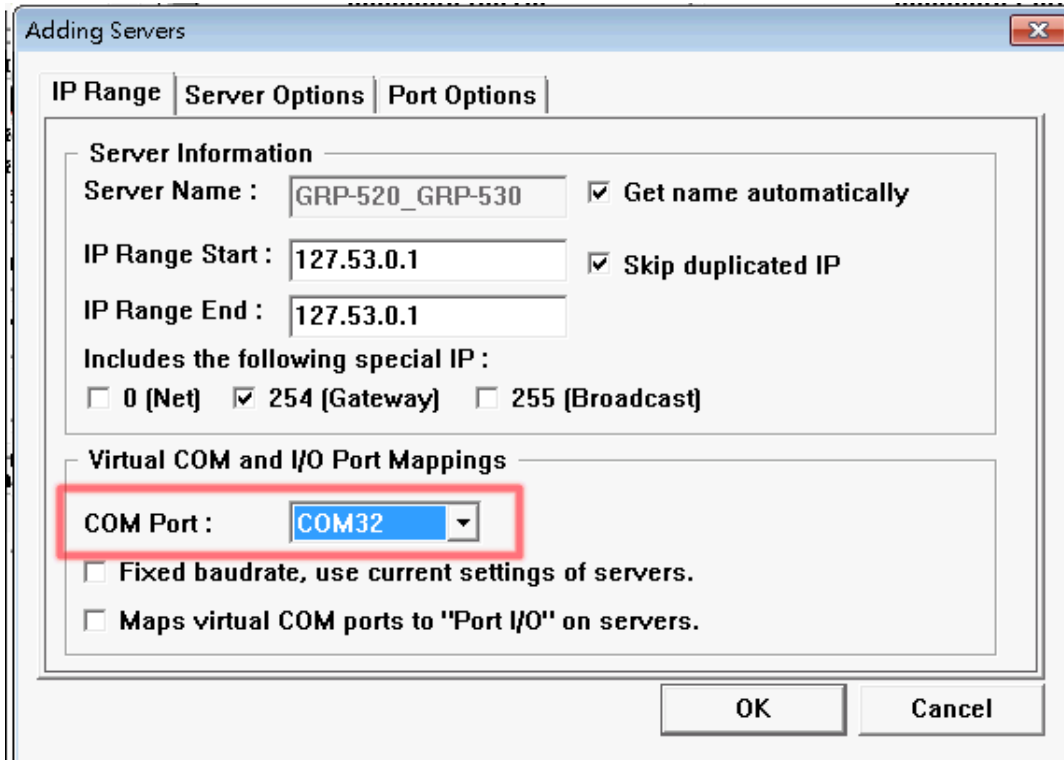

- (8) You will see virtual com port: COM32, COM33, but it can't be opened.
 Click "tool"/"Restart Driver" to restart VxComm driver.
 Open com port to connect your device.
 (In this case, COM32 is RS-232, COM33 is RS-485 of GRP device.)

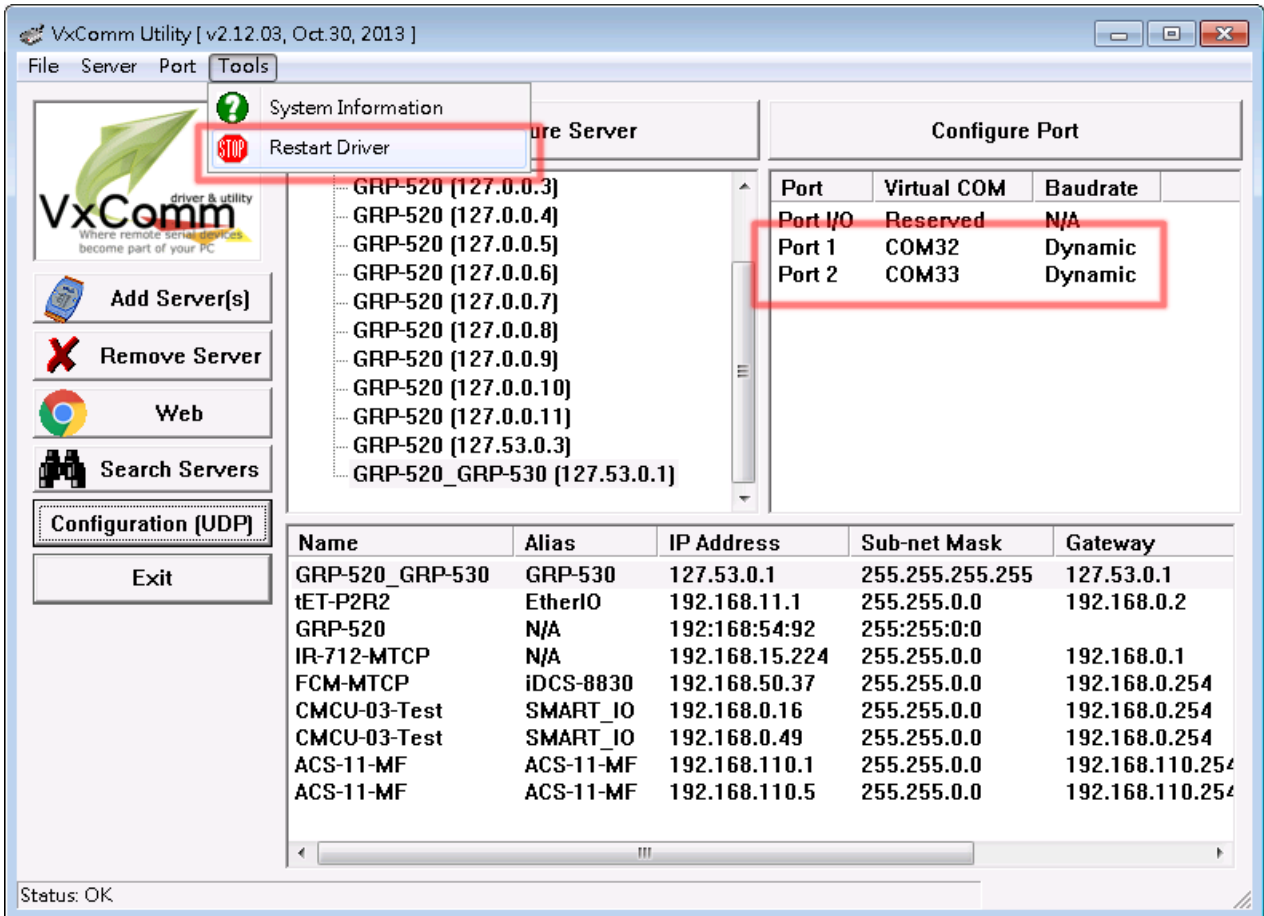

4.4 Modbus/TCP to Modbus/RTU over 3G, and Card Reader Monitor

This example shows Modbus/TCP to Modbus/RTU over 3G/4G function”.

After steps below, please set “IP:Port” of Modbus/TCP program as “127.0.20.1:10001” on your control center (Port 10001 is RS-232; Port 10002 is RS-485)



- (1) Please connect your device (M-7017 or PLC) to RS-485 of GRP device.
Baudrate of Modbus device is 9600 bps, data format is 8N1 (Data bits, Parity, Stop bits).
Baudrate of Card Reader is 115200 bps
- (2) If you never use VxServer, please refer the link as below:
<http://m2m.icpdas.com/VxServer.html>
you need download VxServer software and VxComm software, and install it on your control center.
- (3) Set Pin code of your SIM card, and Enable “Auto-Dialing” function.
Set “User Name” and “Password” if your SIM card needs it.
Press “Modify”

PIN / APN Configure	
PIN Code	0000
Phone Number	*99***1# (1)
APN	internet (2)
User Name	(2)
Password	(2)
<input type="button" value="Modify"/>	
(1):usually use *99# or *99***1#	
(2):please ask your SIM Card provider	

- (4) Enable “Network Reconnection” function to keep your mobile network always online (usually, ISP will disconnect your connection once every 1~3 days).

Generally, you can set the Server IP as your server’s IP or Google’s DNS server IP (8.8.8.8). If you use MDVPN, please set the Server IP as your Server IP that doesn’t deny ICMP service (Ping).

Press “Modify” after you finish all settings.

Network Reconnection	
Server IP	8.8.8.8
Max. Retry	5
Retry Interval Time	30
Enable Funcion	<input checked="" type="checkbox"/> Enable
<input type="button" value="Modify"/>	
(1):This function will run immediately after you press "Modify" button	
(2):GSM module will be reset after Max. retry	
(3):System will reboot after GSM module reset 100 times	

(5) Configure VxServer Function.

Set "Server IP" and "Server Port", the default port number is "11000".

For Card Reader:

Please just set Port1 (RS-232) as default value.

For Modbus RTU device: (Port2, RS-485)

Please configure as below

Click "Enable Function" to enable VxServer function.

Press "Modify", and GRP device will try to connect to server.

Virtual COM Function (VxServer)	
Server IP	<input type="text" value="192.168.12.2"/>
Server Port	<input type="text" value="11000"/> default=11000
Heartbeat Time	<input type="text" value="10"/> 10~65535 seconds
Device ID	<input type="text" value="1"/> 1~255, unique ID for device
Alias	<input type="text" value="GRP-530"/> Max. Length = 8
Time Interval	<input type="text" value="50"/> 1~5000 ms, default=50
Data Length	<input type="text" value="1000"/> 10~1000 bytes, default=1000
Modbus TCP to RTU (Port1)	<input type="checkbox"/> Enable, COM2 --> TCP Port 10001
Modbus TCP to RTU (Port2)	<input checked="" type="checkbox"/> Enable, COM3 --> TCP Port 10002
Default Baudrate (Port1)	<input type="text" value="115200"/> bps
Default Baudrate (Port2)	<input type="text" value="9600"/> bps
Default Format (Port1)	<input type="text" value="8N1"/> (Data bit, Parity, Stop bit)
Default Format (Port2)	<input type="text" value="8N1"/> (Data bit, Parity, Stop bit)
Enable Funcion	<input checked="" type="checkbox"/> Enable
Firmware Version	v1.0.0
<input type="button" value="Modify"/>	
(1)Heartbeat Time: if this value is small, it is sensitive to detect network disconnected (2)Virtual IP: please set it different from other virtual COM device	

- (6) Please reset your device and un-plug your Ethernet from GRP device, it will dial-up in 60 seconds, and then it will connect to your control center.

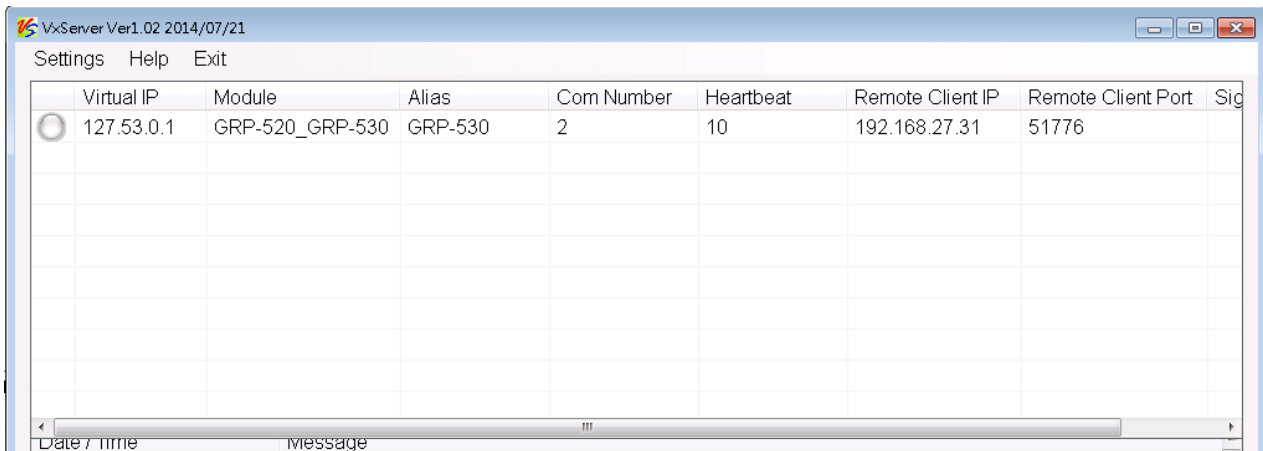

- (7) After GRP device connect to VxServer, please follow steps below:
- Press “Search Servers” button, you will get a device list.
 - Click right button of the mouse on “GRP-520_GRP-530”
 - Click “Add Server”.
 - choose the virtual com port number, and click “OK”

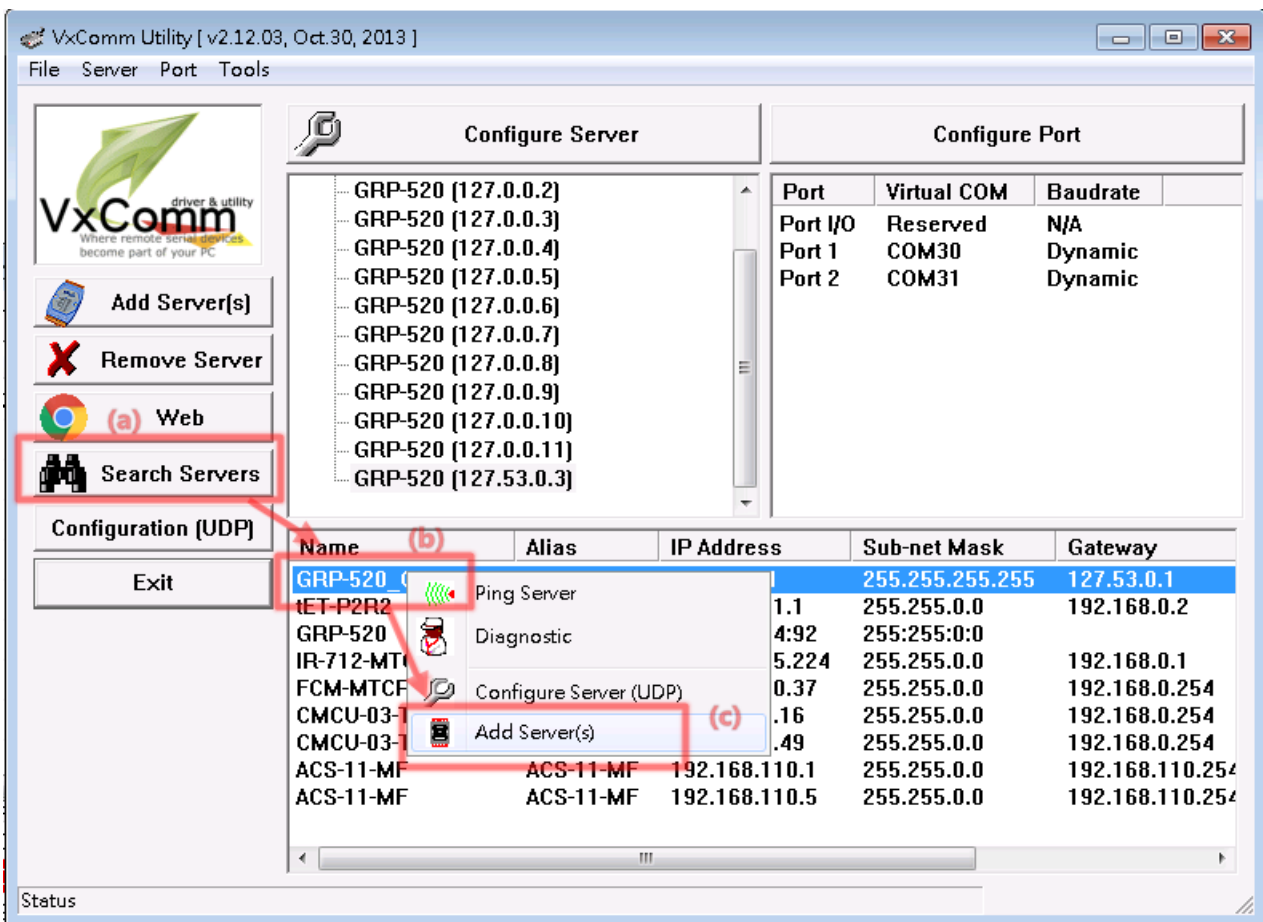

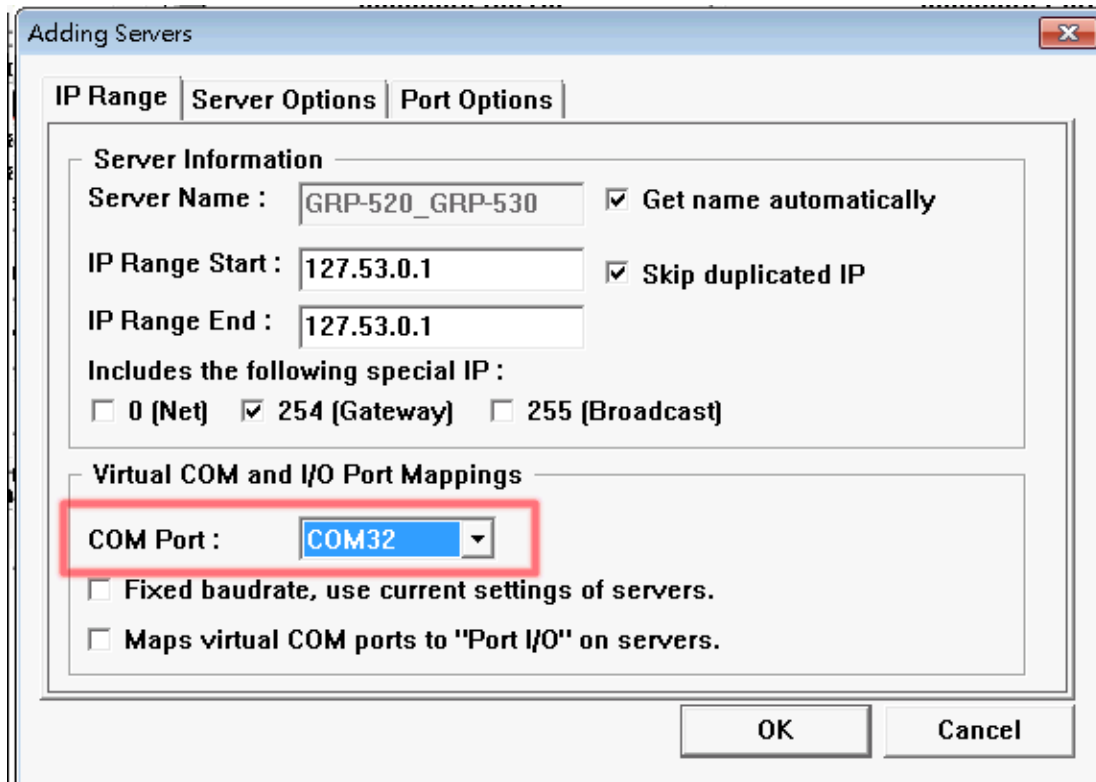

- (8) You will see virtual com port: COM32, COM33, but it can't be opened.
Click "tool"/"Restart Driver" to restart VxComm driver.
Open com port to connect your device.
(In this case, COM32 is RS-232, COM33 is RS-485 of GRP device. Please don't open COM33, because it's Modbus/TCP to Modbus/RTU mode)

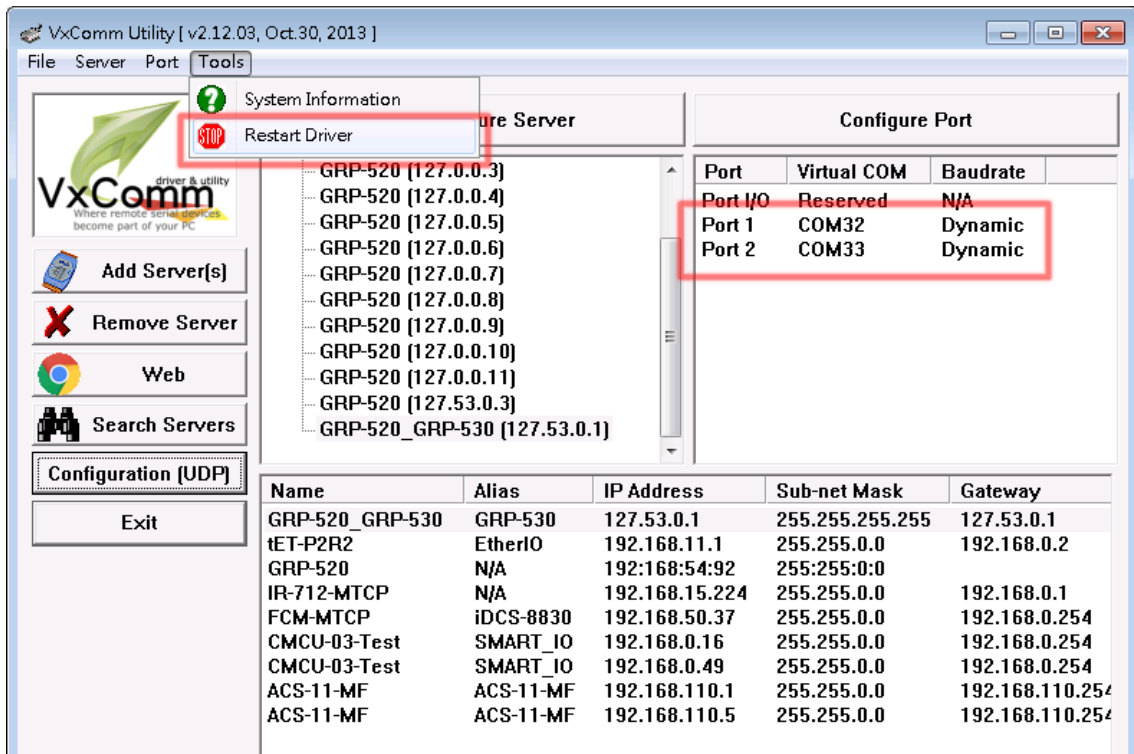

4.5 RTU Client for Remote Control Application with RTU API.

This example shows how to use RTU API to collect and control remote Modbus/RTU and Modbus/TCP I/O with RTU Client / Server.

There are ET-7017, M-7045, and a PLC in this system.

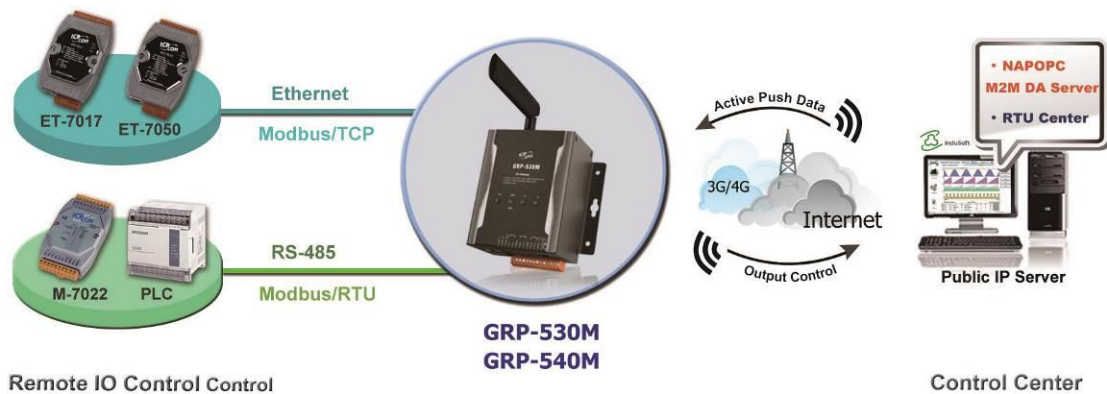

(1) Please connect your device (ET-7k or M-7k modules) to Ethernet or RS-485 of GRP device:

(2) If you never use RTU Center, please refer the link as below:

http://m2m.icpdas.com/m2m_rtu.html

If you need OPC solution, please refer the link as below:

http://m2m.icpdas.com/NAPOPC_M2M.html

If you need RTU library to develop your own software, please refer the link as below:

http://m2m.icpdas.com/m2m_rtu_api.html

(3) Set Pin code of your SIM card, and Enable “Auto-Dialing” function.

Set “User Name” and “Password” if your SIM card needs it.

Press “Modify”

PIN / APN Configure	
PIN Code	<input type="text" value="0000"/>
Phone Number	<input type="text" value="*99***1#"/> (1)
APN	<input type="text" value="internet"/> (2)
User Name	<input type="text"/> (2)
Password	<input type="text"/> (2)
<input type="button" value="Modify"/>	
(1):usually use *99# or *99***1# (2):please ask your SIM Card provider	

(4) Enable “Network Reconnection” function to keep your mobile network always online (usually, ISP will disconnect your connection once every 1~3 days).

Generally, you can set the Server IP as your server’s IP or Google’s DNS server IP (8.8.8.8). If you use MDVPN, please set the Server IP as your Server IP that doesn’t deny ICMP service (Ping).

Press “Modify” after you finish all settings.

Network Reconnection	
Server IP	<input type="text" value="8.8.8.8"/>
Max. Retry	<input type="text" value="5"/>
Retry Interval Time	<input type="text" value="30"/>
Enable Funcion	<input checked="" type="checkbox"/> Enable
<input type="button" value="Modify"/>	
<p>(1):This function will run immediatly after you press "Modify" button (2):GSM module will be reset after Max. retry (3):System will reboot after GSM module reset 100 times</p>	

(5) Add ET-7050 in “Modbus Device” tab.

choose ET-7050 in the list, and then press “Add” button.

Main Info.	Modbus Device	Email/FTP
Modbus Device Number : 0	<input type="button" value="Add"/> <div style="border: 1px solid black; padding: 2px;"> ET-7050 ▼ ET-7042 ▲ ET-7044 ET-7050 ET-7051 </div>	

- (6) The web will bring out all I/O number information as below. Please modify “Device Name”, “Device ID”, “IP” and “Port” for your ET-7050.
 (Device Name: an alias name of your device, you can modify as you need.)
 Press “Modify” to add a device.

Main Info.		Modbus Device		Email/FTP	
Modbus Device Number : 0			<input type="button" value="Add"/> <input type="text" value="ET-7050"/>		
1		Name :		<input type="button" value="Edit"/> <input type="button" value="Delete"/>	
Device Name	<input type="text" value="ET-7050"/>	Max Length=20			
Device ID	<input type="text" value="1"/>	1~255			
IP	<input type="text" value="192.168.11.25"/>	empty for Modbus/RTU			
Port	<input type="text" value="502"/>	Default=502, 1~65535			
DI Number	<input type="text" value="12"/>	0~32			
DO Number	<input type="text" value="6"/>	0~32			
AI Number	<input type="text" value="0"/>	0~16			
AO Number	<input type="text" value="0"/>	0~16			
DI Address	<input type="text" value="0"/>	0~65535			
DO Address	<input type="text" value="0"/>	0~65535			
AI Address	<input type="text" value="0"/>	0~65535			
AO Address	<input type="text" value="0"/>	0~65535			
<input type="button" value="Modify"/> <input type="button" value="Cancel"/>					

(7) Add M-7022 in “Modbus Device” tab.

choose M-7022 in the list, and then press “Add” button. We will see the screenshot as below.

The web will bring out all I/O number information. Please modify “Device Name” and “Device ID” for your M-7022. (Don’t modify “IP” and “Port” settings).

Press “Modify” to add a device.

(8) Add PLC in “Modbus Device” tab. (communication with RS-485)

choose “Custom” in the list, and then press “Add” button. We will see the screenshot as below.

Here we set the “Device Name”, “Device ID”, “DI Number”, “AI Number” for the PLC.

Press “Modify” to add a device.

Main Info.		Modbus Device		Email/FTP	
Modbus Device Number : 2			<input type="button" value="Add"/> <input type="text" value="Custom"/>		
1	Name : ET-7050		<input type="button" value="Edit"/> <input type="button" value="Delete"/>		
2	Name : M-7022		<input type="button" value="Edit"/> <input type="button" value="Delete"/>		
3	Name :		<input type="button" value="Edit"/> <input type="button" value="Delete"/>		
Device Name	<input type="text" value="myPLC"/>	Max Length=20			
Device ID	<input type="text" value="1"/>	1~255			
IP	<input type="text"/>	empty for Modbus/RTU			
Port	<input type="text" value="502"/>	Default=502, 1~65535			
DI Number	<input type="text" value="4"/>	0~32			
DO Number	<input type="text" value="0"/>	0~32			
AI Number	<input type="text" value="4"/>	0~16			
AO Number	<input type="text" value="0"/>	0~16			
DI Address	<input type="text" value="0"/>	0~65535			
DO Address	<input type="text" value="0"/>	0~65535			
AI Address	<input type="text" value="0"/>	0~65535			
AO Address	<input type="text" value="0"/>	0~65535			
<input type="button" value="Modify"/> <input type="button" value="Cancel"/>					

(9) Three devices we set as below:

Main Info.		Modbus Device	Email/FTP
Modbus Device Number : 3			Add Custom ▾
1	Name : ET-7050		Edit Delete
2	Name : M-7022		Edit Delete
3	Name : myPLC		Edit Delete

(10) Please choose “Modbus Test” function, and press “Test” button to test our settings.
If the result is successful, the screenshot will be as below, and please follow next step.

The screenshot shows the 'Modbus Configure Test' window with a 'success' status at the top. The 'Result' pane contains the following text:

```

invalid object in data, converting to string
invalid object in data, converting to string
modbus debug start
DEBUG [2014-08-18 15:55:56] [1] DI value= (0, 0, 0, 0, 0, 0, 0, 0, 0, 0, 0, 0)
DEBUG [2014-08-18 15:55:56] [1] DO value= (0, 0, 0, 0, 0, 0)
DEBUG [2014-08-18 15:55:56] [2] AO value= (291, 256)
DEBUG [2014-08-18 15:55:56] [3] DI value= (1, 1, 0, 0)
DEBUG [2014-08-18 15:55:56] [3] AI value= (0, 0, 0, 0)
  
```

A 'Test' button is visible at the bottom of the window. On the left sidebar, the 'Modbus Test' option is highlighted with a red box and an arrow pointing to the main window.

If result is fail, the screenshot will be as below. Please check your settings or the wire connection.

The screenshot shows the 'Modbus Configure Test' window with a 'fails' status at the top. The 'Result' pane contains the following text:

```

invalid object in data, converting to string
invalid object in data, converting to string
modbus debug start
ERROR [2014-08-18 16:10:55] MB[1] poll_modbus(): timed out
DEBUG [2014-08-18 16:10:55] [2] AO value= (291, 256)
DEBUG [2014-08-18 16:10:55] [3] DI value= (1, 1, 0, 0)
DEBUG [2014-08-18 16:10:55] [3] AI value= (0, 0, 0, 0)
[2014-08-18 16:10:54] modbus error
[ET-7050,1] Exception: timed out
  
```

The error message 'ERROR [2014-08-18 16:10:55] MB[1] poll_modbus(): timed out' is highlighted with a red box. A 'Test' button is visible at the bottom of the window.

(11) Configure “Main Info.” Tab.

- Set “Server Address” and “Server Port” of your server that running RTU Center.
- Set Station ID, and don’t be the same with another RTU device.
- Set “Data Update Period” and “Heartbeat Period”. (0 disable)
- Configure the parameters of RS-485 for Modbus/RTU.

Main Info.	Modbus Device	FTP / Email
Server Address	<input type="text" value="192.168.1.102"/>	
Server Port	<input type="text" value="10000"/>	default=10000
Station ID	<input type="text" value="1"/>	1~65535
Data Update Period(sec.)	<input type="text" value="3"/>	0~86400 (0=disable)
Heartbeat Period(sec.)	<input type="text" value="0"/>	1~86400 (a day)
Baud Rate (RS-485 for Modbus/RTU)	<input type="text" value="9600"/> <input type="button" value="v"/> bps	
Data Bit	<input type="text" value="8"/> <input type="button" value="v"/>	
Parity	<input type="text" value="N"/> <input type="button" value="v"/>	
Stop Bit	<input type="text" value="1"/> <input type="button" value="v"/>	
Modbus Timeout (ms)	<input type="text" value="1000"/>	50~99999, default=1000
Enable Firmware	<input checked="" type="checkbox"/> Enable	
Firmware Version	v1.0.0	
<input type="button" value="Modify"/>		

- (12) Download RTU Center from:
http://m2m.icpdas.com/m2m_rtu.html
and then extract “RTU Center”.

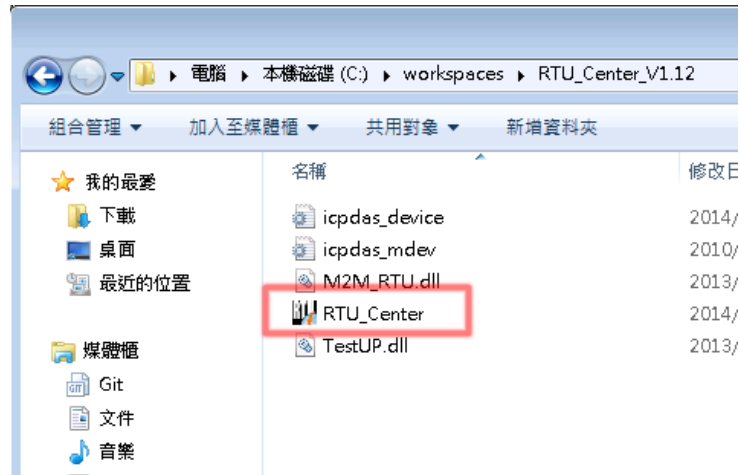

Or you can install NAPOPC.M2M DA Server, it contains RTU Center.

Please download install file from:

http://m2m.icpdas.com/NAPOPC_M2M.html

- (13) Execute RTU Center, and add a RTU device in RTU Center.

- Click “New Device” icon.
- Input the alias name of your device
- Choose module type as “GRP-520” (no this item in new version RTU Center)
- Set Station ID as “1”, and then press “OK” button.

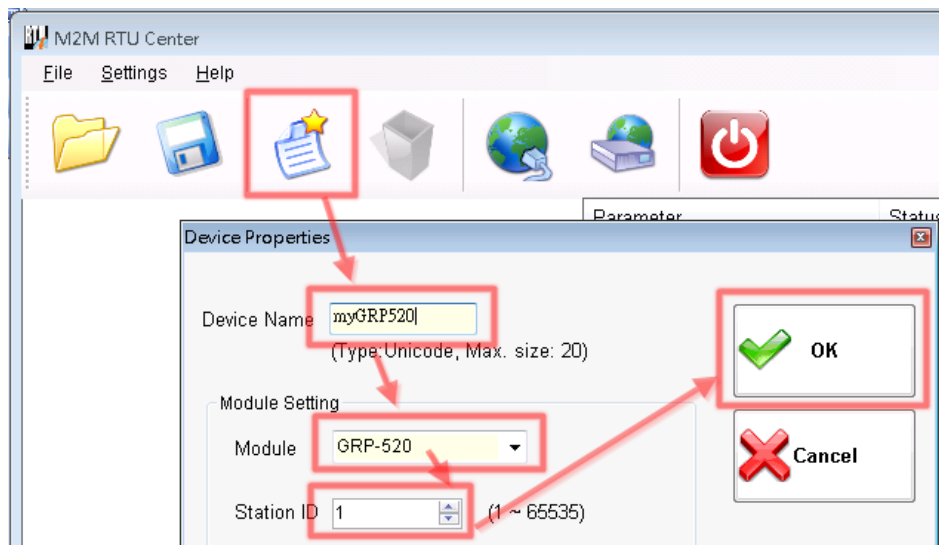

(14) GRP device will connect to RTU Center later, and screenshot as below.

The screenshot shows the M2M RTU Center software interface. The title bar reads "M2M RTU Center". The menu bar includes "File", "Settings", and "Help". The toolbar contains icons for folders, a floppy disk, a document with a star, a box, a globe with a hand, a server rack, and a power button. The left sidebar shows a tree view with "myGRP520" selected, containing sub-items: "Local IO", "ET-7050", "M-7022", and "myPLC". The main area is divided into two tables.

Parameter	Status
Device Name	myGRP520
Module	GRP-520
Station ID	1
Describe	
Connected Priority	GPRS Master, Ethernet Slave
Connected Method	Ethernet
Date&Time	2014/08/20 15:37:34
Remote Client IP	192.168.27.50
Remote Client PORT	44665
Send once time (unit: sec)	5
Heartbeat time (unit: sec)	0
Modbus module number	3

Date / Time	Message
2014/08/20 15:34:23.297	Station [1] established the connection!!(Ethernet) (IP: 192.168.27.50, PORT: 44665)
2014/08/20 15:34:23.254	Add a new device "myGRP520" (Module Name=GRP-520, Station ID=1)

(15) You can double click on "ET-7050" to bring out "Output control panel", and press "DO1" to control remote DO.

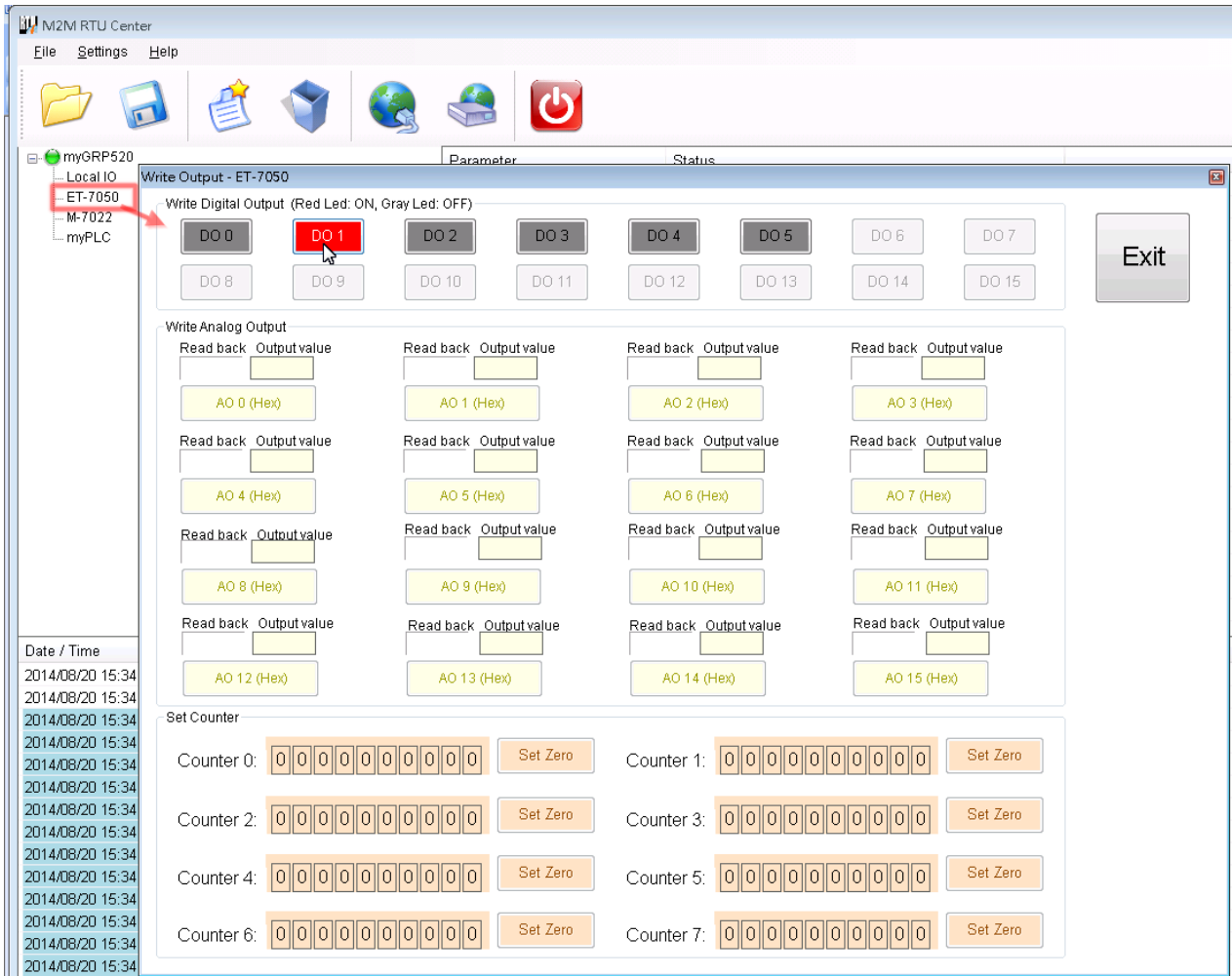

(16) Download RTU API from RTU Center web page, and extract it. There are RTU API library and some demo for C#, VB.Net, VC6 as below.

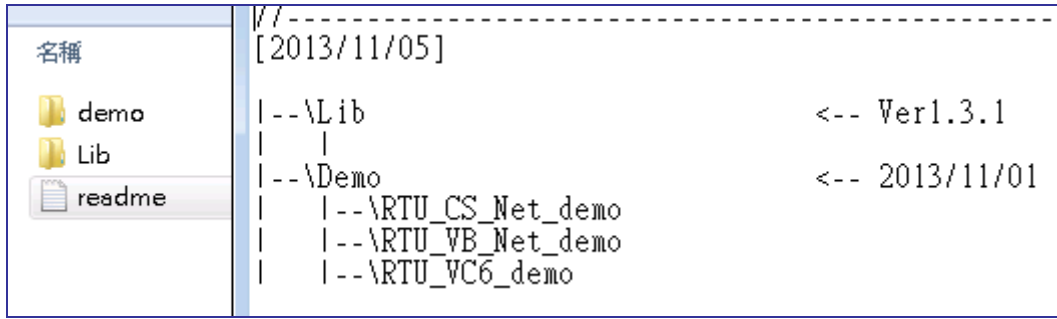

- (17) Copy pre-building demo into folder of RTU Center. (demo must be in the same folder with RTU Center, because they use the same share memory in M2M_RTU.dll)
Here we copy two file “RTU_CS_demo.exe” and “M2M_RTU_NET.dll” from C# demo.

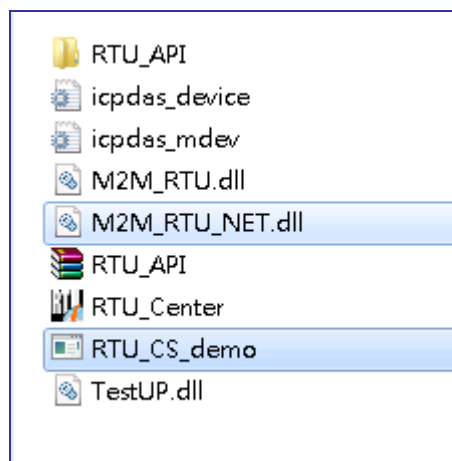
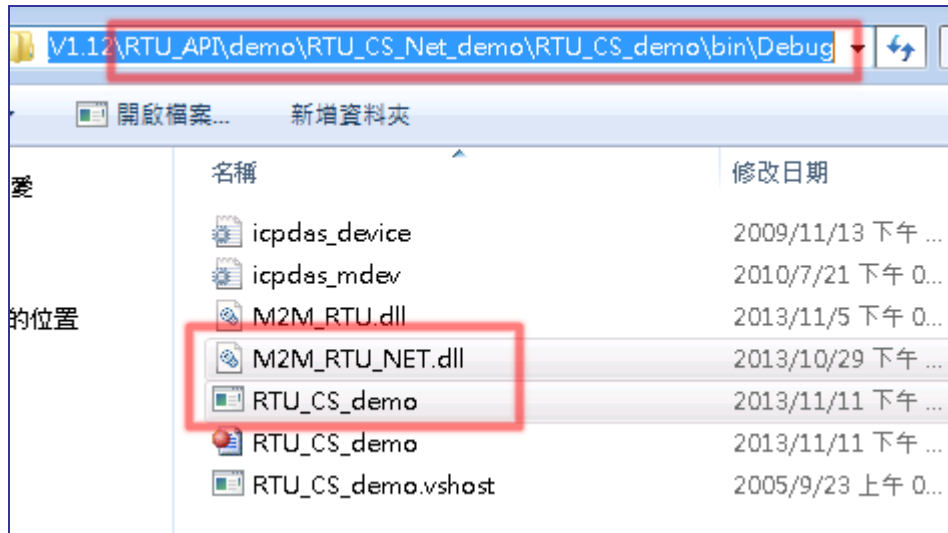

(18) Execute "RTU_CS_Demo.exe".

- Press "Get Information" to get all stations information.
- Set "Station ID" as 1 (because we set Station ID as 1 in GRP device)
- Press "(2)ReadData" button to read Local IO data. Because GRP device don't have local IO, we get the error code here
- Set "Modbus ID" as 1 and "Modbus Name" as "ET-7050", and press "(3)ReadData" to get all IO data.
- Press "Write Dos (add 1)" button to control DO.

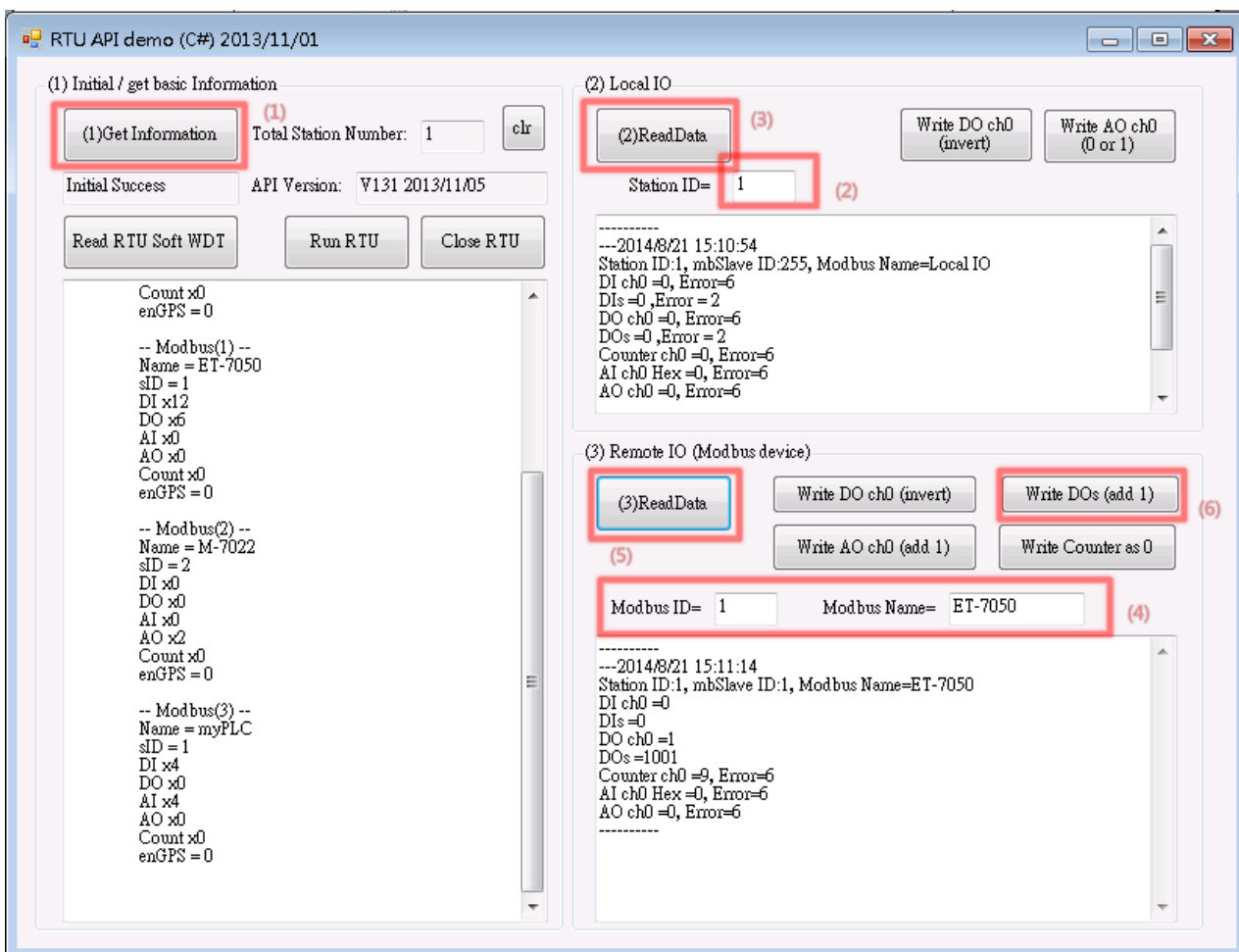

4.6 RTU Client for Remote Control Application with OPC DA Server.

- (1) Please refer last section for setting of “RTU Client”, “RTU Center”.
- (2) After install “NAPOPC.M2M DA Server”, please click the icon to launch NAPOPC.M2M DA Server from right-bottom toolbar of desktop.

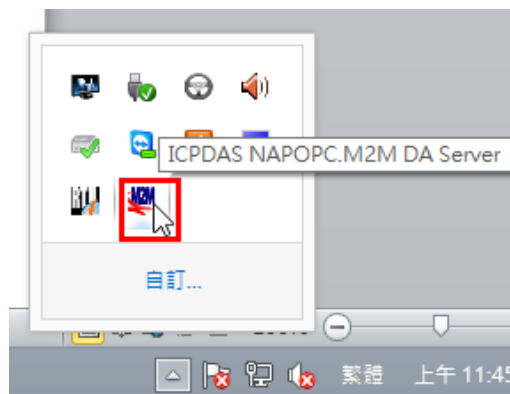

- (3) Click “Search” to add all tags of GRP device automatically.

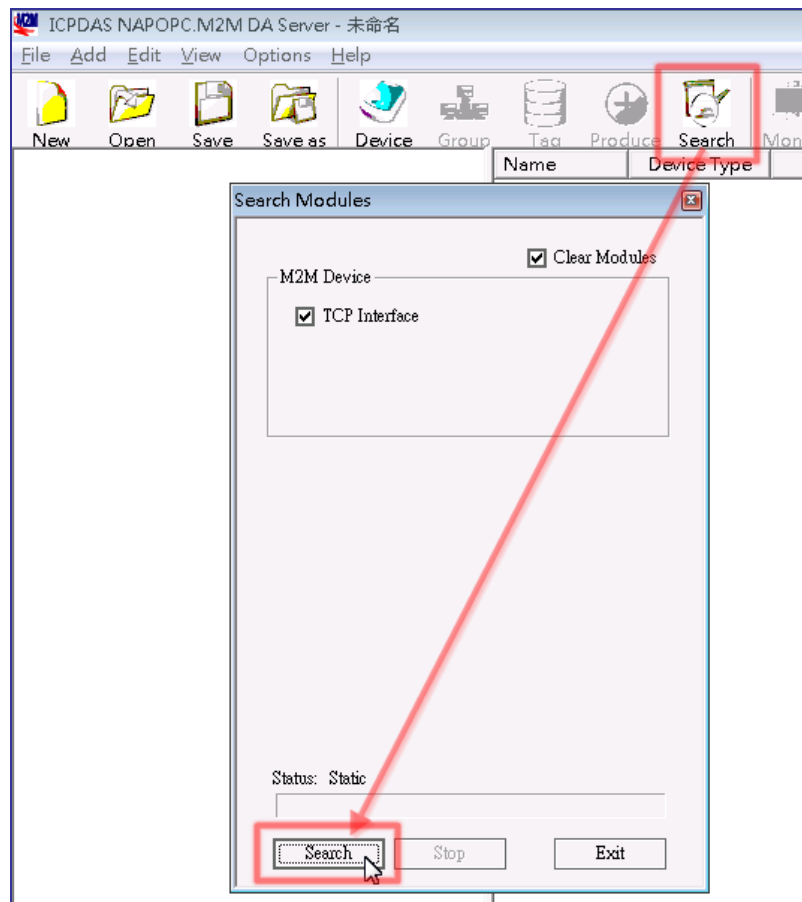

(4) You will get a tag list as below.

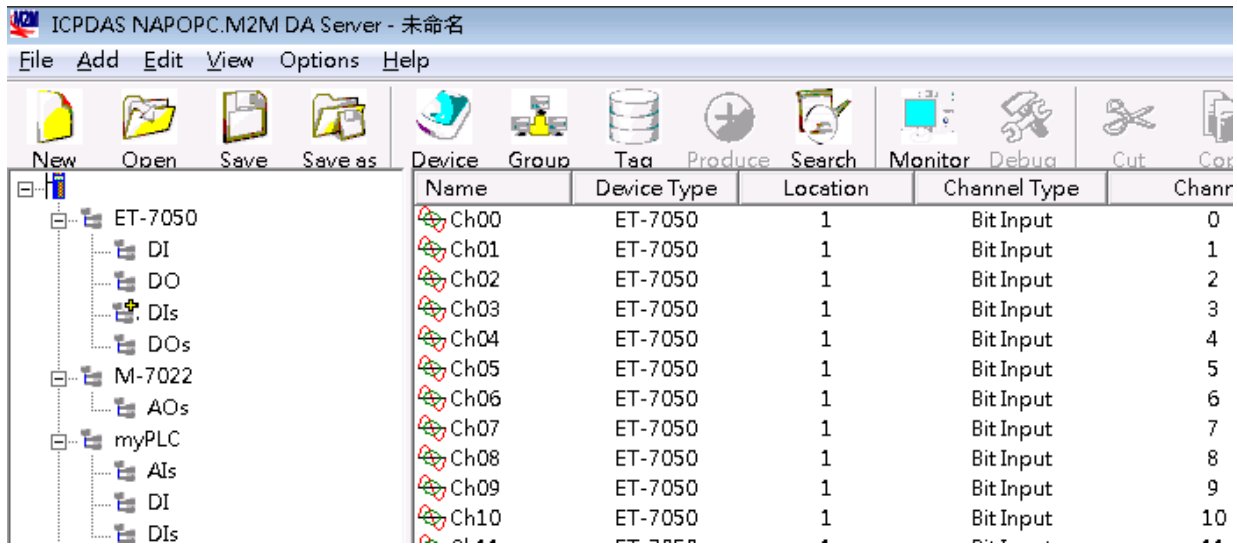

(5) You can double click on device node to modify device name.

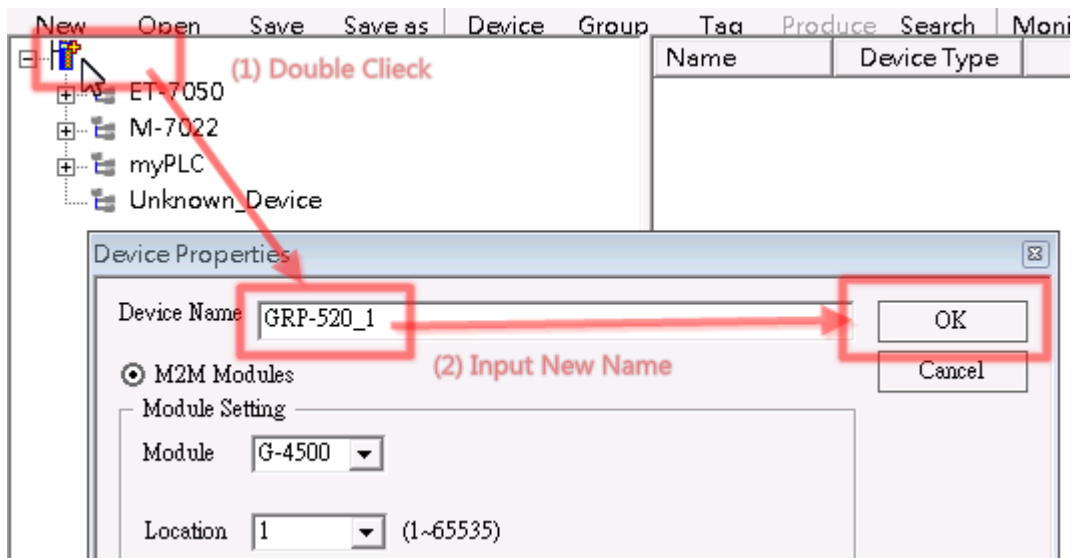

(6) Now you can use OPC Client to read I/O data from NAPOPC.M2M DA Server.
Or you can client "Monitor" to monitor all I/O data.

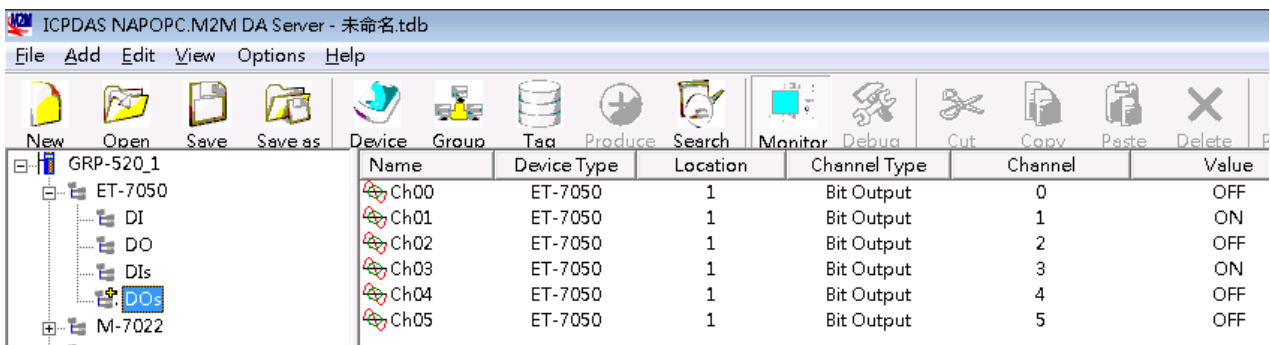

4.7 RTU Client for Remote Control Application with InduSoft.

This example shows how to using SCADA “InduSoft” to control/monitor remote I/O with GRP device.



- (1) About RTU Client, RTU Center and OPC Server, please refer last section.
- (2) Right-click OPC DA 2.05 folder and insert a new worksheet.

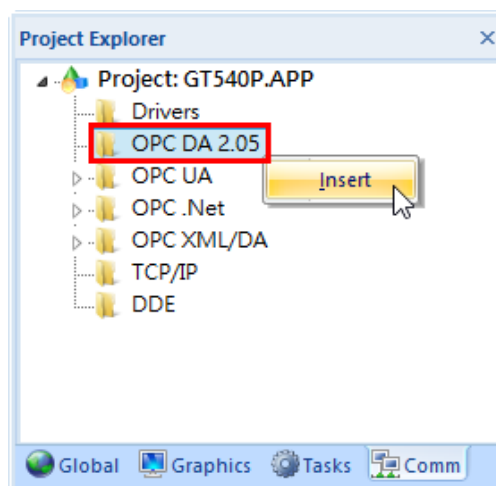

(3) Choice OPC Server from Server Identifier, and Select NAPOPC.M2M Item from combo box.

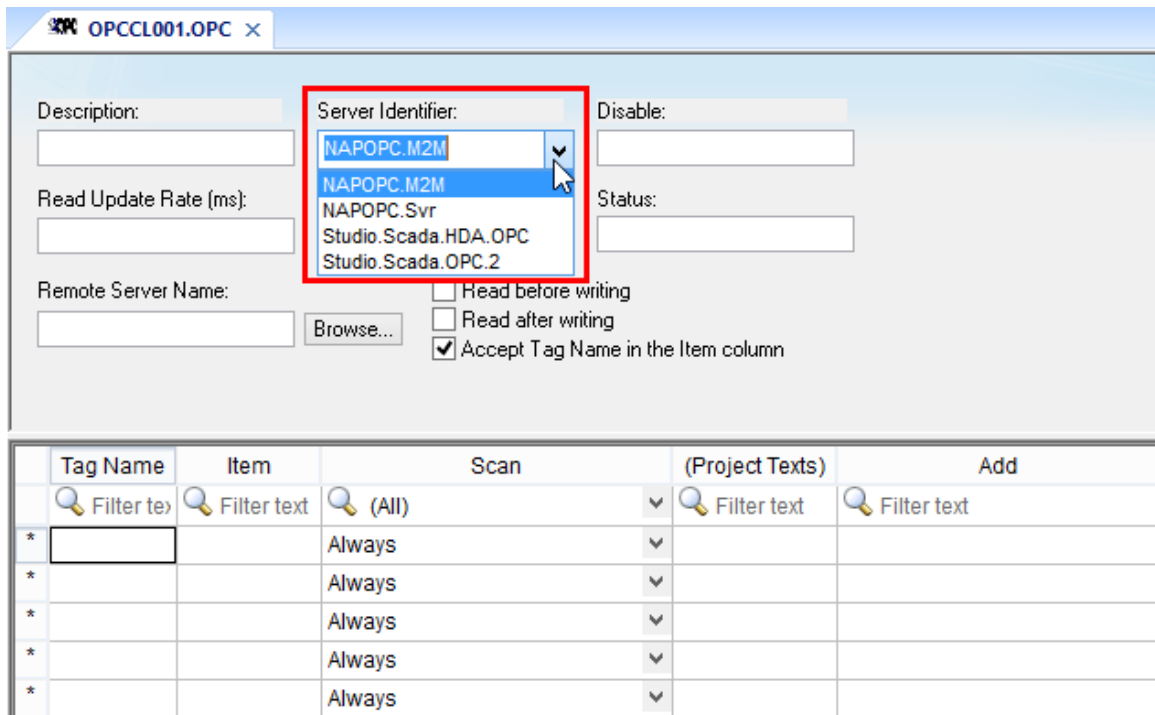

(4) Configure Tag Name and Item Column

- Fill in your tag.
- Double-click Item column and select the point from pop-up window.

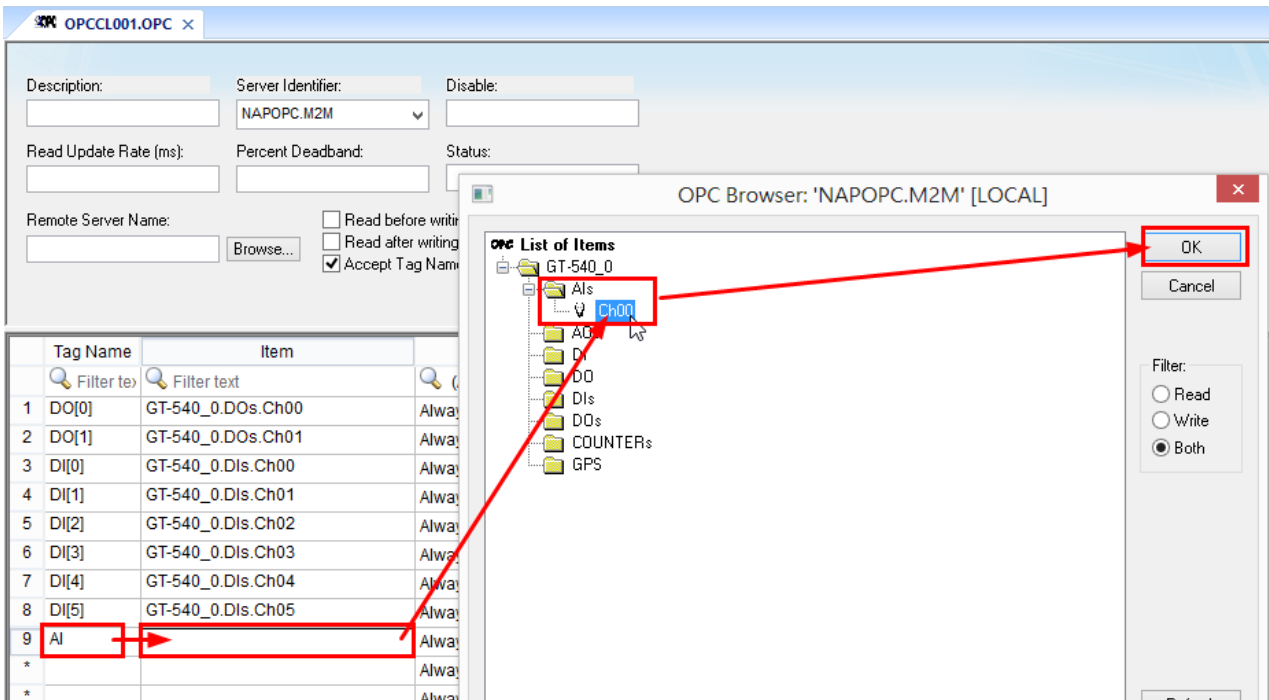

4.8 Email or FTP report I/O logger file.

This example shows how to using GRP device to report I/O logger file periodically.



- (1) About Modbus configure, please refer section 4.5.
- (2) Configure Email / FTP function in “Email/FTP” Tab. You must set “Data Log Interval” field more than 0, or log report function will be disabled. (include FTP and Email)
 - Configure “Data Log Interval” to record IO data into csv file. (0 → disable)
filename format: GRP-530_StationID_YYYYMMDD_hhmmss.csv
ex: GRP-530_13_20140806_172347.csv
 - Configure “Max. Time per Log File” to indicate how long to change / send back log file. If the file size is close 3MB, GRP device will create a new log file to recode I/O data and move old log file into “/RTU/LOGFILE/” in SD card.
 - If you need FTP report function, please set all FTP parameters and set “Enable FTP Function” as “Enable”. GRP device will send log file to FTP Sever when new log file is available.
 - If you need Email report function, please set all Email parameters and set “Enable FTP Function” as “Enable”. If you need 2 or more contact, please use comma “,” to separate each contact.

Main Info.	Modbus Device	FTP / Email
Data Log Interval (sec.)	5	0~86400 (0=disable)
Max. Time per Log File (min.)	3	3~1440 minutes
FTP Server Address	<input type="text" value=""/>	empty --> disable FTP
FTP Port	221	default=21
FTP Username	test	
FTP Password	test	
Enable FTP Funcion	<input checked="" type="checkbox"/> Enable	
Email From	<input type="text" value="abc@gmail.com"/> Ex: abc@gmail.com	empty --> disable Email
Email To	<input type="text" value="xyz@gmail.com"/> Ex: xyz@gmail.com	
Example for 2 or more contact	<input type="text" value="xx@gmail.com,yy@gmail.com"/>	
Email Server	<input type="text" value="smtp.gmail.com"/> Ex: smtp.gmail.com	
Email Server Port	<input type="text" value="25"/> Ex: 25	
Email Username	<input type="text" value="abc"/> Ex: abc	
Email Password	<input type="text" value="123abc"/> Ex: 123abc	
Enable Email Funcion	<input type="checkbox"/> Enable	
<input type="button" value="Modify"/>		

- (3) Finally, please don't forget enable firmware in "Main Info." Tab. If you don't need the firmware send data to RTU Center, you can set "Data Update Period" as 0.

Main Info.	Modbus Device	FTP / Email
Server Address	<input type="text" value="192.168.1.1"/>	
Server Port	<input type="text" value="10000"/>	default=10000
Station ID	<input type="text" value="1"/>	1~65535
Data Update Period(sec.)	<input type="text" value="0"/>	0~86400 (0=disable)
Heartbeat Period(sec.)	<input type="text" value="0"/>	1~86400 (a day)
<hr/>		
Baud Rate (RS-485 for Modbus/RTU)	9600 ▼ bps	
Data Bit	8 ▼	
Parity	N ▼	
Stop Bit	1 ▼	
Modbus Timeout (ms)	<input type="text" value="1000"/>	50~99999, default=1000
<hr/>		
Enable Firmware	<input checked="" type="checkbox"/> Enable	
Alive	True	
<input type="button" value="Modify"/>		

Appendix A. Revision History

This chapter provides revision history information to this document.

The table below shows the revision history.

Version	Date	Description of changes
1.0.0	2015-11-05	The First Release Revision
1.1.1	2016-10-26	New feature: GPS Function
1.1.3	2016-11-21	Add 4G version (GRP-540M-4GE)
1.1.4	2017-01-11	Add DDNS Function New feature: RTU-CAN Function
1.1.5	2017-06-29	Add UDP Search Fucntion Add Default IP mode when booting
1.1.6	2017-09-12	Add Reset Network Function New feature: WLAN Function
1.2.0	2018-03-20	Typesetting revision
1.2.1	2019-02-22	Add information of GRP-541M