

## ULTRAFast RECOVERY POWER RECTIFIER

### Features

- High voltage and high reliability
- Ultrafast reverse recovery time
- High speed switching
- Low power loss and High efficiency
- Halogen-free component and RoHS compliant device

### Applications

- General purpose
- Switching mode power supply
- Free-wheeling diode for motor application
- Power switching circuits
- DC-DC converter systems

### Description

The SF5A400HD is ideally as boost diode in discontinuous or critical mode power factor corrections. The device is also intended for use as a freewheeling diode in power supplies and other power switching applications.

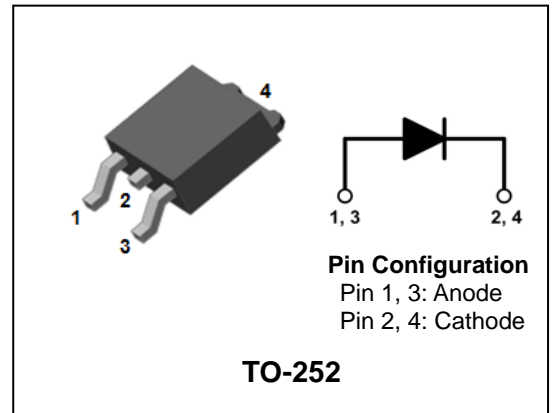

### Product Characteristics

$I_{F(AV)}$	5A
$V_{RRM}$	400V
$V_{FM} @ T_j=125^\circ\text{C}$	1.2V
$t_{rr}$	30ns

### Ordering Information

Device	Marking Code	Package	Packaging
SF5A400HD	SF5A400HD	TO-252	Tape & Reel

### Marking Information

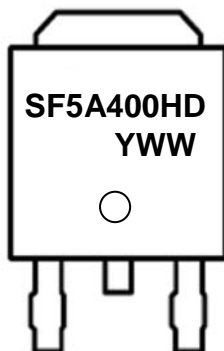

SF5A400HD = Specific Device Code  
 YWW = Year & Week Code Marking  
 -. Y = Year Code  
 -. WW = Week Code

## Absolute Maximum Ratings (Limiting Values)

Characteristic	Symbol	Value	Unit
Maximum repetitive reverse voltage Maximum working peak reverse voltage Maximum DC blocking voltage	$V_{RRM}$ $V_{RWM}$ $V_R$	400	V
Maximum average forward rectified current	$I_{F(AV)}$	5	A
Peak forward surge current 8.3ms single half sine-wave superimposed on rated load per diode	$I_{FSM}$	60	A
Storage temperature range	$T_{stg}$	-45 to +150	°C
Maximum operating junction temperature	$T_J$	150	

## Thermal Characteristics

Characteristic	Symbol	Value	Unit
Maximum thermal resistance junction to case	$R_{th(j-c)}$	6.0	°C/W

## Electrical Characteristics

Characteristic	Symbol	Test Condition	Min.	Typ.	Max.	Unit	
Peak forward voltage drop	$V_{FM}^{(1)}$	$I_{FM} = 5A$	$T_J = 25^\circ C$	-	-	1.40	V
			$T_J = 125^\circ C$	-	-	1.20	
Reverse leakage current	$I_{RM}$	$V_R = V_{RRM}$	$T_J = 25^\circ C$	-	-	20	uA
			$T_J = 125^\circ C$	-	-	200	
Reverse recovery time	$t_{rr}$	$I_F = 1A, di/dt = -100 A/us$	-	-	30	ns	
Junction capacitance	$C_j$	$V_R = 4V_{DC}, f=1MHz$	-	-	100	pF	

**Note :** (1) Pulse test :  $t_p \leq 380us$ , Duty cycle  $\leq 2\%$

## Rating & Electrical Characteristic Curves

**Fig. 1) Typical Forward Characteristics**

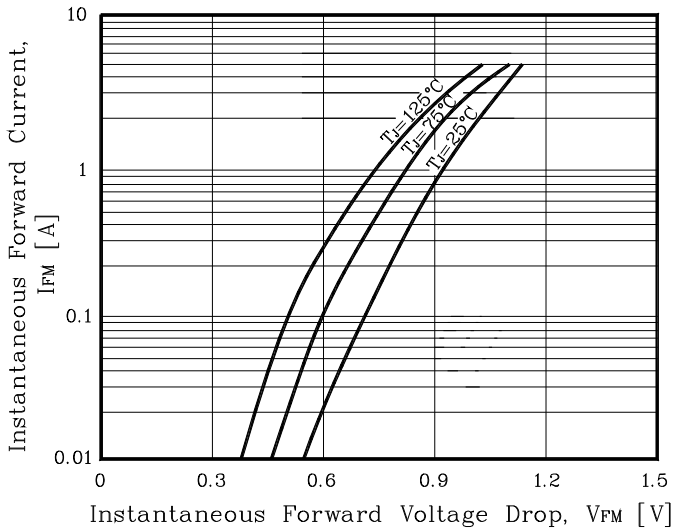

**Fig. 2) Typical Reverse Characteristics**

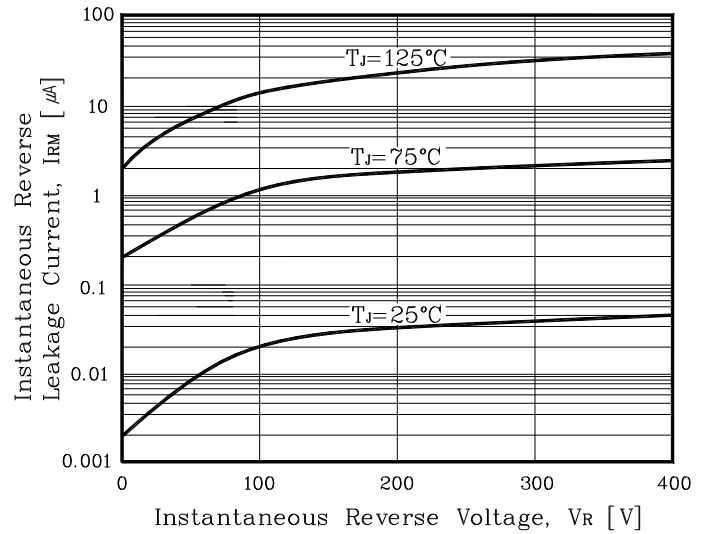

**Fig. 3) Maximum Forward Derivative Curve**

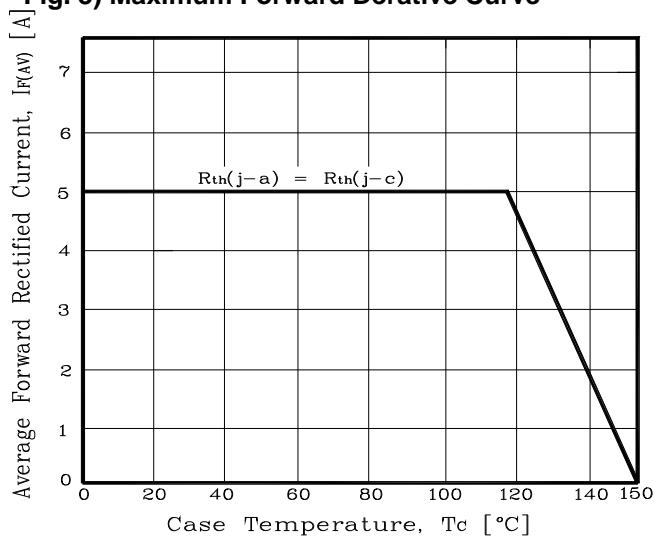

**Fig. 4) Forward Power Dissipation**

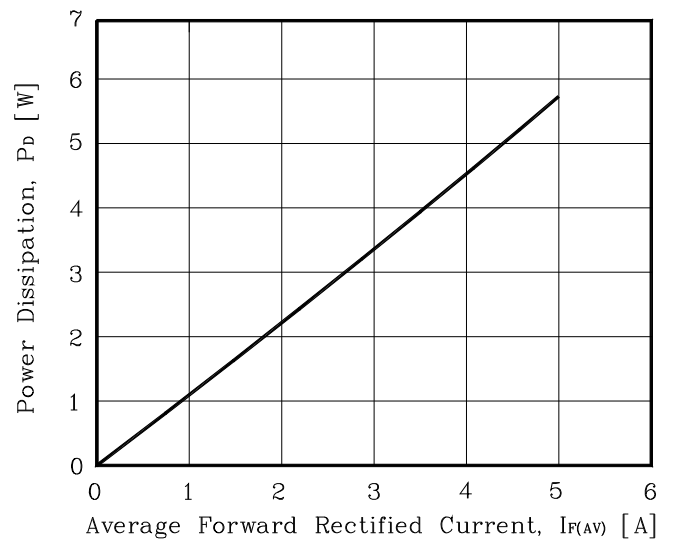

**Fig. 5) Maximum Non-Repetitive Peak Forward Surge Current**

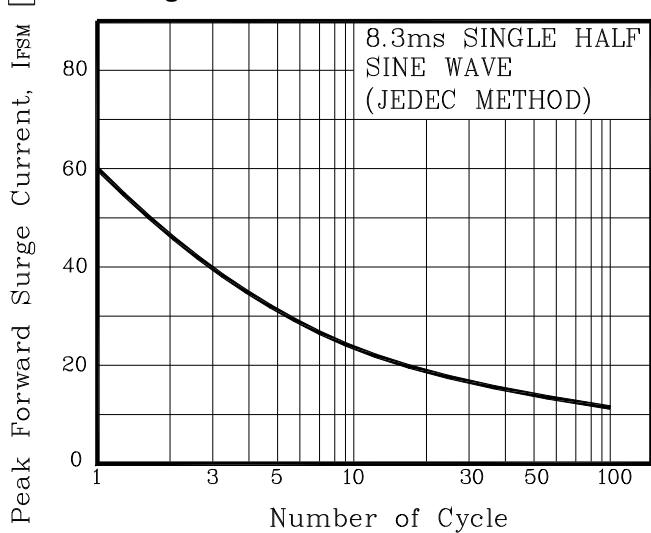

**Fig. 6) Typical Junction Capacitance**

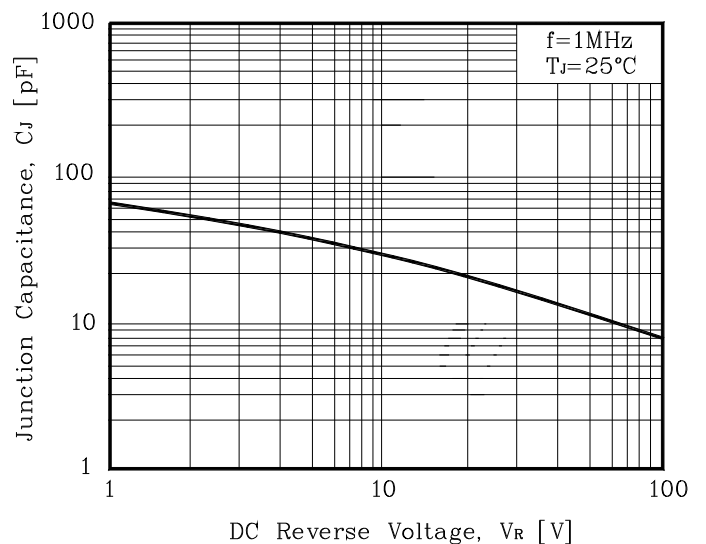

## Package Outline Dimension (Unit: mm)

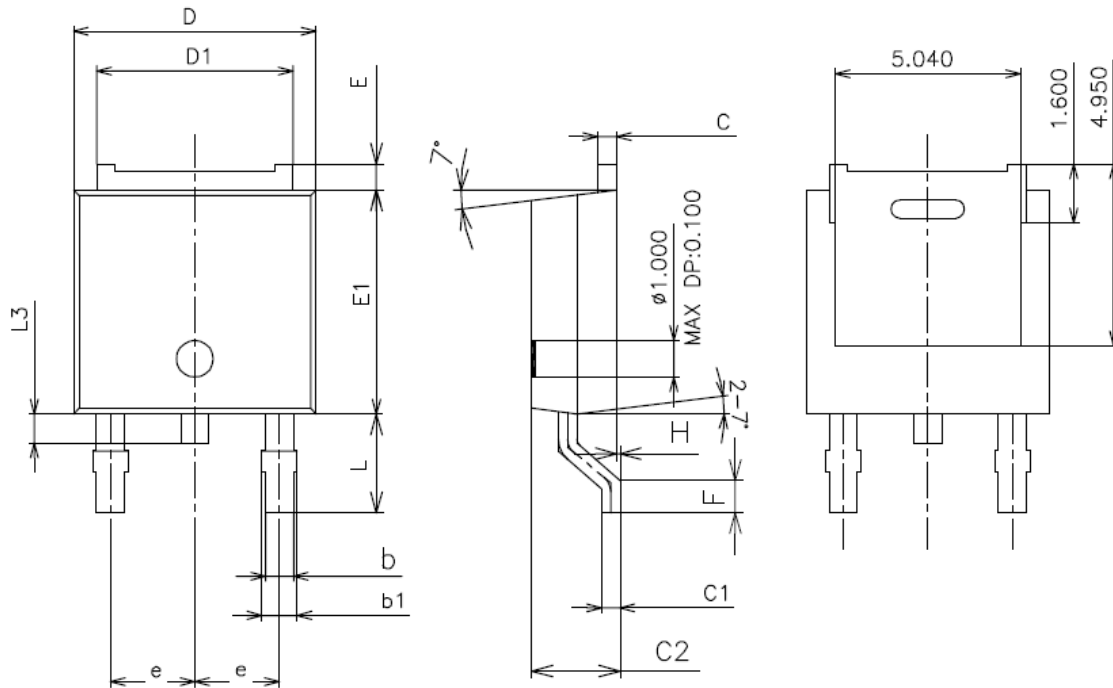

SYMBOL	MILLIMETERS			NOTE
	MINIMUM	NOMINAL	MAXIMUM	
D	6.40	6.60	6.80	
D1	5.14	5.34	5.54	
E	0.50	0.70	0.90	
E1	5.90	6.10	6.30	
A	2.20	2.30	2.40	
A1	0.87	1.07	1.27	
C	0.40	0.50	0.60	
C1	0.40	0.50	0.60	
C2	2.10	2.30	2.50	
L	2.50	2.70	2.90	
L3	0.60	0.80	1.00	
b	0.66	0.76	0.86	
b1	0.96 MAX			
e	2.10	2.30	2.50	
F	0.80 Min			
H	0	-	0.100	

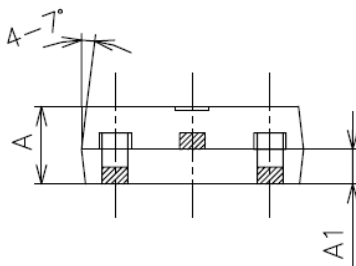

## ※ Recommended Land Pattern (unit: mm)

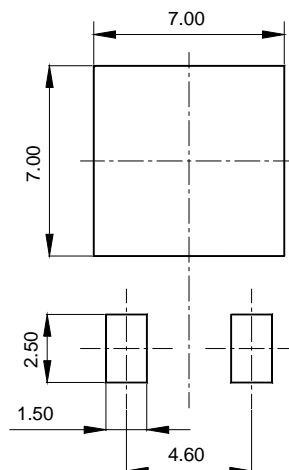

**The AUK Corp. products are intended for the use as components in general electronic equipment (Office and communication equipment, measuring equipment, home appliance, etc.).**

**Please make sure that you consult with us before you use these AUK Corp. products in equipments which require high quality and / or reliability, and in equipments which could have major impact to the welfare of human life(atomic energy control, airplane, spaceship, transportation, combustion control, all types of safety device, etc.). AUK Corp. cannot accept liability to any damage which may occur in case these AUK Corp. products were used in the mentioned equipments without prior consultation with AUK Corp..**

**Specifications mentioned in this publication are subject to change without notice.**