



Attention, Risk of,
Danger, Warning



High Voltage,
Risk of Electric Shock



Double / Reinforced
Insulation



NOT
Litter



CE Mark

TECHNICAL SPECIFICATION



- **Dimensions** : DT109:96x96, DT107:72x72, DT105/DT106:48x96, DT104:48x48mm
- **Panel Cut-out** : DT109:91x91, DT107:68x68, DT105/DT106:93,5x45,5, DT104:45,5x45,5mm
- **Display** : 4 Digits 7 Segment (PV), 4 digits 7 Segment (SV)
- **Sensor Type** : J,K,T,S,R type T/C, Pt100 selectable
- **Measuring Scale** : -100 .. 600 °C, J type T/C, (Inpt=J), -100 .. 1300 °C, K type T/C, (Inpt=K)
-100 .. 400 °C, T type T/C, (Inpt=t), 0 .. 1750 °C, S type T/C, (Inpt=S)
0 .. 1750 °C, R type T/C, (Inpt=r), -100 .. 600 °C, Pt100, (Inpt=Pt)
-99.9 .. 600.0 °C, Pt100, (Inpt=Pt.0)



- **Resolution** : ± 1 °C or ± 0.1 °C
- **Accuracy** : ± 0.3 % (Over full scale)
- **Control Form** : ON-OFF or P, PI, PD, PID - selectable
- **Out Output** : Relay (NO + NC), 250VAC, 2A, Resistive load, (optional SSR)
- **Alarm Output** : Relay (NO + NC), 250VAC, 2A, Resistive load, (only NO for DT104)
- **Heat SET** : Lower Limit .. Upper Limit °C (H.Set)
- **Alarm SET** : AL.tY = Abs,-Abs; Lo.L .. UP.L °C (A.Set)
AL.tY = rel, -rel, bnd, -bnd, bn.i, -bn.i; -100 .. +100 / -10.0 .. +10.0 (Pt.0)



- **Heat Hysteresis** : 0 .. 50 / 0.0 .. 5.0 °C (H.Hys); PID is active if set to 0
- **Alarm Hysteresis** : 1 .. 50 / 0.1 .. 5.0 °C (A.Hys)
- **Proportional Band** : 1 .. 130 °C (Pb.C)
- **Integral Time** : 0 .. 30,0 min. (OFF if set to 0)
- **Derivative Time** : 0.. 10,0 min. (OFF if set to 0)
- **Control Period** : 4 .. 200 sec. (Ct)
- **Offset** : -100..+100 °C / -10.0 .. +10.0 °C (oFFS)
- **Heating/Cooling** : Selectable (only ON-OFF control form is active for cooling)
- **Cold. Junc. Comp.** : 0 .. 50 °C (T/C)



- **Line Comp.** : 10 Ohm max. (3 wire Pt100)
- **Sensor Failure** : ALARM output is always OFF, OUT output is active according to P.Err and Ct parameters in case of sensor failure, measurement out of range or hardware fails to measure input signal (OUT output is OFF if Perr is 0)
- **Supply Voltage** : 100..240VAC, 50-60Hz or 24VDC/AC (isolation voltage: 40VAC max.)



- **Power Consumption** : < 8VA
- **Humidity** : 80% up to 30°C, then linearly decreases to 50% at 50°C (non-condensing)
- **Altitude** : < 2000 m



- **EMC** : EN 61000-6-1, EN 61000-6-3 (Only light industrial environment)
- **Safety** : EN 61010-1; Pollution degree 1, measurement category I, (Only light industrial environment, double/reinforced isolated, non-conductive pollution environment)







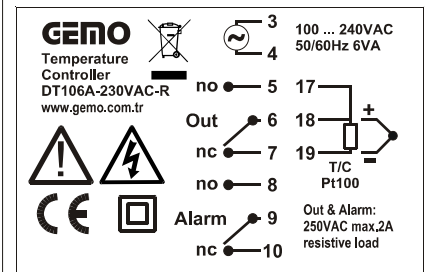
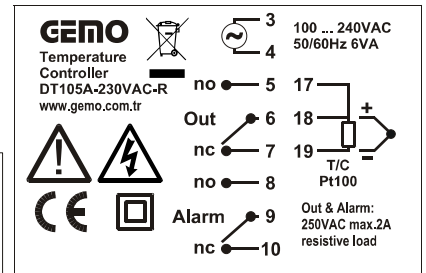
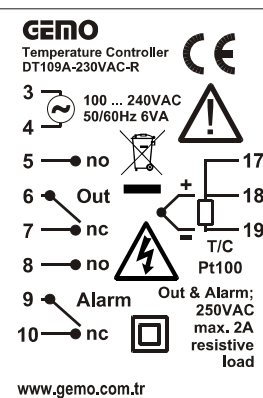
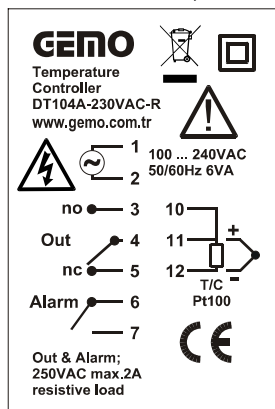
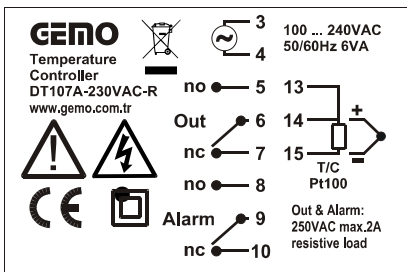

- **Protection Class** : IP20; according to EN 60529
- **Operation Temp.** : 0 .. 50 °C
- **Storage Temperature** : -10°C .. 60°C (no icing)
- **Weight** : < 0.5 kg
- **Torque for screwing** : Max. 0.5 N.m

WARNING: if 2 wire Pt100 is used, connect compensation lead to measuring lead: (DT109 / DT105 / DT106:17-18, DT107: 13-14, DT104: 10-11)

no: normally open
nc: normally closed



INSTALLATION, USE and WARNINGS

-  ● This device and its packing is NOT litter and may NOT be disposed of with domestic waste. Please return this device and its packing to an appropriate recycling point at the end of its service life.
- Please read this user manual carefully and completely before installation and use. Please take into consideration all warnings mentioned in this manual.
-  ● DT109A / DT107A / DT106A / DT105A / DT104A are suitable only for permanent panel type mounting
- Installation and use of this device must be done by qualified, authorized and trained technical personnel only.
- Inspect device carefully before installation. Do not install and use broken and defective devices.
- Do not disassemble device. Do not make any repair on any part of the device. There is no accessible part inside the device. Please contact to manufacturer for broken and defective devices.
-  ● Do not use device in environments subject to flammable, explosive and corrosive gases and/or substances.
- This device is designed for applications only in light industrial environments. This device is not suitable for medical and residential use. This device is not suitable for use related with human health and safety. This device is not suitable for automotive, military and marine use.
- Do not allow children and unauthorized people to use this device.
- Before installation and any technical work, disconnect the power supply and mains connections.
- Check the power supply voltage level before power on, and make sure voltage level is in specified limits. Check quality of neutral line. Improper neutral line may give permanent damage to the device.
-  ● Connect an external power switch and an external fuse (1A, 250VAC) to the power supply line that are easily accessible for rapid intervention. Connect an external fuse (2A, 250VAC) for each relay output separately.
- Use appropriate cables for power supply and mains connections. Apply safety regulations during installation.
- Install the device in a well ventilated place. Install the device permanently into a proper panel cut-out. Fix the device with two fasteners supplied with the device. Only front panel must be accessible after installation is completed.
- Do not operate the device other than the environmental conditions given in Technical Specification.
- Do not operate the device in environments that may cause conductive pollution.
- Take precautions against negative environmental conditions like humidity, vibration, pollution and high/low temperature during installation.
-  ● Use correct compensation cables for T/C sensors. Connect T/C cable directly to the device connectors.
- Keep device, signal cables and communication cables away from circuit breakers, power cables and devices/cables emitting electrical noise. Use shielded and twisted signal and communication cables and connect shield to earth ground on device side. Keep length of signal and communication cables less than 3m.
- In your applications, always use separate and independent mechanical and/or electromechanical devices/apparatus to support DT109A / DT107A / DT106A / DT105A / DT104A to handle emergency cases.
-  ● Use insulated cable end-sleeves at the end of cables screwed to the device connector terminals.
- Maximum torque for screwing; 0.5 N.m.
- Please check www.gemo.com.tr for latest device and documentation updates regularly. All updates and all information are subject to change without notice.

GENERAL SPECIFICATION

- This device is designed for basic temperature control applications only in light industrial environments.
- μ P based, PID temperature controller with OUT and ALARM outputs
- Auto-tuning for PID parameters
- Sensor type: T/C (J,K,T,S,R), Pt100, selectable, multi-input
- Selectable control type: P, PI, PD, PID or ON-OFF
- Automatic "Overshoot" elimination in PID mode
- "Anti-windup"
- Upper and Lower limit for SET and ALARM settings
- Selectable relative, absolute or band alarm
- ON-delay for OUT in cooling mode
- Displays SET and PROCESS values
- Cold-junction compensation for T/C
- Line compensation for Pt100
- Excellent linearity with $^{\circ}$ C/mV and $^{\circ}$ C/Ohm look-up tables
- Input "Offset" feature
- Password protection
- High accuracy
- EEPROM memory to store settings
- Optional SSR output
- Easy connection with plug-in connectors

PROGRAMMING PARAMETERS

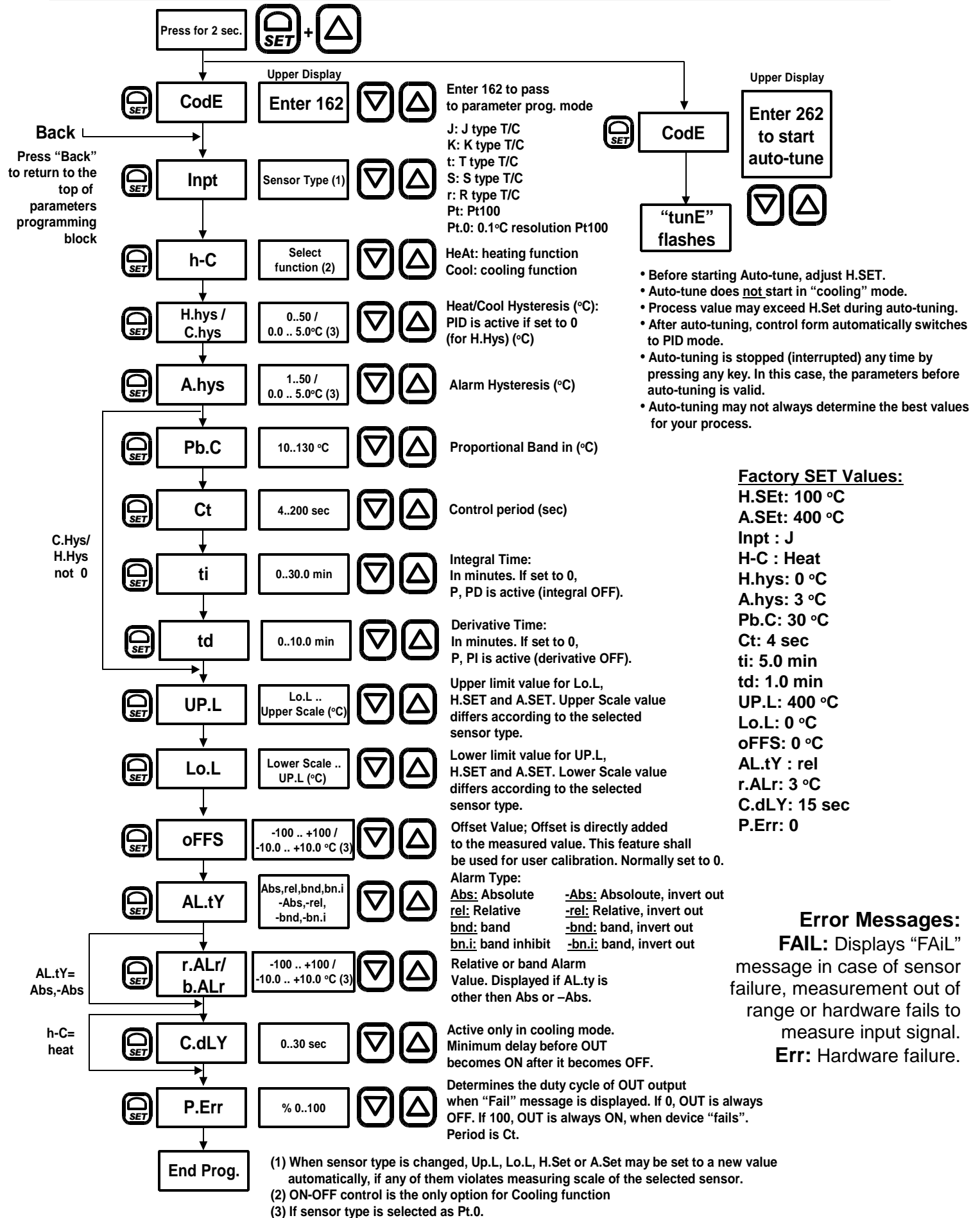

PROGRAMMING HEAT SET and ABSOLUTE ALARM SET

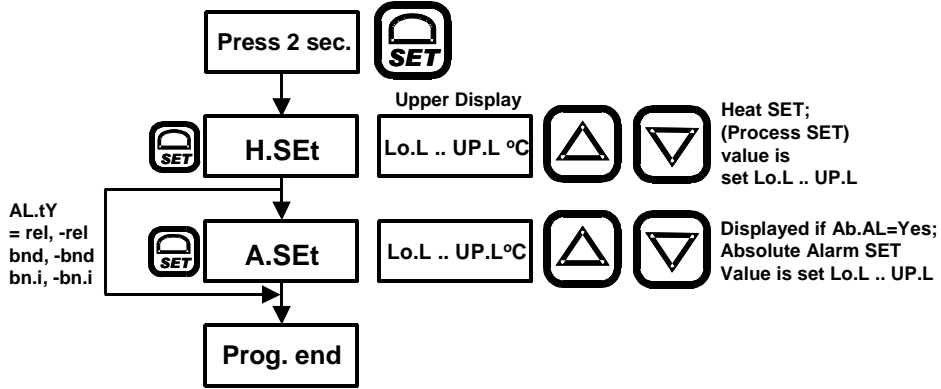

ALARM OUTPUT

AL.tY = Abs, -Abs; X = A.SET
 AL.tY = rel, -rel ; X = H.SET + r.ALr

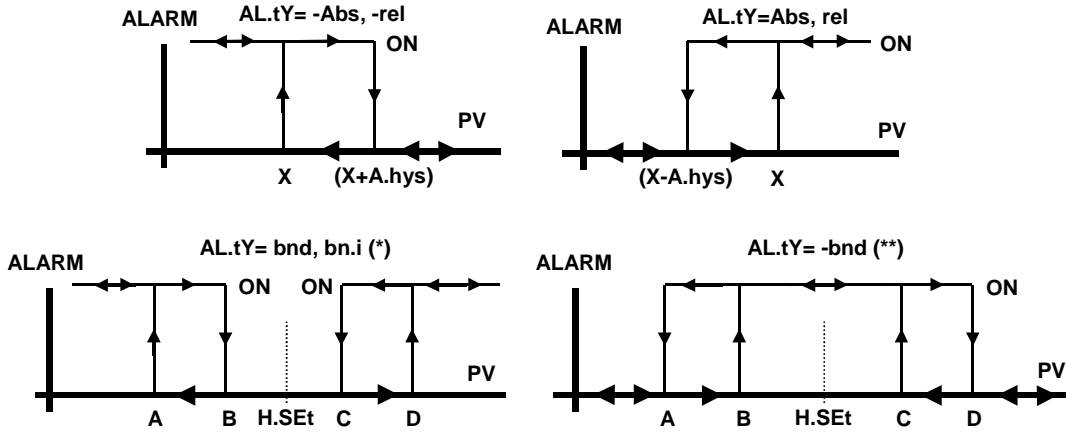

A = H.Set - b.Alr, B = H.SET - b.Alr + A.hys, C = H.SET + b.Alr - A.hys, D = H.SET + b.Alr

(*) AL.tY = bn.i is same as bnd except that if AL.tY = bn.i, ALARM is never ON before PV is in band.
 (**) AL.tY = -bn.i is always same as -bnd.

OUT OUTPUT (ON-OFF CONTROL)

ON-OFF is active when "H.Hys" is other than 0

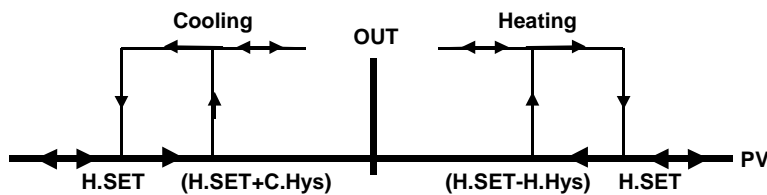

PID PARAMETERS

- **P, PI, PD, PID** is active when "H.Hys" is set to 0 (only for heating; h-C is set to "HEAT")
- **PbC**: Proportional band in °C.
- **Ct**: Control period for PID control. Prefer 4-10 sec.
- **Ti**: Integral time; Set in minutes. Determines how fast controller reacts to compensate the offset between SET point and the process value. If set to 0, integral part is OFF. If set too low, process value may oscillate.
- **Td**: Derivative time; Set in minutes. If set to 0, derivative part is OFF. Determines how sensitive the controller is to changes of the offset between SET point and the process value. If set too high, process value may oscillate or overshoot.

CLAEANING

Do not use any solvents (alcohol, thinners, benzine, acid, etc.) or corrosive substances to clean the device. Use only a dry and clean non-abrasive cloth. Before cleaning, disconnect the power supply and mains connections.

