

DATA SHEET

74F138

1-of-8 decoder/demultiplexer

Product specification

1991 Feb 14

IC15 Data Handbook

1-of-8 decoder/demultiplexer

74F138

FEATURE

- Demultiplexing capability
- Multiple input enable for easy expansion
- Ideal for memory chip select decoding
- Industrial temperature range available (−40°C to +85°C)

DESCRIPTION

The 74F138 decoder accepts three binary weighted inputs (A0, A1, A2) and when enabled, provides eight mutually exclusive, active low outputs (Q0 – Q7). The device features three enable inputs; two active low (E0, E1) and one active high (E2). Every output will be high unless E0 and E1 are low and E2 is high. This multiple enable function allows easy parallel expansion of the device to 1-of-32 (5 lines to 32 lines) decoder with just four 74F138s and one inverter (see Figure 1). The device can be used as an eight output demultiplexer by using one of the active low enable inputs as the data input and the remaining enable inputs as strobes. Enable inputs not used must be permanently tied to their appropriate active high or active low state.

PIN CONFIGURATION

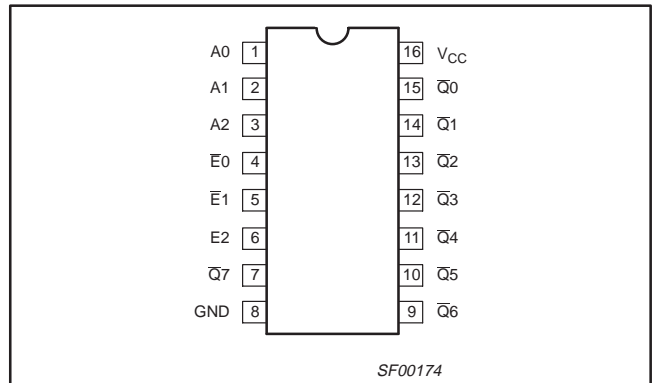

TYPE	TYPICAL PROPAGATION DELAY	TYPICAL SUPPLY CURRENT (TOTAL)
74F138	5.8ns	13mA

ORDERING INFORMATION

DESCRIPTION	ORDER CODE		PKG DWG #
	COMMERCIAL RANGE V _{CC} = 5V ±10%, T _{amb} = 0°C to +70°C	INDUSTRIAL RANGE V _{CC} = 5V ±10%, T _{amb} = −40°C to +85°C	
16-pin plastic DIP	N74F138N	I74F138N	SOT38-4
16-pin plastic SO	N74F138D	I74F138D	SOT109-1

INPUT AND OUTPUT LOADING AND FAN-OUT TABLE

PINS	DESCRIPTION	74F (U.L.) HIGH/LOW	LOAD VALUE HIGH/LOW
A0 – A2	Address inputs	1.0/1.0	20µA/0.6mA
E0, E1	Enable inputs (active Low)	1.0/1.0	20µA/0.6mA
E2	Enable input (active High)	1.0/1.0	20µA/0.6mA
Q0 – Q7	Data outputs	50/33	1.0mA/20mA

NOTE:

One (1.0) FAST unit load is defined as: 20µA in the High state and 0.6mA in the Low state.

LOGIC SYMBOL

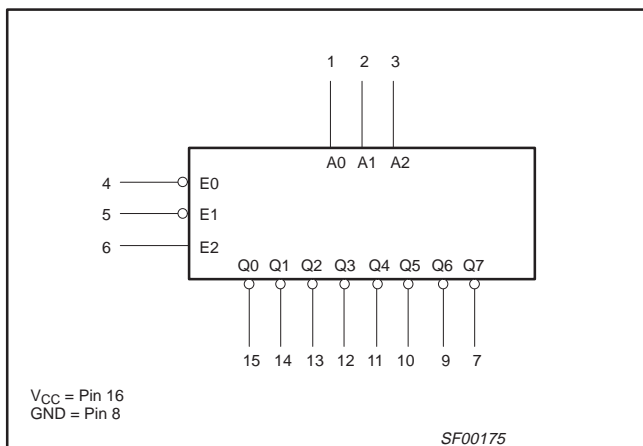

IEC/IEEE SYMBOL

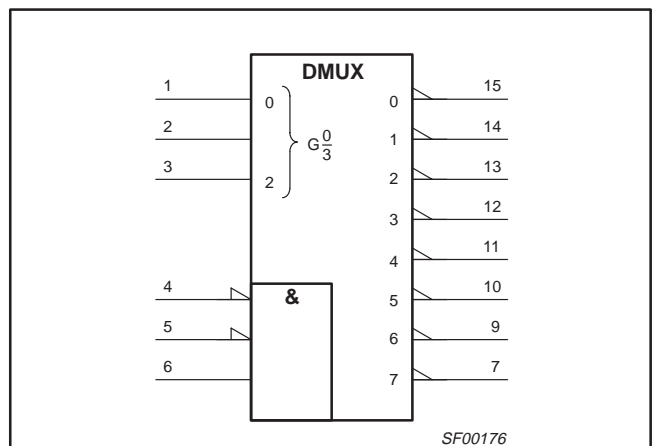

1-of-8 decoder/demultiplexer

74F138

LOGIC DIAGRAM

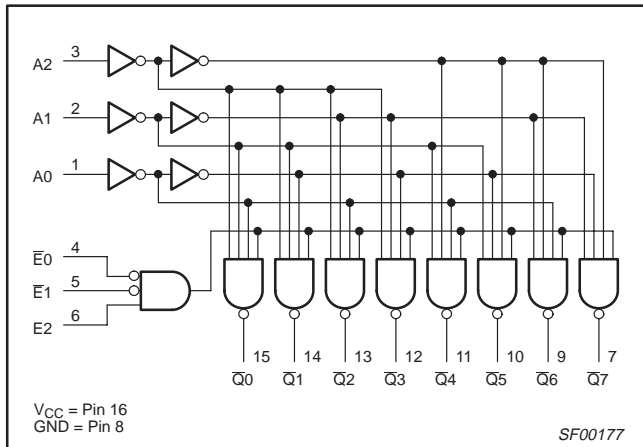

FUNCTION TABLE

INPUTS						OUTPUTS							
E0	E1	E2	A0	A1	A2	Q0	Q1	Q2	Q3	Q4	Q5	Q6	Q7
H	X	X	X	X	X	H	H	H	H	H	H	H	H
X	H	X	X	X	X	H	H	H	H	H	H	H	H
X	X	L	X	X	X	H	H	H	H	H	H	H	H
L	L	H	L	L	L	L	H	H	H	H	H	H	H
L	L	H	H	L	L	H	L	H	H	H	H	H	H
L	L	H	L	H	L	H	H	L	H	H	H	H	H
L	L	H	H	H	L	H	H	H	L	H	H	H	H
L	L	H	L	L	H	H	H	H	H	L	H	H	H
L	L	H	H	L	H	H	H	H	H	H	L	H	H
L	L	H	L	H	H	H	H	H	H	H	H	L	H
L	L	H	H	H	H	H	H	H	H	H	H	H	L

NOTES:

- H = High voltage level
- L = Low voltage level
- X = Don't care

APPLICATION

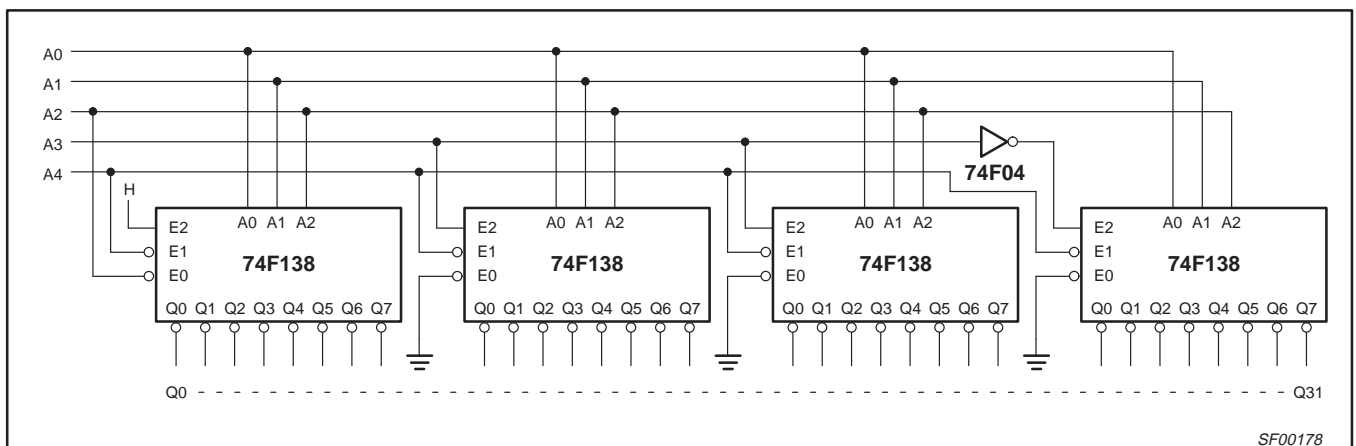

Figure 1. Expansion of 1-of-8 Decoding

1-of-8 decoder/demultiplexer

74F138

ABSOLUTE MAXIMUM RATINGS

(Operation beyond the limit set forth in this table may impair the useful life of the device.
Unless otherwise noted these limits are over the operating free air temperature range.)

SYMBOL	PARAMETER		RATING	UNIT
V_{CC}	Supply voltage		-0.5 to +7.0	V
V_{IN}	Input voltage		-0.5 to +7.0	V
I_{IN}	Input current		-30 to +5	mA
V_{OUT}	Voltage applied to output in High output state		-0.5 to V_{CC}	V
I_{OUT}	Current applied to output in Low output state		40	mA
T_{amb}	Operating free-air temperature range	Commercial range	0 to +70	°C
		Industrial range	-40 to +85	°C
T_{stg}	Storage temperature range		-65 to +150	°C

RECOMMENDED OPERATING CONDITIONS

SYMBOL	PARAMETER	LIMITS			UNIT
		MIN	NOM	MAX	
V_{CC}	Supply voltage	4.5	5.0	5.5	V
V_{IH}	High-level input voltage	2.0			V
V_{IL}	Low-level input voltage			0.8	V
I_{IK}	Input clamp current			-18	mA
I_{OH}	High-level output current			-1	mA
I_{OL}	Low-level output current			20	mA
T_{amb}	Operating free-air temperature range	Commercial range	0	+70	°C
		Industrial range	-40	+85	°C

DC ELECTRICAL CHARACTERISTICS

(Over recommended operating free-air temperature range unless otherwise noted.)

SYMBOL	PARAMETER	TEST CONDITIONS ¹		LIMITS			UNIT
				MIN	TYP ²	MAX	
V_{OH}	High-level output voltage	$V_{CC} = \text{MIN}, V_{IL} = \text{MAX}, V_{IH} = \text{MIN}$	$I_{OH} = \text{MAX}$	$\pm 10\%V_{CC}$	2.5		V
				$\pm 5\%V_{CC}$	2.7	3.4	V
V_{OL}	Low-level output voltage	$V_{CC} = \text{MIN}, V_{IL} = \text{MAX}, V_{IH} = \text{MIN}$	$I_{OL} = \text{MAX}$	$\pm 10\%V_{CC}$		0.30	0.50
				$\pm 5\%V_{CC}$		0.30	0.50
V_{IK}	Input clamp voltage	$V_{CC} = \text{MIN}, I_I = I_{IK}$			-0.73	-1.2	V
I_I	Input current at maximum input voltage	$V_{CC} = \text{MAX}, V_I = 7.0\text{V}$				100	μA
I_{IH}	High-level input current	$V_{CC} = \text{MAX}, V_I = 2.7\text{V}$				20	μA
I_{IL}	Low-level input current	$V_{CC} = \text{MAX}, V_I = 0.5\text{V}$				-0.6	mA
I_{OS}	Short-circuit output current ³	$V_{CC} = \text{MAX}$		-60		-150	mA
I_{CC}	Supply current ⁴ (total)	$V_{CC} = \text{MAX}$			13	20	mA

NOTES:

- For conditions shown as MIN or MAX, use the appropriate value specified under recommended operating conditions for the applicable type.
- All typical values are at $V_{CC} = 5\text{V}$, $T_{amb} = 25^\circ\text{C}$.
- Not more than one output should be shorted at a time. For testing I_{OS} , the use of high-speed test apparatus and/or sample-and-hold techniques are preferable in order to minimize internal heating and more accurately reflect operational values. Otherwise, prolonged shorting of a high output may raise the chip temperature well above normal and thereby cause invalid readings in other parameter tests. In any sequence of parameter tests, I_{OS} tests should be performed last.
- Measure I_{CC} . outputs must be open, V_{IN} on all inputs = 4.5V.

1-of-8 decoder/demultiplexer

74F138

AC ELECTRICAL CHARACTERISTICS

SYMBOL	PARAMETER	TEST CONDITION	LIMITS						UNIT	
			$V_{CC} = +5.0V$ $T_{amb} = +25^{\circ}C$ $C_L = 50pF$ $R_L = 500\Omega$			$V_{CC} = +5.0V \pm 10\%$ $T_{amb} = 0^{\circ}C \text{ to } +70^{\circ}C$ $C_L = 50pF$ $R_L = 500\Omega$		$V_{CC} = +5.0V \pm 10\%$ $T_{amb} = -40^{\circ}C \text{ to } +85^{\circ}C$ $C_L = 50pF$ $R_L = 500\Omega$		
			MIN	TYP	MAX	MIN	MAX	MIN		MAX
t_{PLH} t_{PHL}	Propagation delay An to \bar{Q}_n	Waveform 1, 2	3.5 4.0	5.6 6.1	7.0 8.0	3.5 4.0	8.0 9.0	3.0 3.5	8.5 9.0	ns
t_{PLH} t_{PHL}	Propagation delay $\bar{E}0$ or $\bar{E}1$ to \bar{Q}_n	Waveform 2	3.5 3.0	6.4 5.3	7.0 7.0	3.5 3.0	8.0 7.5	3.0 3.0	8.0 7.5	ns
t_{PLH} t_{PHL}	Propagation delay E2 to \bar{Q}_n	Waveform 1	4.0 3.5	6.2 5.6	8.0 7.5	4.0 3.5	9.0 8.5	4.0 3.5	9.5 8.5	ns

AC WAVEFORMS

For all waveforms, $V_M = 1.5V$

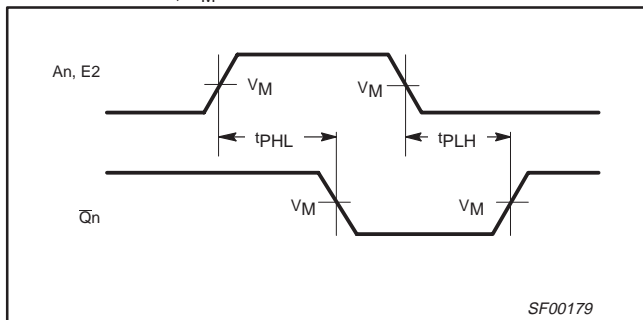

Waveform 1. Propagation Delay for Inverting Outputs

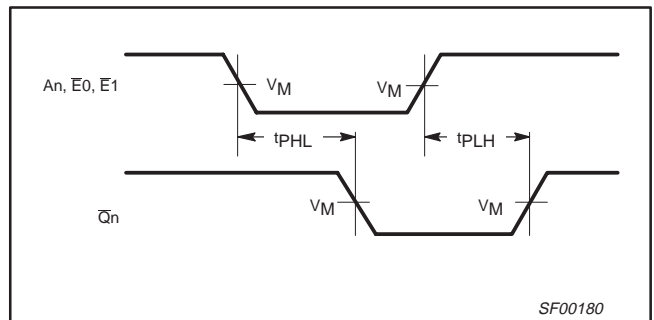

Waveform 2. Propagation Delay for Non-Inverting Outputs

TEST CIRCUIT AND WAVEFORMS

Test Circuit for Totem-Pole Outputs

Input Pulse Definition

DEFINITIONS:

- R_L = Load resistor;
see AC ELECTRICAL CHARACTERISTICS for value.
- C_L = Load capacitance includes jig and probe capacitance;
see AC ELECTRICAL CHARACTERISTICS for value.
- R_T = Termination resistance should be equal to Z_{OUT} of pulse generators.

family	INPUT PULSE REQUIREMENTS					
	amplitude	V_M	rep. rate	t_w	t_{TLH}	t_{THL}
74F	3.0V	1.5V	1MHz	500ns	2.5ns	2.5ns

SF00006

1-of-8 decoder/demultiplexer

74F138

DIP16: plastic dual in-line package; 16 leads (300 mil)

SOT38-4

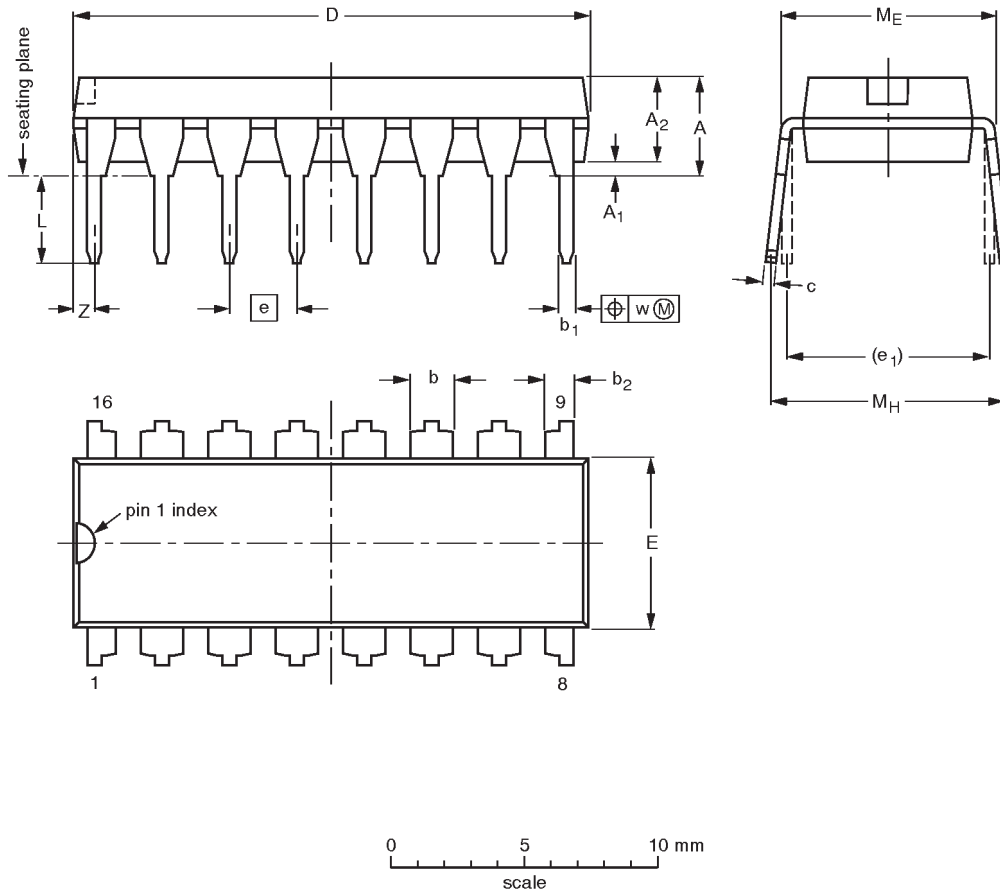

DIMENSIONS (inch dimensions are derived from the original mm dimensions)

UNIT	A max.	A ₁ min.	A ₂ max.	b	b ₁	b ₂	c	D ⁽¹⁾	E ⁽¹⁾	e	e ₁	L	M _E	M _H	w	Z ⁽¹⁾ max.
mm	4.2	0.51	3.2	1.73 1.30	0.53 0.38	1.25 0.85	0.36 0.23	19.50 18.55	6.48 6.20	2.54	7.62	3.60 3.05	8.25 7.80	10.0 8.3	0.254	0.76
inches	0.17	0.020	0.13	0.068 0.051	0.021 0.015	0.049 0.033	0.014 0.009	0.77 0.73	0.26 0.24	0.10	0.30	0.14 0.12	0.32 0.31	0.39 0.33	0.01	0.030

Note

1. Plastic or metal protrusions of 0.25 mm maximum per side are not included.

OUTLINE VERSION	REFERENCES				EUROPEAN PROJECTION	ISSUE DATE
	IEC	JEDEC	EIAJ			
SOT38-4						92-11-17 95-01-14

1-of-8 decoder/demultiplexer

74F138

SO16: plastic small outline package; 16 leads; body width 3.9 mm

SOT109-1

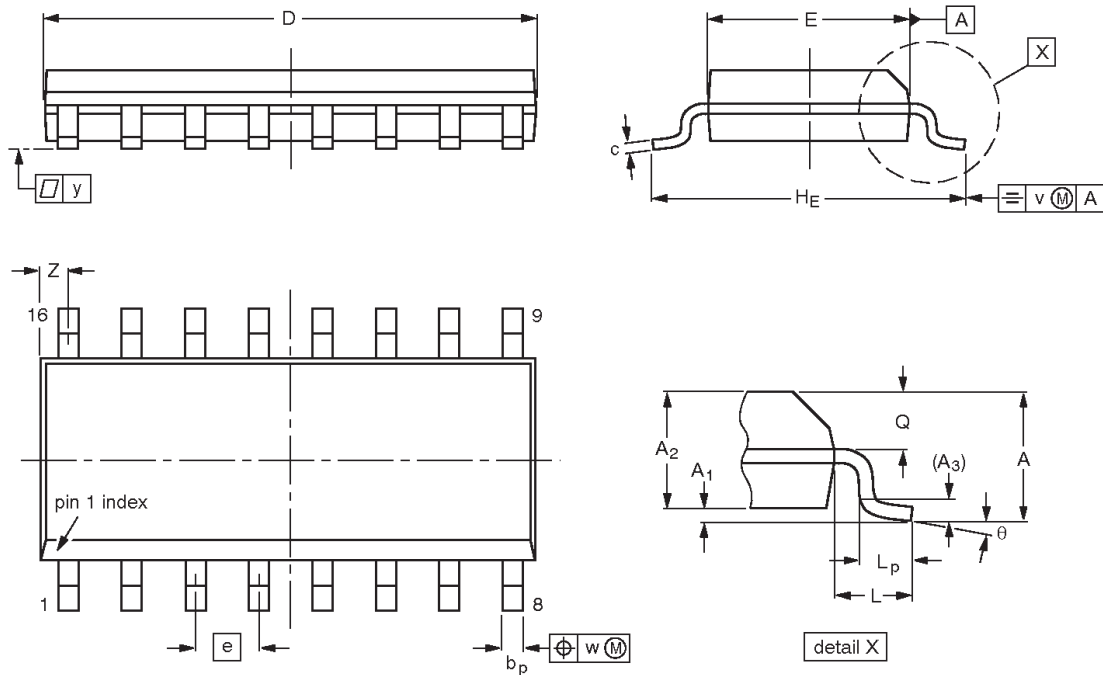

DIMENSIONS (inch dimensions are derived from the original mm dimensions)

UNIT	A max.	A ₁	A ₂	A ₃	b _p	c	D ⁽¹⁾	E ⁽¹⁾	e	H _E	L	L _p	Q	v	w	y	Z ⁽¹⁾	θ
mm	1.75 0.10	0.25 1.25	1.45 0.25	0.25	0.49 0.36	0.25 0.19	10.0 9.8	4.0 3.8	1.27	6.2 5.8	1.05	1.0 0.4	0.7 0.6	0.25	0.25	0.1	0.7 0.3	8° 0°
inches	0.069 0.004	0.010 0.049	0.057 0.01	0.01	0.019 0.014	0.0100 0.0075	0.39 0.38	0.16 0.15	0.050	0.244 0.228	0.041	0.039 0.016	0.028 0.020	0.01	0.01	0.004	0.028 0.012	

Note

1. Plastic or metal protrusions of 0.15 mm maximum per side are not included.

OUTLINE VERSION	REFERENCES				EUROPEAN PROJECTION	ISSUE DATE
	IEC	JEDEC	EIAJ			
SOT109-1	076E07S	MS-012AC				95-01-23 97-05-22

1-of-8 decoder/demultiplexer

74F138

Data sheet status

Data sheet status	Product status	Definition [1]
Objective specification	Development	This data sheet contains the design target or goal specifications for product development. Specification may change in any manner without notice.
Preliminary specification	Qualification	This data sheet contains preliminary data, and supplementary data will be published at a later date. Philips Semiconductors reserves the right to make changes at any time without notice in order to improve design and supply the best possible product.
Product specification	Production	This data sheet contains final specifications. Philips Semiconductors reserves the right to make changes at any time without notice in order to improve design and supply the best possible product.

[1] Please consult the most recently issued datasheet before initiating or completing a design.

Definitions

Short-form specification — The data in a short-form specification is extracted from a full data sheet with the same type number and title. For detailed information see the relevant data sheet or data handbook.

Limiting values definition — Limiting values given are in accordance with the Absolute Maximum Rating System (IEC 134). Stress above one or more of the limiting values may cause permanent damage to the device. These are stress ratings only and operation of the device at these or at any other conditions above those given in the Characteristics sections of the specification is not implied. Exposure to limiting values for extended periods may affect device reliability.

Application information — Applications that are described herein for any of these products are for illustrative purposes only. Philips Semiconductors make no representation or warranty that such applications will be suitable for the specified use without further testing or modification.

Disclaimers

Life support — These products are not designed for use in life support appliances, devices or systems where malfunction of these products can reasonably be expected to result in personal injury. Philips Semiconductors customers using or selling these products for use in such applications do so at their own risk and agree to fully indemnify Philips Semiconductors for any damages resulting from such application.

Right to make changes — Philips Semiconductors reserves the right to make changes, without notice, in the products, including circuits, standard cells, and/or software, described or contained herein in order to improve design and/or performance. Philips Semiconductors assumes no responsibility or liability for the use of any of these products, conveys no license or title under any patent, copyright, or mask work right to these products, and makes no representations or warranties that these products are free from patent, copyright, or mask work right infringement, unless otherwise specified.

Philips Semiconductors
811 East Arques Avenue
P.O. Box 3409
Sunnyvale, California 94088-3409
Telephone 800-234-7381

© Copyright Philips Electronics North America Corporation 1998
All rights reserved. Printed in U.S.A.

print code

Date of release: 10-98

Document order number:

9397-750-05076

Let's make things better.