



ПІЛЯСТРЫ



КАПИТЕЛЬ 1.21.001
СТВОЛ 1.22.010



БАЗА 1.23.100

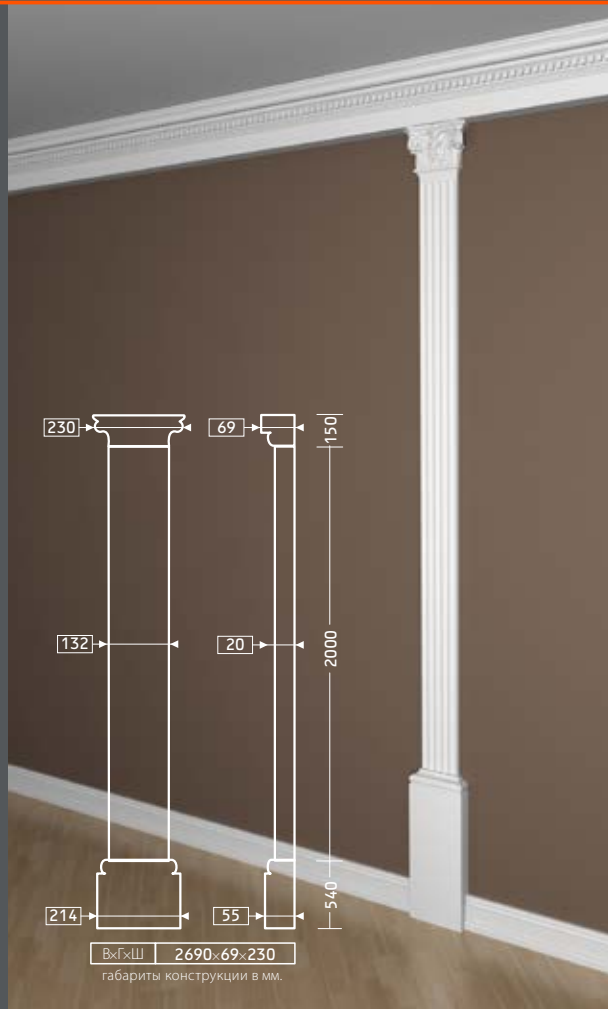
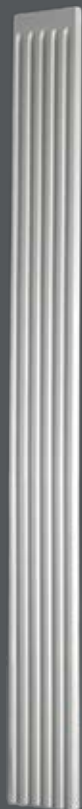

КАПИТЕЛЬ 1.21.002
СТВОЛ 1.22.020



БАЗА 1.23.200

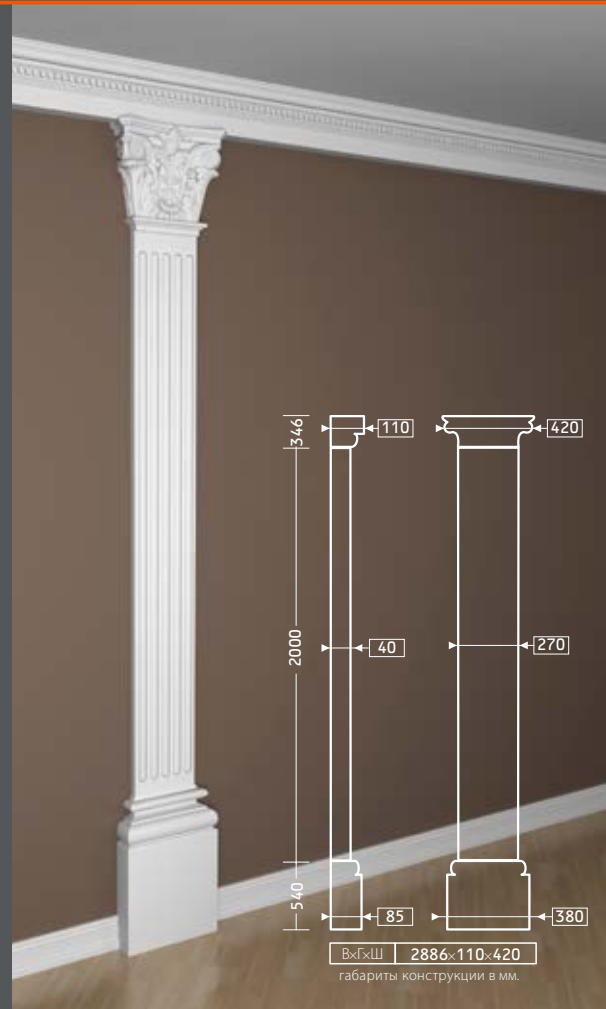

КАПИТЕЛЬ
4.21.301

СТВОЛ
4.22.301

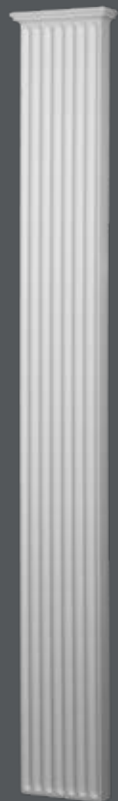

БАЗА
4.23.301

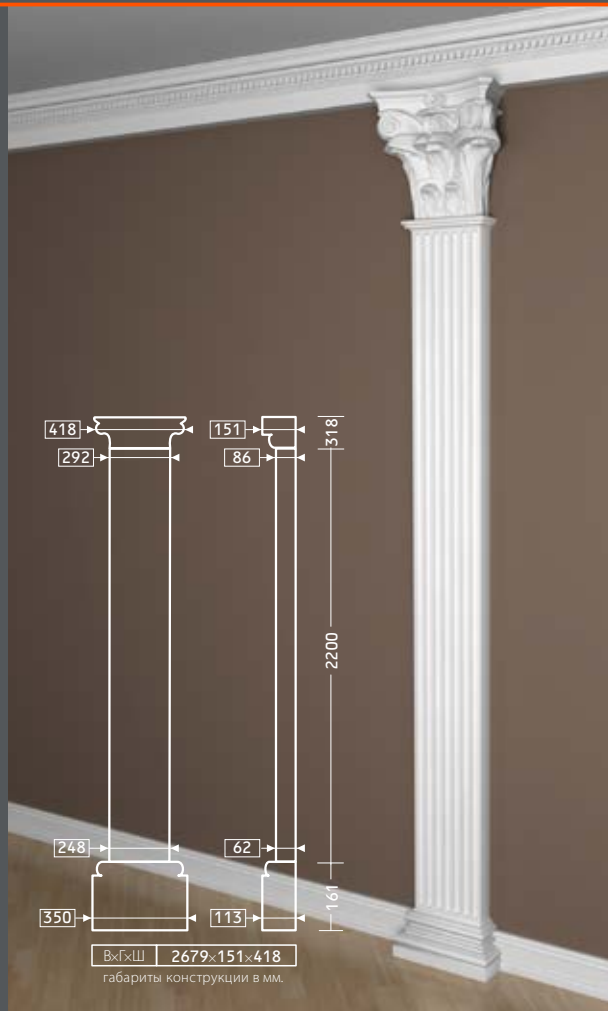
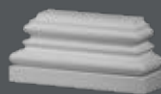

КАПИТЕЛЬ
4.21.301

СТВОЛ
4.22.302



БАЗА
4.23.301

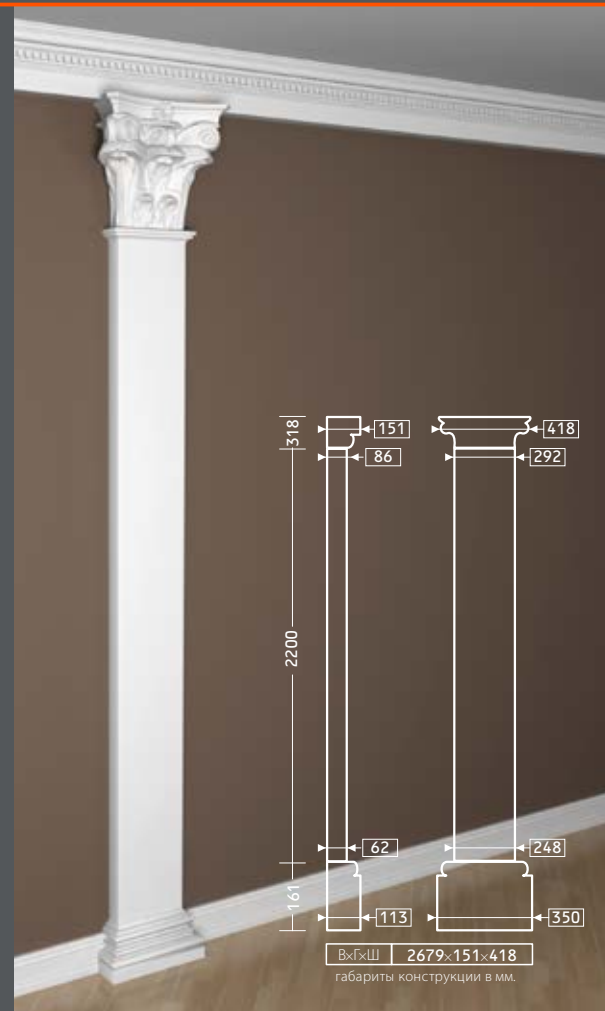
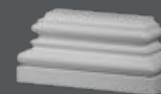

КАПИТЕЛЬ
1.21.002



СТВОЛ
1.22.200



БАЗА
1.23.200

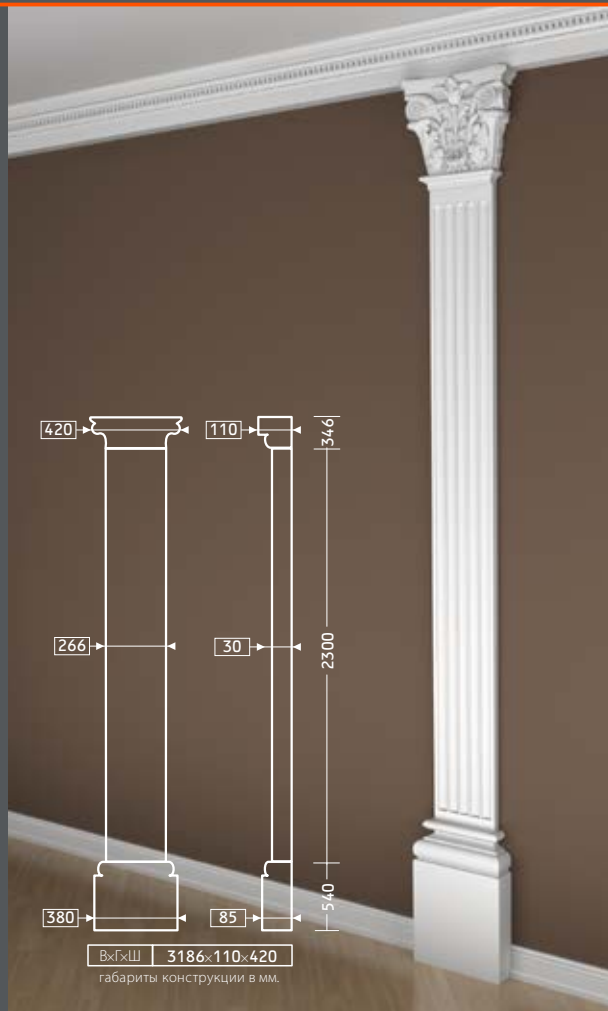

КАПИТЕЛЬ
4.21.201



СТВОЛ
4.22.201



БАЗА
4.23.201

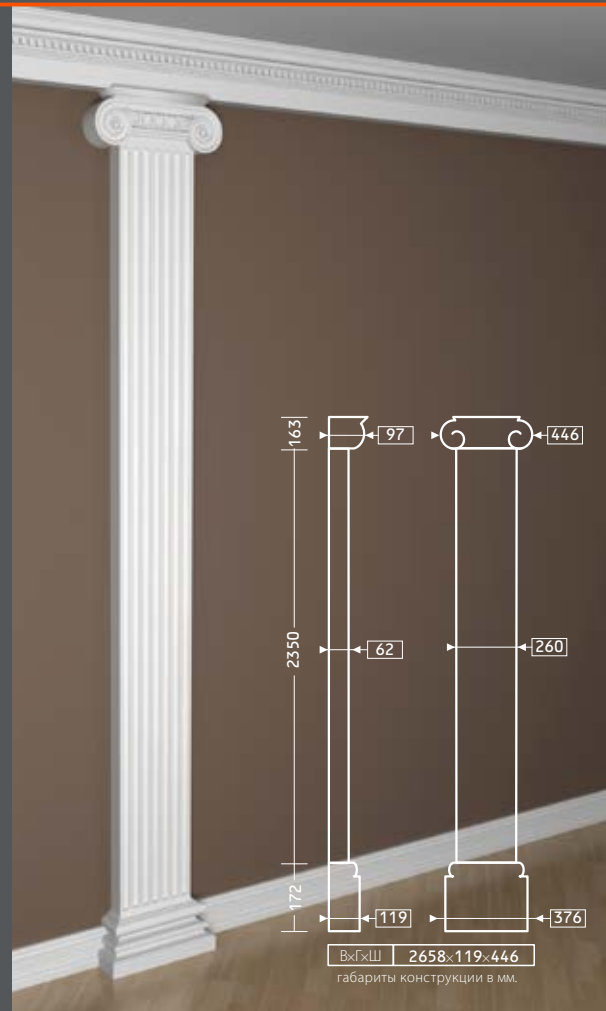
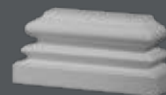

КАПИТЕЛЬ
4.21.201



СТВОЛ
4.22.202



БАЗА
4.23.201

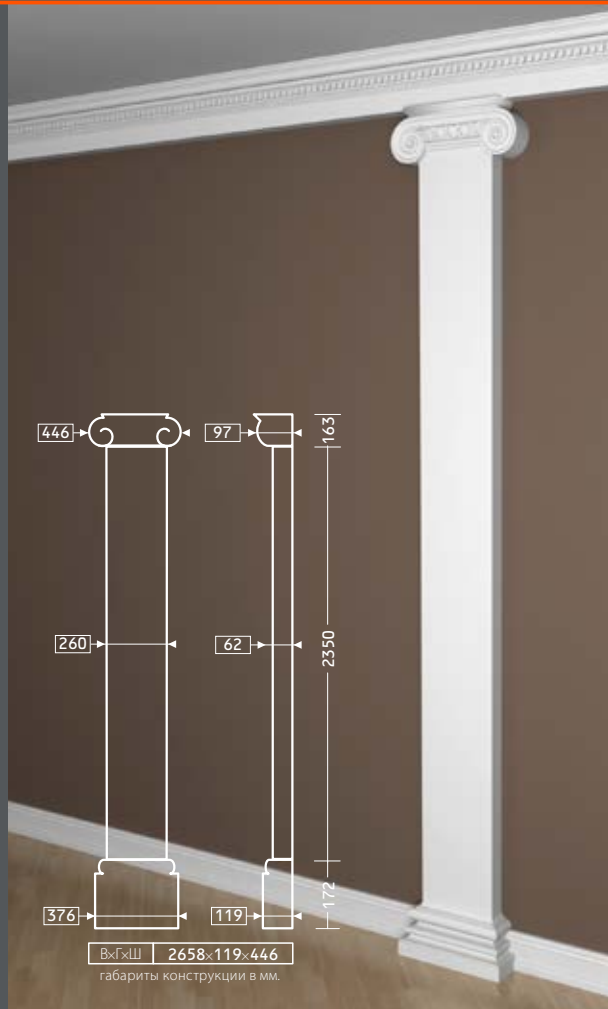
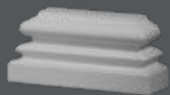

КАПИТЕЛЬ
1.21.006



СТВОЛ
1.22.020



БАЗА
1.23.200

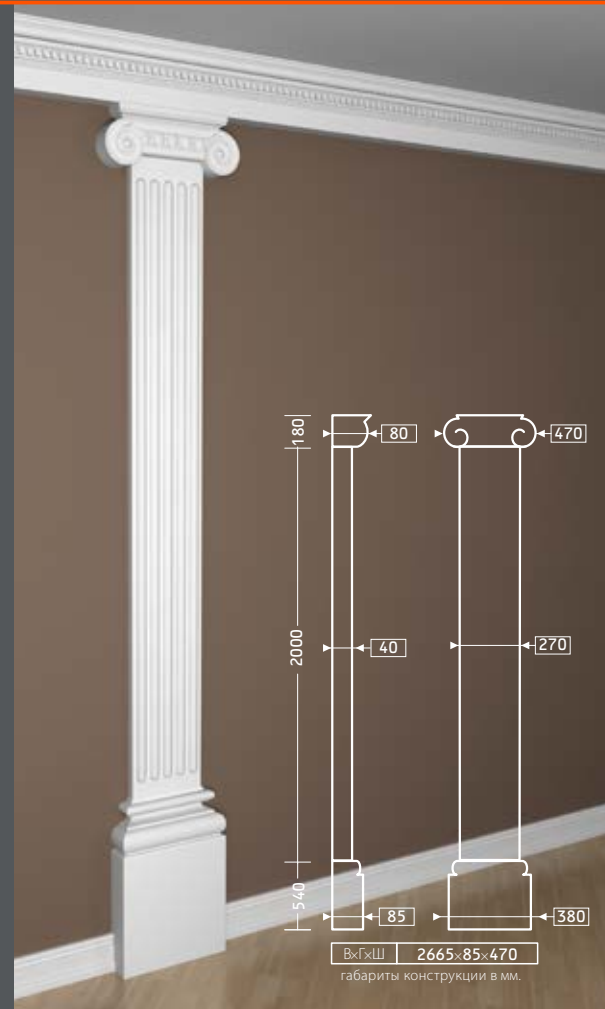

КАПИТЕЛЬ
1.21.006



СТВОЛ
1.22.200



БАЗА
1.23.200



ВхГхШ 2965×85×470
габариты конструкции в мм.

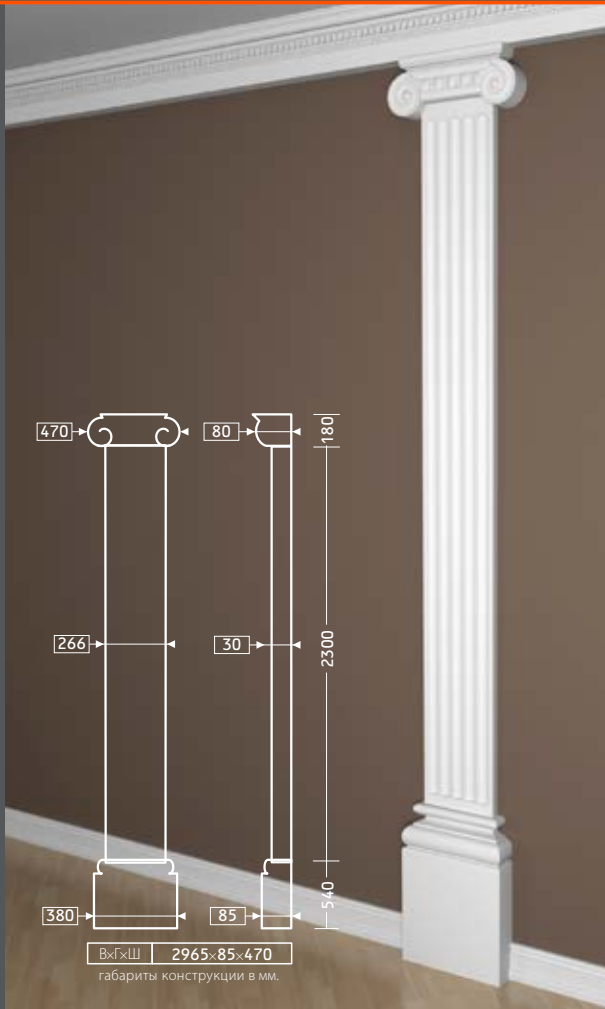

КАПИТЕЛЬ
1.21.008



СТВОЛ
1.22.050



БАЗА
1.23.600



ВхГхШ 2406×46×117
габариты конструкции в мм.

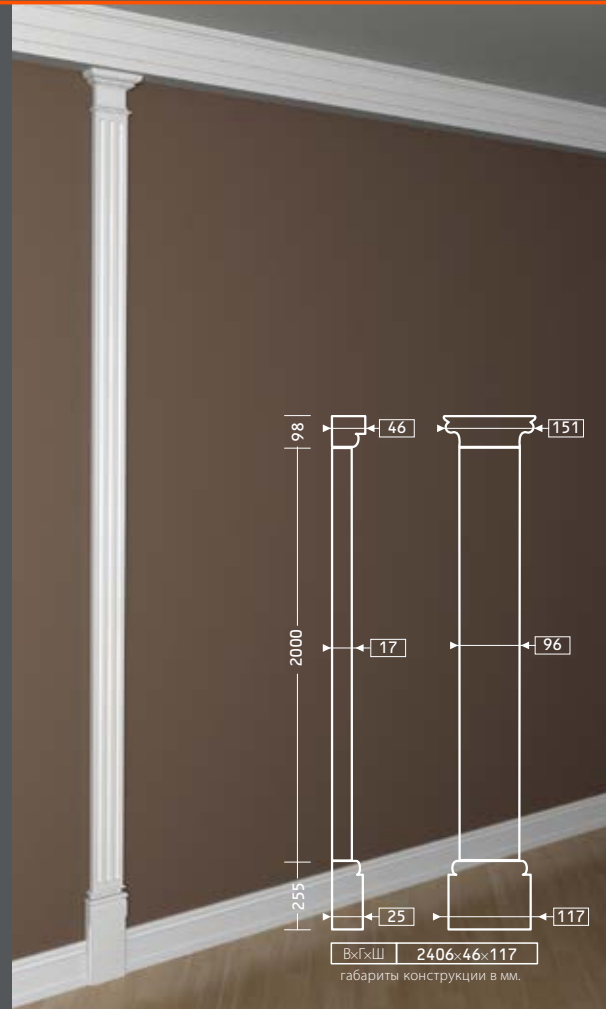

КАПИТЕЛЬ
1.21.004

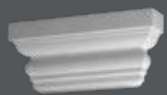

СТВОЛ
1.22.040



БАЗА
1.23.400

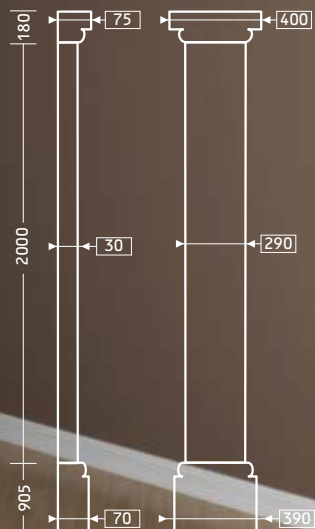

ВхГхШ 3085х75х400
габариты конструкции в мм.

КАПИТЕЛЬ
1.21.005

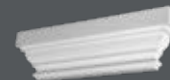

БАЗА
1.23.500

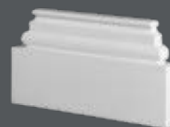

МОЛДИНГ
1.51.307

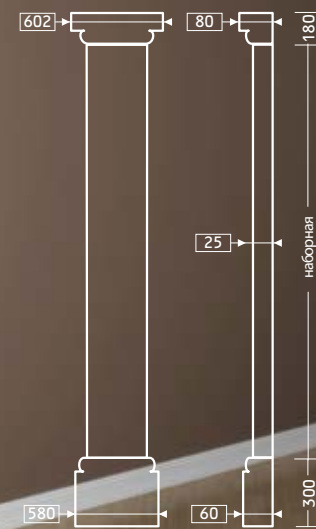
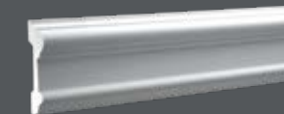

ВхГхШ наборная: 80х602
габариты конструкции в мм.

КАПИТЕЛЬ 4.21.101
СТВОЛ 4.22.101

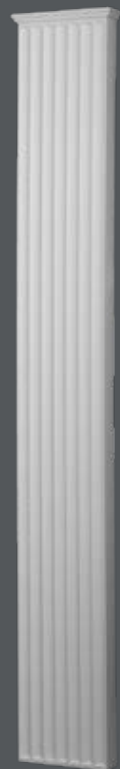

БАЗА 4.23.101

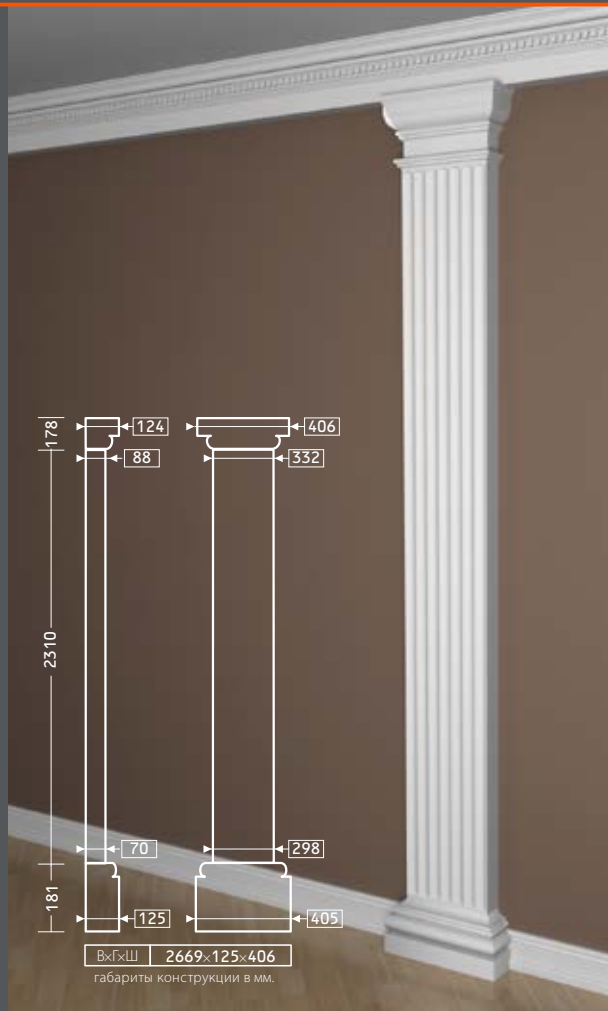
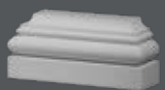

КАПИТЕЛЬ 4.21.101
СТВОЛ 4.22.102



БАЗА 4.23.101

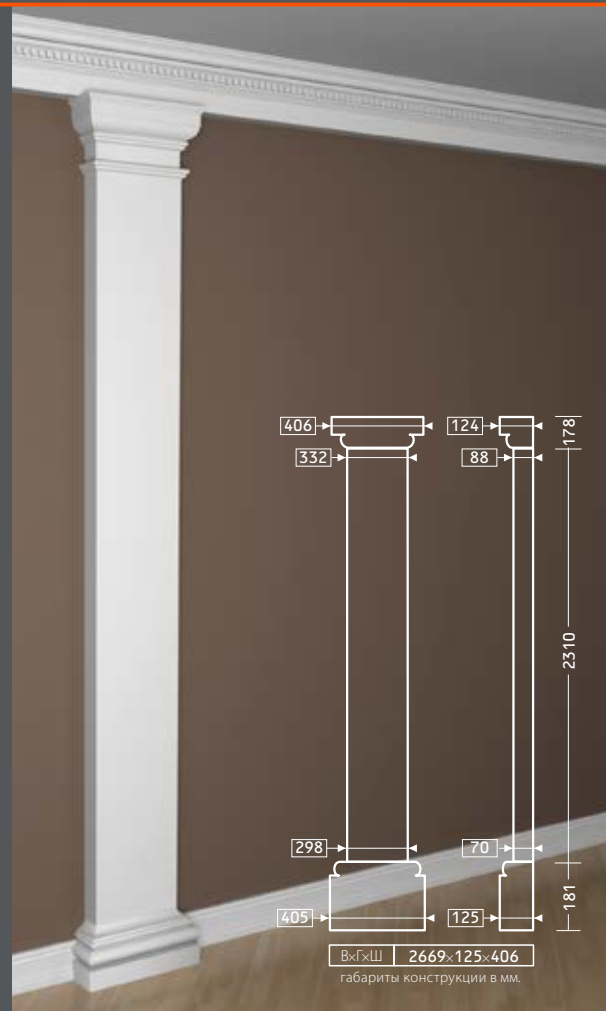
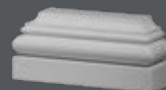

КАПИТЕЛЬ 1.21.007
 СТВОЛ 1.22.030



БАЗА 1.23.300

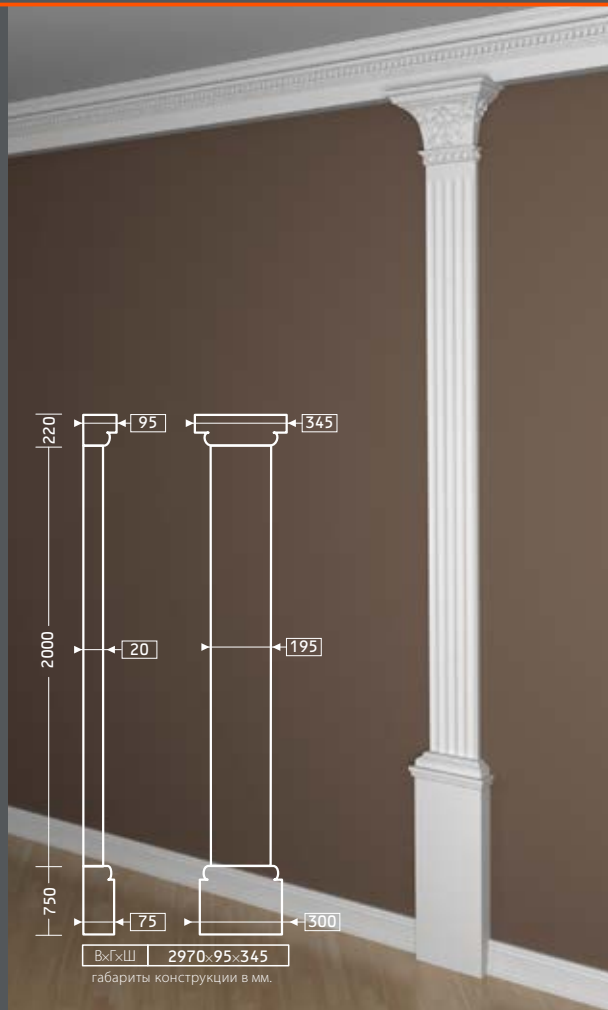

КАПИТЕЛЬ 1.21.003
 СТВОЛ 1.22.030

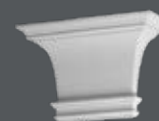

БАЗА 1.23.300

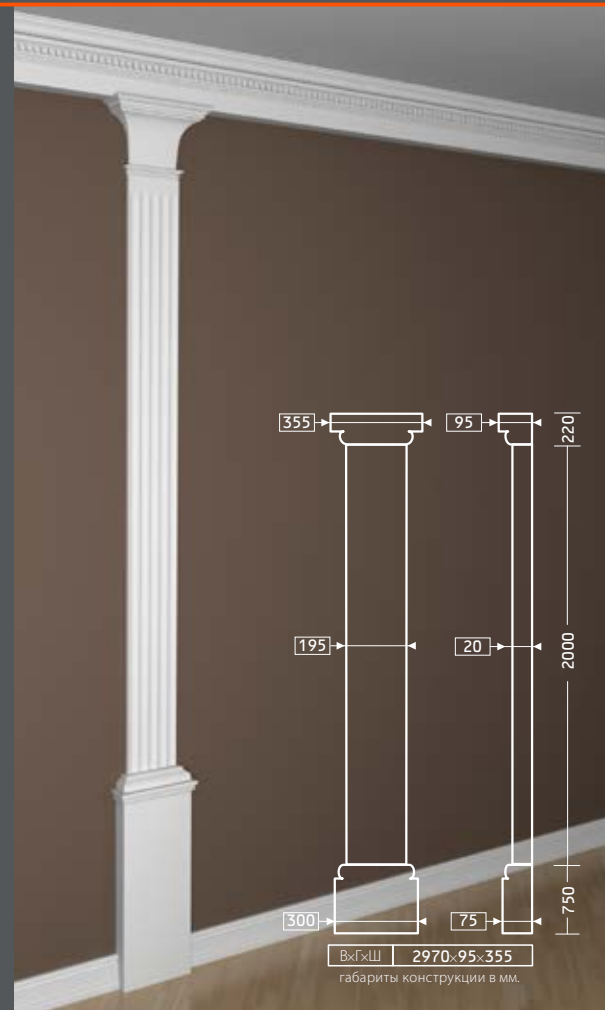



ПОЛУКОЛОННЫ

КАПИТЕЛЬ 1.15.010
СТВОЛ 1.16.080



БАЗА 1.17.900

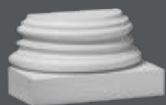

ПЬЕДЕСТАЛ 1.18.003

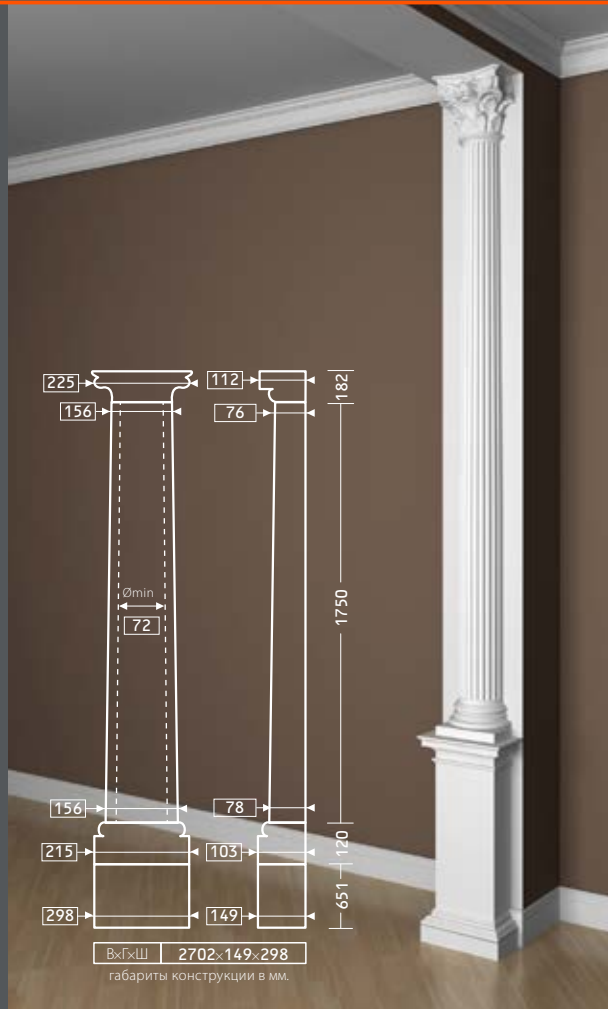

КАПИТЕЛЬ 1.15.010
СТВОЛ 1.16.081



БАЗА 1.17.900

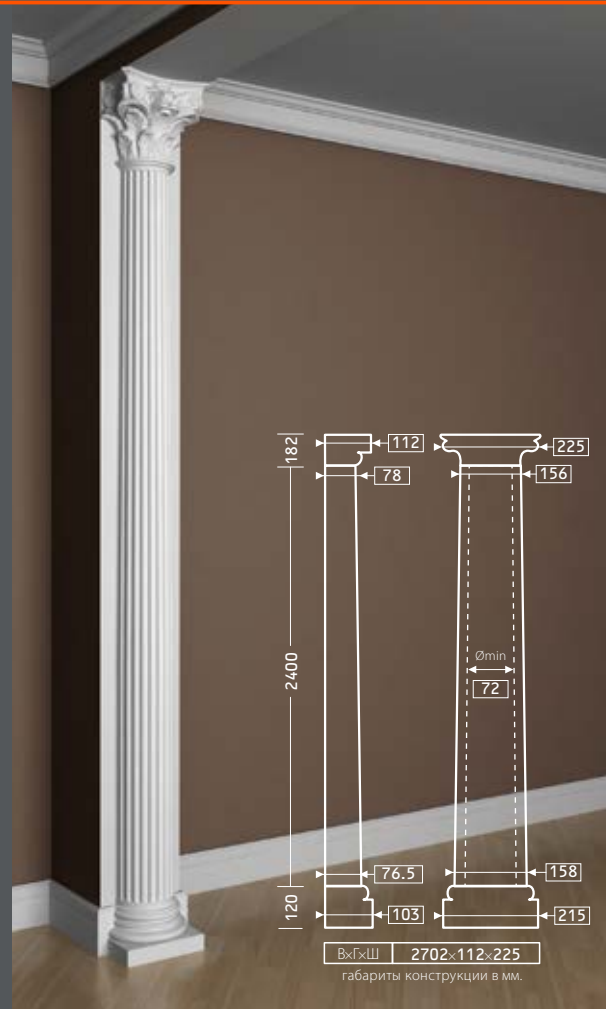
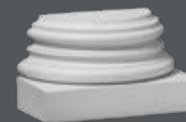

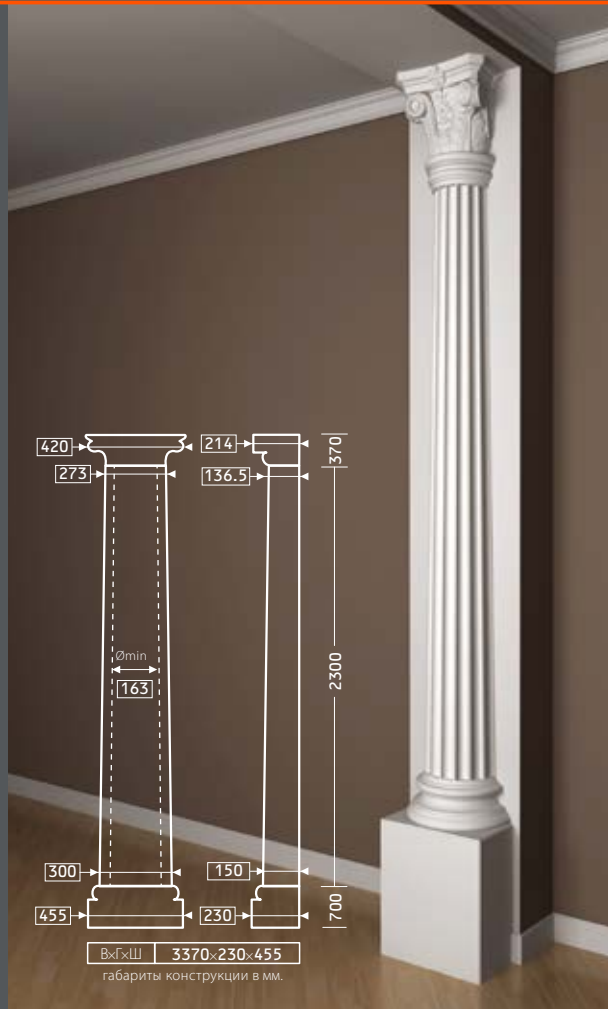
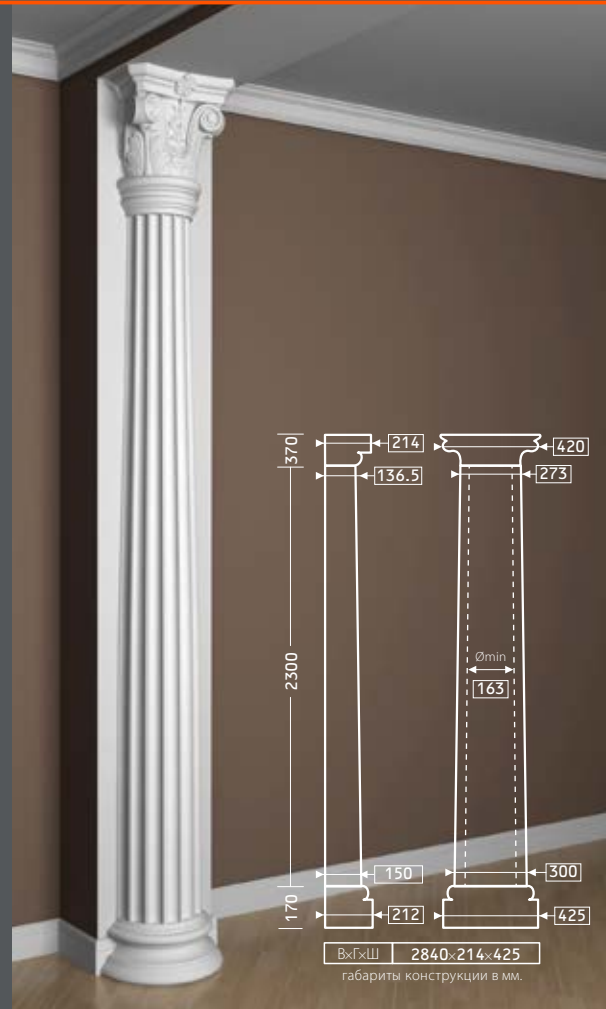
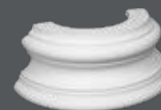
КАПИТЕЛЬ
1.15.001СТВОЛ
1.16.030БАЗА
1.17.300КАПИТЕЛЬ
1.15.001СТВОЛ
1.16.030БАЗА
1.17.400

КАПИТЕЛЬ
4.15.301

СТВОЛ
4.16.301

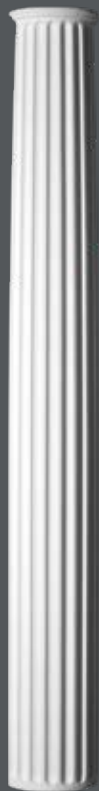

БАЗА
4.17.301

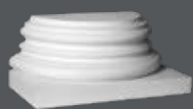

БАЗА
4.17.302

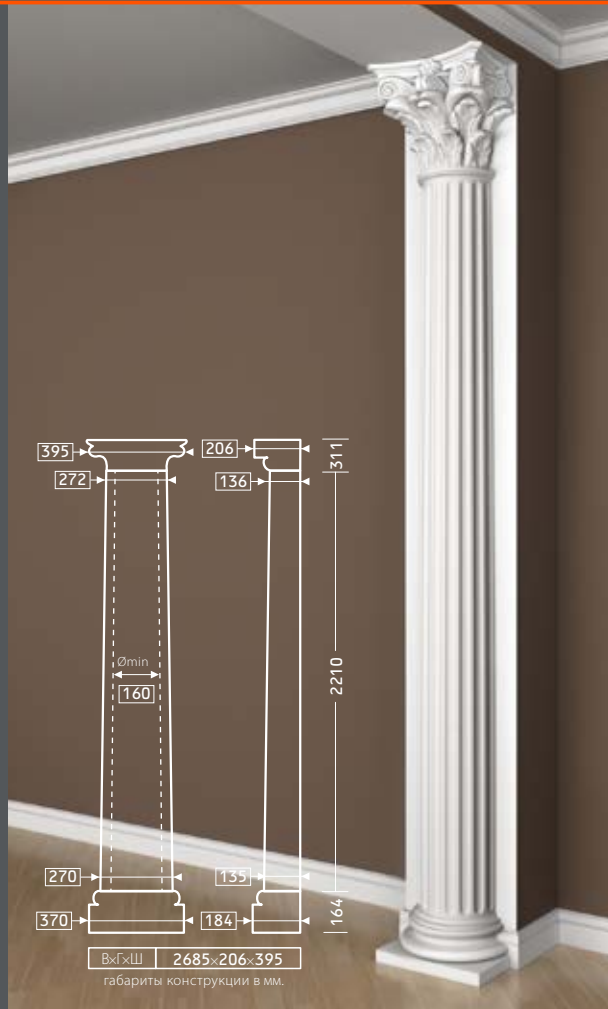
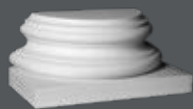

КАПИТЕЛЬ
4.15.302

СТВОЛ
4.16.003



СТВОЛ
4.16.004



БАЗА
4.17.002



СТВОЛ
4.16.005

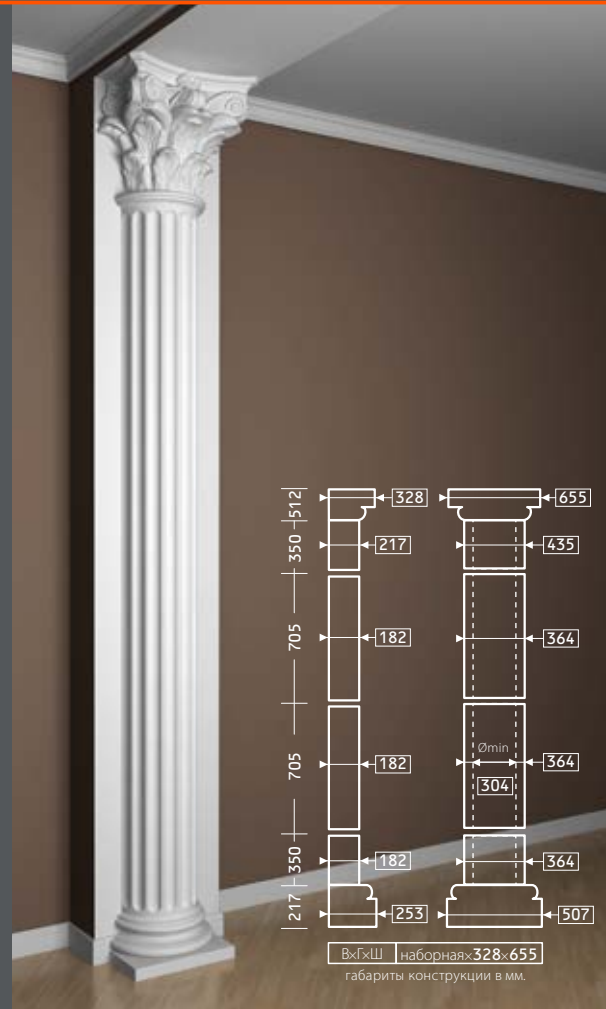

КАПИТЕЛЬ
1.15.009



БАЗА
1.17.800

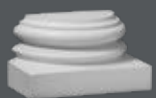

ПЬЕДЕСТАЛ
1.18.002

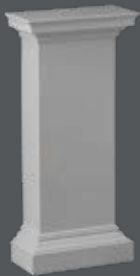

СТВОЛ
1.16.070

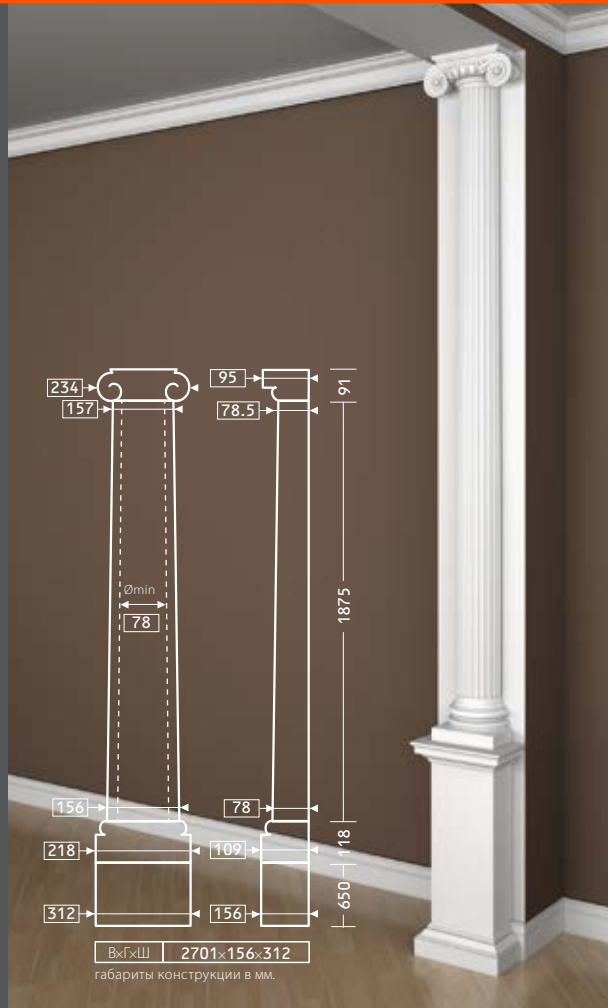

КАПИТЕЛЬ
1.15.009



БАЗА
1.17.800

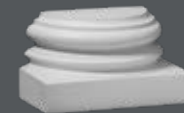

СТВОЛ
1.16.071

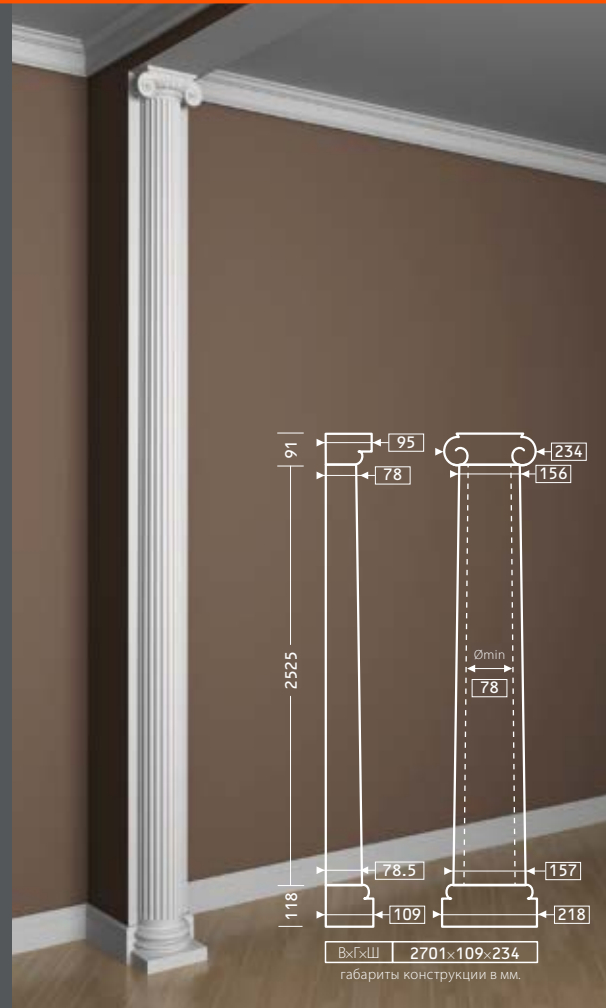

КАПИТЕЛЬ
1.15.006



СТВОЛ
1.16.050



БАЗА
1.17.500

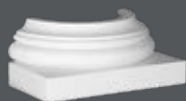

БАЗА
1.17.600

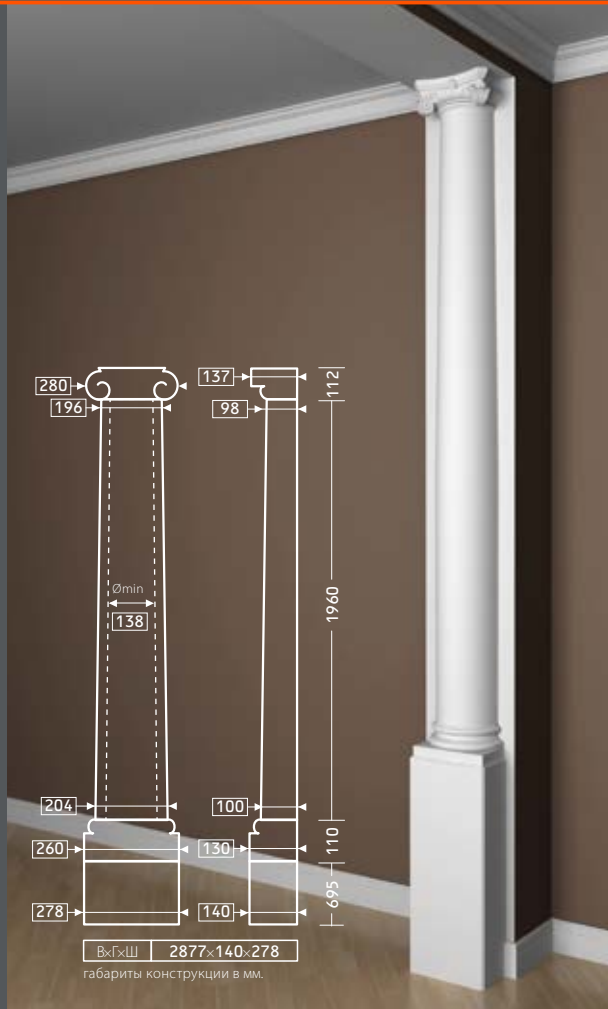

КАПИТЕЛЬ
1.15.006



СТВОЛ
1.16.050



БАЗА
1.17.500

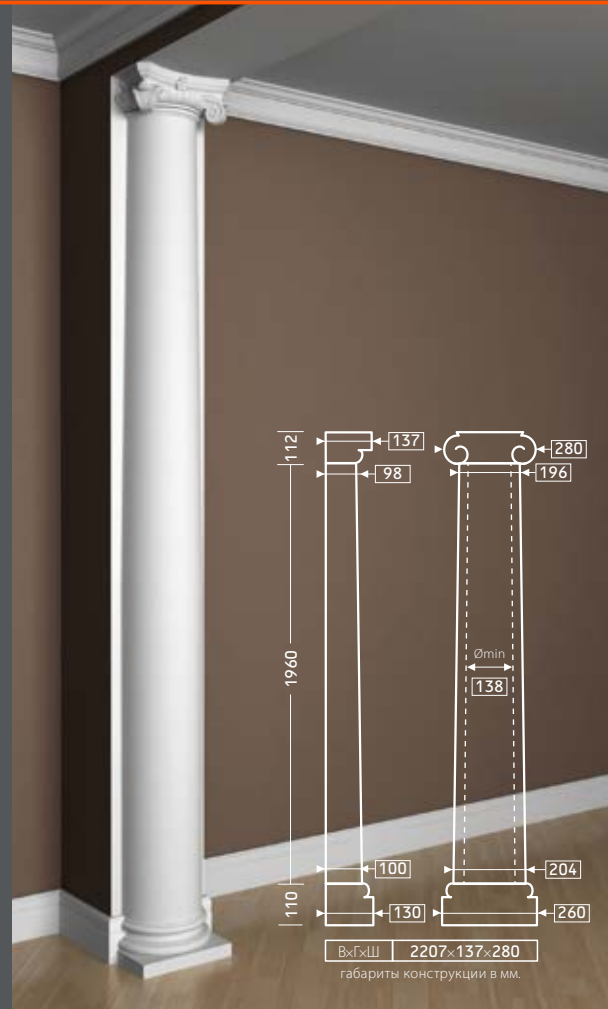
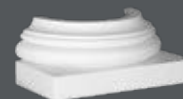

КАПИТЕЛЬ
1.15.003СТВОЛ
1.16.010ПОЛУКОЛЬЦО
1.15.100БАЗА
1.17.100

ВхГхШ 3150×196×392
габариты конструкции в мм.

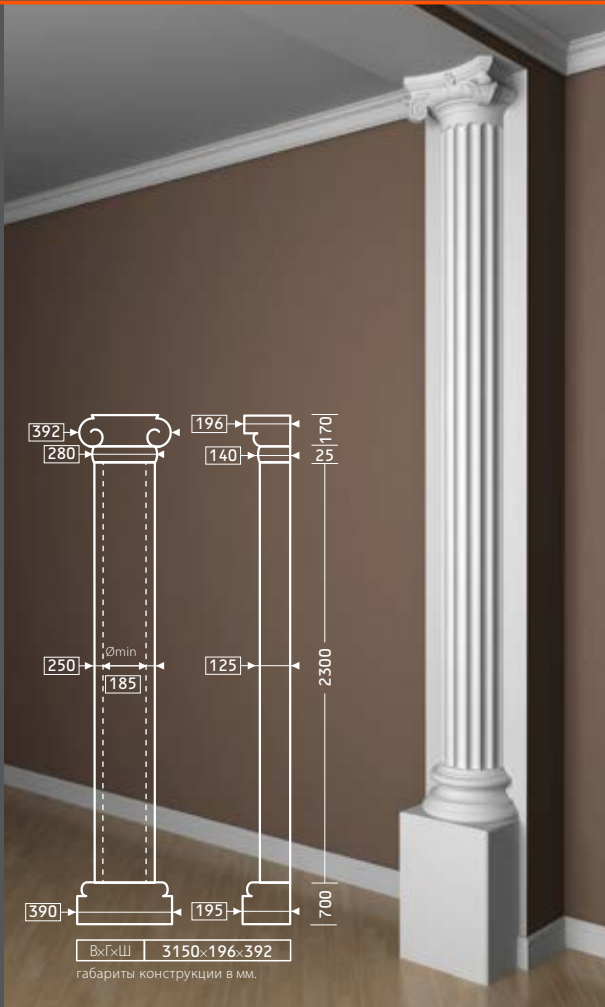
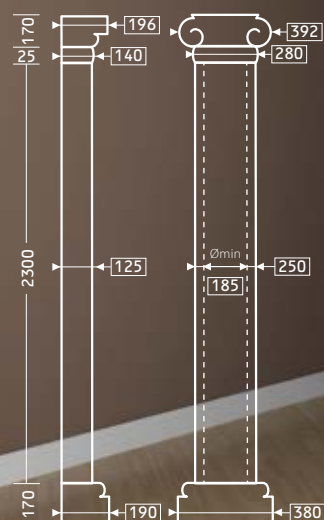
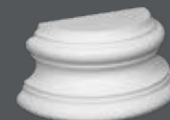
КАПИТЕЛЬ
1.15.003СТВОЛ
1.16.010ПОЛУКОЛЬЦО
1.15.100БАЗА
1.17.200

ВхГхШ 2620×196×392
габариты конструкции в мм.

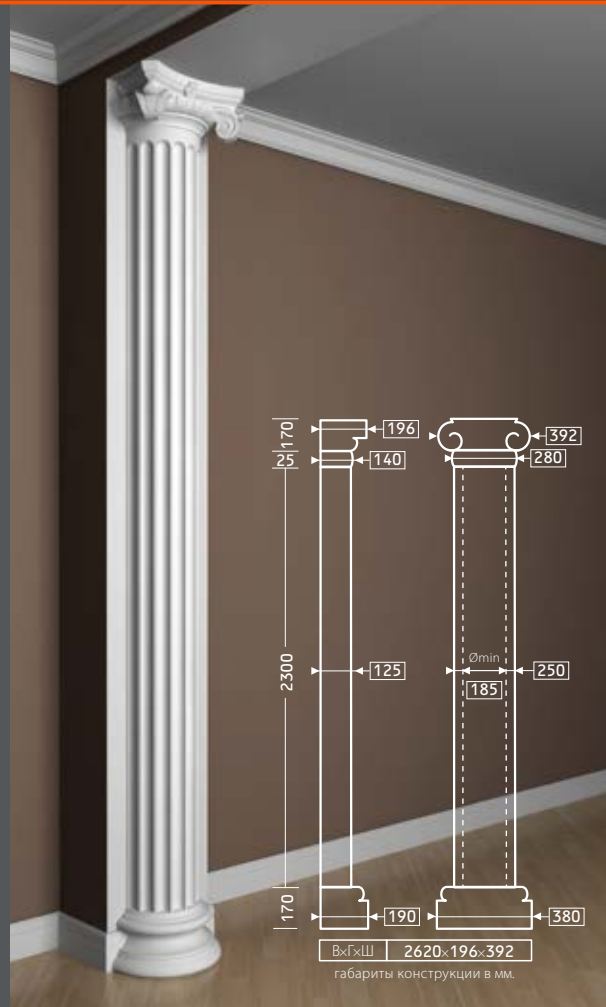

КАПИТЕЛЬ
1.15.003



СТВОЛ
1.16.011



БАЗА
1.17.100

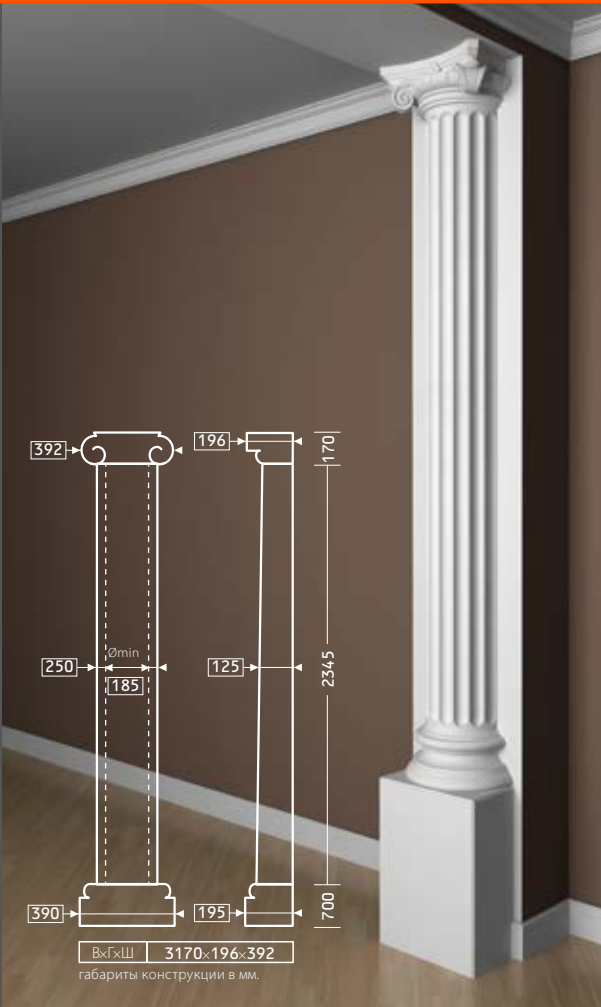

КАПИТЕЛЬ
1.15.004



СТВОЛ
1.16.010



ПОЛУКОЛЬЦО
1.15.300



БАЗА
1.17.100

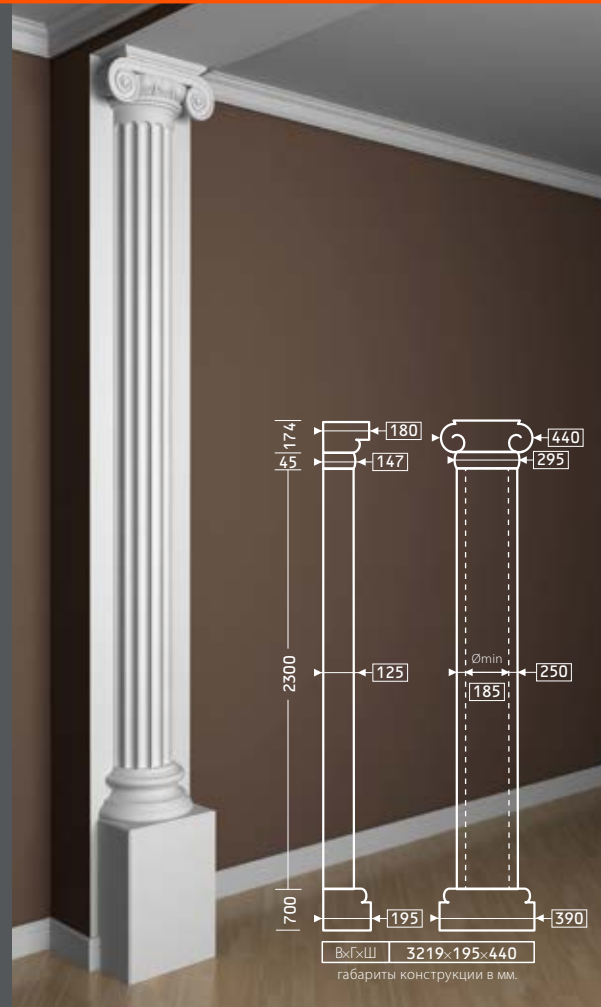

КАПИТЕЛЬ
1.15.004



СТВОЛ
1.16.010



ПОЛУКОЛЬЦО
1.15.300



БАЗА
1.17.200

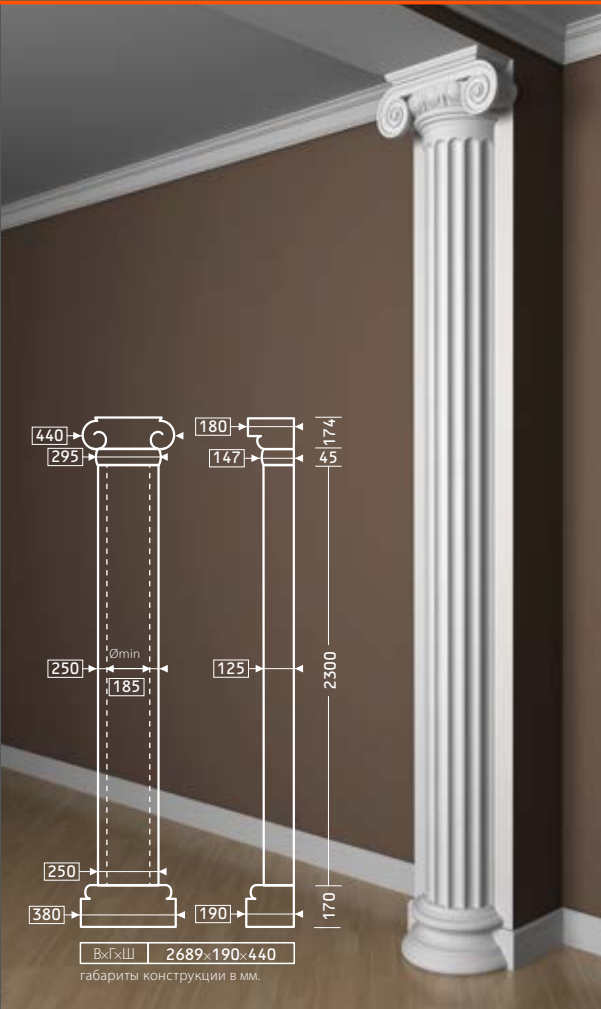
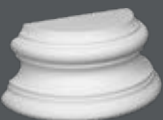

КАПИТЕЛЬ
1.15.004



СТВОЛ
1.16.011



БАЗА
1.17.200

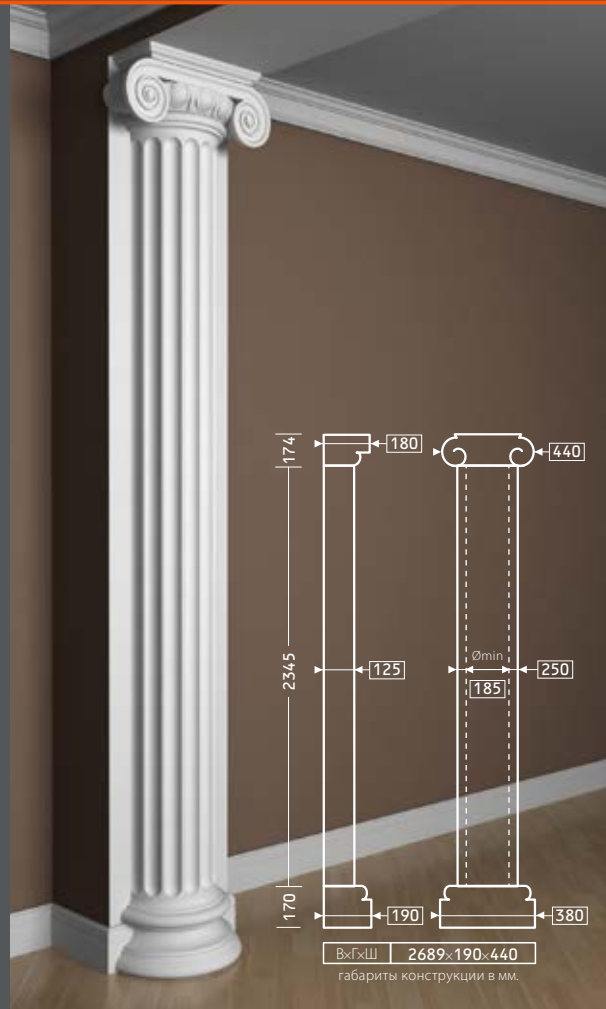
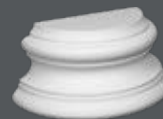

КАПИТЕЛЬ
1.15.003



СТВОЛ
1.16.020



ПОЛУКОЛЬЦО
1.15.200



БАЗА
1.17.100

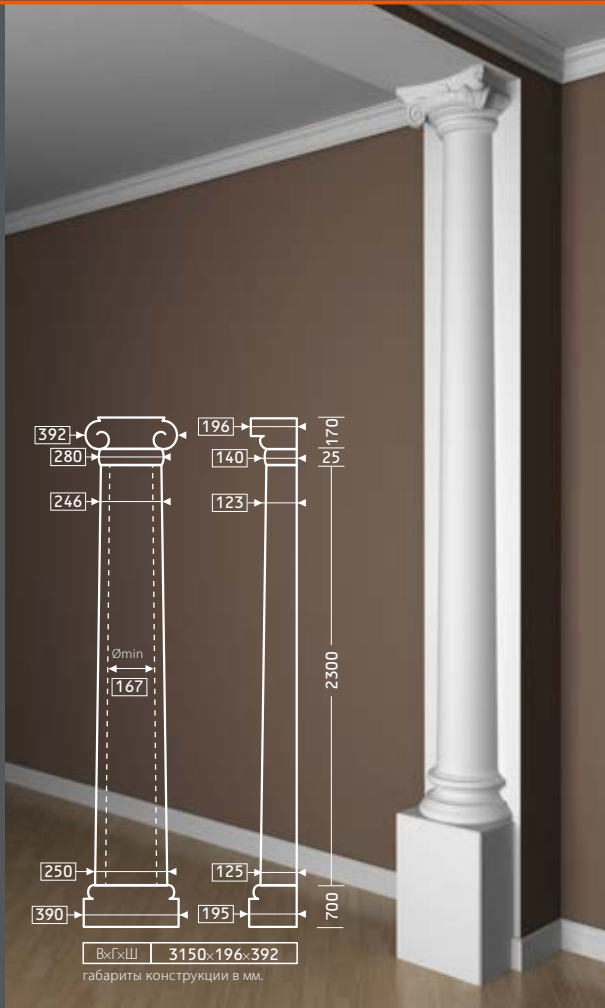

КАПИТЕЛЬ
1.15.003



СТВОЛ
1.16.020



ПОЛУКОЛЬЦО
1.15.200



БАЗА
1.17.200

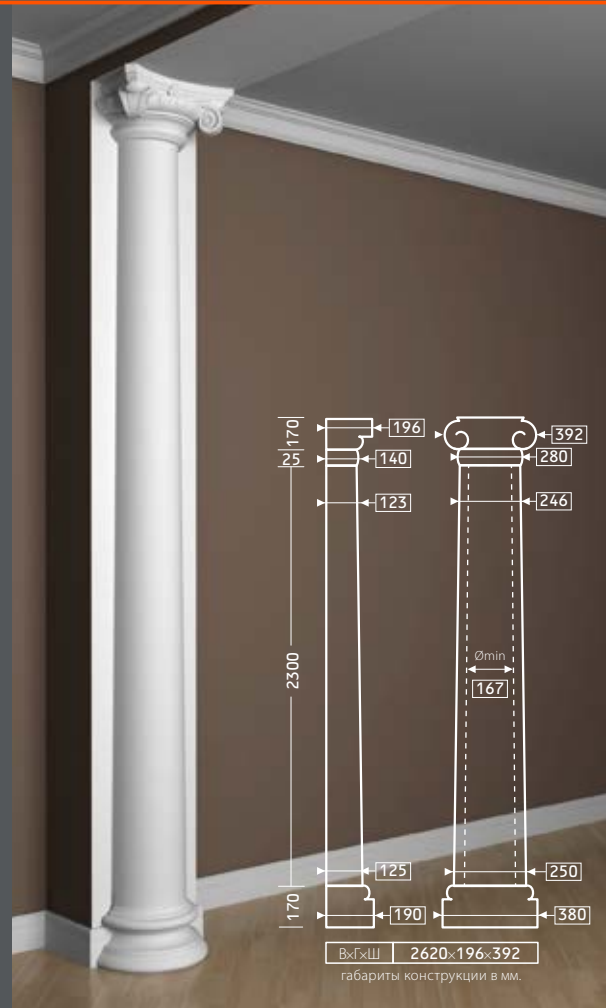
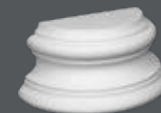

КАПИТЕЛЬ 4.15.201
СТВОЛ 4.16.201



БАЗА 4.17.201



БАЗА 4.17.202

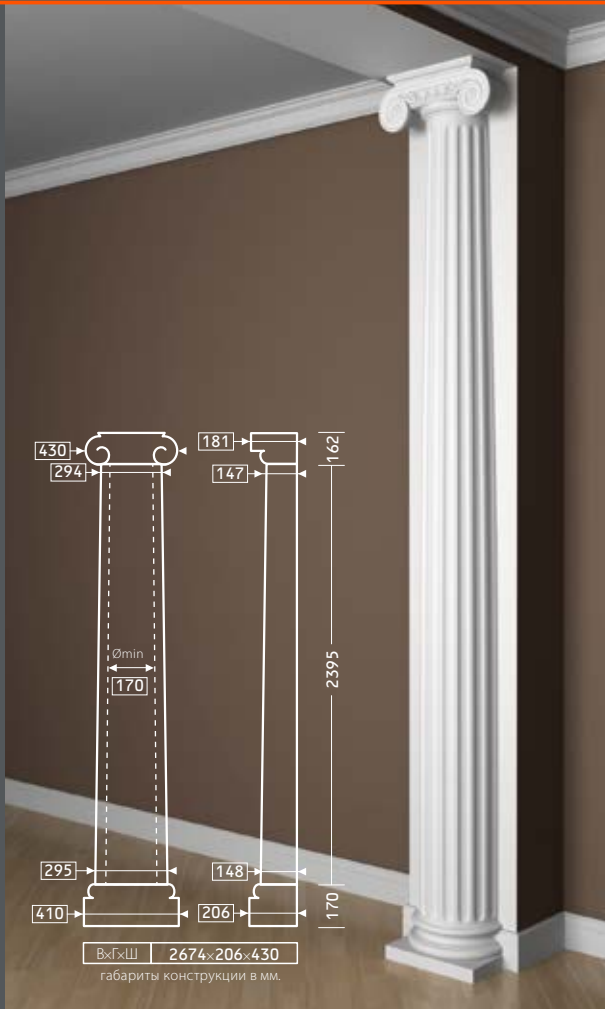
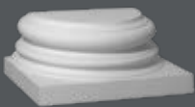

КАПИТЕЛЬ 4.15.201
СТВОЛ 4.16.202



БАЗА 4.17.201

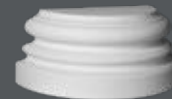

БАЗА 4.17.202

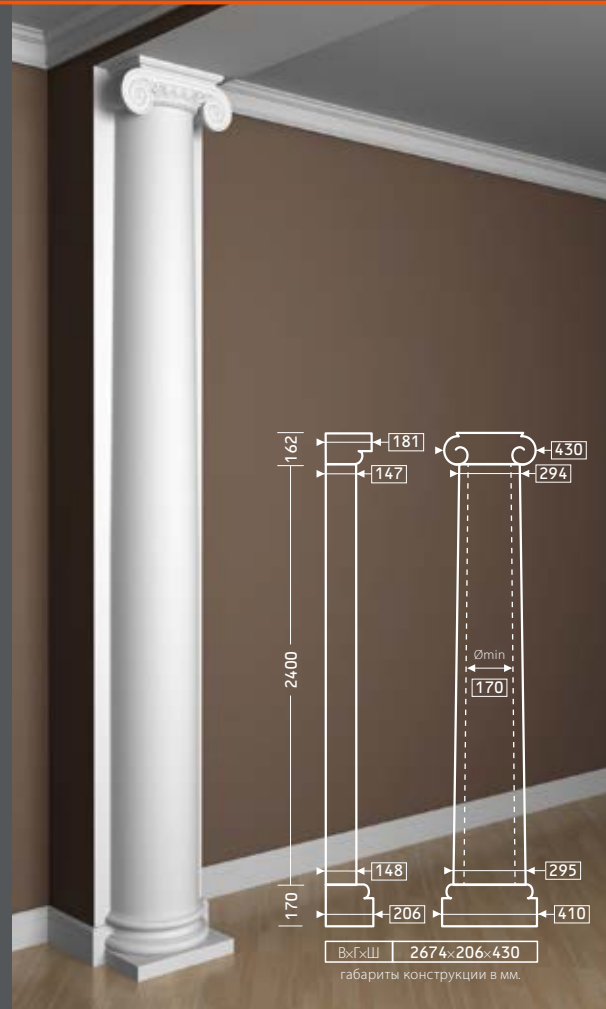
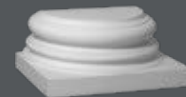

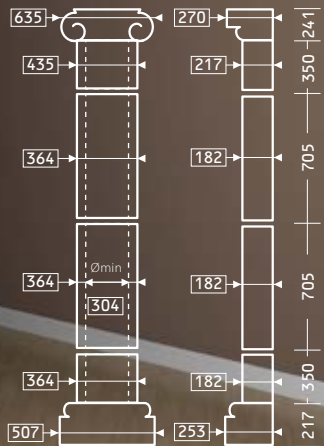
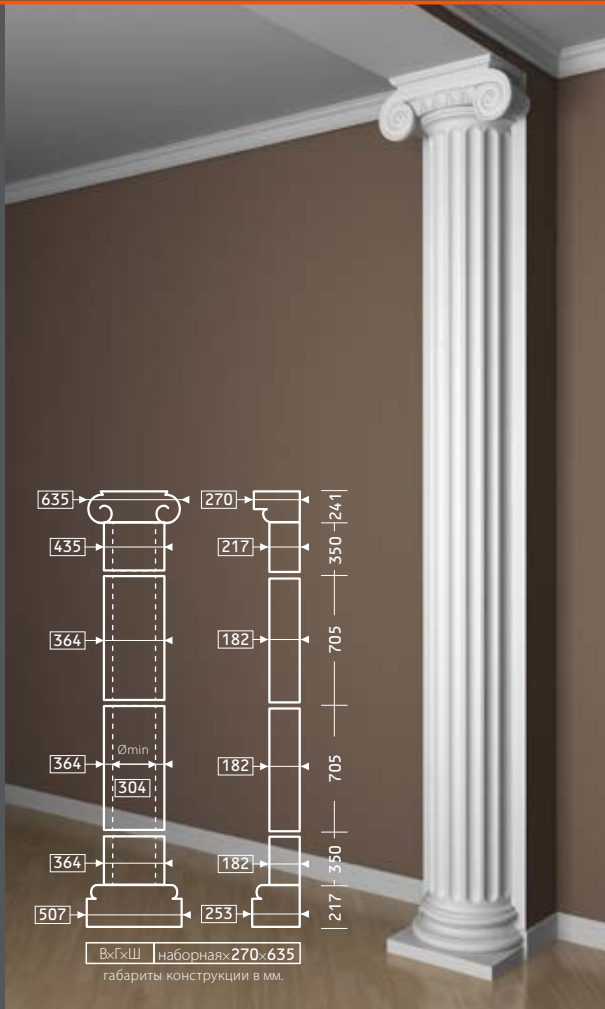
КАПИТЕЛЬ
4.15.202СТВОЛ
4.16.003БАЗА
4.17.002СТВОЛ
4.16.004СТВОЛ
4.16.005

ВхГхШ | наборная: 270×635
габариты конструкции в мм.

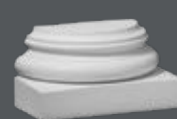
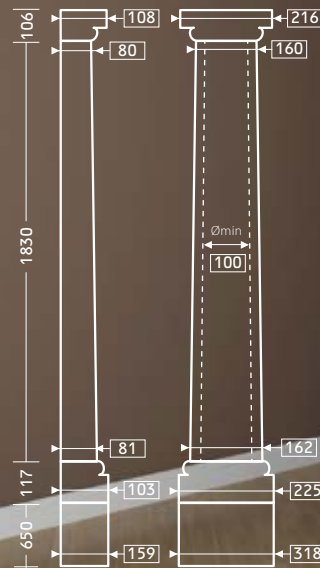
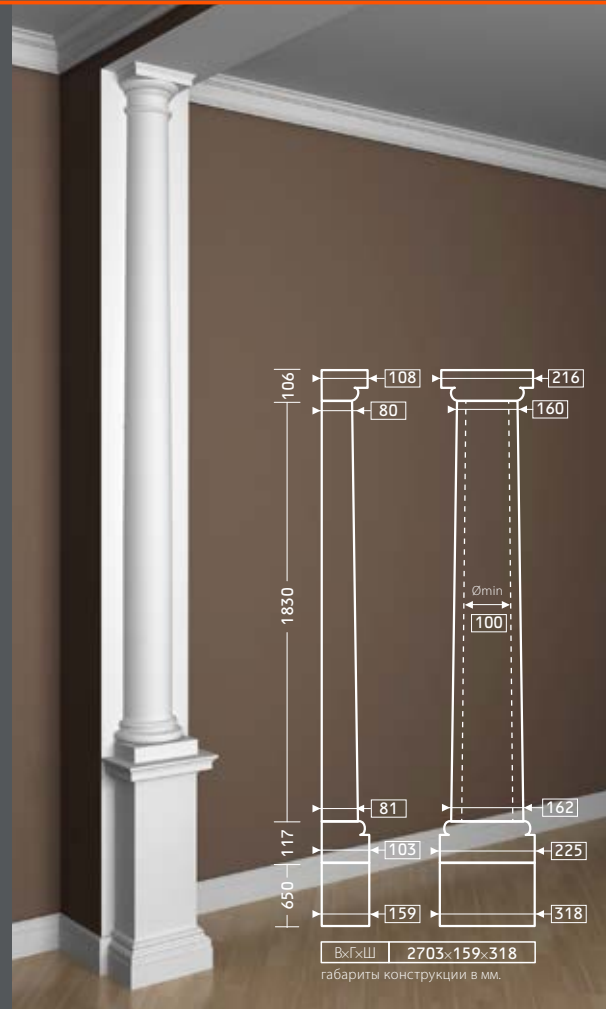
КАПИТЕЛЬ
1.15.008СТВОЛ
1.16.060БАЗА
1.17.700ПЬЕДЕСТАЛ
1.18.001

ВхГхШ | 2703×159×318
габариты конструкции в мм.

КАПИТЕЛЬ
1.15.008

СТВОЛ
1.16.061



БАЗА
1.17.700

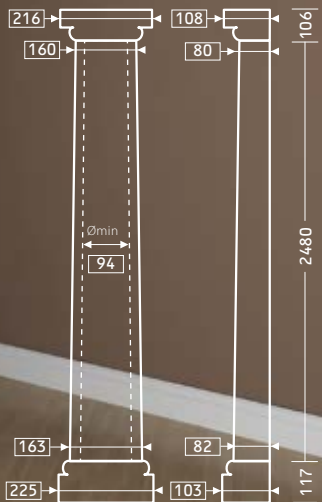
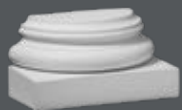

ВхГхШ 2703×108×225
габариты конструкции в мм.

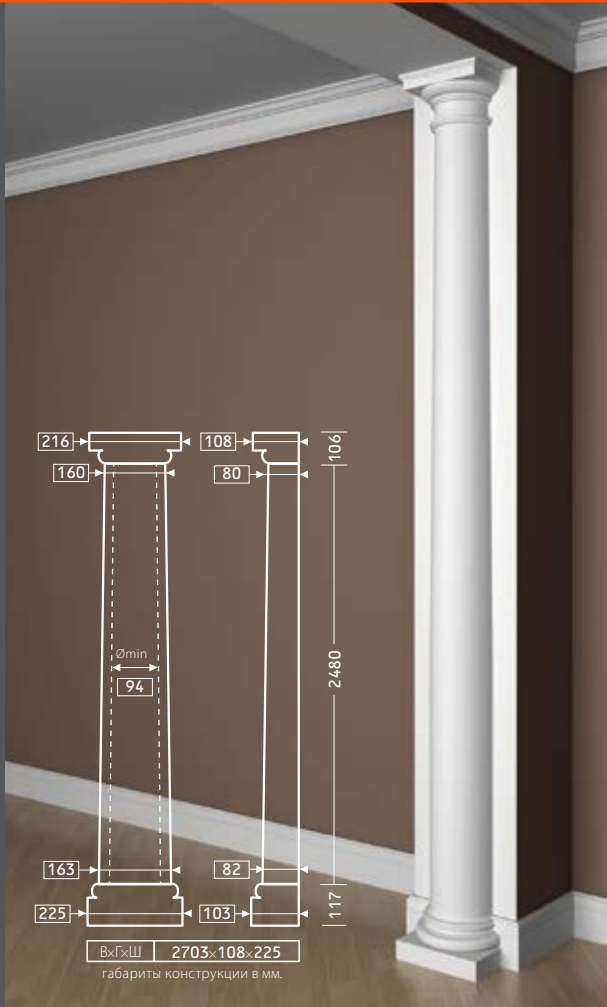

КАПИТЕЛЬ
1.15.005

СТВОЛ
1.16.050



БАЗА
1.17.500

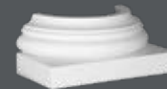

БАЗА
1.17.600

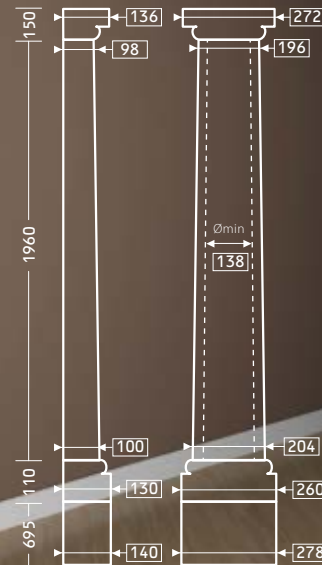

ВхГхШ 2890×140×278
габариты конструкции в мм.

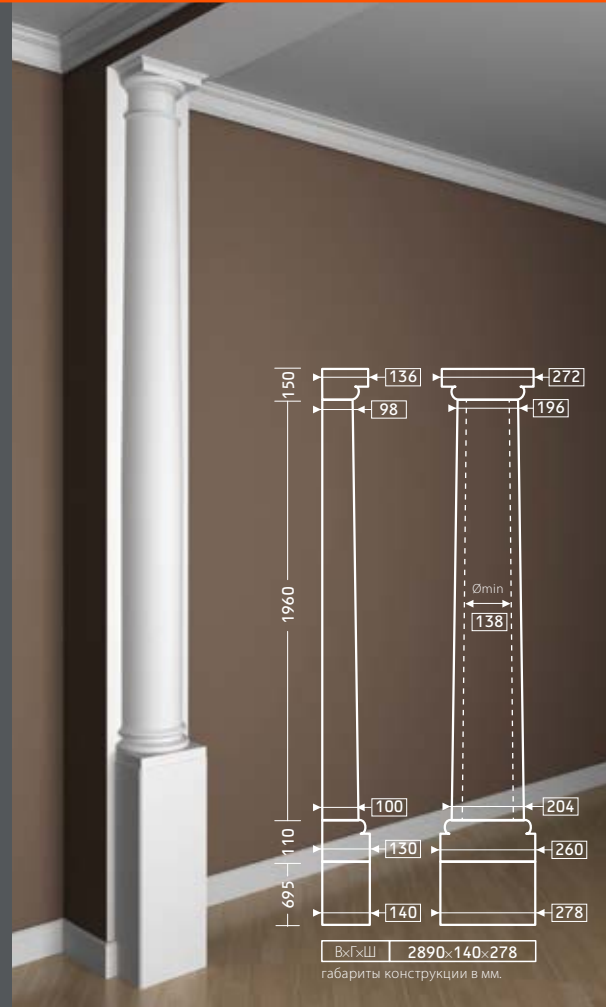

КАПИТЕЛЬ
1.15.005

СТВОЛ
1.16.050



БАЗА
1.17.500

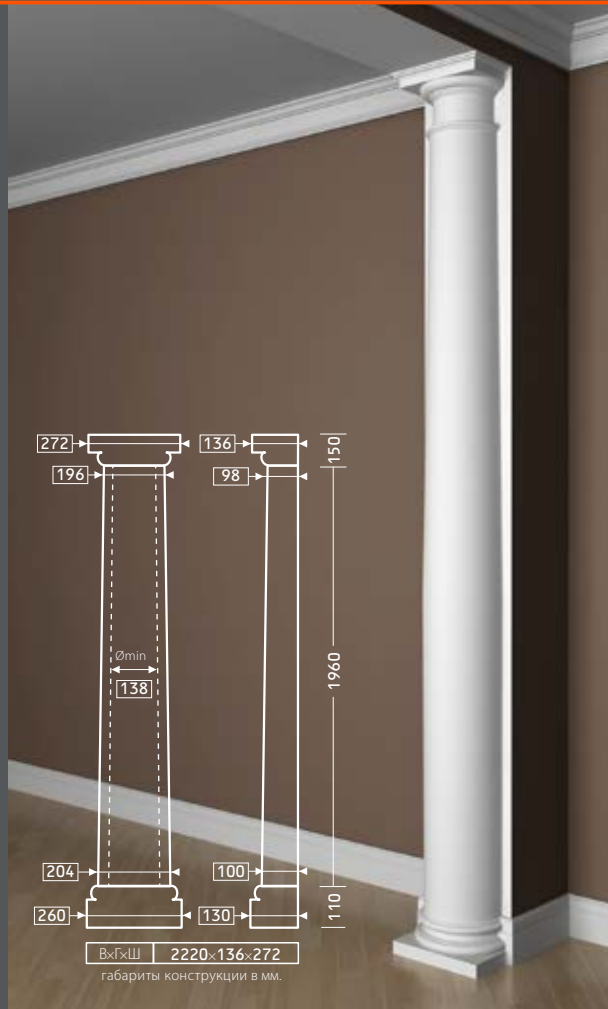
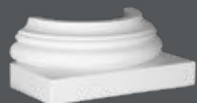

КАПИТЕЛЬ
1.15.002

СТВОЛ
1.16.020



БАЗА
1.17.100

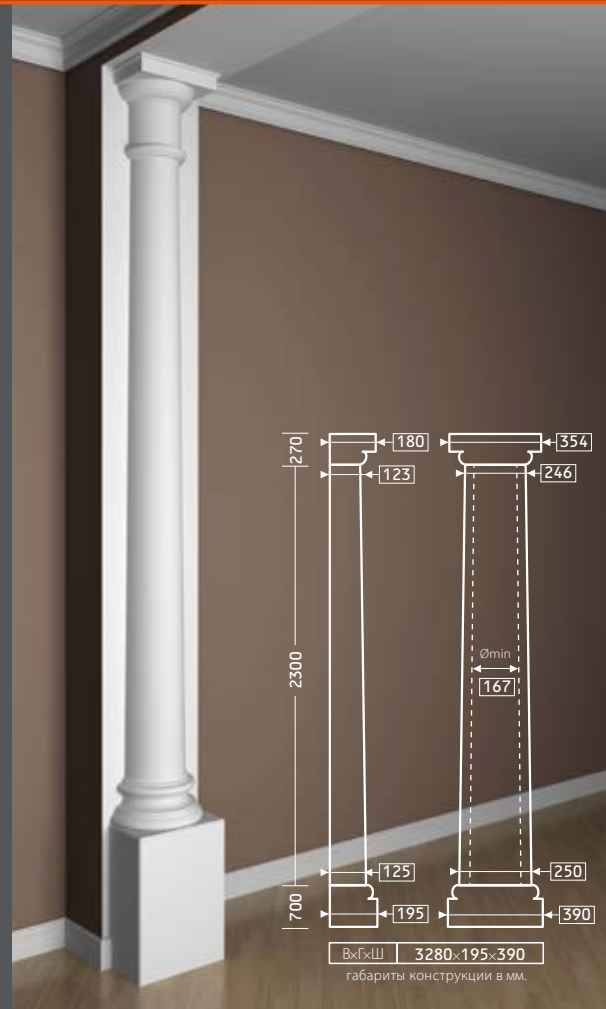

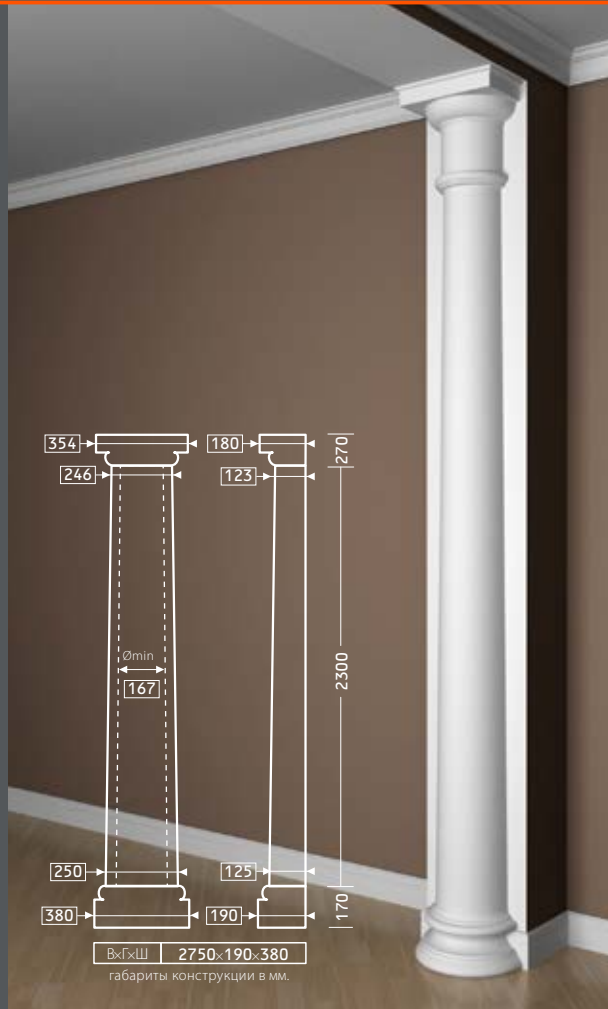
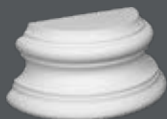
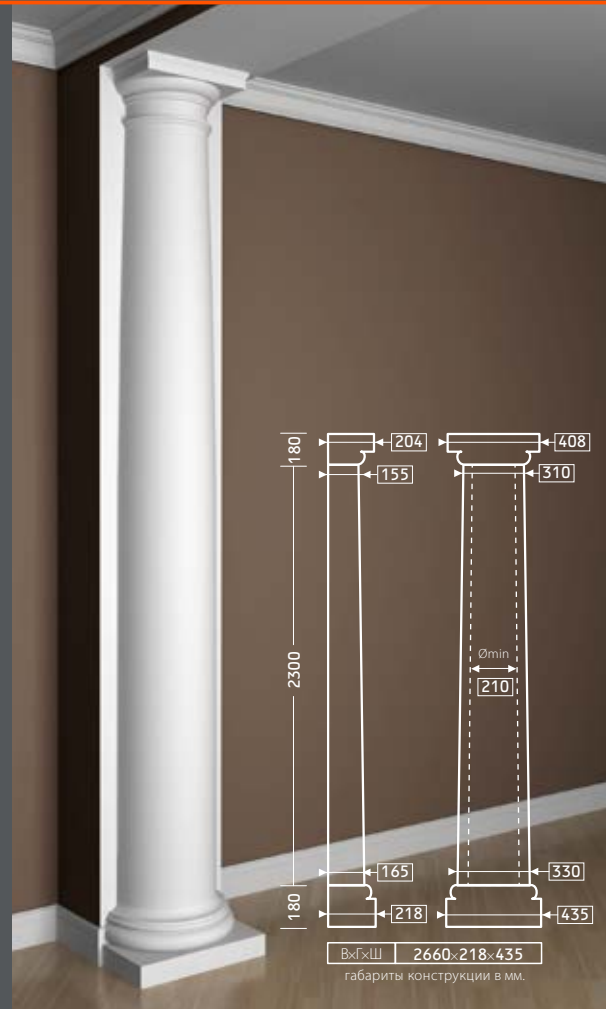
КАПИТЕЛЬ
1.15.002СТВОЛ
1.16.020БАЗА
1.17.200КАПИТЕЛЬ
4.15.101СТВОЛ
4.16.101БАЗА
4.17.101

КАПИТЕЛЬ 4.15.101
СТВОЛ 4.16.102

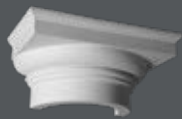

БАЗА 4.17.101

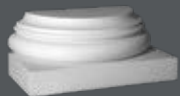

КАПИТЕЛЬ 4.15.102
СТВОЛ 4.16.001



БАЗА 4.17.001
СТВОЛ 4.16.002

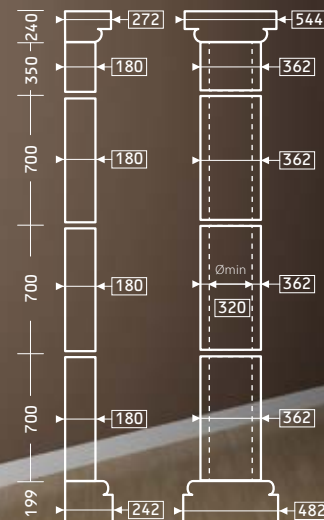

A photograph of a modern interior space with classical architectural elements. Two white columns with Corinthian capitals support a decorative ceiling. A dining table with chairs is in the center, and a large spherical light fixture hangs from the ceiling. A dark teal overlay covers the right side of the image, containing the word 'КОЛОННЫ' in white text.

КОЛОННЫ

КАПИТЕЛЬ
1.11.010



БАЗА
1.13.900



ПЬЕДЕСТАЛ
1.14.003

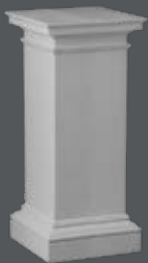

СТВОЛ
1.12.080

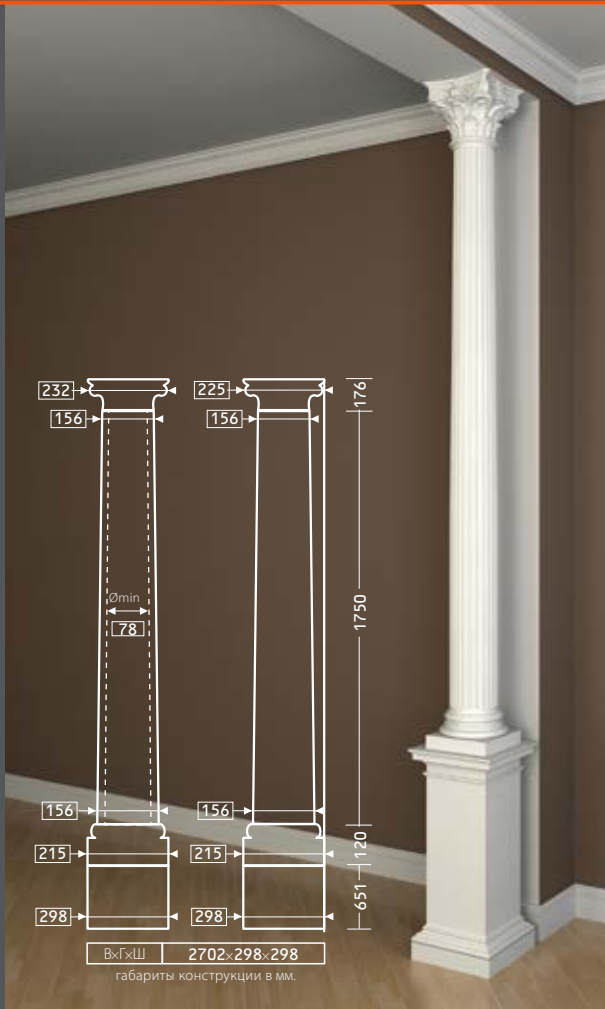

КАПИТЕЛЬ
1.11.010



БАЗА
1.13.900

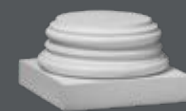

СТВОЛ
1.12.081

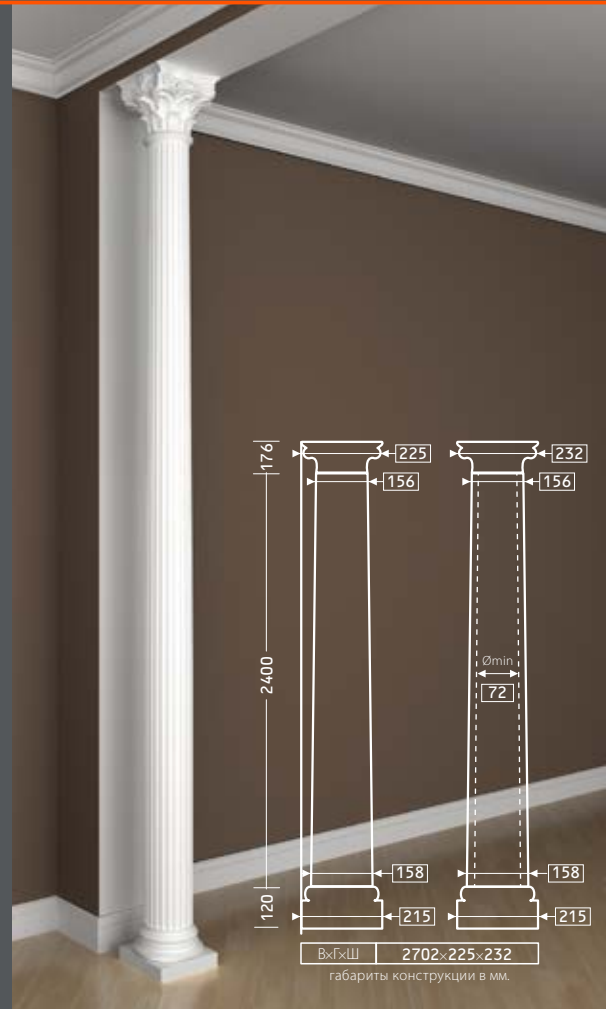

КАПИТЕЛЬ
1.11.001



СТВОЛ
1.12.030



БАЗА
1.13.300



В×Г×Ш 3370×455×455
габариты конструкции в мм.

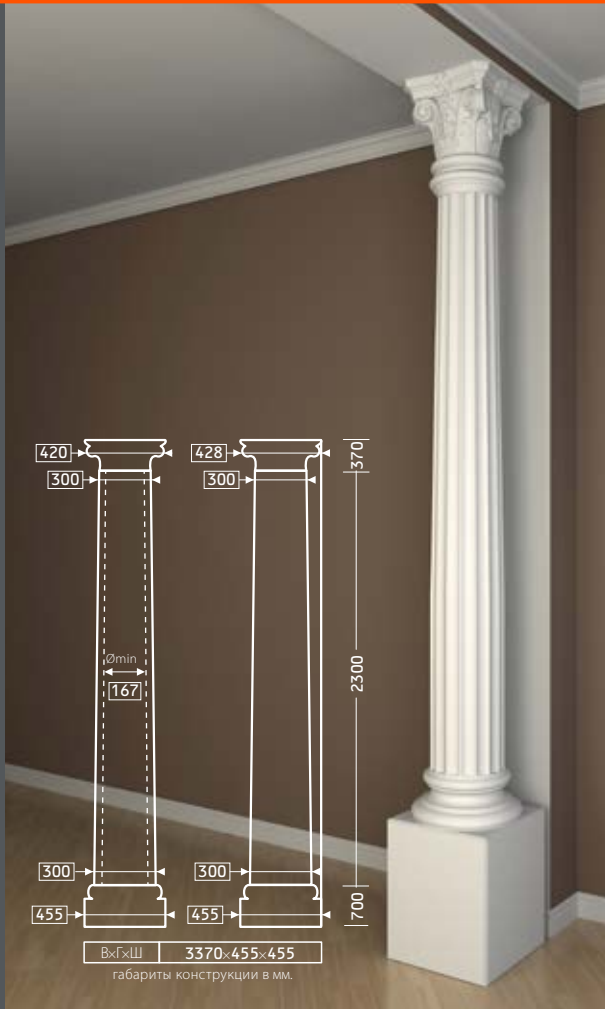

КАПИТЕЛЬ
1.11.001



СТВОЛ
1.12.030



БАЗА
1.13.400

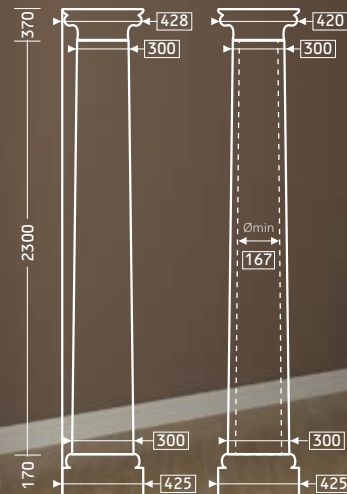

В×Г×Ш 2840×428×425
габариты конструкции в мм.

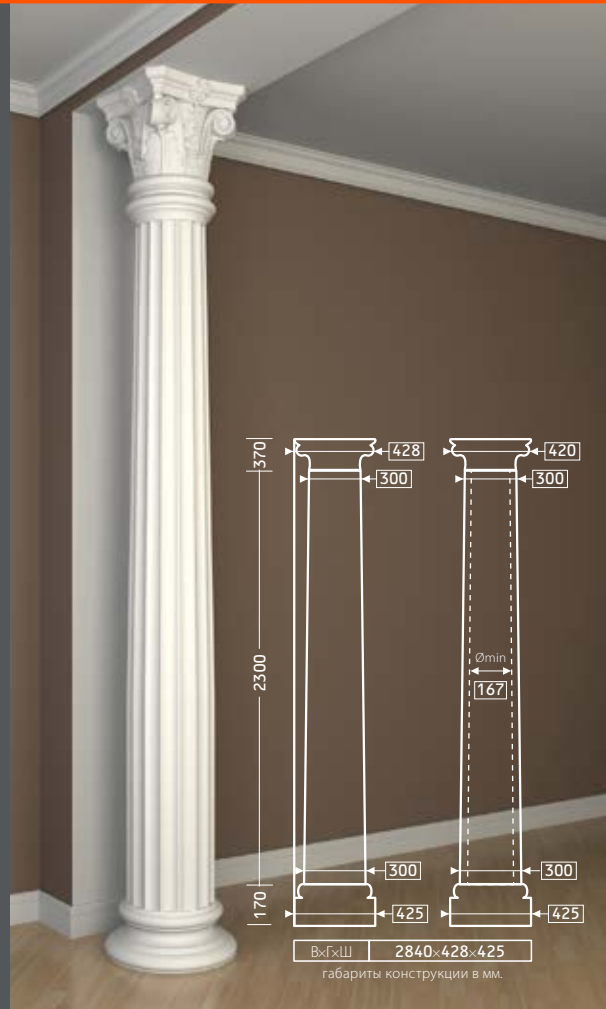

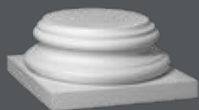
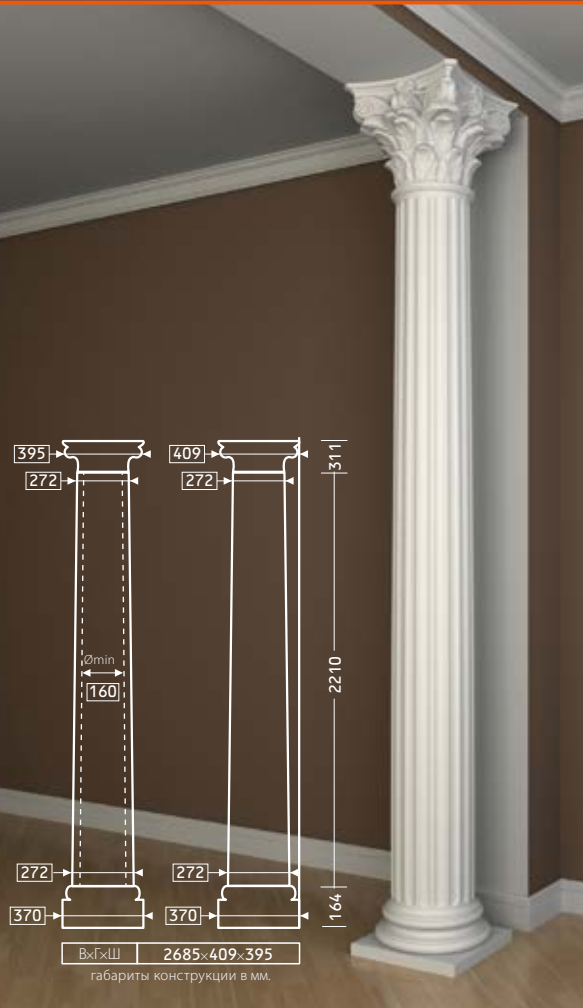
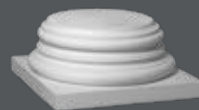
КАПИТЕЛЬ
4.11.301СТВОЛ
4.12.301БАЗА
4.13.302БАЗА
4.13.301

ВхГхШ 2685×409×395
габариты конструкции в мм.

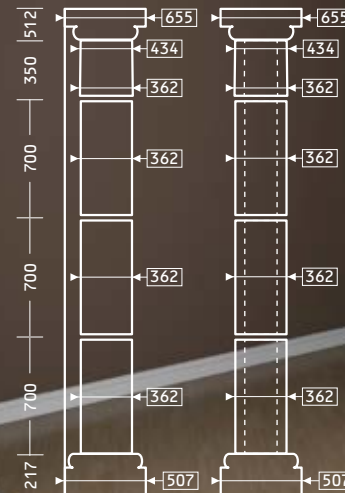
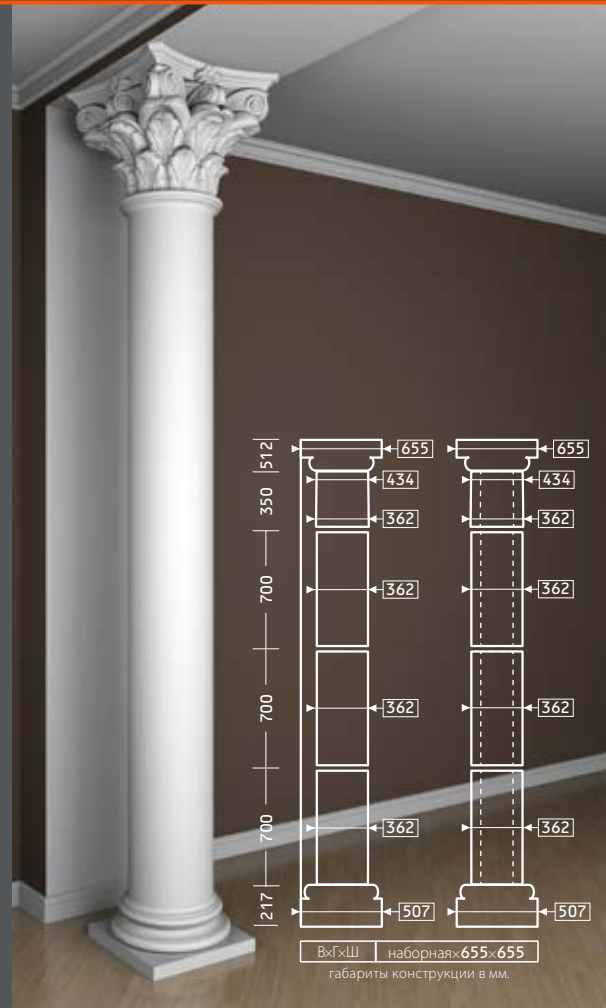
КАПИТЕЛЬ
4.11.302СТВОЛ
4.12.001БАЗА
4.13.002СТВОЛ
4.12.002

ВхГхШ наборная 655×655
габариты конструкции в мм.

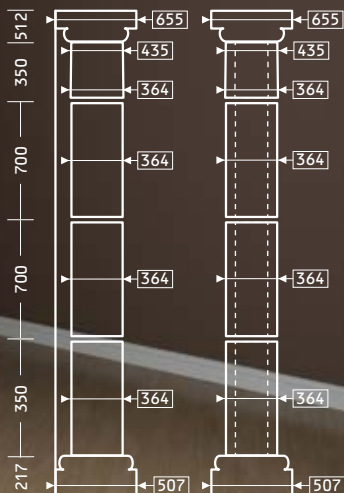
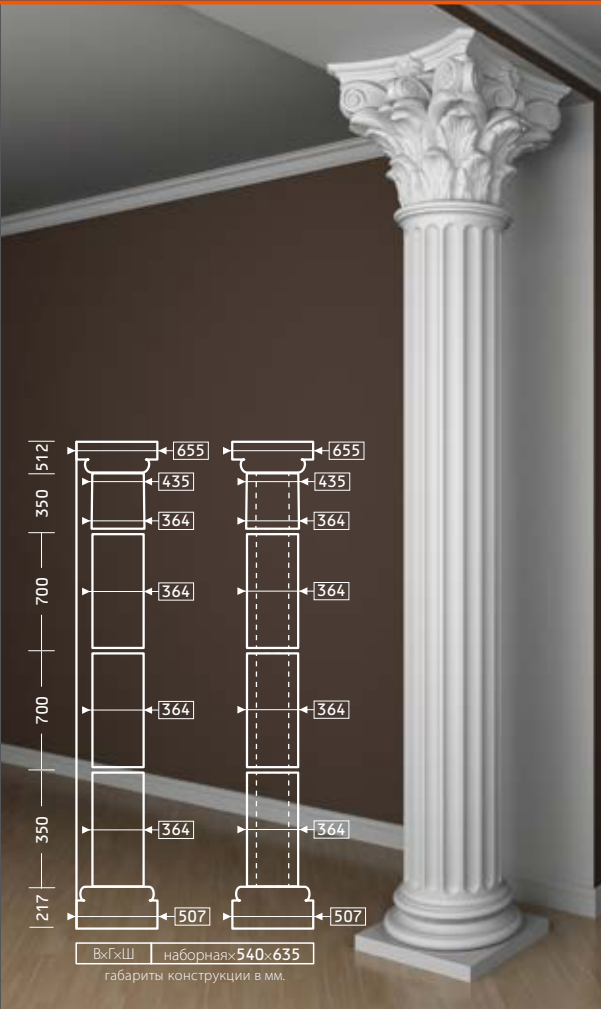
КАПИТЕЛЬ
4.11.302СТВОЛ
4.12.003БАЗА
4.13.002СТВОЛ
4.12.004СТВОЛ
4.12.005

ВхГхШ наборная 540×635
габариты конструкции в мм.

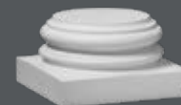
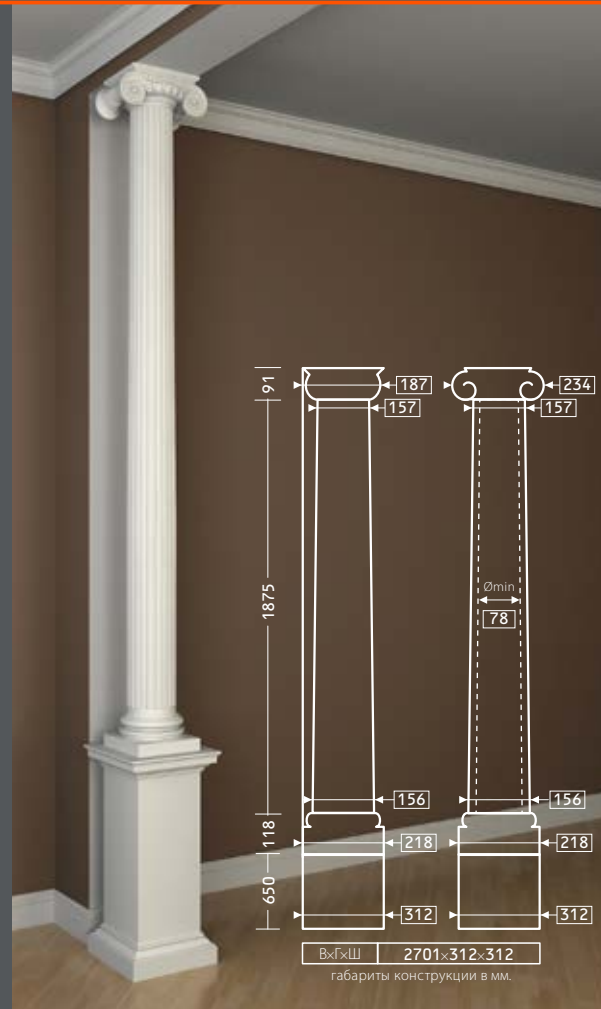
КАПИТЕЛЬ
1.11.009СТВОЛ
1.12.070БАЗА
1.13.800ПЬЕДЕСТАЛ
1.14.002

ВхГхШ 2701×312×312
габариты конструкции в мм.