

Filterelement Filter element

Material-Nr.: <i>Material no.:</i>	1.0100H10XL-A00-0-M
Bezeichnung: <i>Designation:</i>	1.0100 PWR10-A00-0-M
Filterfeinheit¹: <i>Filtration grade¹:</i>	10 µm
Filtrationsquotient¹: <i>Filtration ratio¹:</i>	β10(c) = 200 / β11(c) = 1000 (ISO 16889)
Filtermaterial¹: <i>Filter media¹:</i>	Glasfasermaterial PWR / H..XL <i>glass fiber material PWR / H..XL</i>
Kollapsdruckbeständigkeit bar [psi]: <i>Collapse pressure rating bar [psi]:</i>	30 [435]
Temperaturbeständigkeit °C [°F]: <i>Temperature rating °C [°F]:</i>	-40...100 [-40...212]
Bypass Öffnungsdruck bar [psi]: <i>Bypass cracking pressure bar [psi]:</i>	∅
Dichtungswerkstoff: <i>Sealing material:</i>	NBR
Abmessungen mm [inch]: <i>Dimensions mm [inch]:</i>	
OD =	60,0 [2.4]
ID =	32,3 [1.3]
L =	250,0 [9.8]
Gewicht kg [lbs]: <i>Weight kg [lbs]:</i>	0,4 [0.9]

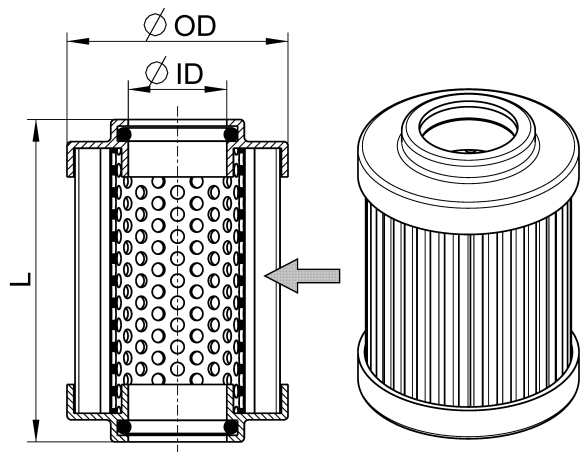

Vereinfachte Darstellung
The drawing shown is a simplistic representation