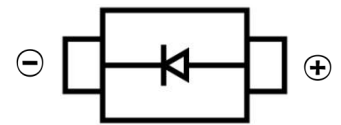

SCHOTTKY BARRIER DIODE
FEATURES

- Small Surface Mount device
- Low power loss, high efficiency
- High forward surge current capability
- For use in low voltage, high frequency inverters, free wheeling, and polarity protection applications

SMAF

MECHANICAL DATA

- Case: SMAF
- Case Material: Molded Plastic. UL flammability
- Classification Rating: 94V-0
- Moisture Sensitivity: Level 1 per J-STD-020
- Weight: 0.027 grams (approximate)

MAXIMUM RATINGS (T_A = 25°C unless otherwise noted)

Parameter	Symbol	Value	Unit
Repetitive peak reverse voltage	V _{RRM}	40	V
DC Reverse Voltage	V _R	40	V
RMS Reverse Voltage	V _{RMS}	28	V
Non-Repetitive Peak Forward Surge Current @ t = 8.3 ms	I _{FSM}	150	A
Mean rectifying current	I _F	5	A
Thermal Resistance From Junction To Ambient	R _{θJA}	50	°C/W
Junction Temperature	T _J	125	°C
Storage Temperature	T _{STG}	-55 ~+150	°C

ELECTRICAL CHARACTERISTICS (T_A = 25°C unless otherwise specified)

Parameter	Symbol	Min	Max	Unit	Conditions
Forward voltage	V _F		0.55	V	I _F =5A
Reverse current T=25°C	I _R		0.50	mA	V _R =40V
Reverse current T=100°C	I _R		20	mA	V _R =40V
Junction capacitance	C _J		200	pF	V _R =4V, f=1MH

SCHOTTKY BARRIER DIODE

Typical Characteristics

Fig.1 Forward Current Derating Curve

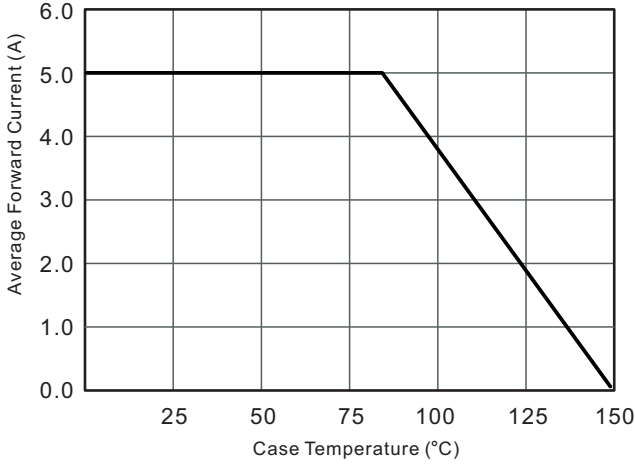

Fig.2 Typical Reverse Characteristics

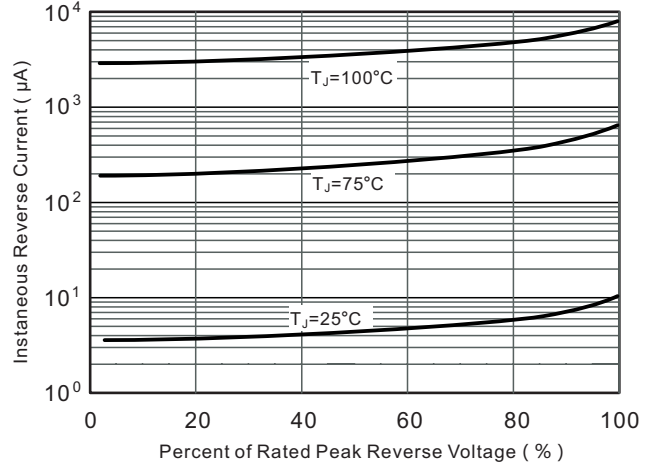

Fig.3 Typical Forward Characteristic

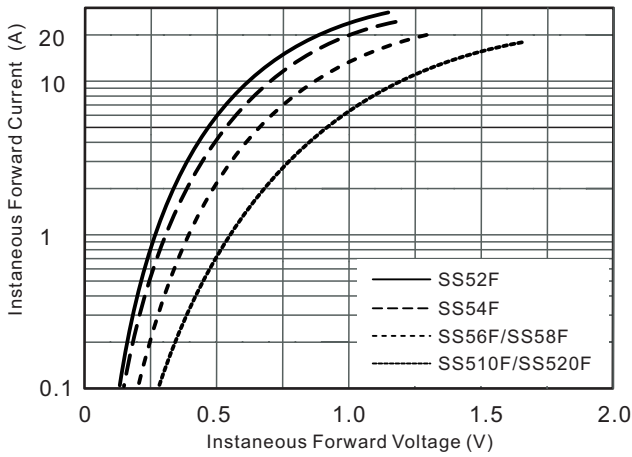

Fig.4 Typical Junction Capacitance

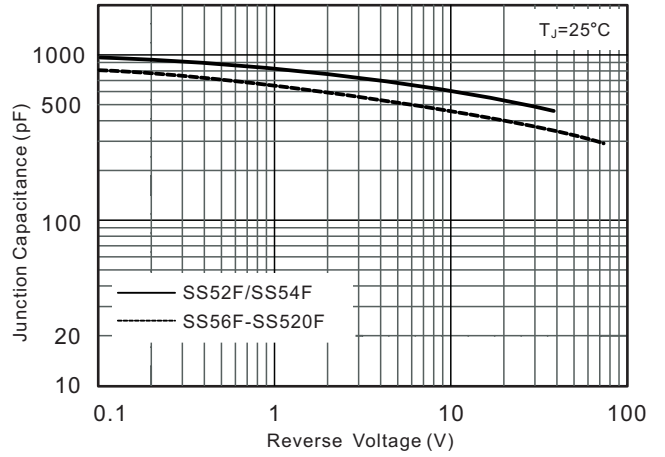

Fig.5 Maximum Non-Repetitive Peak Forward Surge Current

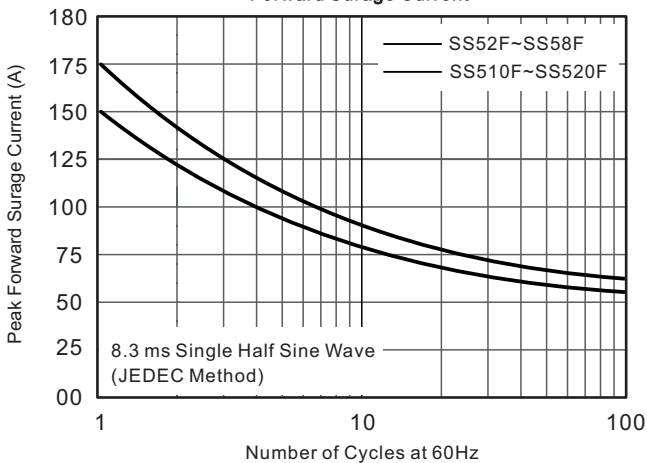
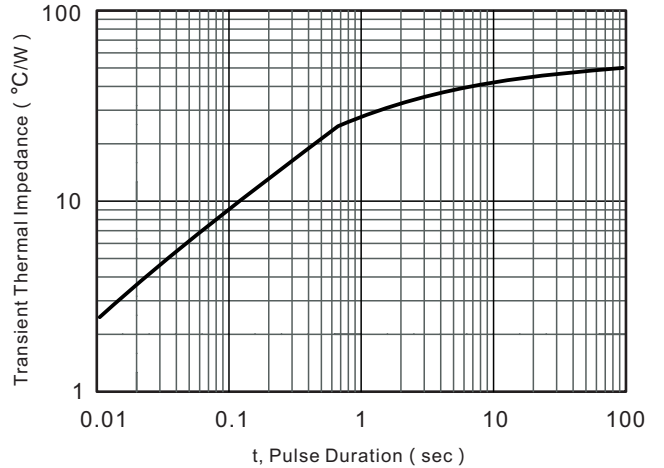
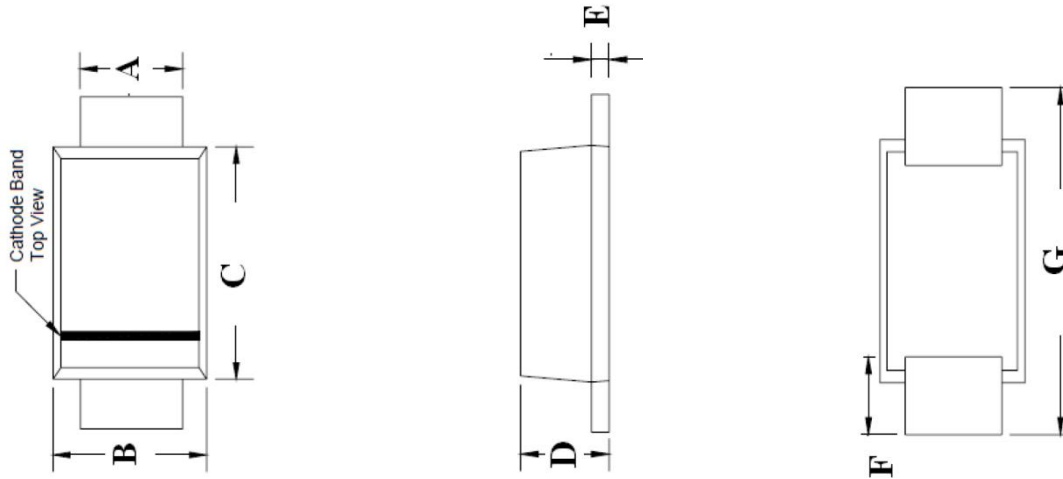
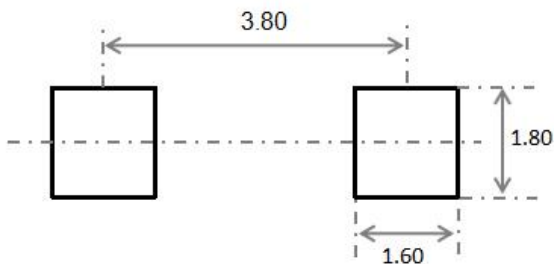

Fig.6- Typical Transient Thermal Impedance



SCHOTTKY BARRIER DIODE
SMAF Package Outline Dimensions

Symbol	Dimensions In Millimeters		Dimensions In Inches	
	Min.	Max.	Min.	Max.
A	1.30	1.60	0.051	0.063
B	2.40	2.80	0.094	0.110
C	3.25	3.65	0.128	0.144
D	1.10	1.40	0.043	0.055
E	0.15	0.25	0.006	0.010
F	0.70	1.20	0.028	0.047
G	4.40	4.90	0.173	0.193

SMAF Suggested Pad Layout

Note:

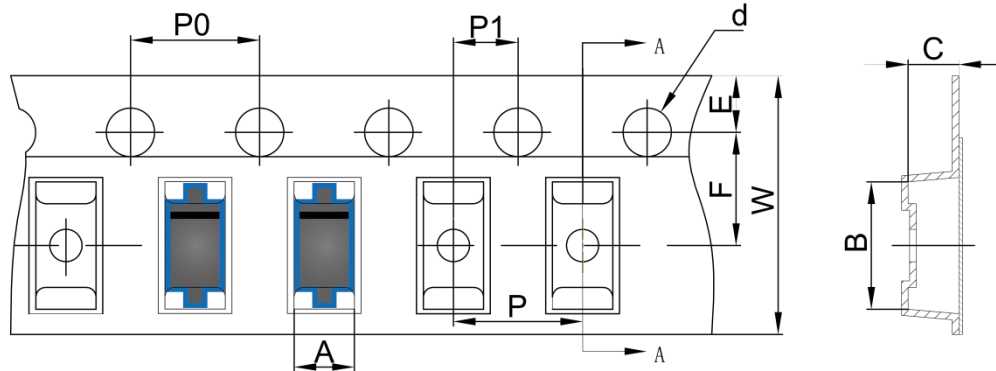
1. Controlling dimension: in millimeters
2. General tolerance: $\pm 0.05\text{mm}$
3. The pad layout is for reference purposes only

SCHOTTKY BARRIER DIODE
SMAF Tape and Reel
SMAF Embossed Carrier Tape

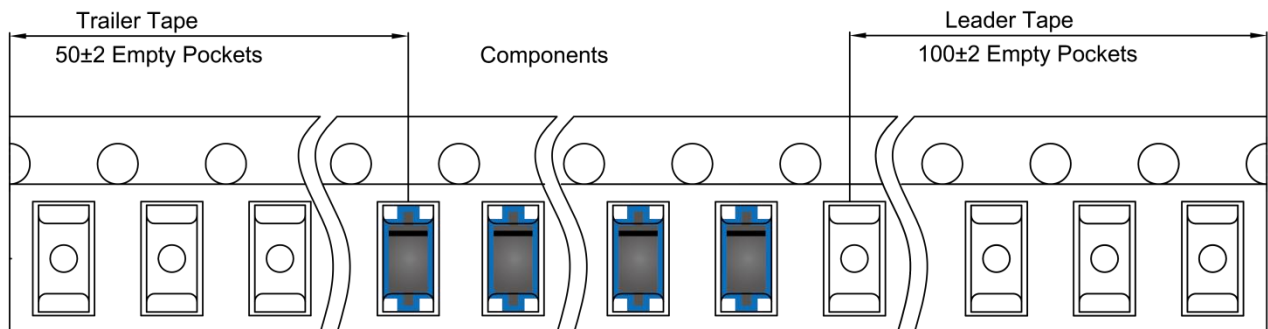
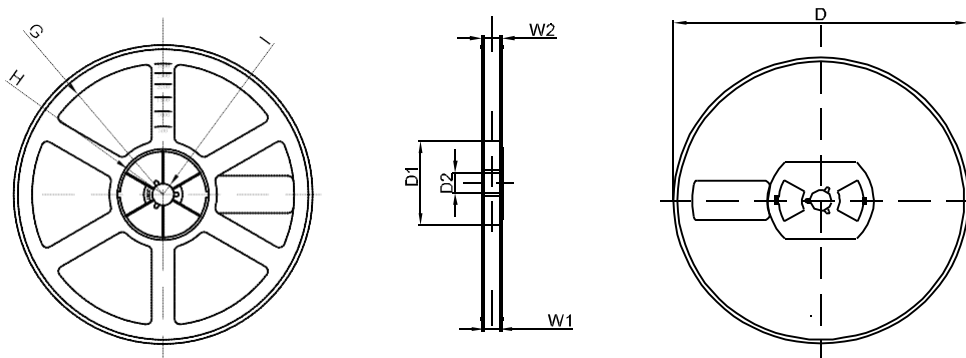
DIMENSIONS ARE IN MILLIMETER										
TYPE	A	B	C	d	E	F	P0	P	P1	W
SMAF	2.79	5.35	1.48	Ø1.50	1.75	5.50	4.00	4.00	2.00	12.00
TOLERANCE	±0.1	±0.1	±0.1	±0.1	±0.1	±0.1	±0.1	±0.1	±0.1	±0.1

SMAF Tape Leader and Trailer

SMAF Reel

DIMENSIONS ARE IN MILLIMETER								
REEL OPTION	D	D1	D2	G	H	I	W1	W2
7" DIA	Ø178	54.40	13.00	R78	R25.60	R6.50	12.40	17.60
TOLERANCE	±2	±1	±1	±1	±1	±1	±1	±1