

# M-SR...type Plug In Check Valve



## M-SR...1XJ...type

Sizes 8, 10, 15, 20, 25, 30  
Max. Working Pressure: 315 bar  
Max. Flow: 400 L/min

### Contents

Configuration	02
Specifications	02
Technical data	03
Characteristic curves	03-04
Cavity dimensions:	05-06

### Features

- Installation in manifold blocks
- Leakage-free closure in one direction
- Various cracking pressures, optional

### Symbol

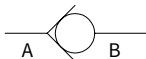

# Configuration

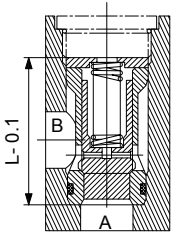

Right angled check valve cartridge

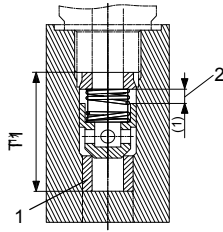

Straight line check valve cartridge  
 1-Seat frozen in at -60 °C  
 2-Stroke  
 (1)-Dimensions below

Size	L
8	36.3
10	39.3
15	45.8
20	55.3
25	74.3
30	83.3

# Specifications

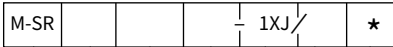

Plug in check valve

- size 8 = 8
- size 10 =10
- size 15 =15
- size 20 =20
- size 25 =25
- size 30 =30

Right angled check valve cartridge =KE  
 Straight line check valve cartridge =KD

Further details in clear text

No code = NBR seals  
 V = FKM seals

1XJ = Series 10J to 19J  
 (10J to 19J: unchanged installation and connection dimensions)

- 00= Without spring (not with straight line check valve)
- 02= Crack pressure 0.2bar
- 05= Crack pressure 0.5bar
- 15= Crack pressure 1.5bar
- 30= Crack pressure 3bar
- 50= Crack pressure 5bar

# Technical data

Max. operating pressure	bar	315					
Crack pressure	bar	see characteristic curves					
Max. flow-rate	L/min	see characteristic curves					
Viscosity range	mm <sup>2</sup> /s	2.8 to 380					
Fluid temperature range	°C	-30 to +80 (NBR seal)					
		-20 to +80 (FKM seal)					
Fluid		Mineral oil suit for NBR and FKM seal					
		Phosphate ester for FKM seal					
Degree of contamination		Maximum permissible degree of fluid contamination: Class 9. NAS 1638 or 20/18/15, ISO4406					
Size		8	10	15	20	25	30
Weight: Right angled check valve cartridge	Kg	0.03	0.05	0.08	0.14	0.32	0.47
	Straight line check valve cartridge	Kg	0.05	0.05	0.1	0.2	0.25

01

## Characteristic curves (Measured at t=40°C ± 5°C, using HLP46)

Right angled plug in check valve

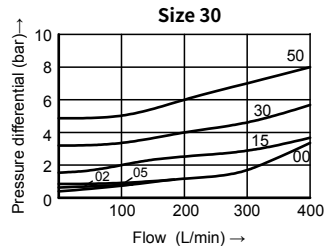
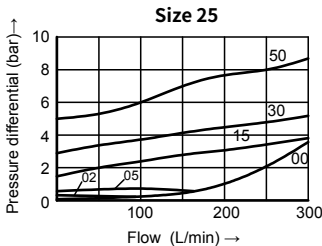
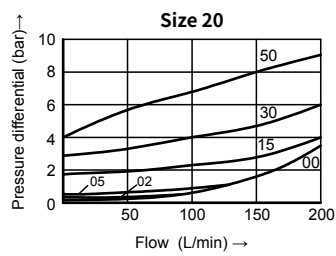
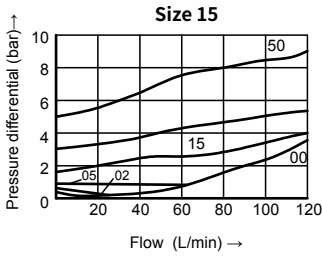
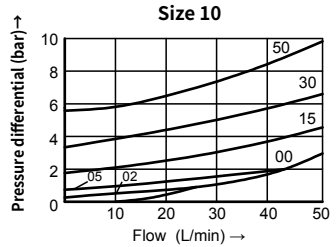
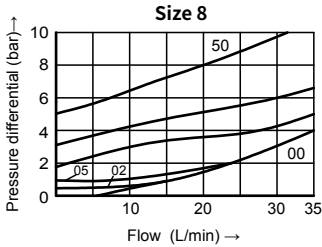

**Characteristic curves** (Measured at  $t=40^{\circ}\text{C} \pm 5^{\circ}\text{C}$ , using HLP46)

Straight line plug in check valve

01

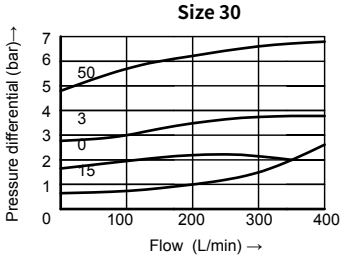
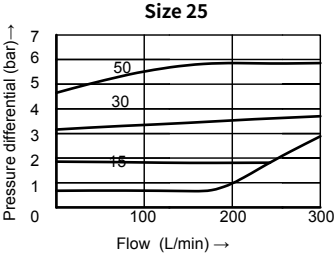
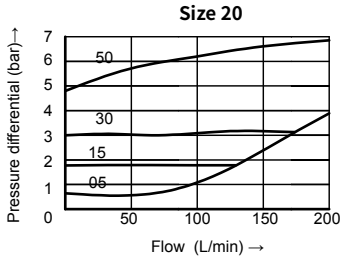
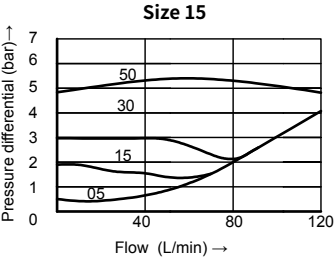
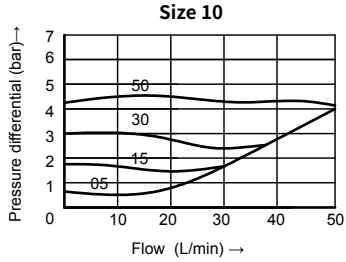
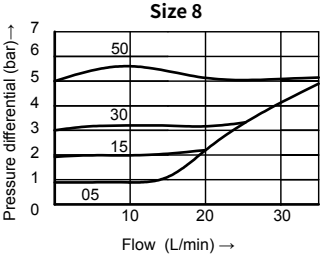

# Cavity dimensions:

(Dimensions in mm)

Right angled plug in check valve

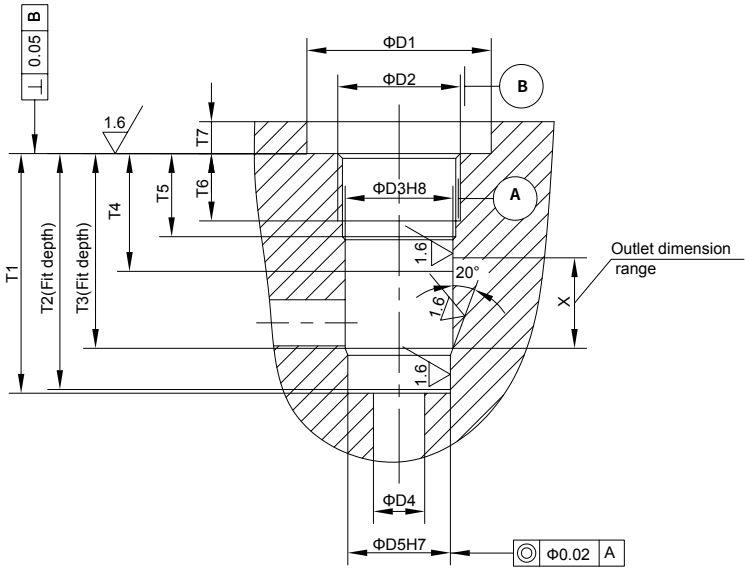

Size	Plug screw	Gasket	ΦD1	D2	ΦD3H8	ΦD4	ΦD5H7	T1+0.2/0	T2	T3	T4	T5	T6	T7	X
8	M18×1.5	JB982	27	M18×1.5	14	8	13	47.5	46.5	37.5	23	17	14	7	18
10	M22×1.5		32	M22×1.5	18	10	17	52.5	51.5	42.5	25	19	16	7	19
15	M27×2		37	M27×2	24	15	22	61	60	49	28	22	18	8	24
20	M33×2		44	M33×2	30	20	28	72.5	71	57.5	28	24	20	8	30
25	M42×2		42	M42×2	38	25	36	93.5	91	75.5	32	27	22	9	43
30	M48×2		48	M48×2	44	30	42	104.5	102	84.5	38	30	24	9	48

## Inserted hole dimensions:

(Dimensions in mm)

Straight line plug in check valve

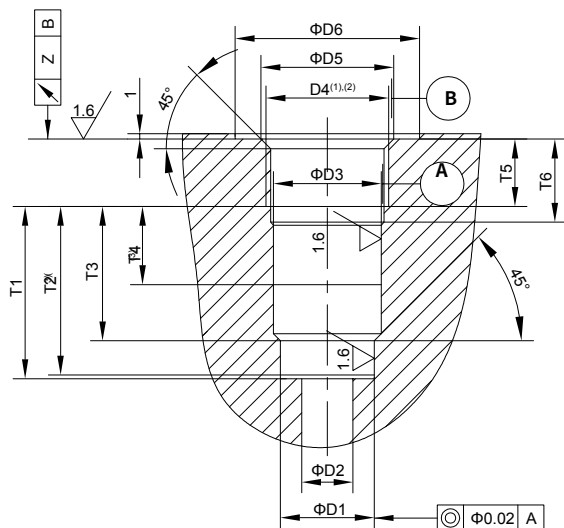

Size	$\Phi D1_{H7}$	$\Phi D2$	$\Phi D3_{H8}$	$\Phi D4^{(1)}$	$\Phi D5^{\pm 0.1 (1)}$	$D4^{(2)}$	$\Phi D5^{\pm 0.1 (2)}$	$\Phi D6$
8	13	8	14	G3/8	17.1	M18×1.5	18.4	28
10	17	10	18	G1/2	21.4	M22×1.5	22.4	34
15	22	15	24	G3/4	26.8	M27×1.5	27.4	42
20	28	20	30	G1	33.8	M33×2	33.5	47
25	36	25	38	G1 1/4	42.5	M42×2	42.5	58
30	48	30	44	G1 1/2	48.5	M48×2	48.5	65

Size	$T1_{0, -0.1}$	T2	T3	T4	T5	T6	Z	Poppet stroke
8	32.8	30.8	22.8	18	12	16	0.05	4
10	38.8	36.8	28.8	21	14	19	0.05	4
15	48.4	46.4	36.4	27	16	21	0.05	5
20	59	57	44	29	18	24	0.05	5
25	73	71	55	39	20	26	0.1	7
30	83	81	63	42	22	28	0.1	7