

M-SED 10 type Solenoid Ball Valve



M-SED10...1XJ...type

Size 10
Max. Working Pressure: 315 bar
Max. Flow: 40 L/min

Contents

Function and configuration	02
Symbols	03
Specification	03
Technical data	04
Electrical data	04
Characteristic curves	05
Unit dimensions	06-07

Features

- Direct operated directional ball with solenoid actuation
- Mounting face as per DIN24 340 A ISO 4401 and CETOP-RP 121H
- Closed port is leak-free isolated
- keep switch flexibility under high pressure
- Pressure-tight chamber does not need to be opened for a change of the coil
- Solenoid coil can be rotated through 90°
- With concealed manual override, optional

Function and configuration

M-SED10 3/2 directional poppet valve

M-SED10 type valve is direct operated directional poppet valves with solenoid actuation. They control the start, stop and direction of flow. The valve consists of valve housing (1), the solenoid (2), the valve seat (7) and (11) and the control spool (4).

The manual override (6) allows the valve to be operated without solenoid energization.

The initial position of the valve (normally open "UK" or normally closed "CK") is determined by the arrangement of the spring (5). The chamber (3) behind the control spool (4) is connected to port P and sealed against port T. Thus, the valve is pressure-compensated in relation to the actuating forces (solenoid and spring).

By the control spool (4), the port P, A and T can be loaded with maximum operating pressure (350bar) and the flow can be directed in both directions.

In the initial position, the control spool (4) is pressed onto the seat (11) by the spring (5), it is pressed onto the seat (7) by the solenoid (2) in spool position. The flow is blocked.

M-4SED10 4/2 directional poppet valve

With the help of a sandwich plate, the Plus-1 plate, under the 3/2 directional poppet valves, the function of a 4/2 directional poppet valve is achieved.

Function of the Plus-1 plate

Initial position:

The main valve is not actuated. The spring (5) holds the control spool (4) on the seat (11). Port P is blocked and A is connected to T. Apart from that, one control line is connected from A to the large area of the control spool (8), which is thus unloaded to the tank. The pressure applied via P now pushes the ball (9) onto the seat (10). Now, P is connected to B, and A to T.

Transition position:

When the main valve is actuated, the control spool (4) is shifted against the spring (5) and pressed onto the seat (7). During this, port T is blocked, P, A and B is briefly connected to each other.

Spool position:

P is connected to A. As the pump pressure acts via A on the large area of the control spool (8), the ball (9) is pressed onto the seat (12). Thus, B is connected to T, and P to A. The ball (9) in the Plus-1 plate has a "positive spool overlap".

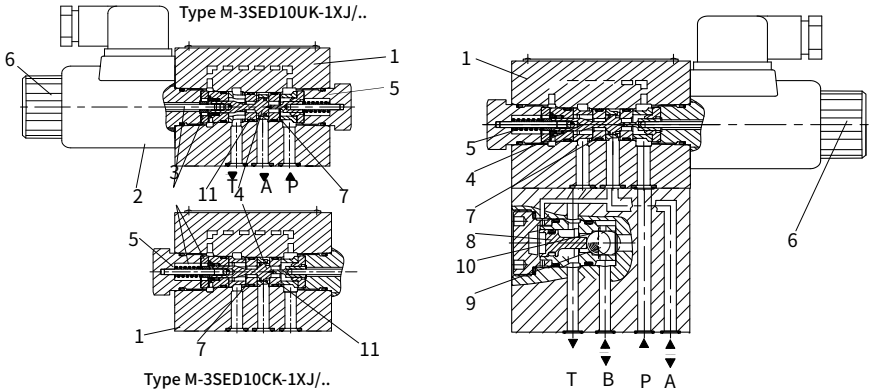

Throttle insert:

The use of a throttle insert is required, if, due to the operating conditions, flows are to be expected during the switching procedure, which are higher than the started maximum performance limits of the valve. The throttle is inserted into port P of the valve.

Cartridge check valve:

The cartridge check valve allows free flow from P to A and provides leak-free closed from A to P. The cartridge check valve is inserted into port P of the valve.

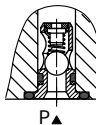

Spool symbols

Type M-3SED10UK-1XJ/..

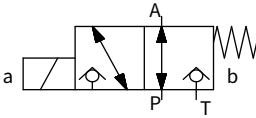

Type M-4SED10D-1XJ/..

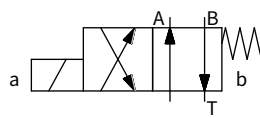

Type M-3SED10UK-1XJ/..

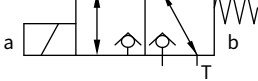

Type M-4SED10Y-1XJ/..

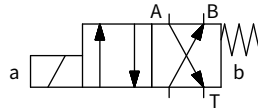

Specification

	M	—	SED	10	—	1XJ	/	350	C		N	/		
3 service port	= 3													
4 service port	= 4													
Solenoid ball valve														No code = NBR seals V = FKM seals
Size 10	= 10													
Spool symbols														
Series 10J to 19J (10J to 19J: unchanged installation and connection dimensions)	= 1XJ													No code = Without cartridge check valve, without throttle insert P = With cartridge check valve B12 = Throttle Φ 1.2 mm B15 = Throttle Φ 1.5 mm B18 = Throttle Φ 1.8 mm B20 = Throttle Φ 2.0 mm B22 = Throttle Φ 2.2 mm
Operating pressure 350 bar	= 350													
Wet-pin solenoid with detachable coil	= C													K4 = Din4365 sockets without plug Z4 = Square plug Z5L = Square plug with lamps
12VDC	= G12													
24VDC	= G24													
110VDC	= G110													
205VDC	= G205													
220VDC	= G220													
Plug rectification 110V	= W110R													
Plug rectification 220V	= W220R													
With manual override	= N9													

Technical data

Installation position		Optional	
Environment temperature		°C	-30 to +50 (NBR seal) -20 to +50 (FKM seal)
Weight	Two tee Solenoidic directional valve	Kg	2.6
	Two four-way Solenoidic directional valve	Kg	3.9
Max operation pressure		bar	350
Max flow		L/min	40
Hydraulic fluid		Mineral oil suitable for NBR and FKM seal Phosphate ester for FKM seal	
Fluid temperature range		°C	-30 to +80 (NBR seal) -20 to +80 (FKM seal)
Viscosity range		mm ² /s	2.8 to 500
Degree of contamination		Maximum permissible degree of fluid contamination: Class 9. NAS 1638 or 20/18/15, ISO4406	

Electrical data

Voltage type		DC		AC+ rectifier										
Voltage version		V	12, 24, 110, 205, 220		110,220 (only possible via Z5 rectifier)									
Permissible voltage(deviation)		%	+10 ~ -15											
Input power		W	30											
Continuous power-on time		Continuous												
Switching time to ISO 6403														
Pressure bar	Flow L/min	DC solenoid						AC + rectifier						
		On/ms (without oil tank pressure)				Off/ms		On/ms (without oil tank pressure)				Off/ms		
		UK	CK	D	Y	UK, CK	D, Y	UK	CK	D	Y	UK, CK	D, Y	
70	40	40	30	40	35	10	10	35	30	40	35	40	40	40
140	40	40	30	40	35	10	10	40	30	40	35	40	40	40
210	40	45	35	45	35	10	10	45	35	45	35	40	40	40
280	40	45	35	45	35	10	10	45	35	45	35	40	40	40
315	40	50	35	50	35	10	10	50	40	50	35	40	40	40
350	40	50	45	50	45	10	10	50	45	50	45	40	40	40
Note: The switching types relate to a flow of P to A and A to T. With reversed flows deviations are possible.														
Switching frequency		Cycles/h		to 15000										
IP rating as per DIN 40050		IP65												
Max coil temperature		°C		+150										

Characteristic curves

(Measured at $t=40^{\circ}\text{C} \pm 5^{\circ}\text{C}$, using HLP46)

**Δp - q_v characteristic curves
3/2 directional ball valve**

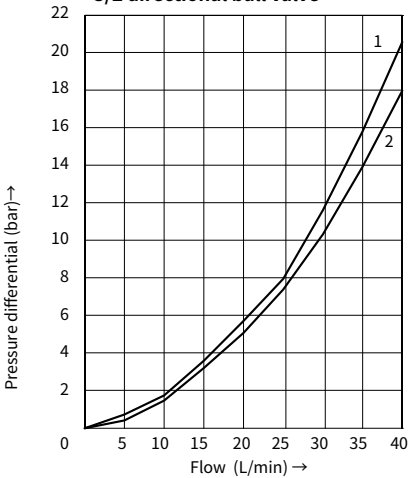

1 M-3SED6^{CK}_{UK}..., P to A

2 M-3SED6^{CK}_{UK}..., P to A

**Δp - q_v characteristic curves
4/2 directional ball valve**

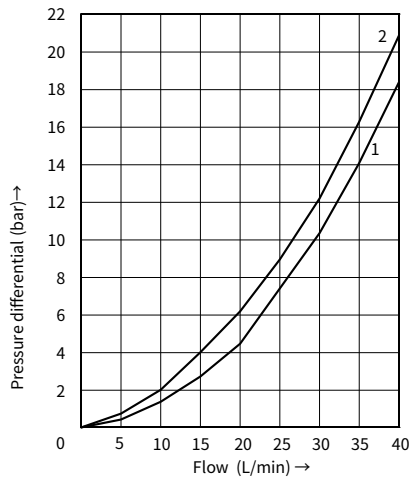

1 M-4SED6^D_V..., P to B, A to T

2 M-4SED6^D_V..., B to T, P to A

**Δp - q_v characteristic curves
Cartridge check valve**

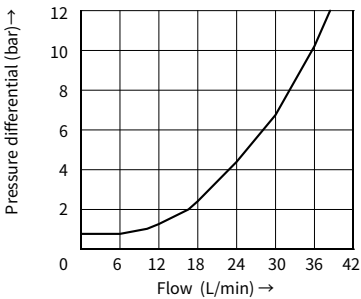

**Δp - q_v characteristic curves
Throttle insert**

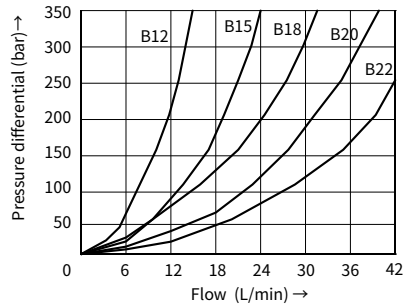

Unit dimensions

• M-3SED10^{CK}_{UK} -1XJ/...solenoid ball valve

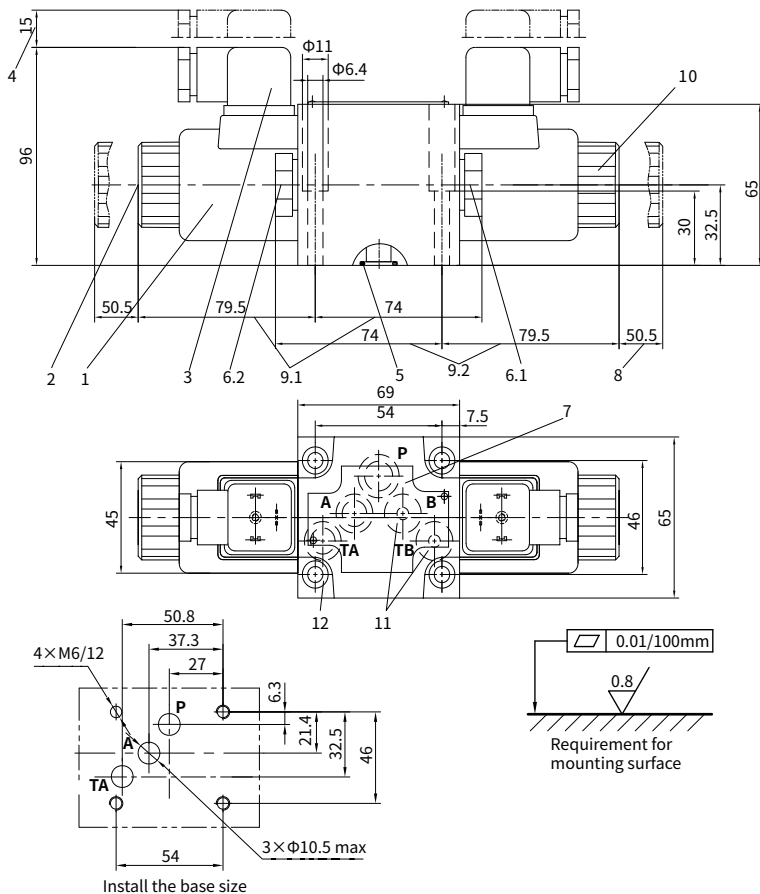

- 1 Solenoid
- 2 Manual override
- 3 Plug-in connector to DIN 43650 (rotatable 90°)
- 4 Space required to remove the Plug-in connector
- 5 O-rings 12×2 for ports A,B,TA,TB
O-rings 14×2 for port P
- 6.1 Plug for M-3SED10UK-1XJ/
- 6.2 Plug for M-3SED10CK-1XJ/
- 7 Name plate

- 8 Space required to remove the coil
 - 9.1 Total length of M-3SED10UK-1XJ/
 - 9.2 Total length of M-3SED10CK-1XJ/
 - 10 Securing nut tightening torque $M_A = 4Nm$
 - 11 Ports B and TB are a blind counterbore
 - 12 Valve fixing screws
- Internal hexagon screw: M6×40 GB/T 70.1-10.9,
tighting torque $M_A = 15.5 Nm$

