









- |   |   |   |   |
|---|---|---|---|
|  x2 |  x33 |  x14 |  x8  |
|  x2 |  x10 |  x29 |  x25 |

1



2

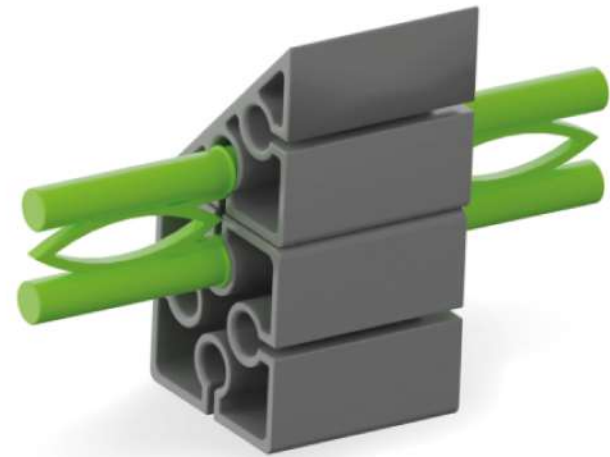
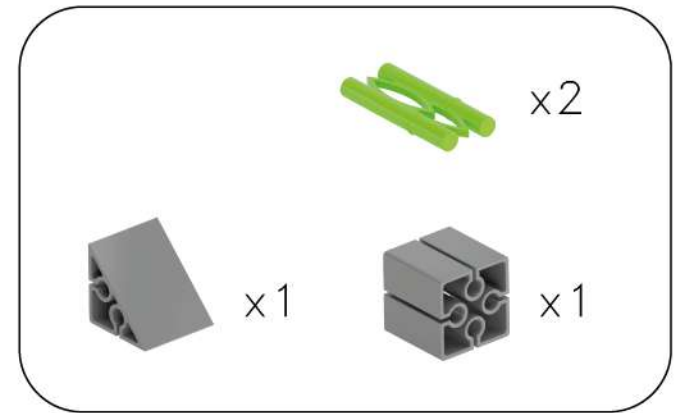
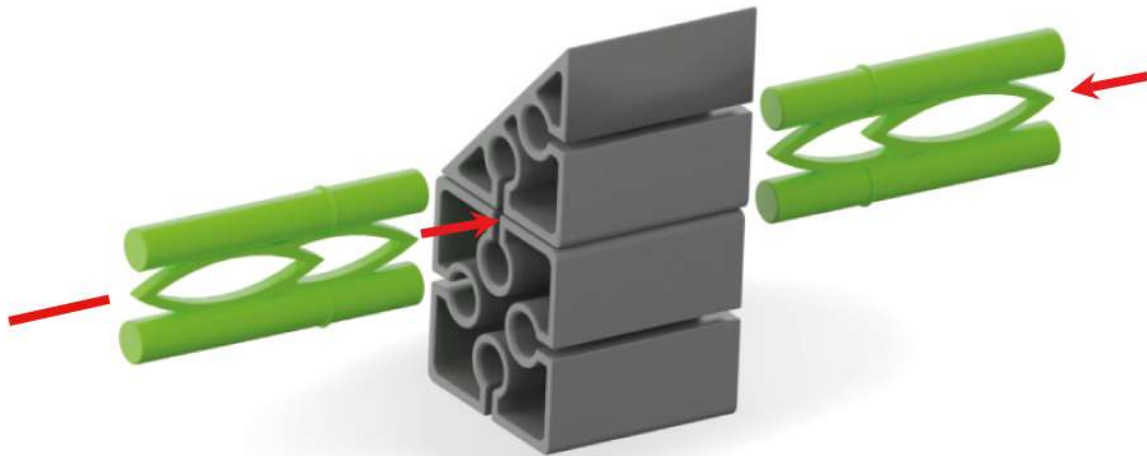
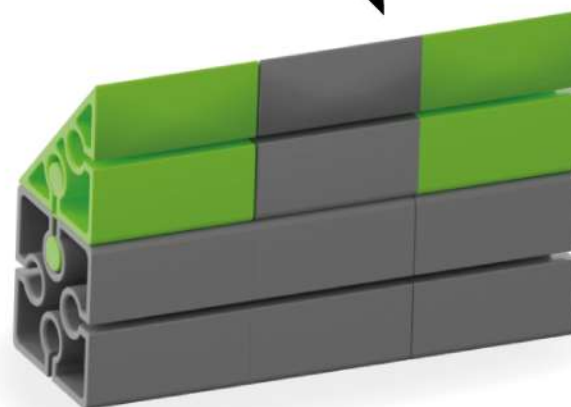
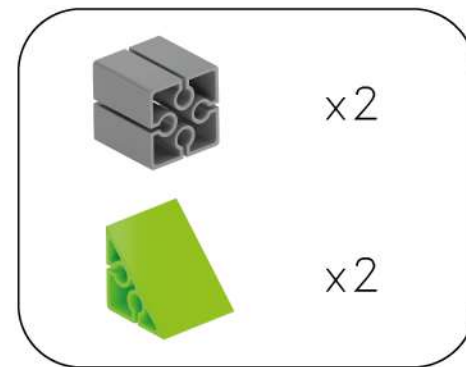

3

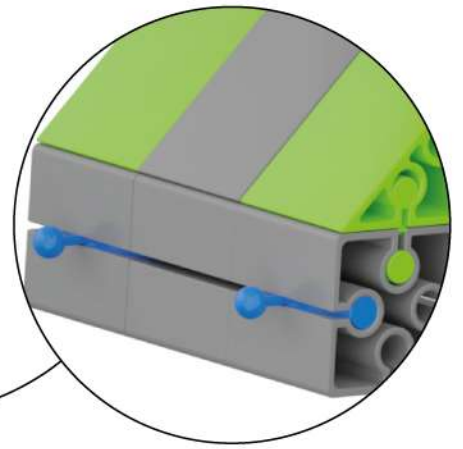
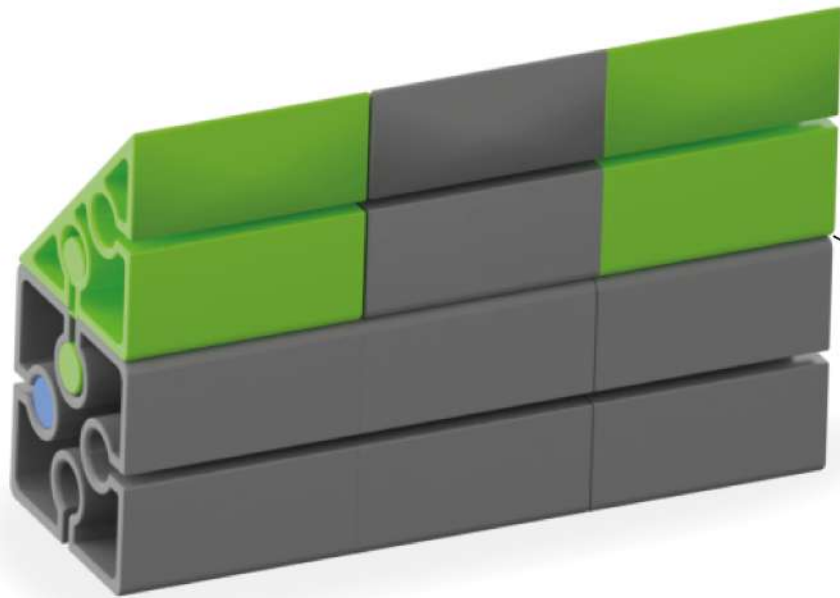
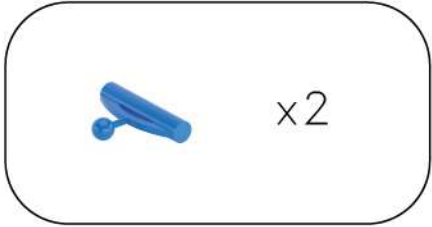
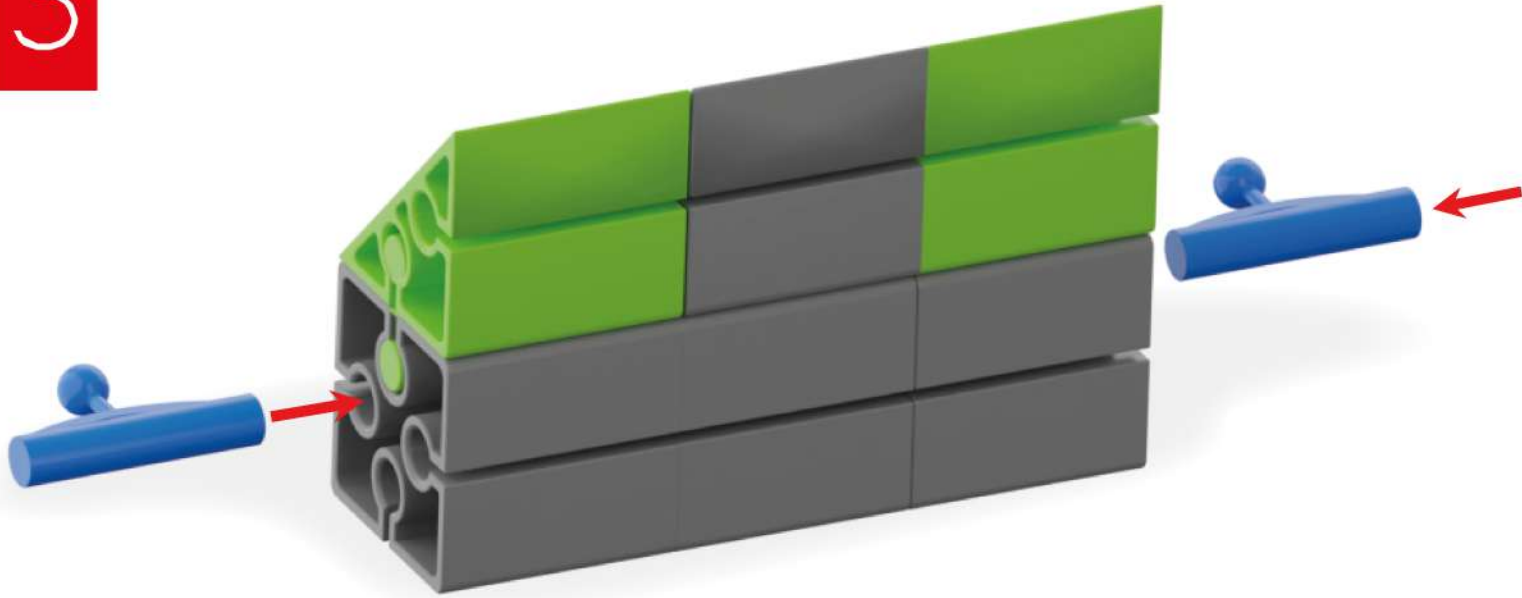

4

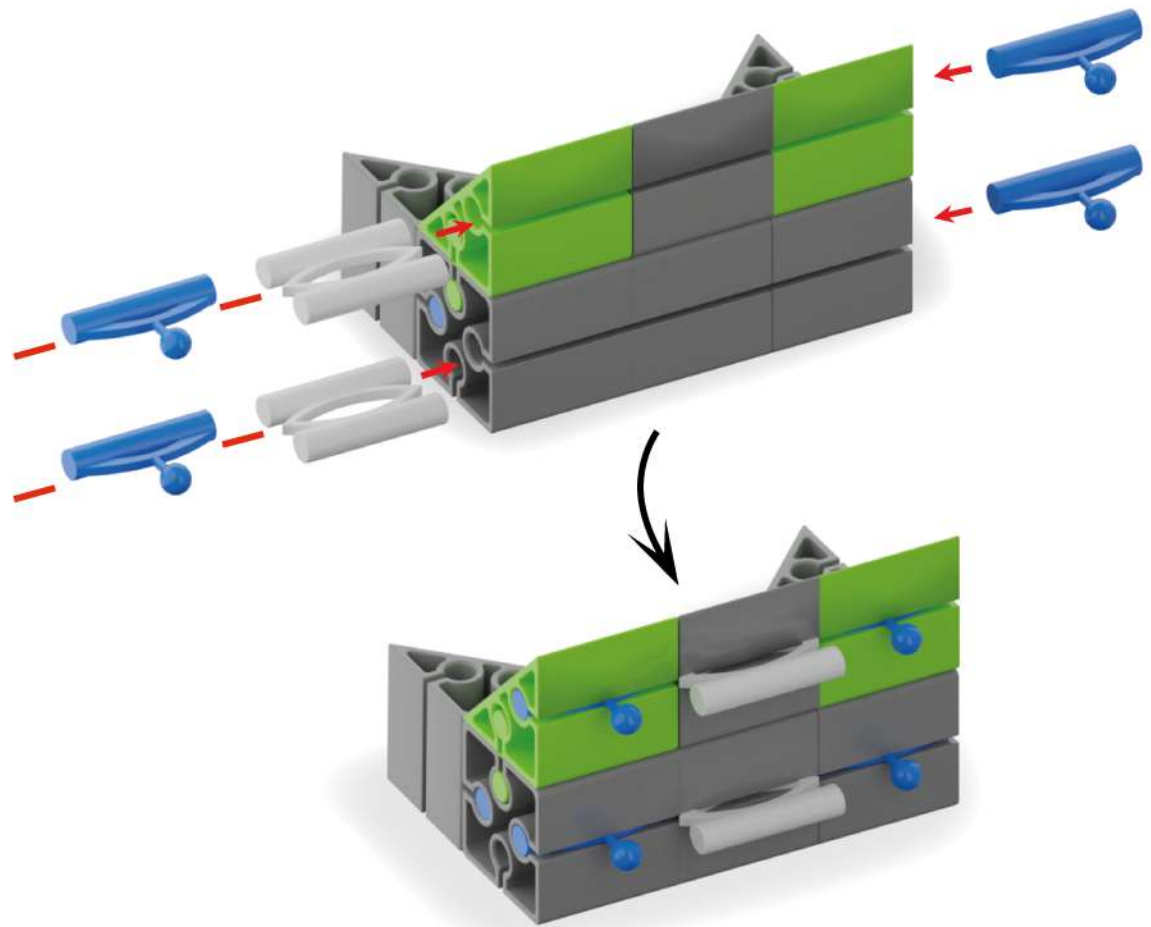
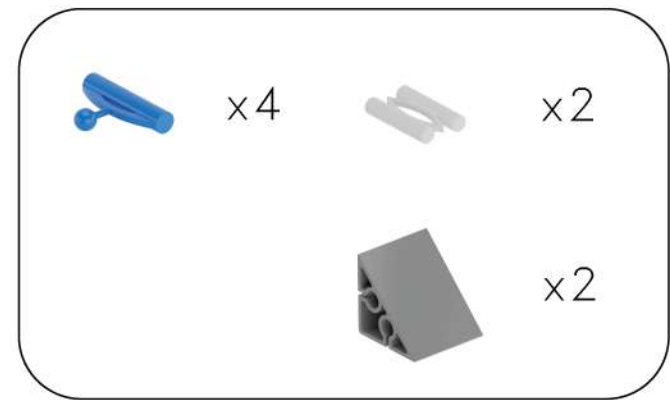
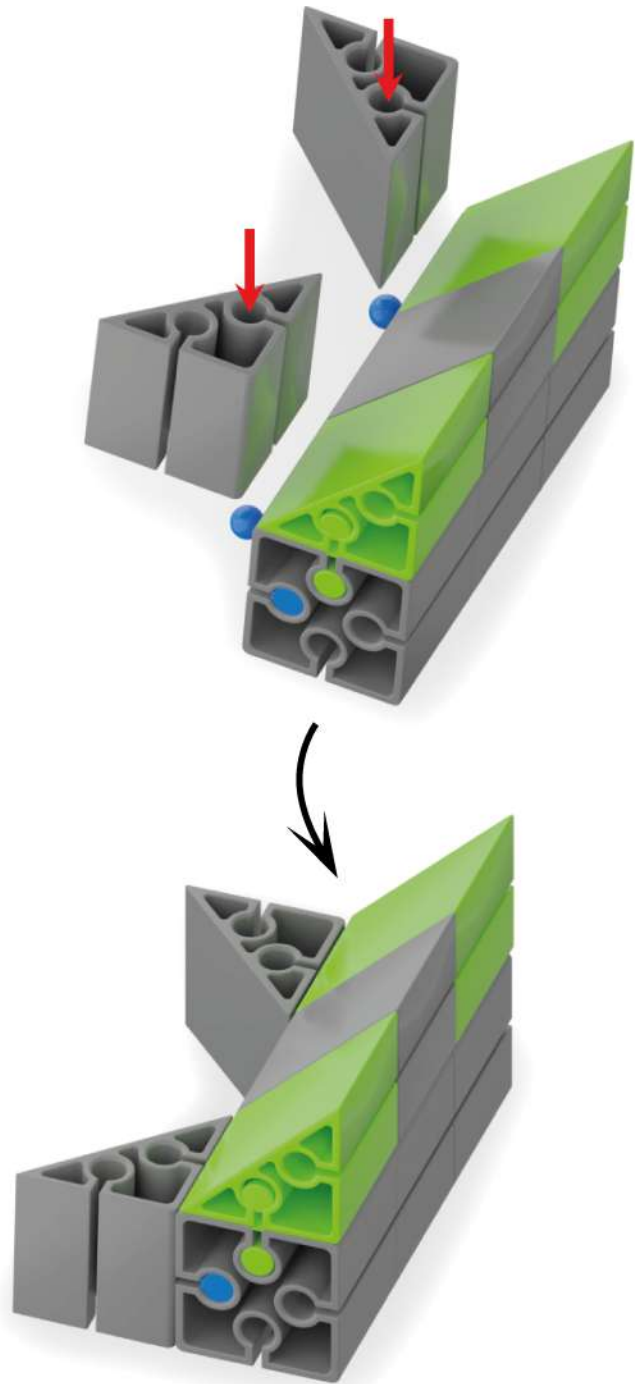

5

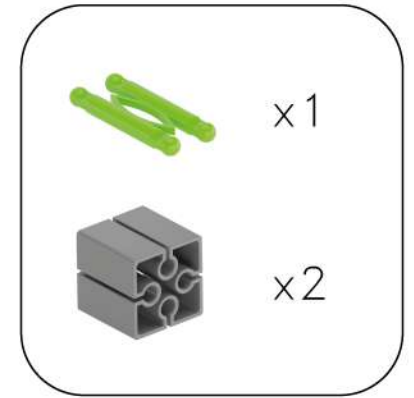
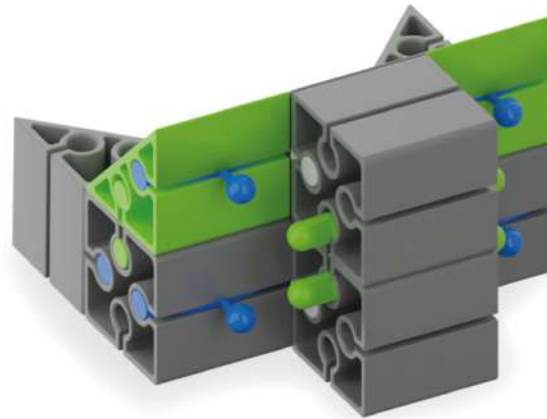
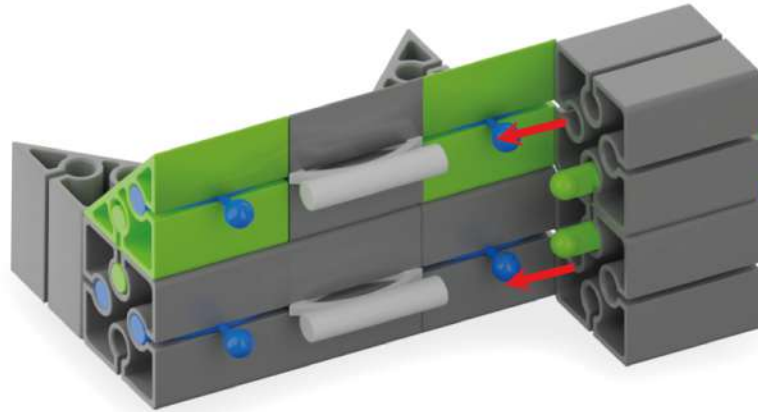
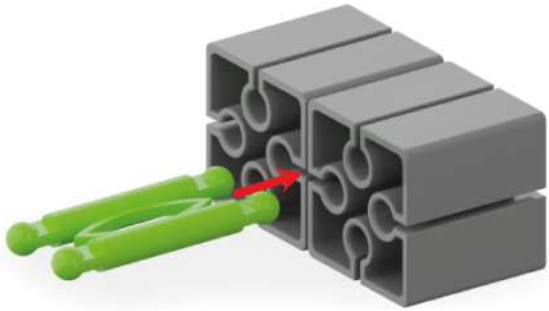

6

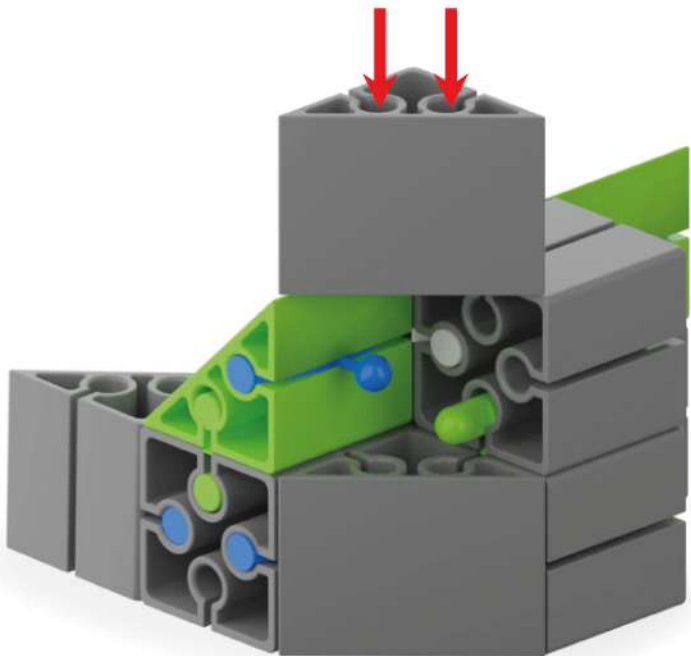
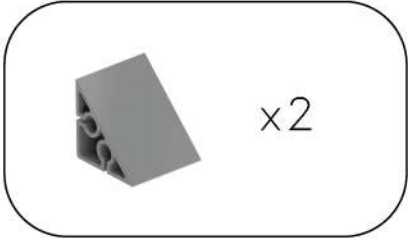
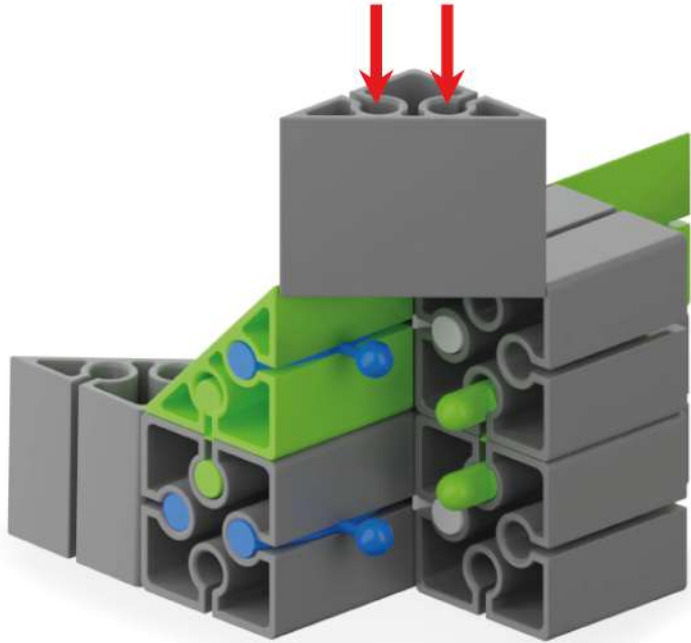

7

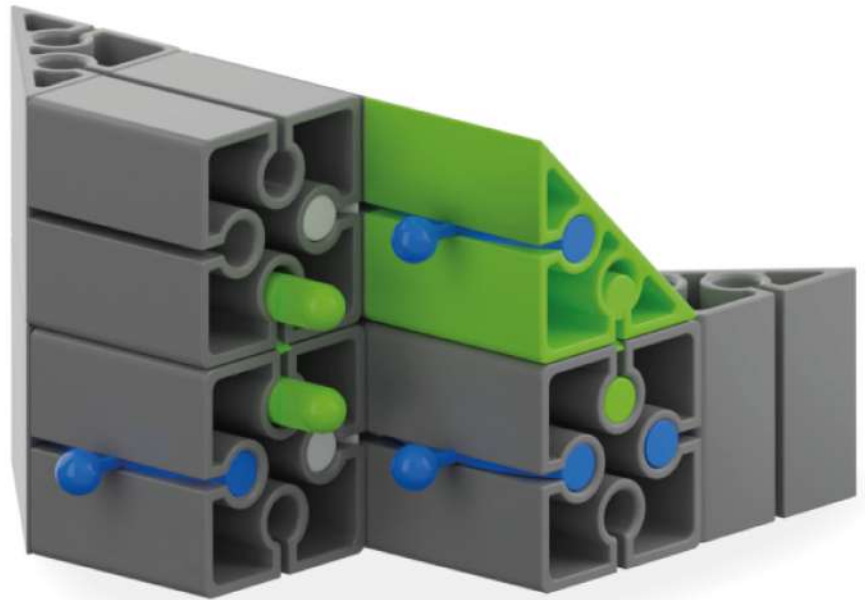
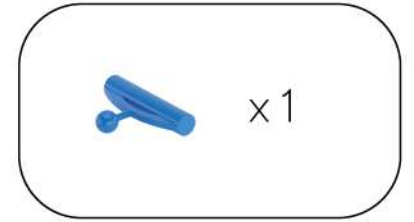
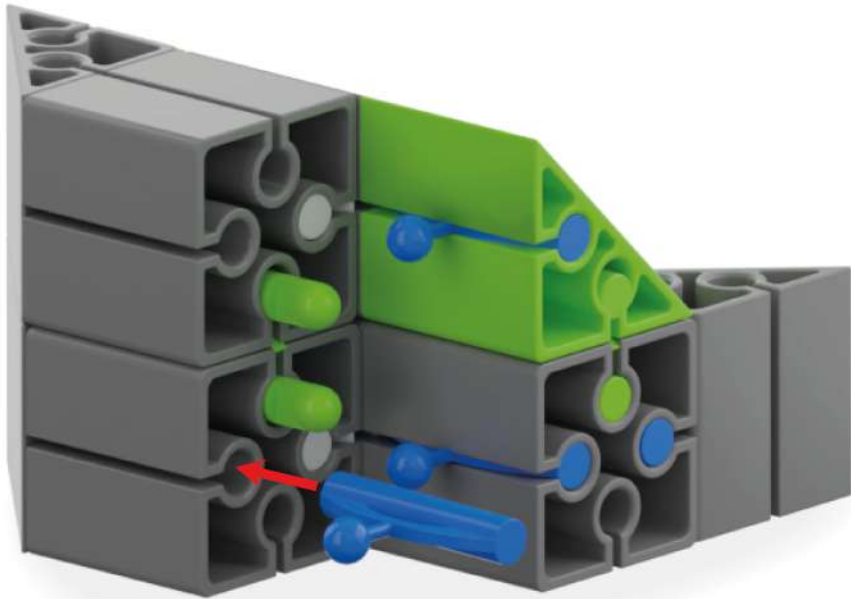





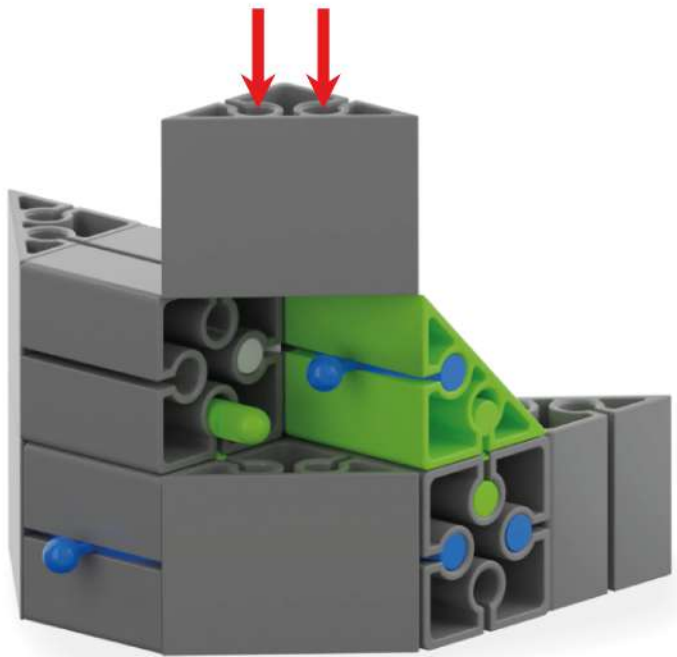
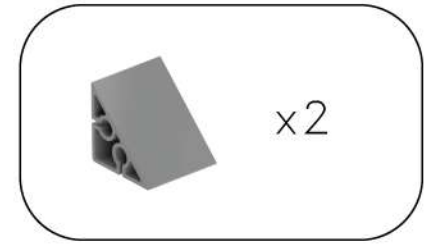
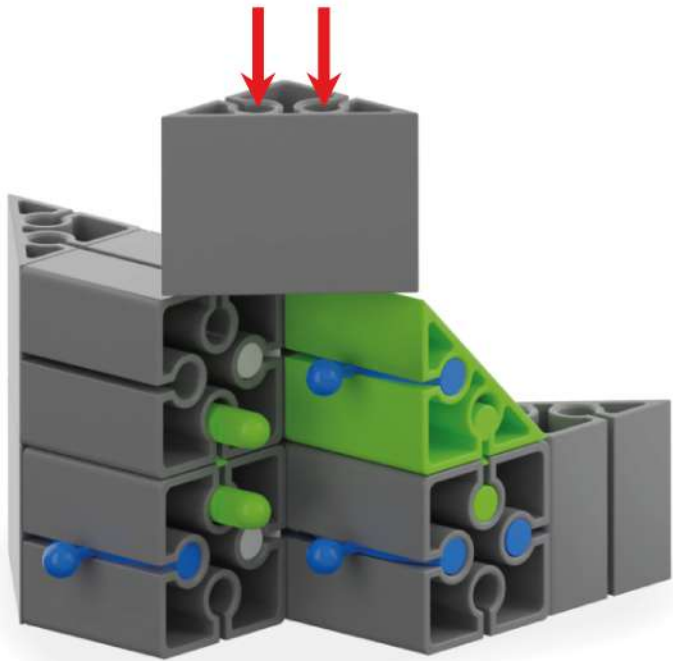

8

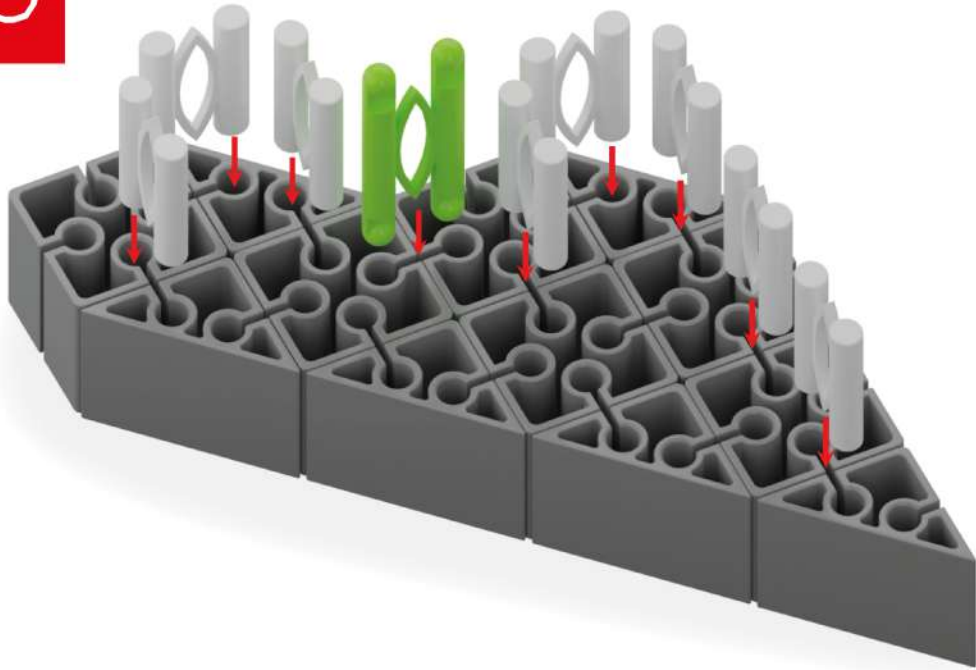

9





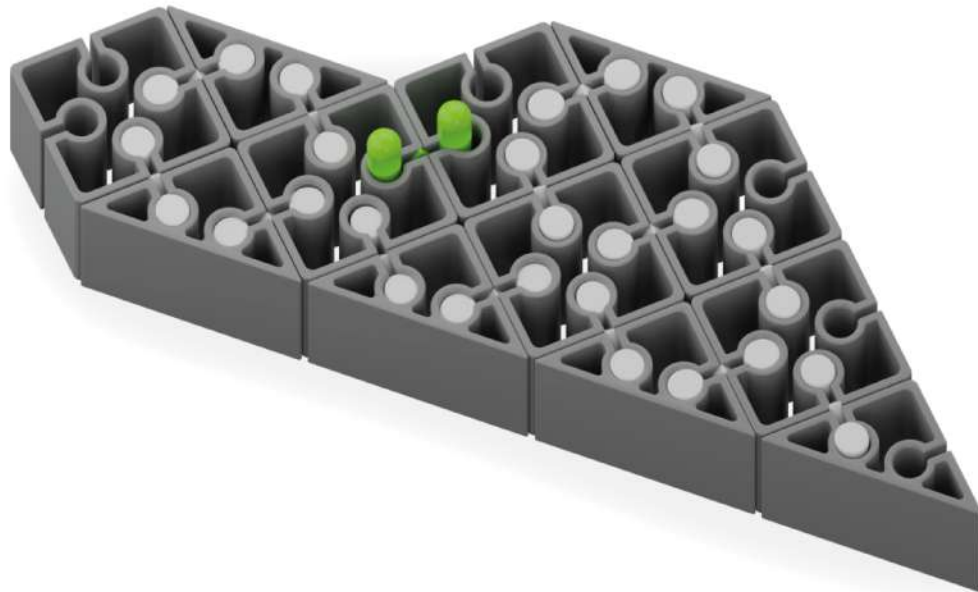
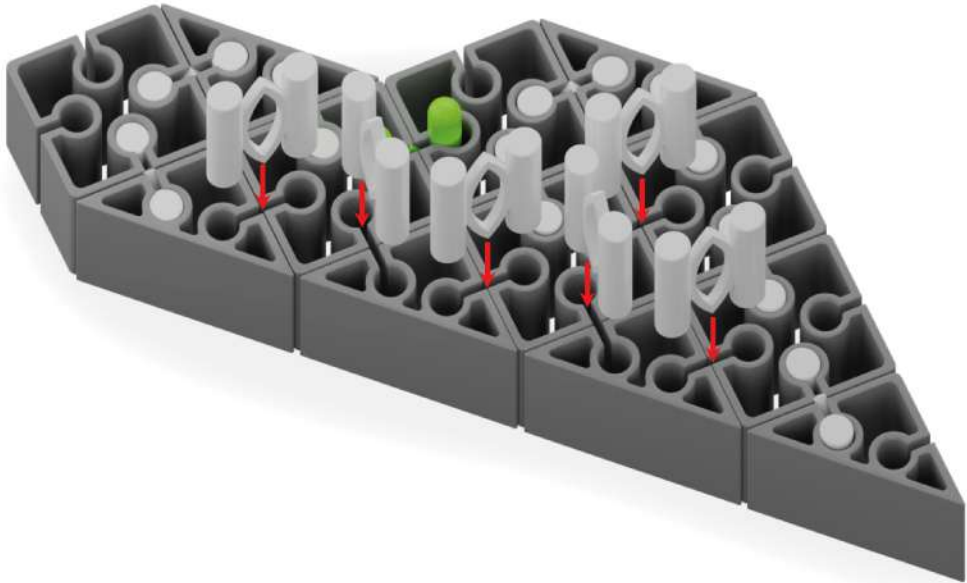

-  x1
-  x14
-  x6
-  x6

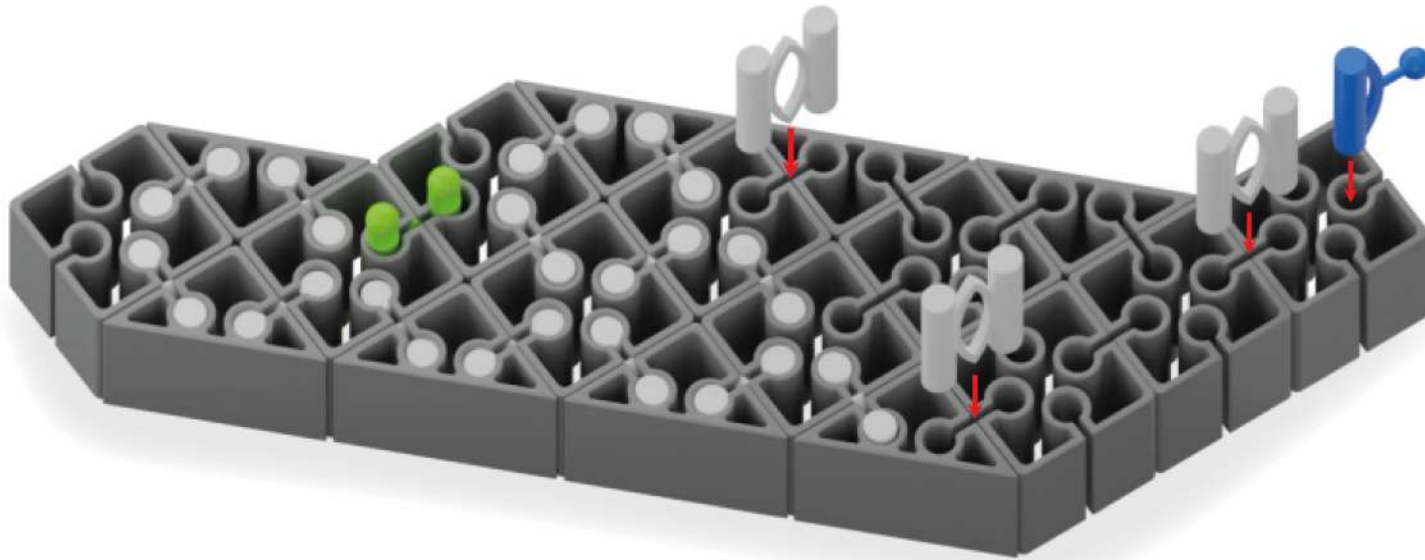

10



 x1	 x3
 x4	 x2



1 1

x2

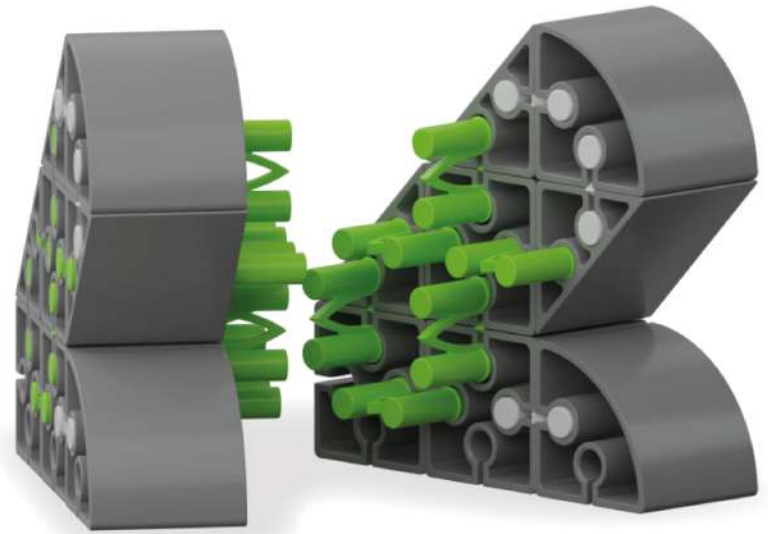
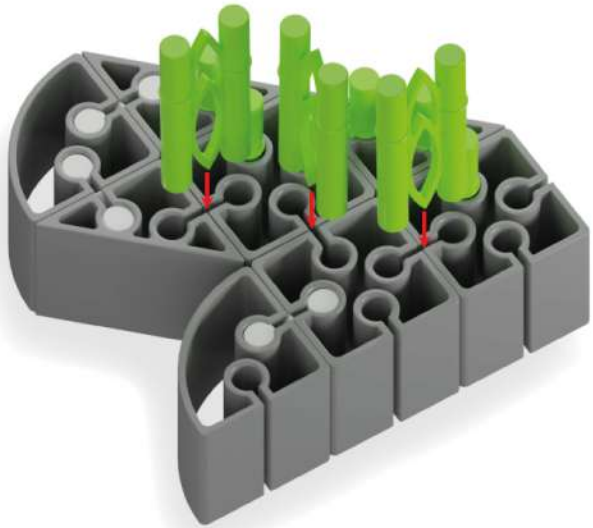
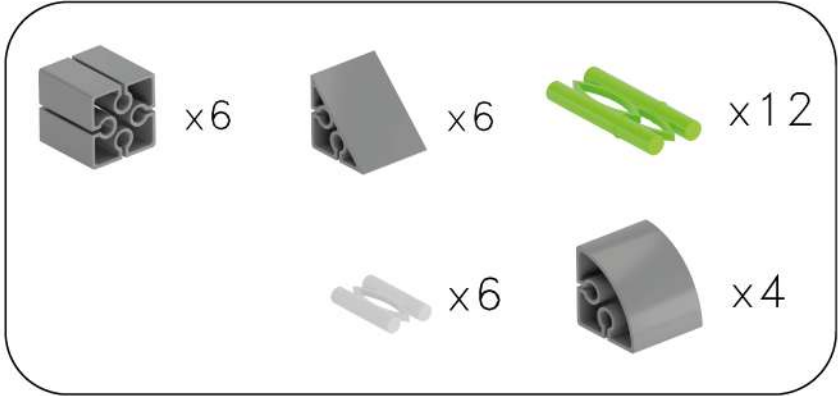
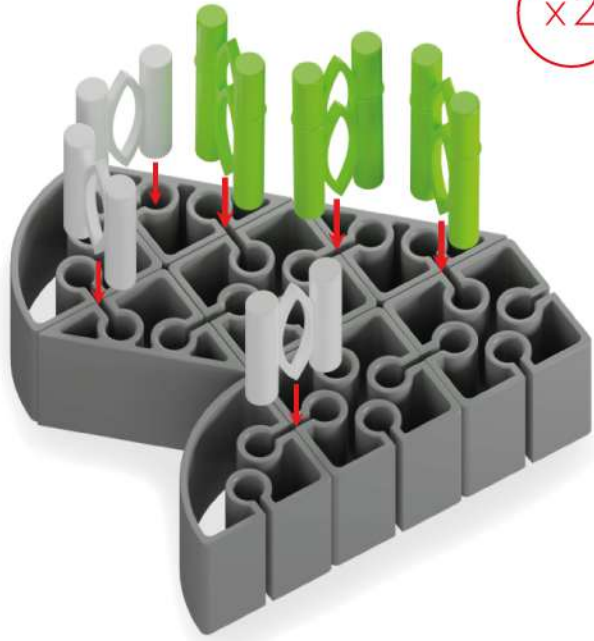



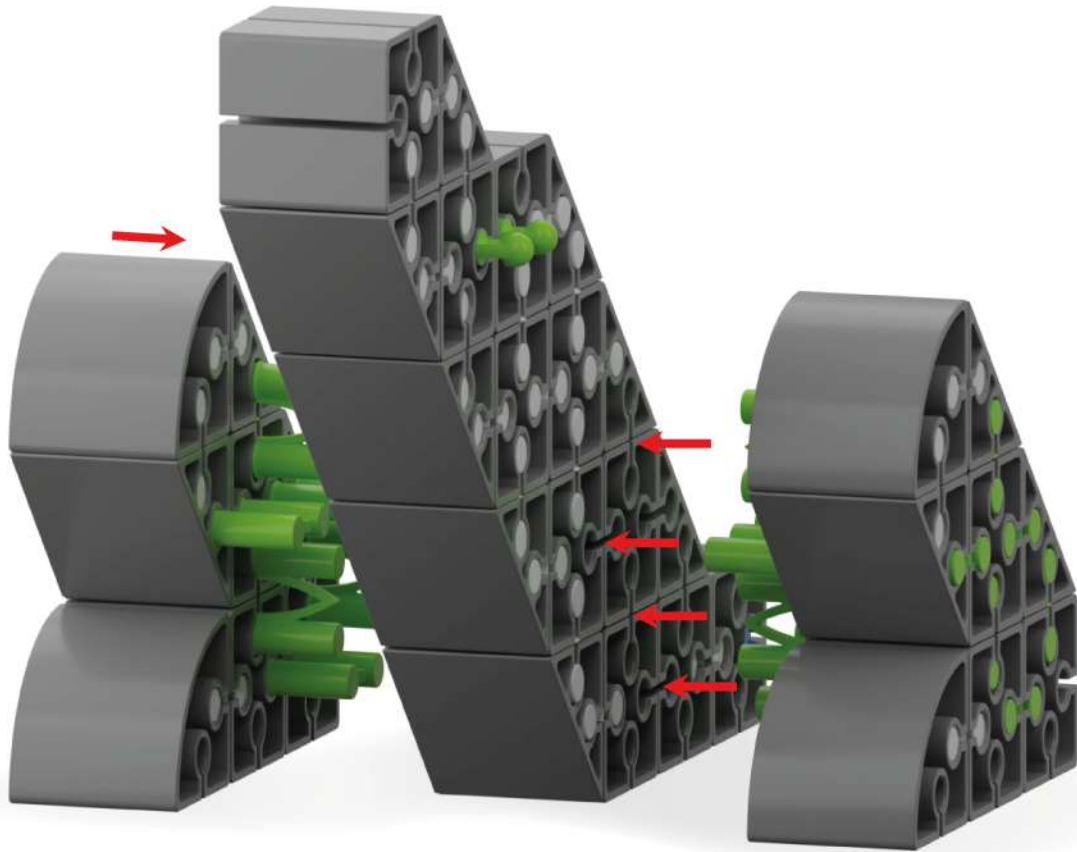

12

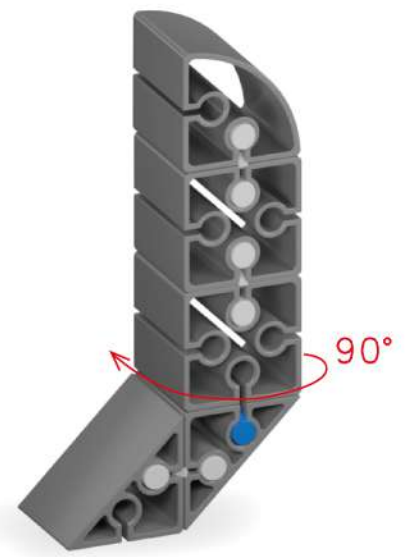
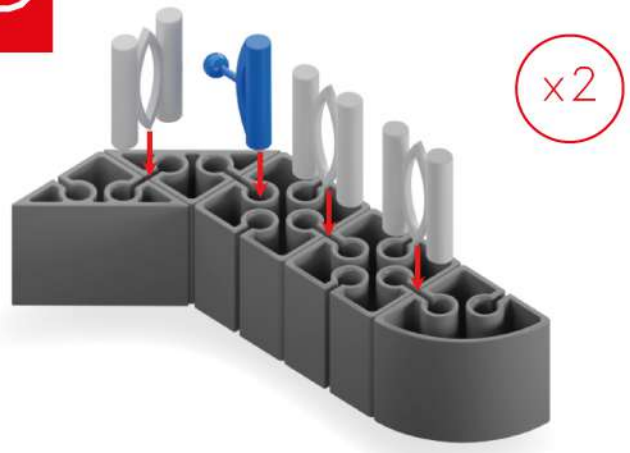

13



-  x4
-  x4
-  x2
-  x6
-  x2

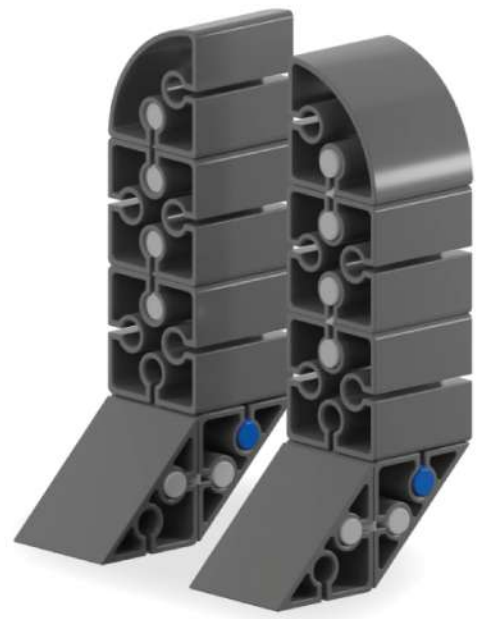
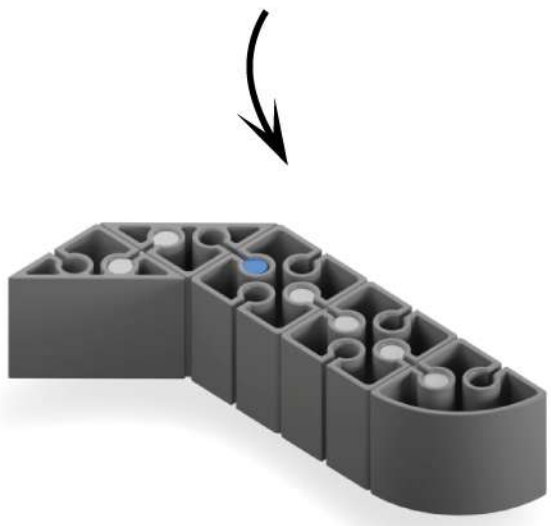

14

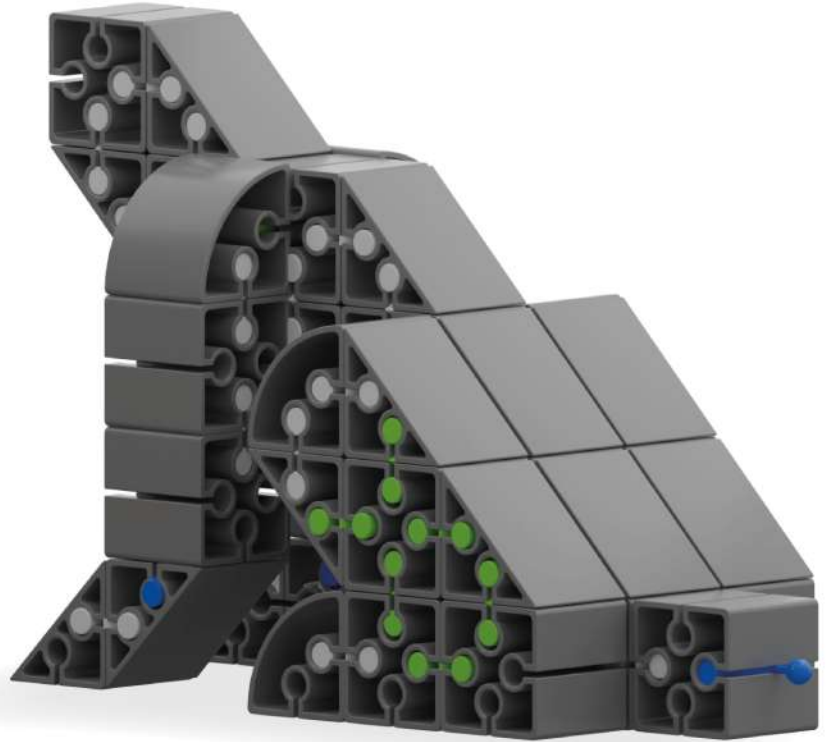

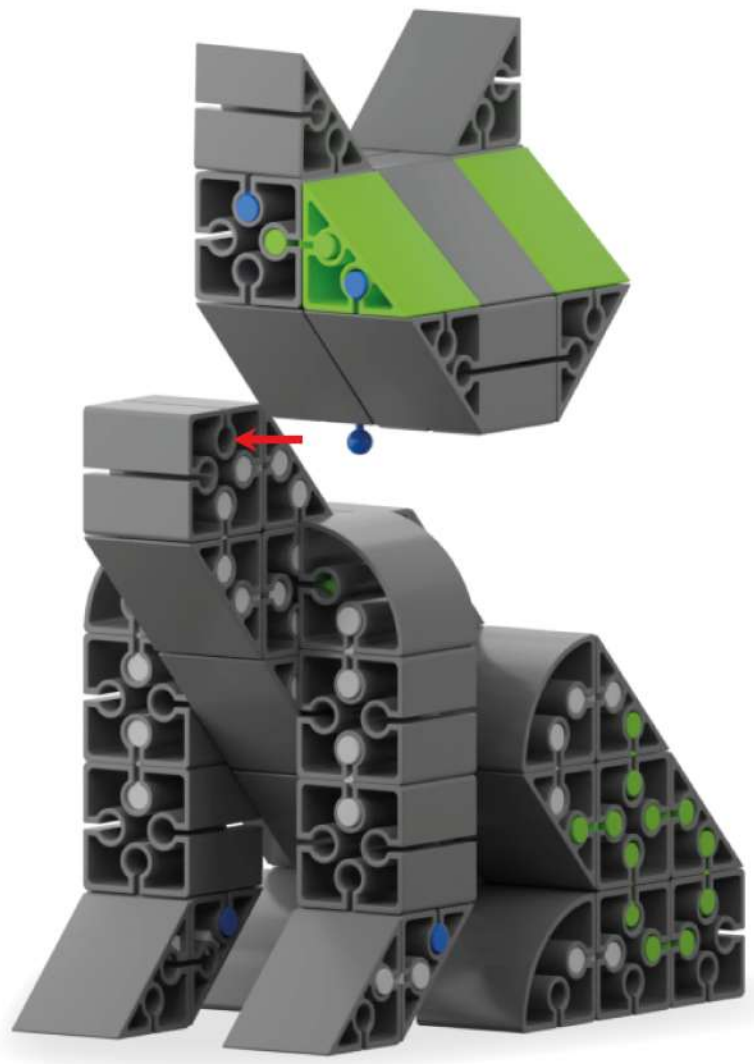



16

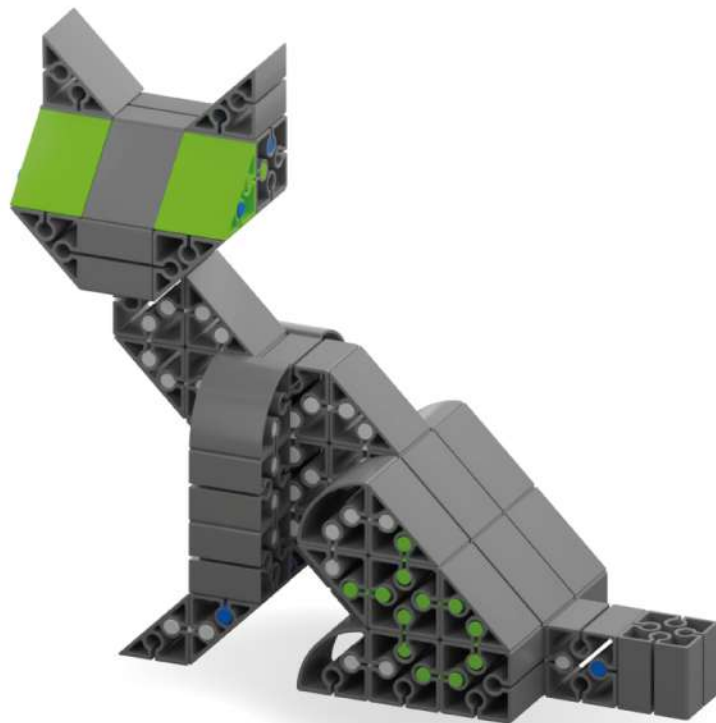
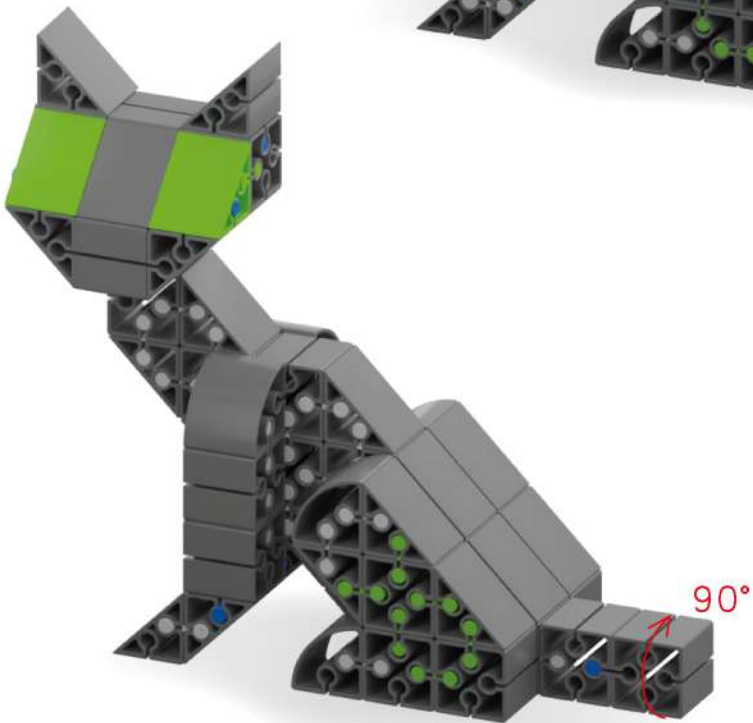
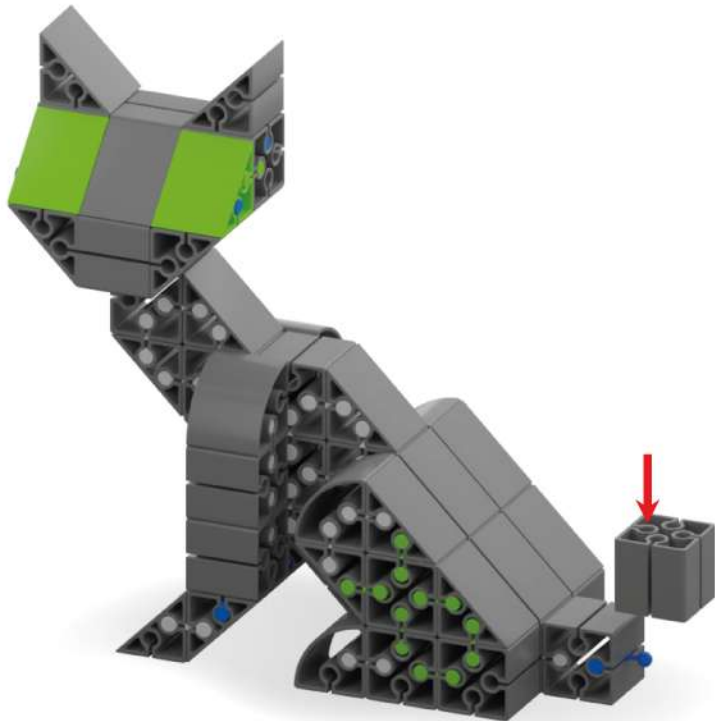
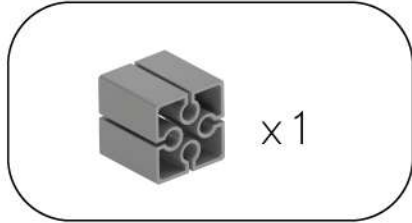

17

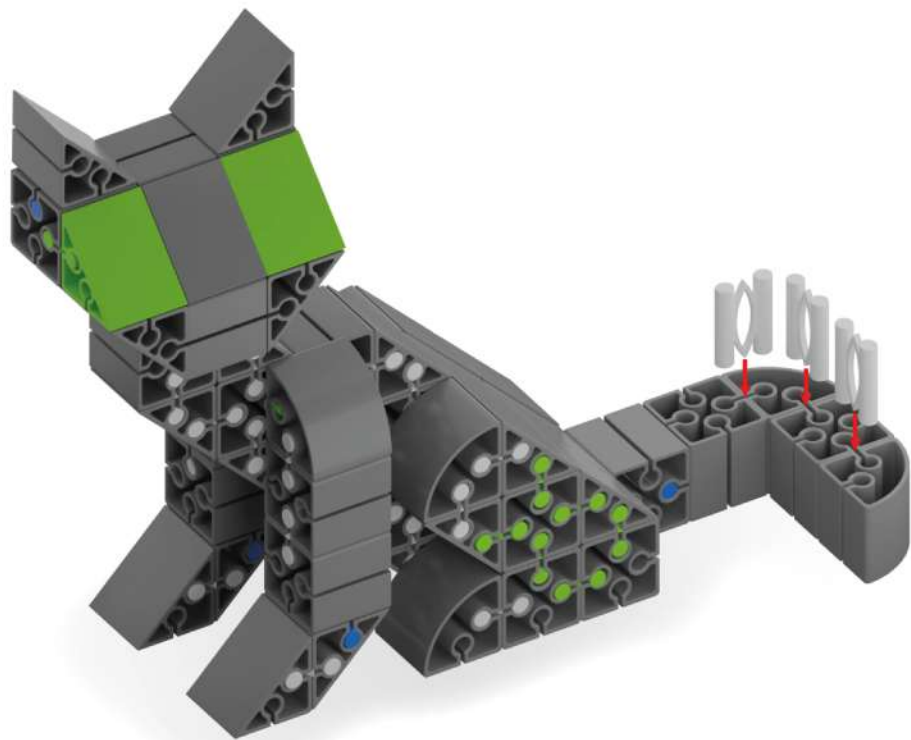

x3

x1

x2

A rounded rectangular box containing a parts list. It shows three grey pins, one grey 1x2 Technic connector, and two grey curved Technic connectors. The quantities are listed as x3, x1, and x2 respectively.

