

ABB Sace

ABB BSD Brushless Servodrives BSD Series

User's Guide



ABB

ABB BSD Brushless Servodrives BSD Series

User's Guide

MANIU23.0606 E

EFFECTIVE: 01.06.2006
SUPERSEDES: None



Safety Instructions

Types and meanings of warnings

In all stages of the installation, operation, maintenance and check of this equipment, reference must be made to this manual and other related documents.

The correct understanding of the equipment, information about safety and other related instructions are essential for this system.

Cautionary indications DANGER and CAUTION are used in this manual to point out particular hazards and to highlight some unusual information which must be specially noted.









Warning	Meaning
 DANGER	If operation is incorrect, a dangerous situation may occur, resulting in death or serious injuries.
 CAUTION	If operation is incorrect, a dangerous situation may occur, resulting in minor to medium injuries or only physical damage to equipment.

An item described under Caution may result in a serious accident, depending on the situation. Both items indicate important procedures, and make sure to observe them.







After reading this manual, keep it in a place where an operator can access it at any time.







Figures

Figures are used so that the meaning of the display may be understood at a glance.



Figure	Meaning	Figure	Meaning
	General notice for inhibition		Action of general operator
	No contact		Make sure to make grounding.
	No disassembly		Be careful of electric shock.
	Be careful of fire.		Be careful of high temperatures.





Precautions for operation

 Danger	
	1. Never touch components inside the servo amplifier as you may receive an electric shock.
	2. Make sure to ground the grounding terminals of the servo amplifier and the servomotor or you may receive an electric shock.
	3. Perform wiring and inspection after waiting 5 minutes after shutting off the power or you may receive an electric shock.
	4. Do not damage cables, subject them to undue stress, put any heavy object on them or pinch them as failure, damage or electric shock may result.
	5. Do not touch the rotating part of the servomotor during operation as you may be injured.



 Caution	
	1. Use the specified combination of the servomotor and the servo amplifier or fire or failure may occur.
	2. Do not use the system in a place where it is exposed to water, a corrosive atmosphere or flammable gas atmosphere, or beside a flammable item as fire or failure may result.
	3. Be careful as the temperature of the servo amplifier, servomotor and peripheral devices is high and may cause burns.
	4. Do not touch the radiator of the servo amplifier, the regenerative resistor and the servomotor during power supply or soon after shutoff because they will be hot and may cause burns.
	5. When the surface temperature of the servomotor exceeds 70 °C for the final product during operation of the servomotor, affix a caution label indicating its high temperature.



Precautions for storage

 Prohibited	
	1. Do not store the system in a place where it is exposed to rain or water drips or where there is a hazardous gas or liquid as failure may result.
	2. Do not store the system directly on the ground if vibration is frequent as failure may result.







 Compulsory	
	1. Store the system in a place where there is no direct sunlight and in the specified range of temperature/humidity (-20 °C to 60 °C, 10% to 90%RH or less, no condensation) or failure may result.
	2. When the system is stored in installed condition Cover the servomotor with a sheet to protect it from humidity, oil or water. Apply rust preventive solution to the machined surfaces (shaft and flange surfaces) every 6 months. To prevent bearings rusting, perform manual turning or 5 minute idling once a month.
	3. If storage is to be for a long time, contact us.





Precautions for transportation

 Caution	
	• Do not hold the cable or the motor shaft during transportation as failure or injuries may result.



 Compulsory	
	1. Overloading of products may result in the collapse of piles. Observe the instructions.
	2. Use the servomotor eyebolt only for transportation of the servomotor not for transportation of the machine as failure or injuries may result.





Precautions for installation



 Caution	
	1. Do not ride on the servomotor or put a heavy object on the servomotor as failure, damage, electric shock or injuries may result.
	2. Close the exhaust opening to prevent entry of foreign matter or fire or electric shock may result.
	3. Make sure to observe the installation directions or fire or failure may result.
	4. Maintain the specified distance between the main unit and the control panel or other devices or failure may result.
	5. Do not subject to strong impact or failure may result.

 Compulsory	
	1. The servomotor shaft thru-hole is not waterproofed or oil-proofed. Take necessary precautions for the machine to prevent entry of cutting oil into the servomotor or failure may result.
	2. If the system is used in an environment where the servomotor is exposed to many water drips or oil drips, take precautions including a drip cover over the machine. The servomotor itself can be subjected to a few splashes without serious consequences. In an environment where there is much humidity or oil mist, perform wiring so that lead wires and connectors face downward or failure may result due to poor insulation or short-circuit.
	3. Never modify the servomotor as a fire or failure may result.







Precautions for wiring



 Caution	
	<ul style="list-style-type: none">• Perform wiring correctly or a fire, failure, burns or injuries may result.



 Prohibited	
	1. Never connect the commercial power supply (200V) to the U, V and W terminals of the servomotor or a fire or failure may result.
	2. Do not connect a grounding wire (E) to the U, V and W terminals of the servomotor and do not connect U, V and W terminals in the wrong order or a fire or failure may result.
	3. Never perform the withstanding voltage, megger and buzzer tests at the encoder terminal as the encoder may be damaged. To perform the withstanding voltage, megger and buzzer tests at the U, V and W terminals of the servomotor, separate the connections from the servo amplifier before the test.
	4. Do not connect the encoder terminals in the wrong order as the encoder and the servo amplifier may be damaged.

 Compulsory	
	<ul style="list-style-type: none">• Grounding is performed to prevent electric shock in an emergency. Make sure to perform grounding for safety.



Precautions for operation

 Caution	
	1. Extreme adjustment or changes may result in unstable operation and injuries may result.
	2. During test operation, fix the servomotor and check operation of the servomotor with it separated from the machine before installing it in the machine or injuries may result.
	3. The retention brake is not the stop system but for safety of the machine. Provide a stop system to ensure safety on the machine or failure or injuries may result.
	4. If an alarm occurs, remove the cause and confirm safety. Reset the alarm and restart operation or injuries may result.
	5. After instantaneous stop and recovery, the system may suddenly restart; do not approach the machine (design the machine so that human safety is ensured even after restart) or injuries may result.
	6. Make sure that the power supply specification is correct or a fire, failure or injuries may result.

 Prohibited	
	• The brake incorporated in the servomotor is for retention. Do not use it for normal braking or failure or injuries may result.

 Compulsory	
	• Provide external emergency stop circuits so that the operation may be stopped immediately and that the power may be shut off or fire, failure, burns or injuries may result.

Precautions for maintenance and inspection

 Prohibited	
	• Do not disassemble the system for repairs other than an expert engineer. If it is necessary to disassemble the motor, contact the shop you purchased or nearest sales office.

Descriptions given in this manual may be different from those of the product as a result of improvements of the product. Descriptions in this manual are subject to change without notice.

Values are indicated in SI units (third stage) in this manual. The units may be different from those indicated on the product (nameplate).

Illustration given in this manual may show the servo amplifier or servomotor of a specific capacity. Accordingly they may be different from the appearance of the product you have purchased.

Products introduced in this manual have not been designed or manufactured for such applications in a system or equipment that will affect human bodies or lives. Customers, who want to use the products introduced in this manual for special systems or devices such as for atomic-energy control, aerospace use, medical use, and traffic control, are requested to consult ABB Sace.

Customers are requested to prepare safety measures when they apply the products introduced in this manual to such systems or facilities that will affect human lives or cause severe damage to property if the products become faulty.

Introduction

This manual is the User's Manual for ABB Sace's BSD Series AC Servo System. The User's Manual comes in one volume and covers all handling procedures of the product.

The following document is included in the package of each device

Device	Name of document	Document N°
Servo amplifier	BSM Servo Short Instruction manual	MANIU23.0606
Servomotor	BSM Motor Short Instruction manual	MANUM23.0604

The type designation of the product covered in this manual is shown below.

Device	Product code	Capacity [W]
Servo amplifier	BSD0100	100
	BSD0200	200
	BSD0400	400
	BSD0750	750
	BSD1000	1000
	BSD1500	1500
	BSD2000	2000
Servomotor	BSM0100CN00	100
	BSM0100CB00	100
	BSM0200CN00	200
	BSM0200CB00	200
	BSM0400CN00	400
	BSM0400CB00	400
	BSM0750CN00	750
	BSM0750CB00	750
	BSM1000CN01	1000
	BSM1000CB01	1000
	BSM1500CN01	1500
	BSM1500CB01	1500
	BSM2000CN01	2000
	BSM2000CB01	2000

Icons

In this manual, the following icons are used:



If the system is incorrectly operated by ignoring this mark, the optimum performance of BSD may not be shown, or such an operation or setting may result in an accident.



Useful reference items are given for operation or setting of the servo amplifier or the servomotor.



The page for reference is shown.

Table of Contents

Safety Instructions	3
Types and meanings of warnings.....	3
Figures	3
Precautions for operation	4
Precautions for storage	5
Precautions for transportation	5
Precautions for installation	6
Precautions for wiring	7
Precautions for operation	8
Precautions for maintenance and inspection.....	8
Introduction	10
Introduction.....	10
Icons	10
Table of Contents	i
Chapter 1 - Outline	1-1
Items to be confirmed.....	1-1
Servomotor	1-2
Servoamplifier	1-3
Explanation of Model Codes.....	1-4
Servoamplifier	1-4
Servomotor	1-4
Chapter 2 - Installation	2-1
Servomotor	2-1
Storage temperature	2-1
Operating environment.....	2-1
Mounting	2-1
Handling.....	2-2
Power supply to servomotor	2-2
Cable stress	2-3
Protection against water and oil.....	2-3
Dimensional tolerances.....	2-4
Load	2-4
Servoamplifier	2-6
Storage environment	2-6
Operating environment.....	2-6
Mounting	2-7
Handling.....	2-8
Power supply to servo amplifier	2-9
Depth of amplifier.....	2-9
Chapter 3 - Wiring	3-1
Configuration	3-1

Table of Contents

Servo Amplifier	3-3
Frame 1	3-3
Commercial power supply	3-4
Servo amplifier of 0.4kW or less.....	3-4
Servo amplifier of 0.75kW	3-4
Servo amplifier of 0.85kW or larger	3-5
Control power supply (common to all models)	3-5
Power supply capacity	3-7
Action to prevent harmonic wave.....	3-7
Motor power input/control power input.....	3-8
Servo amplifier of “connector type”	3-8
Connector for motor power	3-8
Connector for control power.....	3-9
Servo Amplifier of “Terminal block type”	3-9
Sequence input/output (CN1)	3-10
Interface circuit diagram.....	3-11
Wiring example of pulse string input	3-12
Encoder (CN2).....	3-13
Loader (CN3).....	3-14
Terminal functions and interface.....	3-14
Monitor pin (CN4)	3-15
Servomotor	3-16
BSM type 3000 RPM series	3-16
BSM type 2000 and 1500 RPM series.....	3-16
Servomotor.....	3-17
BSM type 3000 RPM series	3-18
BSM type 2000 RPM series	3-18
Brake.....	3-19
Encoder	3-20
BSM models 3000 RPM	3-20
BSM models 2000 RPM	3-20
Wiring cable.....	3-21
Cable size	3-21
Preparation method of encoder cable.....	3-22
<Example>.....	3-23
Connection diagrams.....	3-24
Chapter 4 – Test Operation.....	4-1
Check items for power supply	4-1
Check items before power supply for the first time	4-1
Check items when power is supplied for the first time.....	4-1
Test operation in three stages	4-2
First stage	4-2
Second stage	4-2
Third stage	4-2
First stage.....	4-3
Test operation procedure	4-3
Second stage	4-5
Common for all control (position/speed/torque) modes	4-5
Test operation procedures.....	4-5
Position control mode	4-6
Test operation procedures.....	4-6
Troubleshooting	4-8
Speed/torque control mode.....	4-9
Test operation procedures.....	4-9
Troubleshooting	4-11

Table of Contents

Third Stage 4-12
 Test operation procedure..... 4-12
 Brake timing output..... 4-13
 Notes 4-13
 Timing chart..... 4-13
 Return to origin 4-14

Chapter 5 – Parameters 5-1

Parameter configuration 5-1
 Parameter editing method..... 5-1
 Parameter editing through keypad operation 5-1
 Parameter editing through BSD Configurator..... 5-2
 List of parameters..... 5-3
 Explanation of parameter..... 5-8
 Parameter #01 and #02..... 5-8
 Calculation formula for command pulse correction α and β 5-8
 Setting from BSD Configurator 5-8
 Parameter #03 5-10
 Command pulse/command sign (Setting of parameter 03: 0)..... 5-10
 Forward / reverse rotation pulse (Setting of parameter 03: 1) 5-11
 Two signals with 90-degree phase difference (Setting of parameter 03: 2)5-11
 Parameter #04 5-12
 Forward/reverse rotation 5-12
 Parameter #05 5-13
 Auto tuning (Setting of basic setting parameter 05: 0) 5-13
 Semi-auto tuning (Setting of parameter 05: 1)..... 5-13
 Manual tuning (Setting of parameter 05: 2)..... 5-13
 Parameter #06 5-14
 How to specify the load inertia ratio..... 5-15
 Parameter #07 5-16
 Setting method 5-16
 Approximate measure for setting 5-16
 Parameter #08 5-17
 Parameter #09 5-18
 Switching method to each control mode 5-18
 Transition time to each control mode 5-19
 Position control 5-19
 Speed control..... 5-19
 Torque control..... 5-19
 Parameter #10-#14 5-20
 Parameter #15 - #18 5-20
 (1) Servo on [RUN]..... 5-22
 Function 5-22
 Parameter setting 5-22
 Reference 5-22
 (2) Reset [RST]..... 5-23
 Function 5-23
 Parameter setting 5-23
 Reference 5-23
 (3) Overtravel and overtravel detection..... 5-24
 Function 5-24
 Parameter setting 5-24
 Reference 5-24
 (4) Forced stop and forced stop detection..... 5-26
 Function 5-26
 Parameter setting 5-26

Table of Contents

Reference	5-26
(5) P-action	5-27
Function	5-27
Parameter setting	5-27
(6) Deviation clearance.....	5-28
Function	5-28
Parameter setting	5-28
Reference	5-28
(7) Regenerative resistor overheat.....	5-29
Function	5-29
Parameter setting	5-29
Reference	5-29
(8) Anti-resonance frequency selection 0/1	5-30
Function	5-30
Parameter setting	5-30
Reference	5-30
(9) Command pulse inhibition	5-31
Function	5-31
Parameter setting	5-31
For pulse string operation and manual operation.....	5-31
When only pulse string operation is performed	5-32
(10) Command pulse compensation α selection 0/1	5-33
Function	5-33
Command pulse compensation	5-33
Parameter setting	5-33
Reference	5-33
(11) Control mode switching.....	5-34
Function	5-34
Control mode (parameter #09)	5-34
Parameter setting	5-34
Reference	5-34
(12) Forward rotation command [FWD]/Reverse rotation command [REV].....	5-35
Function	5-35
Parameter setting	5-35
Reference	5-36
(13) Multistep speed 1 [X1]/2 [X2].....	5-37
Function	5-37
Parameter setting	5-37
(14) Acceleration/deceleration time selection.....	5-38
Function	5-38
Parameter setting	5-38
(15) Current limit valid/current limit detection	5-39
Function	5-39
Parameter setting	5-39
Reference	5-39
(16) Coasting [BX]	5-40
Function	5-40
Parameter setting	5-40
Reference	5-40
(17) Ready [RDY].....	5-41
Function	5-41
Parameter setting	5-41
(18) Positioning end [PSET]	5-42
Function	5-42
Parameter setting	5-43
Reference	5-43
(19) Alarm detection: a-contact (b-contact).....	5-45

Table of Contents

Function	5-45
Parameter setting	5-45
(20) Dynamic brake	5-46
Function	5-46
Parameter setting	5-46
Reference	5-46
(21) Zero deviation	5-47
Function	5-47
Parameter setting	5-47
(22) Zero speed	5-48
Function	5-48
Parameter setting	5-48
(23) Brake timing	5-49
Function	5-49
Parameter setting	5-49
Reference	5-49
Connection example of brake timing signal (0.4 [kW] or less)	5-51
Parameter #19	5-52
Parameter #20	5-53
Output position of phase-Z signal	5-53
Reference	5-53
Parameter #21	5-54
Parameter #22	5-55
Parameter #23	5-55
Parameter #24	5-56
Parameter #25	5-56
Parameter #26	5-56
Parameter #27	5-57
Parameter #28	5-57
Parameter #29	5-57
Parameter #30	5-58
Parameter #31-#33	5-59
Parameter #34	5-59
Parameter #35 - #38	5-60
Parameter #39	5-61
Control system settings	5-62
Parameter #40 - #42	5-64
Parameter #45 - #46	5-64
Position controller gain 1 (Parameter 40)	5-65
Speed response 1 (Parameter 41)	5-65
Speed controller integration time 1 (Parameter 42)	5-65
Feed forward filter time constant (Parameter 45)	5-65
Torque filter time constant (Parameter 46)	5-65
Parameter #43	5-65
Parameter #44	5-66
Parameter #47	5-66
Parameter #48 - #53	5-67
Parameter #54	5-68
Parameter #55	5-68
Parameter #56 - #59	5-69
Notch filter setting method	5-69
Parameter #60 - #63	5-70
Parameter #64 - #69	5-70
Parameter #70 - #71	5-71
Analog command gain	5-71
Analog command offset	5-72
Resolution during speed control (speed command voltage)	5-73

Table of Contents

Resolution during torque control (torque command voltage) 5-73
Parameter #72 5-73
Parameter #73 5-73
Parameter #74 - #77 5-74
Parameter #78 - #80 5-75
Parameter #81 5-75
Parameter #82 - #83 5-76
Parameter #84 - #86 5-76
Parameter #87 - #92 5-77
 Monitor 1/monitor 2 signal allocation 5-77
 Monitor 1/monitor 2 scale 5-77
 Monitor 1/monitor 2 offset 5-78
 Monitor 1 output type (speed feedback) 5-78
 Resolution of monitor 1/monitor 2 output 5-78
Parameter #93 5-78
Parameter #94 - #97 5-79
Parameter #98 - #99 5-79

Chapter 6 – Adjustment of Servo 6-1

Adjustment procedures 6-1
Smart Tuning 6-1
 What is "Smart Tuning" 6-1
 Operation pattern of Smart Tuning 6-2
 Cautions for Smart Tuning 6-2
 Description of operation 6-3
 (1) Slow run 6-3
 (2) Smart Tuning 6-4
 Factor of NG display 6-6
Pattern operation 6-6
 What is pattern operation? 6-6
 Tip 6-6
 Description of operation 6-7
Basic adjustment 6-8
 Parameters automatically adjusted in the auto or semi-auto tuning mode 6-9
 Approximate measure for auto tuning gain (parameter #7) setting 6-10
Application adjustment 6-11
 1. Check the mechanical system 6-11
 2. Adjust the large inertia 6-11
 How to check if the load inertia ratio exceeds 100 times (or 30 times)* 6-12
 How to set the notch filter (parameters #56 through #59) 6-13
Adjustment requiring high speed response 6-14
Overshoot adjustment (only for position control) 6-15
Adjustment for shortening stabilization time (only for position control) 6-16
 In the case of under-run: 6-16
 In the case of over-run: 6-16
Standard values for adjustment parameters 6-17

Chapter 7 – Special Adjustments 7-1

Vibration suppressing control 7-1
 What is vibration suppressing control? 7-1
 (1) Purpose of vibration suppressing control 7-1
 (2) Principle of vibration suppressing control 7-2
 (3) Machine characteristics and conditions valid for vibration suppressing control
 7-2
 Parameter setting method 7-3
 ① Adjust the gain of the servo 7-3

Table of Contents

② Check the anti-resonance frequency.	7-4
③ Setting parameters #60 through #63.....	7-6
④ Specify parameter #43 (S-curve time constant)	7-7
⑤ Check the effect.....	7-7
⑥ Finely adjust parameters #60 through #63	7-7
Command following control	7-8
What is command following control?.....	7-8
Mechanical system realizing command following control	7-8
Parameter setting method	7-9
Chapter 8 – Keypad	8-1
Display	8-1
Mode	8-1
Operation key	8-2
Mode select.....	8-2
Function list.....	8-3
Sequence monitor mode	8-5
Monitor mode	8-9
Parameter editing mode	8-15
Test running mode	8-19
Chapter 9 – Inspection and maintenance.....	9-1
Inspection.....	9-1
Memory back-up	9-2
Alarm indication.....	9-3
Items to specify when faulty.....	9-17
Expected service life and discharge.....	9-18
Part replacement	9-19
Chapter 10 – Characteristics	10-1
Timing chart.....	10-1
Overload characteristics	10-6
BSM (0.1-0.75 KW) motor	10-6
BSM (1.0-2.0 KW) motor	10-7
Power supply capacity and generation loss	10-8
Inrush current	10-8
Chapter 11 – Specifications	11-1
List of servomotor specifications	11-1
Low inertia series (BSM 0.1-0.75 KW motor) 3000r/min	11-1
Middle inertia series (BSM 1.0-2.0 KW motor) 2000r/min	11-2
Servo amplifier basic specification	11-3
BSM (0.1-0.75 KW) motor (3000r/min) compatible servo amplifier	11-3
BSM (1.0-2.0 KW) motor (2000r/min) compatible servo amplifier	11-4
Speed-torque characteristics	11-5
Low inertia series (BSM (0.1-0.75 KW) motor) 3000r/min.....	11-5
Middle inertia series (BSM (1.0-2.0 KW) motor) 2000r/min.....	11-6
External Dimension.....	11-7
Low inertia series (BSM 0.1-0.75 KW motor) 3000r/min	11-7
Middle inertia series (BSM 1.0-2.0 KW) motor 2000r/min	11-7
Servo amplifier	11-8
Chapter 12 – RS485 Communications.....	12-1

Table of Contents

- RS485 communication function 12-1
 - Station number 12-1
 - Sequence input terminal (CONT1 to CONT5)/sequence output terminal (OUT1 to OUT4) 12-1
 - Response time 12-1
 - Communication specifications 12-2
 - Transmission protocol 12-3
 - Description of transmission data 12-4
 - Status information 12-5
 - List of commands 12-6
- Command transmission specification 12-7
 - Communication start procedure 12-7
 - Normal communication procedure 12-7
- Protocol level error 12-8
 - Multiple monitor data read 12-8
 - Sequence mode read 12-9
 - Sequence input/output signal read 12-10
 - Alarm history read 12-10
 - System status read 12-11
 - Current alarm history read 12-11
 - Parameter read 12-12
 - Parameter write 12-13
 - Alarm reset 12-13

Chapter 1 - Outline

Items to be confirmed

When the product (BSD Series) is delivered to you, unpack and check the following.

Items to be confirmed	Checking method	Check mark
Is the delivered BSD Series what you have ordered?	Check the "type" field in the motor and amplifier nameplates shown in the following pages.	
Is there any damage around the product?	Observe the appearance to check for broken parts.	
Check if the servomotor shaft rotates smoothly.	Turn by hand. If the shaft rotates smoothly, there is no problem. However, the shaft does not turn with servomotors equipped with a brake.	
Are any screws dislocated or loose?	Perform visual check.	

If any defects are found, contact your dealer or ABB Sace sales department (shown on the back cover of this manual) immediately

Servomotor

Appearance of product (Example: BSM0200CN00)

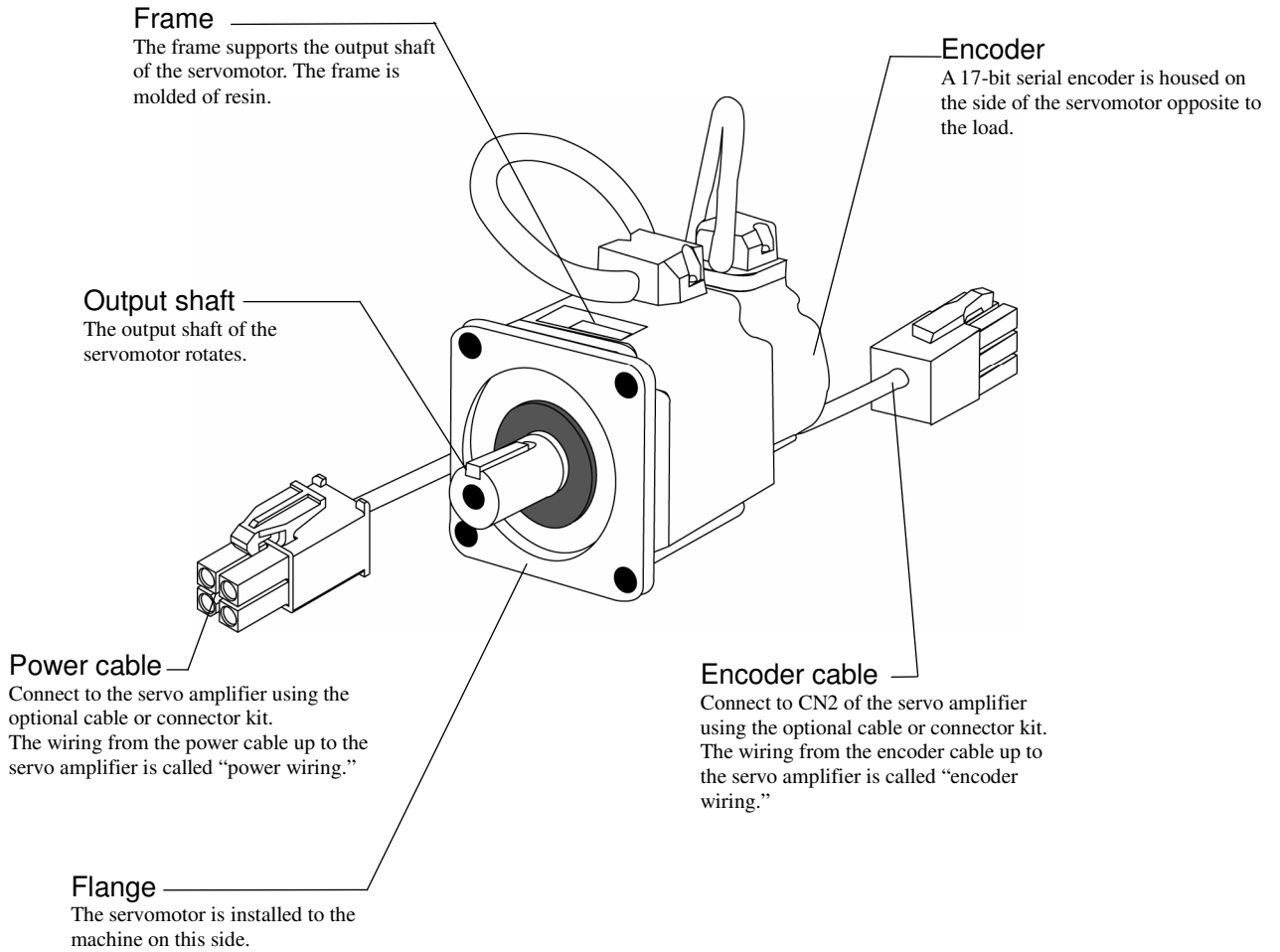

How the nameplate looks

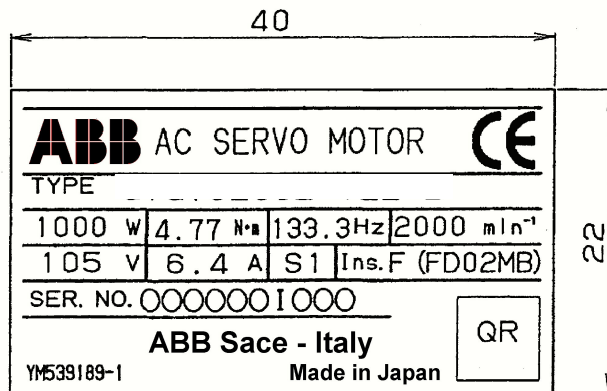

Servoamplifier

Appearance of product (Example: BSD0400)

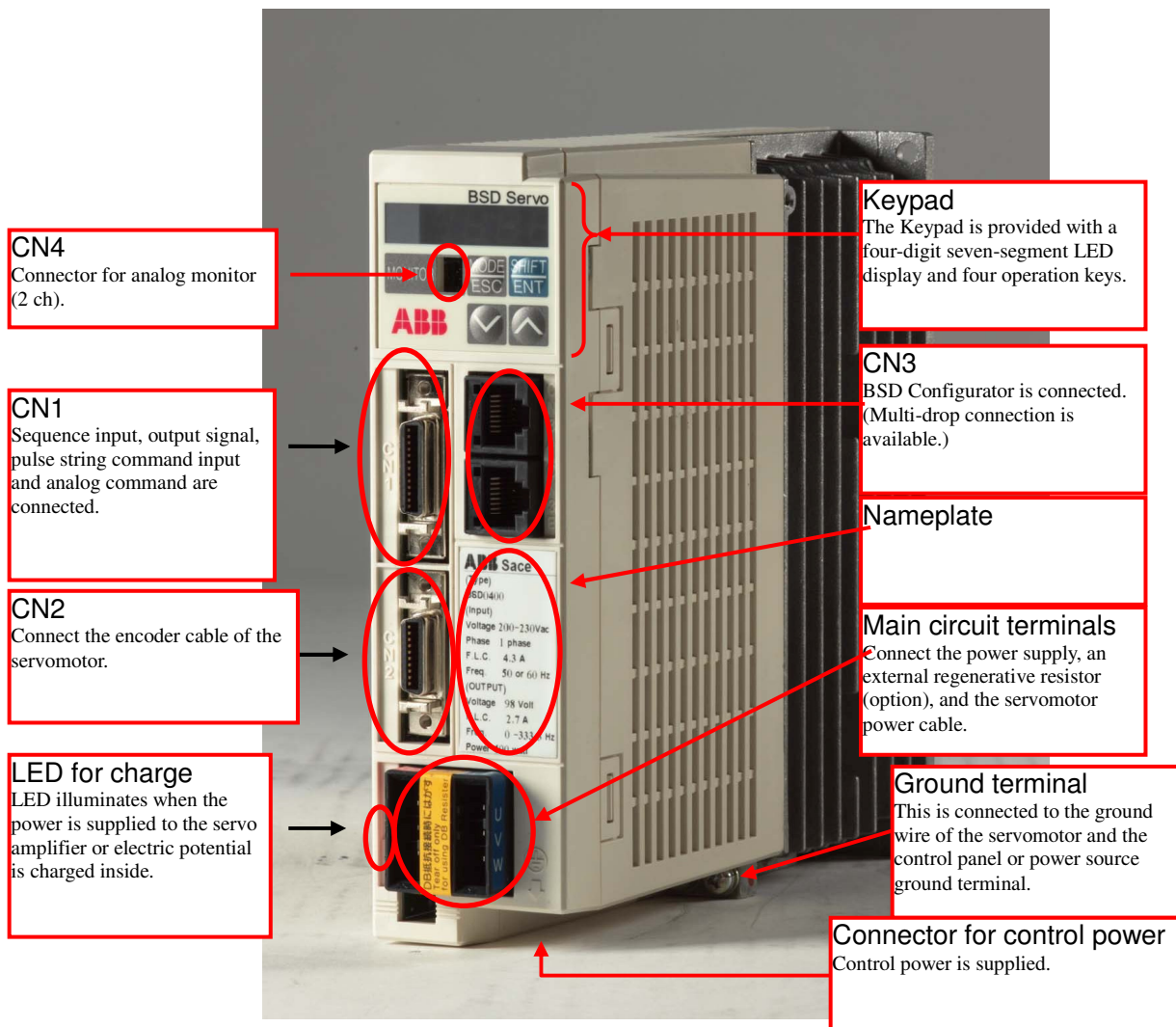

How the nameplate looks

ABB	
Amplifier type	[TYPE] RYC201D3-VVT2
Input voltage	[INPUT] Voltage 200-230V
No. of input phases	Phase 3Φ
Maximum input current	F.L.C 6.4A
Input frequency	Freq. 50 or 60Hz
Output voltage	[OUTPUT] Voltage 104V
No. of output phases	Phase 3Φ
Maximum output current	F.L.C 7.1A
Output frequency	Freq. 0-333.3Hz
Output capacity	Power 1000W
Serial number	[SER.No.] 359003A001325A
ABB Sace - Italy Made in Japan	

Explanation of Model Codes

Servoamplifier This servoamplifier has few options. Only the power can be specified, as follows

Family	Power [W]
BDM	XXXX

Servomotor This servomotor has few options. The power, shaft type, brake can be specified. At the moment no further options are available.

Family	Power [W]	Shaft	Brake	Options
BSM	XXXX	C (keyway)	N (no brake)	00 (No options)
BSM	XXXX	L (flat)	B (with brake)	01 (Oil seal)

Chapter 2 - Installation

Servomotor

Storage temperature Store the servomotor in the following environment when leaving it without energization.

Storage temperature : -20 to 60 °C

Storage humidity : 10 to 90% RH (no condensation allowed)

* To store the gear head without power supplied, store it in the following environment:

Storage temperature : -20 to 60 °C

Storage humidity : 10 to 90% RH (no condensation allowed)

Operating environment Operate the servomotor in the following environment.

Operating temperature : -10 to 40 °C

Operating humidity : 10 to 90% RH (no condensation allowed)

*Use the gear head in the following operating environment.

Operating temperature : 0 to 40 °C

Operating humidity : 10 to 90% RH (no condensation allowed)

Mounting The servomotor can be mounted horizontally, downward or upward. The same rule applies to the servomotor equipped with a brake

The symbol in the figure indicates the mounting method coded by IEC. Description in parentheses () indicates the former JEM code.

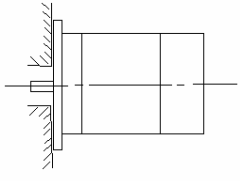
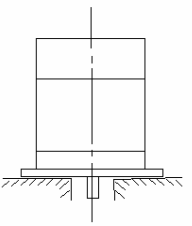
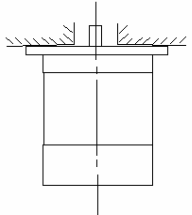

Flange-mounted		
IM B5 (L51)	IM V1 (L52)	IM V3 (L53)
		

Handling The servomotor is equipped with a built-in encoder. Do not hammer the output shaft of the servomotor because the encoder is a precision device.

Do not support the encoder to lift the servomotor during installation.

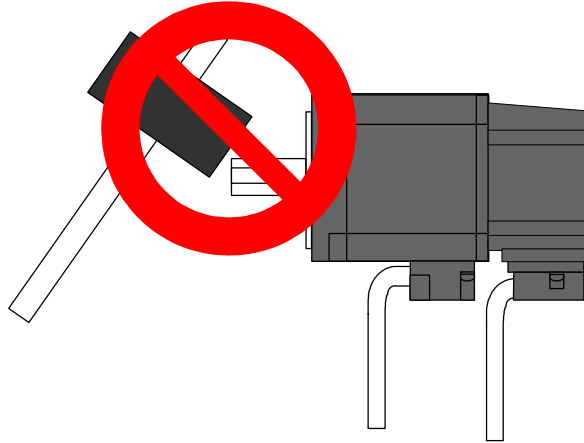
The encoder built in the servomotor has been aligned with the servomotor. If it is disassembled, the rated performance will not be obtained.



 CAUTION	
	<ul style="list-style-type: none">■ Never give shocks to the servomotor by hitting with a hammer etc. Otherwise the encoder will be broken, causing the servomotor to run away.■ Do not disassemble the servomotor. If the servomotor is disassembled, the performance will deteriorate and the mechanical system may be broken.

Power supply to servomotor Do not supply commercial power directly to the servomotor as the servomotor may be burned.

The servomotor cannot be used without connection to the corresponding amplifier.

For the connection method between the servomotor and servo amplifier, see chapter 3.

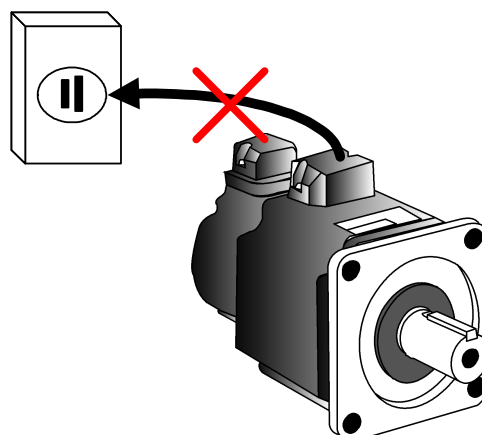

Cable stress Do not apply bending or tensile stress to the cable.

Precautions for applications with moving servomotor

- Design a system of an application with a moving servomotor so that the cables are free from forcible stress.
- Route the encoder cable and power cable in Cableveyor.
- Fix the encoder cable and power cable from the servomotor using cable clamps.
- Design the bending radius as large as possible.
- Do not allow bending stress or the weight of the cable itself to be exerted at cable connections.

Protection against water and oil

- Measures taken to the motor are useful for protection against moderate amount of splashes.

However, the shaft is not water-proof or oil resistant, and so take appropriate measures on the machine side to avoid entry of water and oil into the servomotor.

- In environments with significant water droplets, oil film or oil mist, provide covers over the machines.
- When the servomotor is installed horizontally, route the power cable and the encoder cable downwards. Provide a cable trap when the servomotor is installed vertically or inclined.

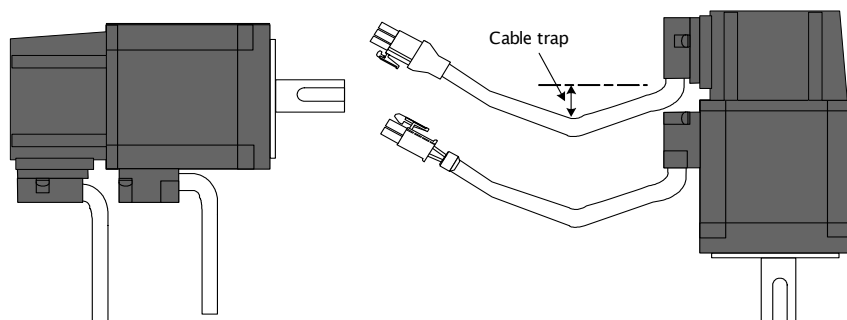

- Do not use the servomotor while the cable is immersed in oil/water sump
- If the motor is exposed to splashes of oil such as cutting oil, some oil may adversely affect seal material, packing and cable.
- The servomotor with an oil seal may produce a squeaking sound from the oil seal during operation, but this is not a problem as to functioning.
- When the servomotor with oil seal is used in the axial direction, make sure that oil has not accumulated at the oil seal lip.

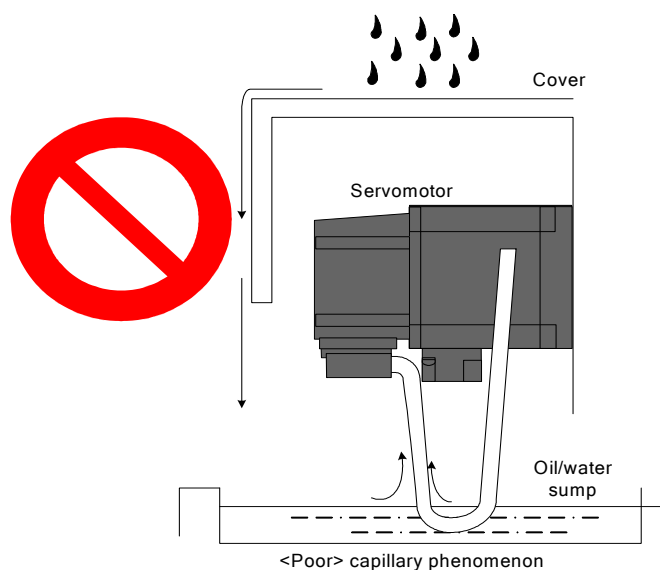

Dimensional tolerances The servomotor is assembled to the following accuracy

Type of Servomotor	Run-out at shaft end	Center Deviation (Flange)	Unit: mm
			Perpendicularity of flange face (Flange)
BSM0100 ÷ BSM0750	≤ 0.02	≤ 0.06	≤ 0.08
BSM1000 ÷ BSM2000	≤ 0.02	≤ 0.06	≤ 0.08

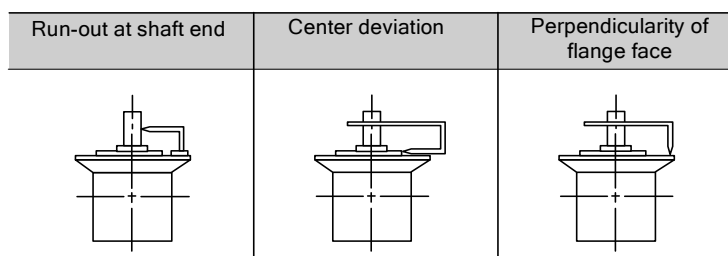

Load The radial load and thrust load exerted on the shaft end of the servomotor are as follows

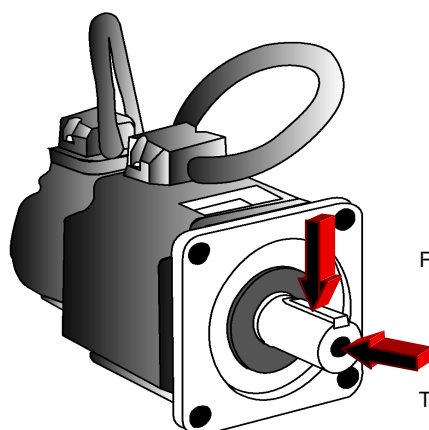

Radial load : Load exerted at right angles to motor shaft

Thrust load : Load exerted in parallel to motor shaft

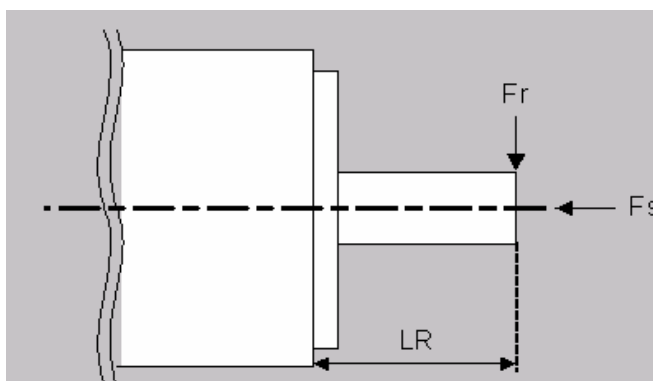

Type of Servomotor	Allowable radial load F_r [N]	Allowable thrust load [N]	L_r [mm]
BSM0100	127	19	25
BSM0200	264	58	30
BSM0400	264	58	30
BSM0750	676	147	55
BSM1000	510	253	55
BSM1500	510	253	55
BSM2000	510	253	55

Servoamplifier

Storage environment Store the servo amplifier in the following environment when leaving it without energization.

Storage temperature : -20 to 85 °C

Storage humidity : 10 to 90% RH (no condensation allowed)

Storage area : Indoors with altitude of 1000 [m] or less

There shall be no dust, corrosive gas or direct sunlight.

Storage pressure: 70 - 106 [kPa]

Vibration/impact : 4.9 [m/s²]/19.6 [m/s²]

Operating environment Operate the servomotor in the following environment.

The servo amplifier is not drip-proof and dust resistant.

Operating temperature : -10 to 55 °C

Operating humidity : 10 to 90% RH (no condensation allowed)

Operation area : Indoors with altitude of 1000 [m] or less

There shall be no dust, corrosive gas or direct sunlight.

Operation pressure : 70 - 106 [kPa]

Vibration/impact : 4.9 [m/s²]/19.6 [m/s²]

- Mounting**
- Mount the servo amplifier in the upright direction so that the “BSD” characters on the Keypad of the servo amplifier look horizontally.



- The servo amplifier has the part that generates heat during operation.

To mount multiple servo amplifiers in the same panel, observe the following precautions.

- Mount side by side in principle. The BSD servo amplifier can be mounted closely. Use the amplifiers at 80% ED rating* if they are installed in contact with each other. There is no limitation in the operation frequency when amplifiers are mounted at 5 mm or larger intervals.
- Reserve 40 mm or a larger distance at the bottom of the servo amplifier.
- 50 mm or a larger distance is necessary above the servo amplifier for heat radiation.

* When the ambient temperature is 45 [°C] or less in close contact, the servo amplifier can be used at 100 [%ED].

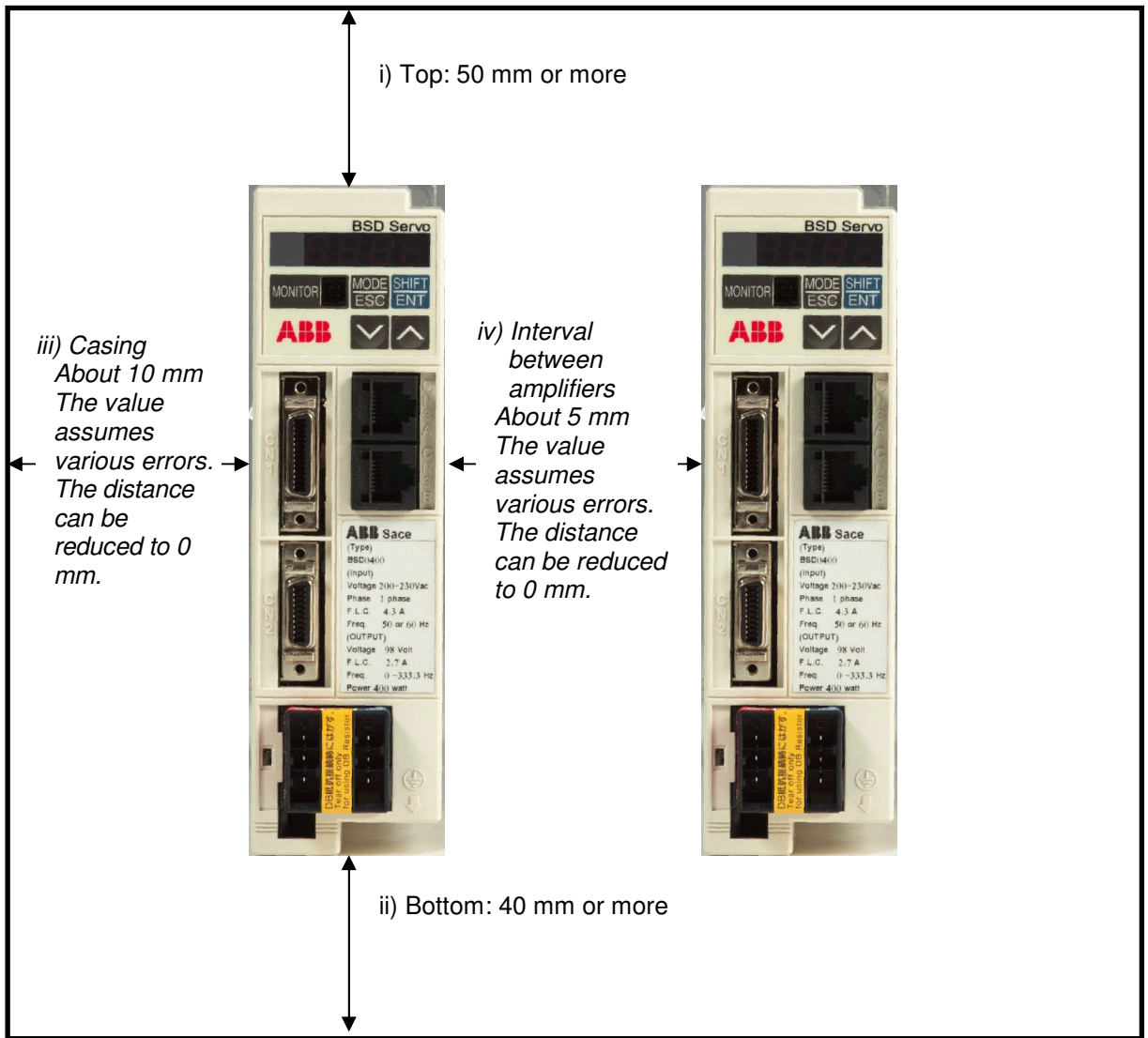

Handling The servo amplifier consists of electronic parts including microprocessors. Do not operate in the following environment.

- Location near oil, steam or corrosive gas
- Location with much dust
- Mount the servo amplifier in an airtight panel equipped with a forced ventilation fan when using it at places with much dust.

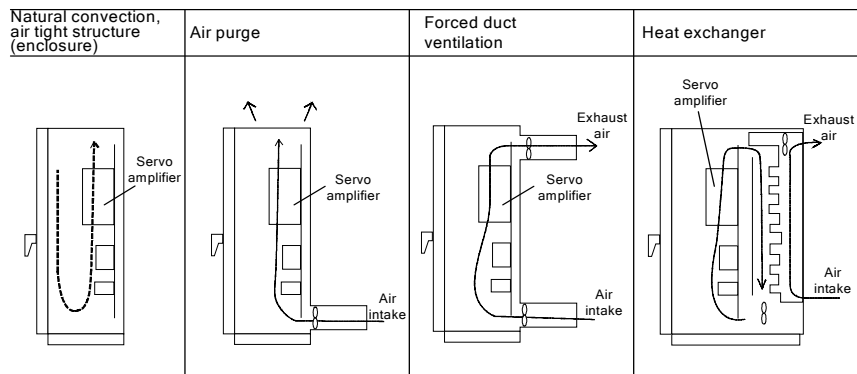

- Location where strong electrostatic or magnetic field exists
- Accommodation in the same panel together with high voltage (3 kV, 6 kV) equipment
- Sharing of the same power supply with the equipment which generates large noise
- Under standing vibration
- In vacuum
- In explosive atmosphere

Power supply to servo amplifier

Supply electric power to the servo amplifier in the specification range.

- Single-phase 200 V: 200 to 230 [VAC] (fluctuation: -10 to +10%)

Servo amplifier capacity: 0.75 [kW] or less

- Three-phase 200 V: 200 to 230 [VAC] (fluctuation: -15 to +10%)

Servo amplifier capacity: 1.0 [kW] or more

Depth of amplifier

When the sequence input/output cable and the encoder cable are attached to the servo amplifier, secure a space of 70 [mm] or more at the front

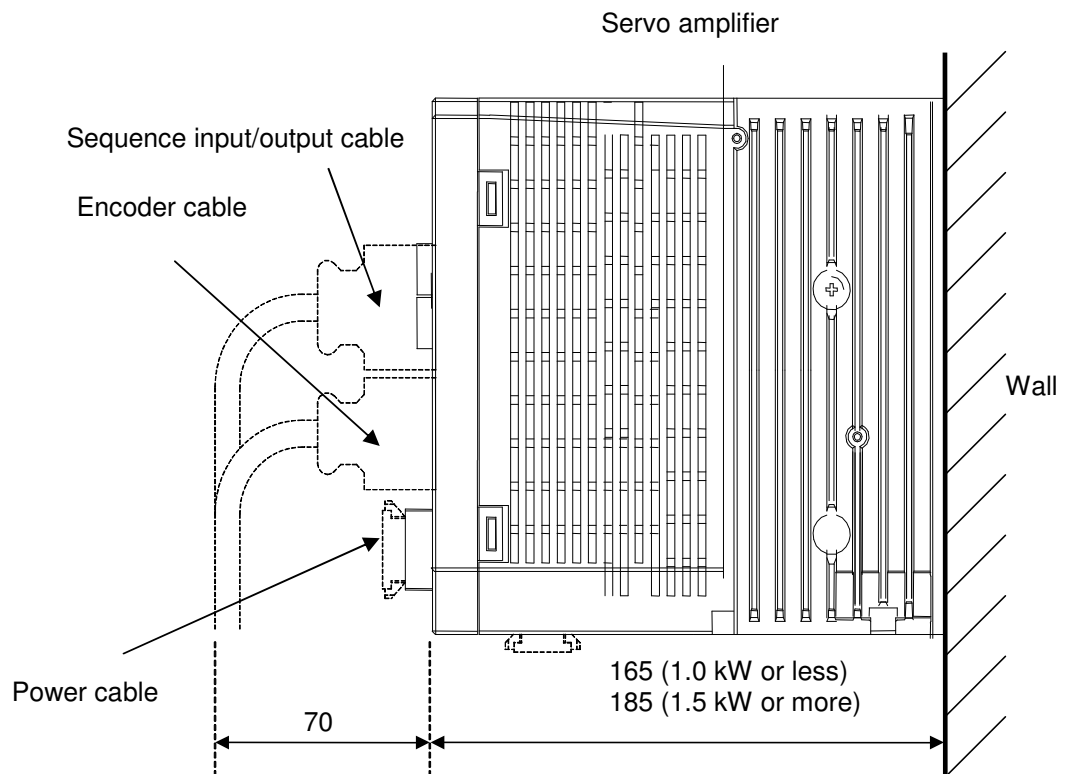

Chapter 3 - Wiring

Configuration

The configuration of BSD Series is as follows.

(1) Servomotor (without brake)

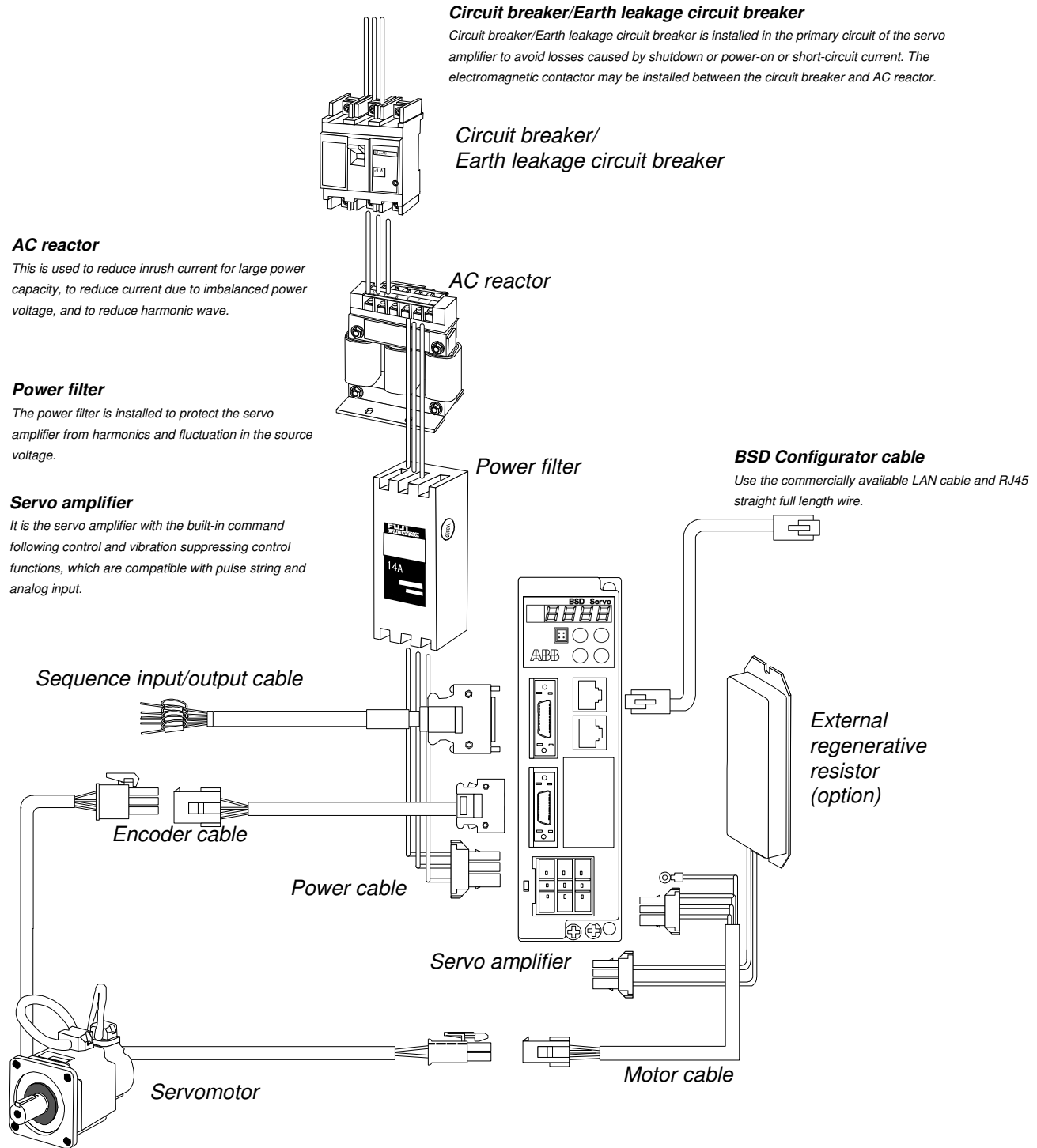

Chapter 3 - Wiring
(2) Servomotor (with brake)

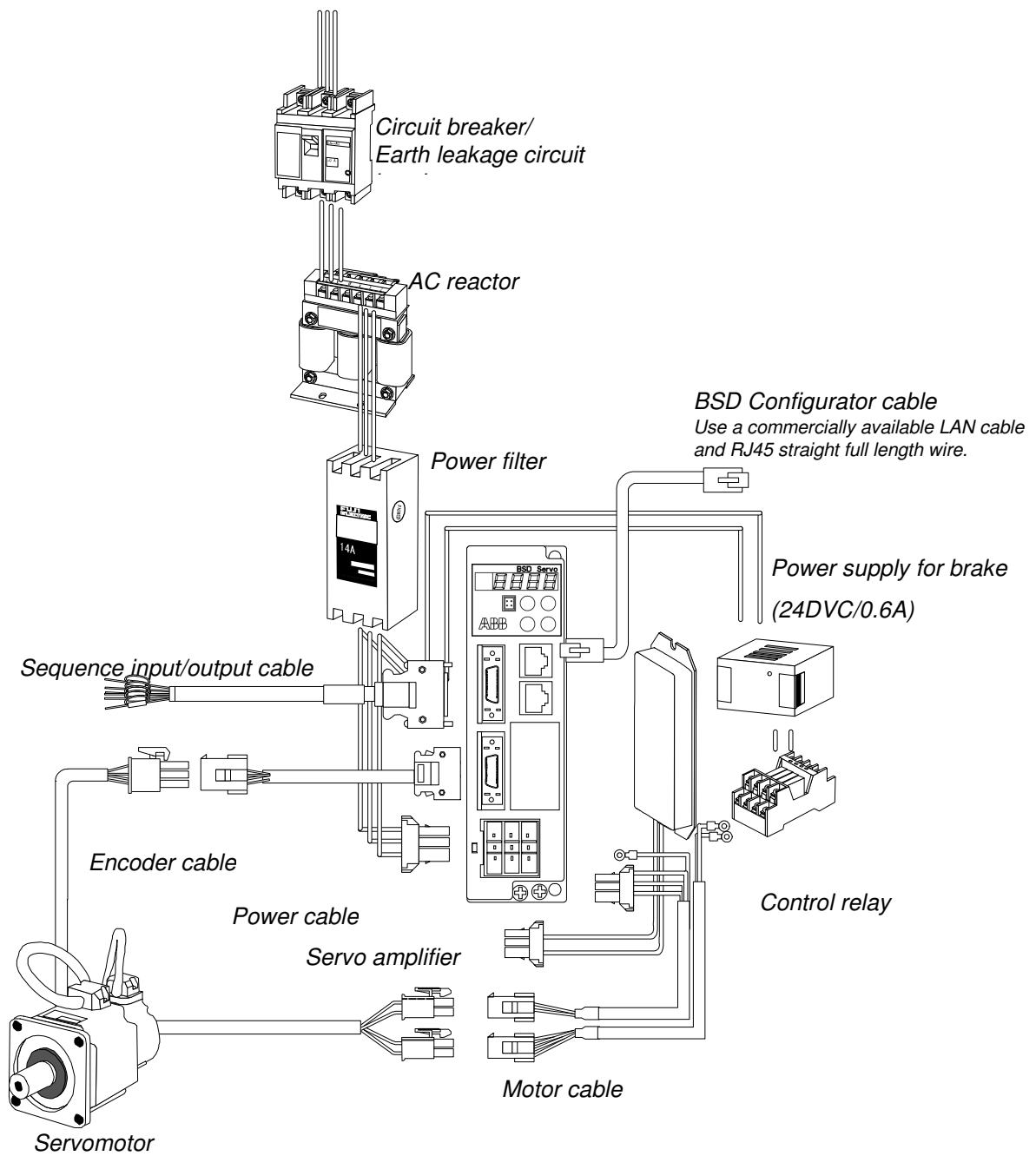

Servo Amplifier

The configuration of BSD Servo amplifier is as follows.

Frame 1

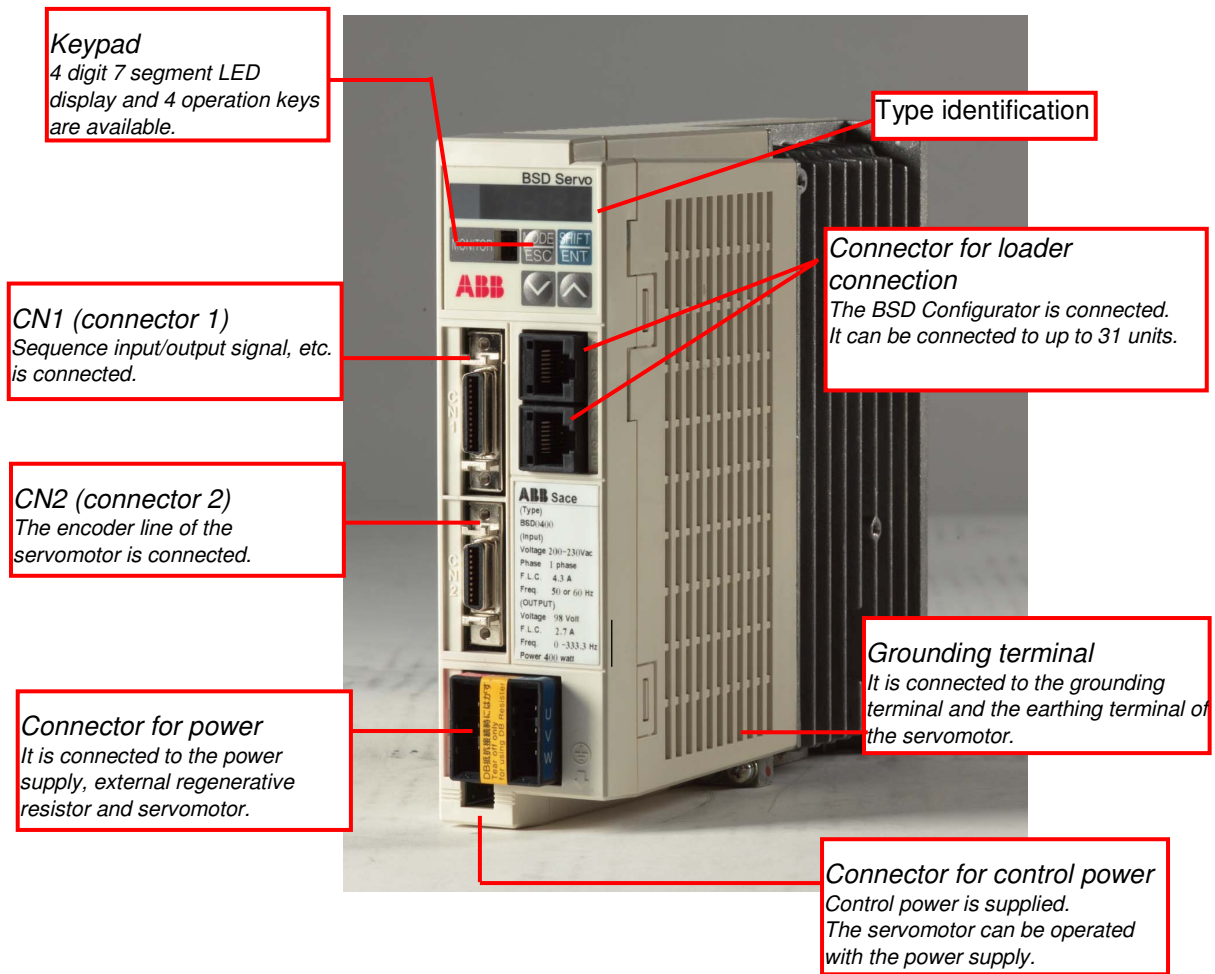

Outer frame	Rated rotation speed	Applicable motor output	Servo amplifier type
Frame 1	3000r/min	0.1kW	BSD0100
		0.2kW	BSD0200
		0.4kW	BSD0400
Frame 2	3000r/min	0.75kW	BSD0750
		1.0kW	BSD1000
Frame 3	2000r/min	1.5kW	BSD1500
		2.0kW	BSD2000

Commercial power supply

Supply the commercial power described in Chapter 12 to the servo amplifier.
 The power from a 400V series is supplied with the voltage stepped down.
 If the commercial power is supplied directly to the servomotor, the motor will be damaged.

Servo amplifier of 0.4kW or less

Supply the single-phase 200V commercial power to the servo amplifier. Connect it to the L1 and L2 terminals.

Voltage: 200 to 230V, -10% to +10%

Frequency: 50/60Hz

Number of phases: Single phase (motor power supply, L1, L2)

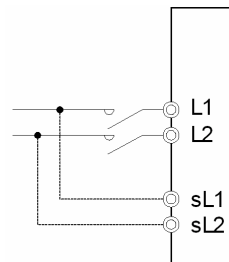

Servo amplifier of 0.75kW

Supply the single-phase 200V or three-phase 200V commercial power to the servo amplifier.

Connect the single-phase power to the L1 and L2 terminals, or the three-phase power to the L1, L2, and L3 terminals.

Voltage: Single-phase 200 to 230V, -10% to +10%

Three-phase 200 to 230V, -15% to +10%

Frequency: 50/60Hz

Number of phases: Single phase (motor power supply, L1, L2)

Three phases (motor power supply: L1, L2, L3)

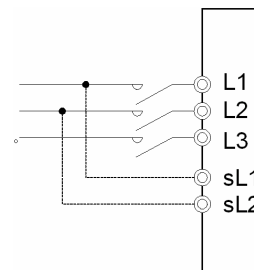
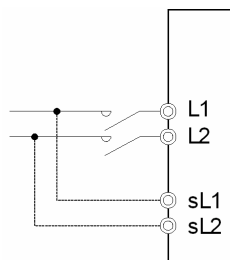

Servo amplifier of 0.85kW or larger

Supply the three-phase 200V commercial power to the servo amplifier.

Connect it to the L1, L2, and L3 terminals.

Voltage: Three-phase: 200 to 230V, -15% to +10%

Frequency: 50/60Hz

Number of phases: Three phases (motor power supply: L1, L2, L3)

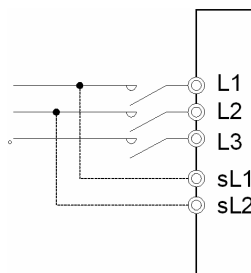

Control power supply (common to all models)

Supply the commercial power of single-phase 200V as the control power supply.

Connect it to the sL1 and sL2 terminals.

Voltage: Single phase 200 to 230V, -10% to +10%

Frequency: 50/60Hz

Number of phases: Single phase (motor power supply, sL1, sL2)

Even if the control power is not used (unwired), the servo amplifier works properly if the motor power is supplied.

When the control power is used, the control circuit remains active even if the motor power is cut off for the purpose of safety in case of emergency. So, you can confirm the alarm status or the current position of the motor.

Note

Precautions to be exercised when supplying the 230V power to the servo amplifier using the neutral point of the power supplied from the 400V series (Y-connection).

① Single-phase 200V series

To use the neutral point of the 400V series power supply to supply the 230V power to the motor power supply (L1, L2) and the control power supply (sL1, sL2), connect the same phase to each of them (Figure 1).

If a different phase is connected, the servo amplifier will be damaged (Figure 2).

Figure 1) Example of correct wiring

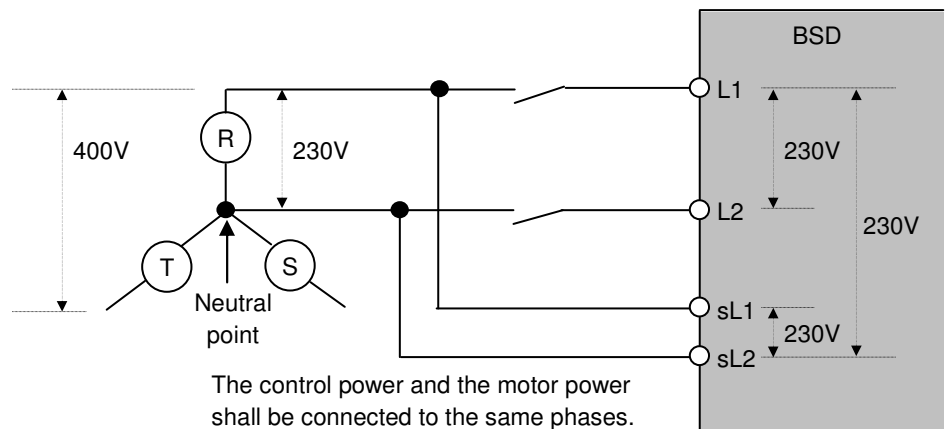
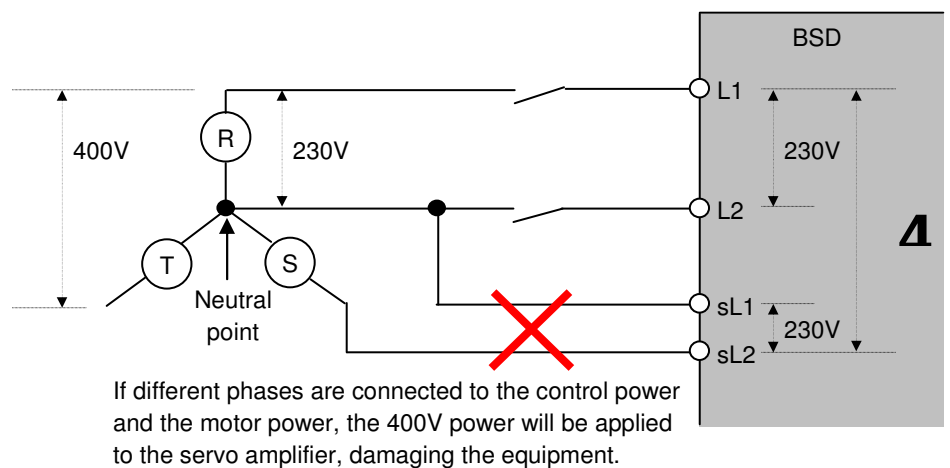
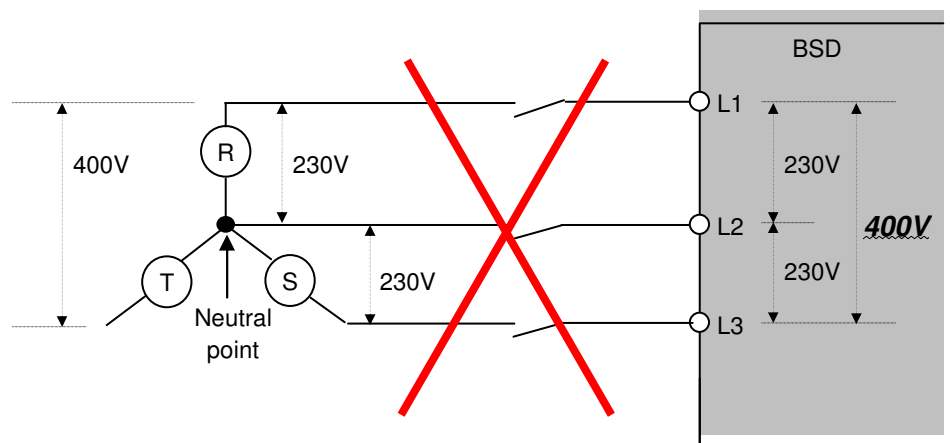

Figure 2) Example of incorrect wiring



② Three-phase 200V series

Do not use the neutral point of the power from 400V series to supply the 230V power to the motor (L1, L2, L3). Failure to follow this instruction will cause damage to the servo amplifier.



Power supply capacity The power supply capacity required for each servo amplifier is as follows. The same power supply capacity applies to the step-up or step-down transformer.

The specified power supply capacity is for the designated cable size and a wiring length of 20m. If the power supply capacity is 500 kVA or more, an AC reactor specified in Chapter 11 should be provided.

(Otherwise the contact of the electromagnetic contactor or the like may melt.)

Motor Power supply (L1, L2)			
Input power supply	Servo amplifier	Applicable motor	Power supply capacity
Single phase 200 V (3000 RPM)	BSD0100	BSM0100xxxx	0.1 kVA
	BSD0200	BSM0200xxxx	0.2 kVA
	BSD0400	BSM0400xxxx	0.4 kVA
	BSD0750	BSM0750xxxx	0.8 kVA
Single phase 200 V (2000 RPM)	BSD1500	BSM1500xxxx	1.5 kVA
Three phase 200 V (2000 RPM)	BSD1000	BSM1000xxxx	1.0kVA
	BSD2000	BSM2000xxxx	2.0 kVA

Action to prevent harmonic wave The multipurpose inverter and the servo amplifier have been excluded from the “Guideline for prevention of harmonic waves in electric appliances and multipurpose products” from January 2004. The procedures to prevent harmonic waves of multipurpose inverters and servo amplifiers are revised from the previous guideline as follows:

All types of multipurpose inverters and servo amplifiers used by a specific user apply to the “Guideline for prevention of harmonic waves by users who receive power at high voltages or especially high voltages”. All users who are requested to apply the guideline should calculate the equivalent capacity or the harmonic wave runoff current according to the guideline. If the harmonic wave current exceeds the limit specified on the contract demand, appropriate action is required. (Refer to JEM-TR 201 and JEM-TR 225.)

Source: Japan Electrical Manufacturers’ Association

Note) The above description is only valid in Japan.

Motor power input/control power input

To connect the motor power input, control power input, external regenerative resistor and servomotor, use the connector or the terminal block.

Since connectors do not accompany the servo amplifier, prepare a connector kit or the wiring cable.

Power wiring is as follows:

Servo amplifier of "connector type"

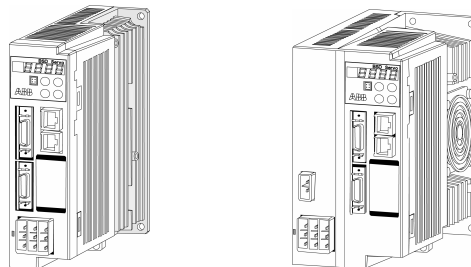

Power wiring	Servo amplifier	Applicable motor
Connector	BSD0100	BSM0100xxx
	BSD0200	BSM0200xxx
	BSD0400	BSM0400xxx
	BSD0750	BSM0750xxx
	BSD1000	BSM1000xxx
Terminal block	BSD1500	BSM1500xxx
	BSD2000	BSM2000xxx

Connector for motor power

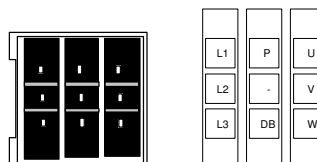

Cable compatible connector (Tyco Electronics AMP)

Receptacle housing : 1-178128-3 (L1, L2, L3)

1-178128-3 (P, DB)

2-178128-3 (U, V, W)

Receptacle contact : 1-175218-5 (Common) * Loose type

1-175196-5 (Common) * Chain type

Connector for control power

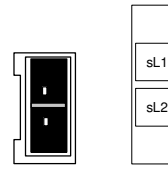

Cable compatible connector (Tyco Electronics AMP)

Receptacle housing : 1-178128-2 (sL1, sL2)

Receptacle contact : 1-175218-5 (Common) * Loose type
1-175196-5 (Common) * Chain type

Manual tool (standard type): 919802-1

Servo Amplifier of "Terminal block type"

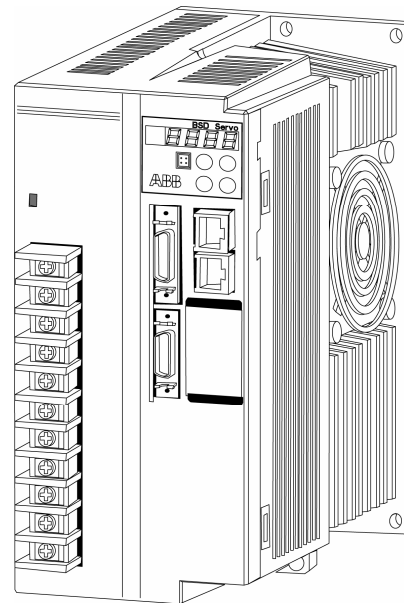
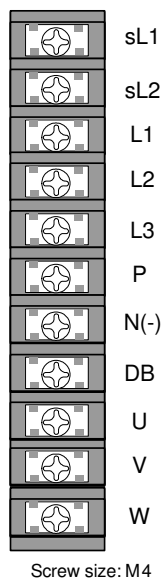

**Sequence input/output
(CN1)**

26	M5	25	FZ	13	M5	12	*FFB
24	*FFZ	23	FFZ	11	FFB	10	*FFA
22	Vref	21	*CB	9	FFA	8	*CA
20	CB	19	PPI	7	CA	6	CONT5
18	OUT4	17	OUT3	5	CONT4	4	CONT3
16	OUT2	15	OUT1	3	CONT2	2	CONT1
14	M24			1	P24		

Connect the signal cable of a host controller to connector 1 (CN1) of the servo amplifier.

Compatible connector on cable side (By Sumitomo 3M)

Soldered plug : 10126-3000VE

Shell kit : 10326-52A0-008

Terminal symbol	Pin No.	Name	Function and meaning
P24 M24	1 14	Power supply for sequence input/output	Power supply input for sequence input/output signals (+24VDC, 0.3A)
CONT1 CONT2 CONT3 CONT4 CONT5	2 3 4 5 6	Sequence input	Sequence input signals. The following signals are allocated by the factory settings. (+24VDC, 10 mA) CONT 1: Operation command (RUN) CONT 2: Reset (RST) CONT 3: (Not specified) CONT 4: (Not specified) CONT 5: (Not specified)
OUT1 OUT2 OUT3 OUT4	15 16 17 18	Sequence output	Sequence output signals. The following signals are allocated by the factory settings. (Max. +30VDC / 50mA) OUT1: Ready (RDY) OUT2: Positioning end (PSET) OUT3: Alarm detection: b-contact (ALMb) OUT4: (Not specified)
PPI CA *CA CB *CB	19 7 8 20 21	Pulse string input	PPI: Power supply input for open collector (24 VDC +5%/-5%) CA, *CA, CB, *CB (max. input frequency: 1 MHz) CA, CB (max. input frequency: 200 kHz) The pulse string form can be chosen from command pulse and sign, forward/reverse rotation pulse, and two signals having 90-degree phase difference.
FFA *FFA FFB *FFB FFZ *FFZ FZ M5	9 10 11 12 23 24 25 26	Frequency dividing output	Frequency dividing output terminals. Two signals having 90-degree phase difference in proportion to the rotation of the servomotor are output. (Differential output) The FZ terminal is an open-collector output. (Max. +30VDC, 50mA) M5: Reference potential
Vref	22	Analog input	Input terminal of analog voltage. The speed command voltage for speed control and the torque command voltage for torque control are input. The standard potential is M5 terminal.

* Terminal M5 is not connected to terminal M24.

Interface circuit diagram

Signal name	Circuit
<p>Sequence input</p> <p><u>Interface specification</u> 24VDC/10mA (per point)</p>	
<p>Sequence output</p> <p><u>Interface specification</u> 30VDC/50mA (max)</p>	
<p>Pulse string input</p> <p><u>Interface specification</u> Differential input (line receiver)</p>	
<p>Pulse string output</p> <p><u>Interface specification</u> Differential output (line driver)</p>	
<p>Pulse string output (Open collector)</p> <p><u>Interface specification</u> 30VDC/50mA (max)</p>	
<p>Analog input</p> <p><u>Interface specification</u> Input impedance 20kΩ</p>	

Wiring example of pulse string input

The pulse string input can be a 12 VDC input. In this case, the wiring method varies. Refer to the drawing in item (3) below

① Differential output devices

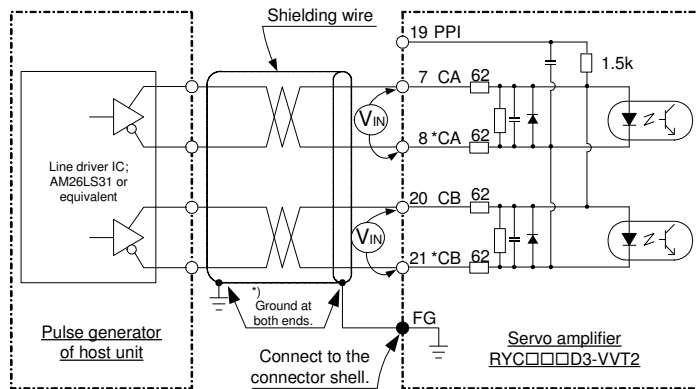

V_{IN} : The voltage amplitude between CA and *CA (between CB and *CB) must be between 2.8 and 3.7V.

(The servo amplifier may not accept the input pulse in other than the specified range.)

② Open collector output devices (24 VDC input)

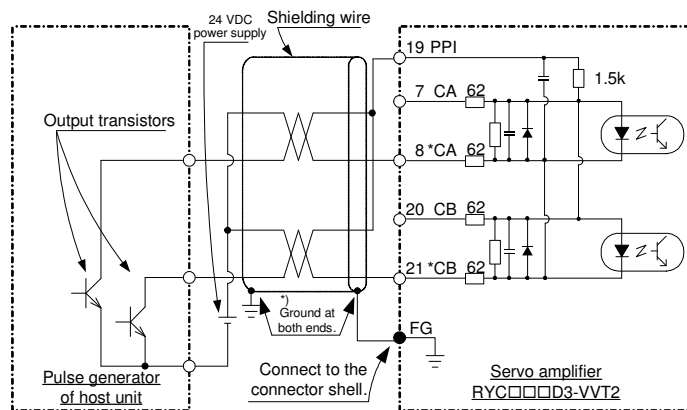

24 VDC power supply: Contain the source voltage within the 24 VDC \pm 5% range.

This circuit consumes a maximum 40 mA current. Prepare a power supply having a sufficient margin.

③ Open collector output devices (12 VDC input)

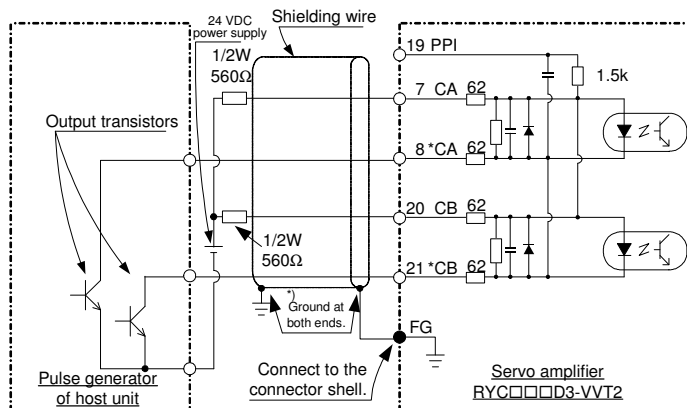

12 VDC power supply: Contain the source voltage within the 12 VDC ±5% range.

This circuit consumes a maximum 40 mA current. Prepare a power supply having a sufficient margin.

*) Ground the shielding wire at both ends with the host unit and the grounding terminal (FG) of the servo amplifier grounded at a single point within the panel. (It may be better to ground the shielding wire at either end when the host unit and the grounding terminal of the servo amplifier are not grounded at a single point.)

Encoder (CN2) Connect the encoder signal of the servomotor to connector 2 (CN2) of the servo amplifier

19	NC	20	FG	9	NC	10	NC
17	SIG+	18	SIG-	7	NC	8	NC
15	NC	16	NC	5	NC	6	NC
13	NC	14	NC	3	P5	4	P5
11	NC	12	NC	1	M5	2	M5

Cable compatible connector (by Sumitomo 3M Ltd.)

Solder plug : 10120-3000VE

Shell kit : 10320-52A0-008

Loader (CN3) Connect the PC to connector 3 (CN3) of the servo amplifier.

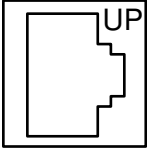
	UP Port	DN Port
	1 P5 (output)	1 NC
	2 M5	2 M5
	3 TXD	3 TXD
	4 *RXD	4 *RXD
	5 RXD	5 RXD
	6 *TXD	6 *TXD
	7 M5	7 M5
	8 P5 (output)	8 NC

Use the signal converter and the commercially available LAN cable (CAT.5 straight full length wire) for connection. 31 servo amplifiers maximum can be connected.

Cable compatible connector (commercially available product) RJ-45

Connect the PC to the UP port (upper) of a servo amplifier.

Then connect the DN port (lower) of the amplifier to the UP port of the next servo amplifier.

Final termination is not required.

Terminal functions and interface

*Pay attention to the order of pin numbers

<Terminals functions>

Pin No.	Pin name	Function
3	TXD	Serial communication output (+)
6	*TXD	Serial communication output (-)
5	RXD	Serial communication input (+)
4	*RXD	Serial communication input (-)

<Interface>

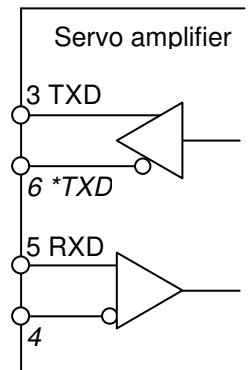

For connection of one or multiple servo amplifiers

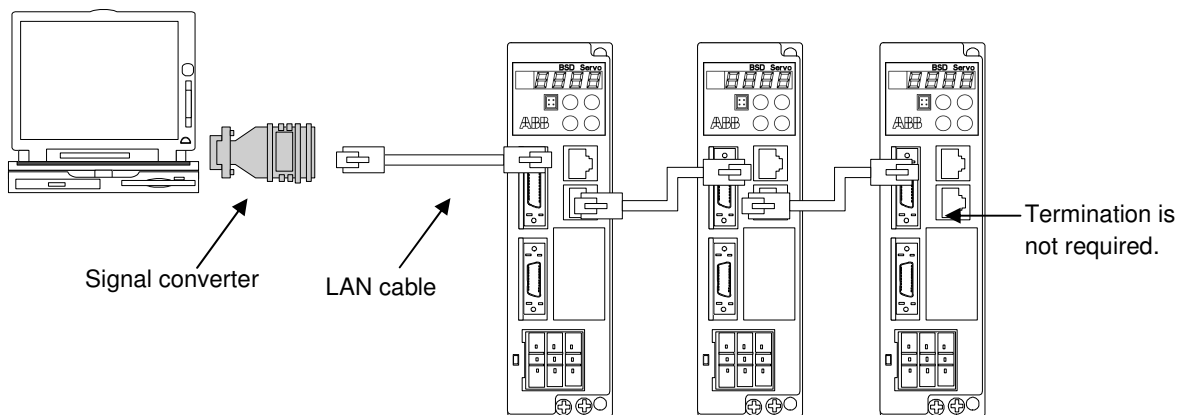

Monitor pin (CN4) Connect the measuring instrument to connector 4 (CN4) of the servo amplifier.

This monitor pin is not required for operation of the servo amplifier and is used for measurement of the servomotor speed waveform and the torque waveform.

CN4 is at the keypad.

Monitor

3	M5	4	M5
1	MON1	2	MON2

Cable compatible connector (by Hirose Electric)

Crimping socket: DF11-4DS-2C

Socket crimping terminal: DF11-2428SC

The output of MON1 and MON2 terminals can be set with the standard parameters. The standard potential is M5 terminal

Servomotor

BSM type 3000 RPM series

The encoder and the power line have lead wires (0.3 m) with connectors.
The protection grade is IP67 except for the shaft thru-hole and the connector.

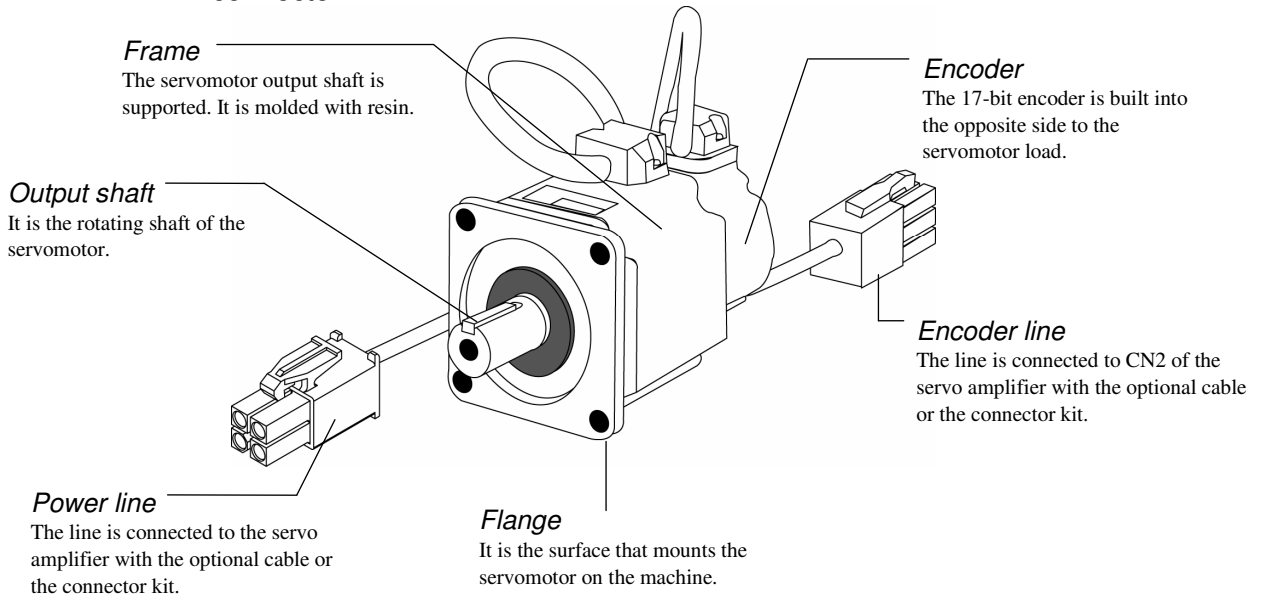

BSM type 2000 and 1500 RPM series

Both the encoder and the power line are connected with canon connectors.
The protection grade is IP67 except for the shaft thru-hole.

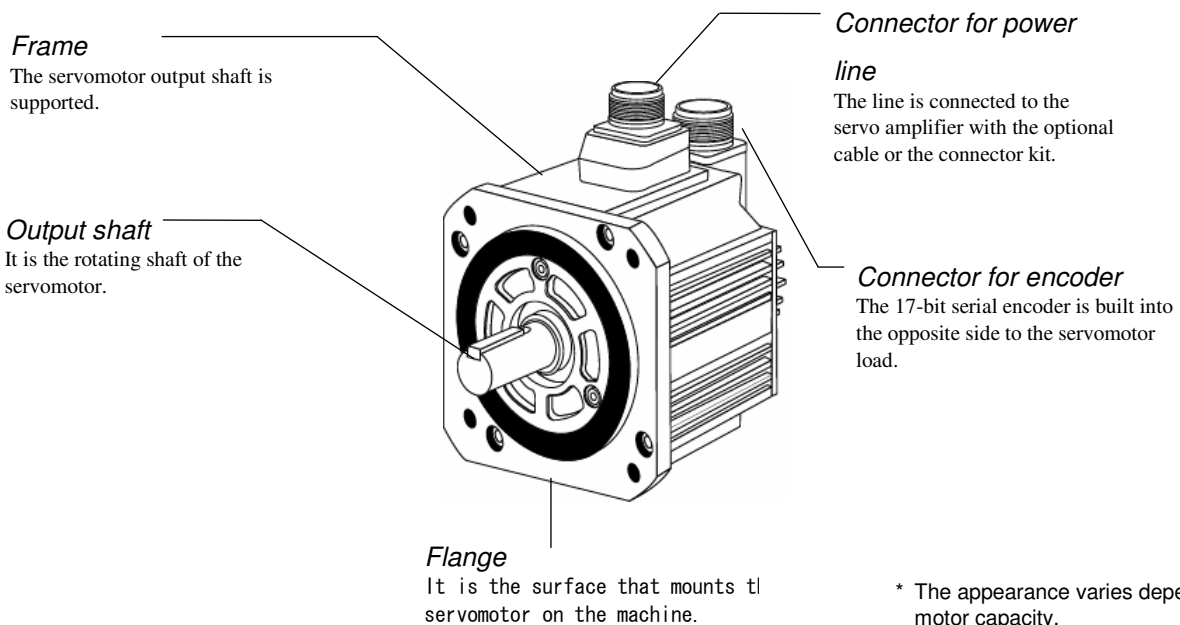

* The appearance varies depending on the motor capacity.

Servomotor Connect the power cable of the servomotor to the U, V and W terminals of the servo amplifier while identifying the symbols.

Do not supply commercial power directly to the servomotor. Otherwise, the motor may be burned.

	<h2>CAUTION</h2>	<p>Do not supply commercial power to the servomotor. Otherwise, the motor may be burned.</p>
---	------------------	---

The direction of rotation of the servomotor cannot be changed by changing the sequence of the servomotor terminals. Change the parameter 4 setting to achieve this.

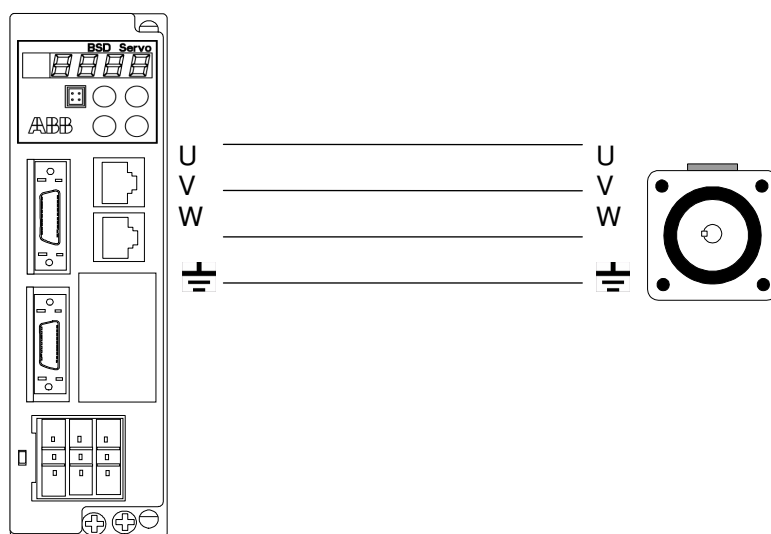

The wiring length between the servo amplifier and servomotor should be within 50 m long.

It is not permitted to perform ON/OFF of the wiring between the servo amplifier and servomotor using magnetic contactors. It is not permitted to turning ON/OFF multiple servomotors with a single servo amplifier.

Furthermore, it is not permitted to connect the following equipment along the wiring between the servo amplifier and servomotor:

- Phase advancing capacitor
- Various reactors
- Noise filter
- Surge absorber

BSM type 3000 RPM series

Motor power cable (Viewed from contact inserting side)

Without brake

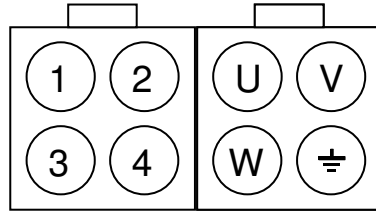

1 cap housing

172159-1-1 type (Tyco Electronics AMP K.K)

4 contactors (socket)

170366-1 type (Tyco Electronics AMP K.K)

Brake power cable (Viewed from contact inserting side)

Brake connector for motor with brake

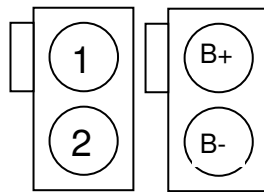

1 cap housing

172157-1 type (Tyco Electronics AMP K.K)

2 contactors (socket)

170366-1 type (Tyco Electronics AMP K.K)

BSM type 2000 RPM series

Motor power wiring (Figure viewed from the plug wiring)

Without brake

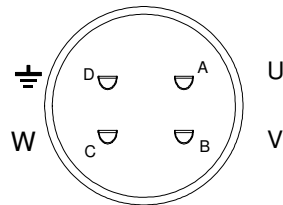

A	U
B	V
C	W
D	⏏

Connector type (L type plug)

MS3108B18-10S type (DDK Ltd.)

Cable clamp

MS3057-10A type (DDK Ltd.)

Motor power wiring (Figure viewed from the plug wiring).

Note) G pin is vacant.

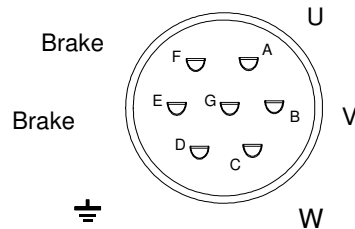

A	U
B	V
C	W
D	⏏
E	Br
F	Br
G	-

Connector type (L type plug)

MS3108B20-15P type (DDK Ltd.)

Cable clamp

MS3057-12A type (DDK Ltd.)

Refer to chapter 2 for straight plug and IP67 compatible connector.

Brake The built-in motor brake is operated with the 24VDC power.

When 24VDC is applied, the brake is released. When the power is shut off, the brake is operated. The brake operation current is 0.6A or less. It is not directly operated with the sequence output signal of the servo amplifier. The brake power supply has no polarity.

Prepare the relay for rated current of 1A or more. The SSR output has polarity.

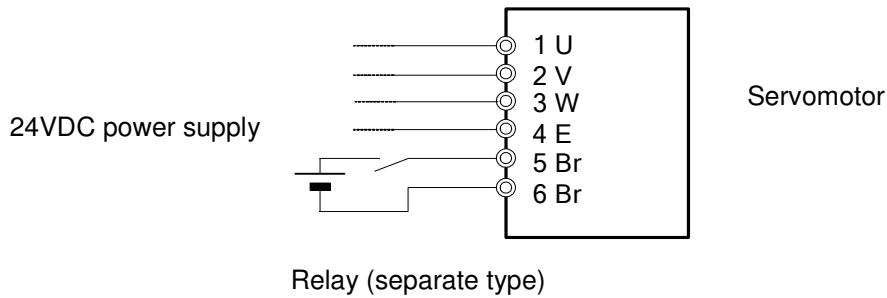

Separately prepare the 24VDC power source for the sequence from the 24VDC power source for the brake.

Encoder The 17-bit encoder is built into the opposite side to the servomotor load.
 The encoder wire is connected to connector 2 (CN2) of the servo amplifier.
 The encoder does not accompany connectors for wiring.

The optional cable with connectors at both ends and the connector kit are available.

The maximum length of the encoder is 50 m and it is restricted by the wiring cable.

BSM models 3000 RPM

Wiring on servo amplifier side

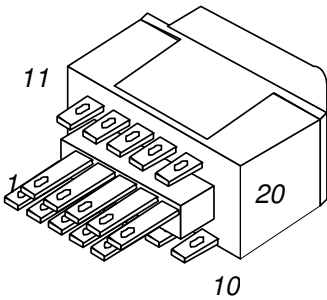

19	NC	20	FG	9	NC	10	NC
17	SIG+	18	SIG-	7	NC	8	NC
15	NC	16	NC	5	NC	6	NC
13	NC	14	NC	3	P5	4	P5
11	NC	12	NC	1	M5	2	M5

Cable compatible connector
 (figure viewed from connector wiring)

Solder plug : 10120-3000VE
 Shell kit : 10320-52A0-008

* By Sumitomo 3M Ltd.

Wiring on servomotor side

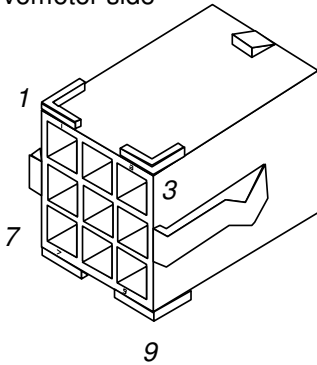

1	NC	2	NC	3	FG
4	SIG+	5	SIG-	6	NC
7	P5	8	M5	9	NC

Cable compatible connector
 (figure viewed from terminal insertion)

Cap housing : 172161-1
 Terminal socket :
 170365-1 (SIG+, SIG-, FG)
 170366-1 (P5, M5)

* By Tyco Electronics AMP K.K

Dedicated crimp tool (manual)
 755330-1

Dedicated pin terminal pulling tool
 189727-1

BSM models 2000 RPM

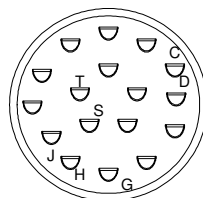

Cable compatible connector
 (figure viewed from wiring)

Connector type (L shaped plug)
 Type: MS3108B20-29S
 (DDK Ltd.)

Cable clamp
 Type: MS3057-12A (DDK Ltd.)

Wiring cable Use the following cables if the optional encoder cable is not used.

It is a normal twisted pair total shielded wire.

If the motor and the cable are not moving, it is not necessary to use a flexible cable:

- Cross-link polyethylene insulated, vinyl sheath cable for robot travel
- (Wire length exceeds 20m and is 50m or less.)

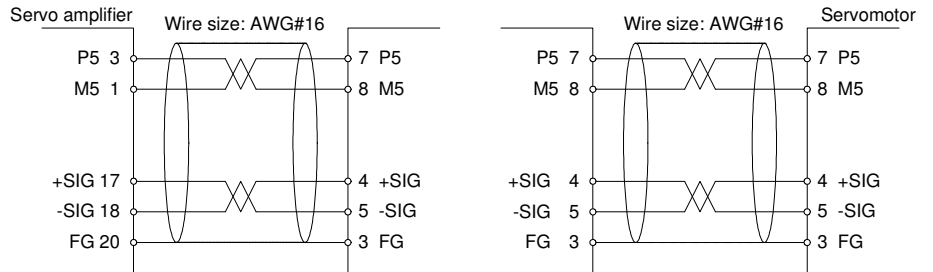
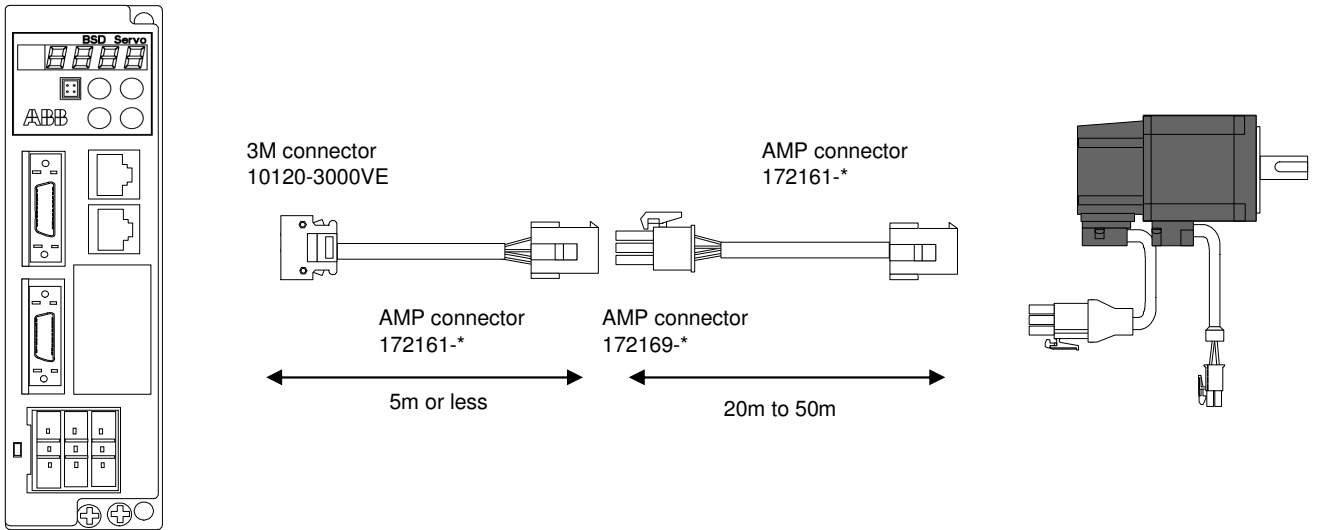

Cable size See the following table for conversion between AWG and mm sizes

Gauge		SI unit		Inch unit	
A.W.G	mm ² conversion	Diameter [mm]	Sectional area [mm ²]	Diameter [mil]	Sectional area [CM]
16	1.25	1.291	1.309	50.82	2583
17		1.150	1.037	45.26	2048
18		1.024	0.8226	40.30	1624
19		0.9116	0.6529	35.89	1288
20		0.8118	0.5174	31.69	1021
21		0.7229	0.4105	28.46	810.0
22		0.6438	0.3256	25.35	642.6
23		0.5733	0.2581	22.57	509.4
24		0.5106	0.2047	20.10	404.0
25		0.4547	0.1623	17.90	320.4
26		0.4094	0.1288	15.94	254.1
27		0.3606	0.1021	14.20	201.6
28		0.3211	0.08097	12.64	159.8
29		0.2859	0.06425	11.26	126.8
30		0.2546	0.05097	10.03	100.6

Preparation method of encoder cable

- 1) Do not provide a relay terminal block between the servo amplifier and the servomotor.
- 2) Use a shielded wire.
- 3) Connect the end of the shielded wire to the connector pin

For transmission between the servo amplifier and the encoder, high speed serial communication is used. To obtain reliability of the serial communication, it is important to shield the cable (connectors at both ends).

Perform shielding according to the procedure below:

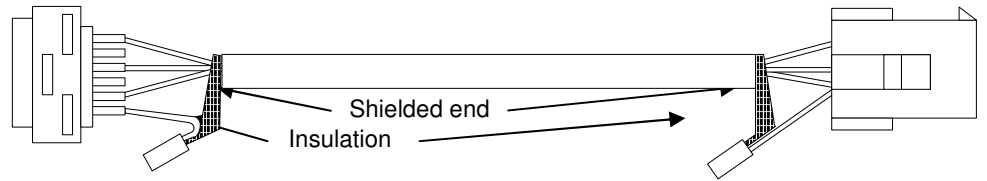

- 4) Connect the corresponding contactor to each encoder signal name.

Pin No.	Signal name	Contactor model
3	FG	170365-1
4	SIG+	170365-1
5	SIG-	170365-1
7	P5	170366-1
9	M5	170366-1

- 5) If the wiring is not more than 20 meters long, connect it as shown below:

- ① Use a twisted pair wire for each pair of a signal and a power supply.
- ② Connect two sets of wires to P5 and M5.
- ③ Connect the shielding wire to terminal #20 of the amplifier connector and to terminal #3 of the motor connector.

Cable model: RMCV-SB-A (UL2464)
 Manufacturer: DAIDEN Co., Ltd.
 Summary of specifications: AWG#24/3P (twisted-pair type)

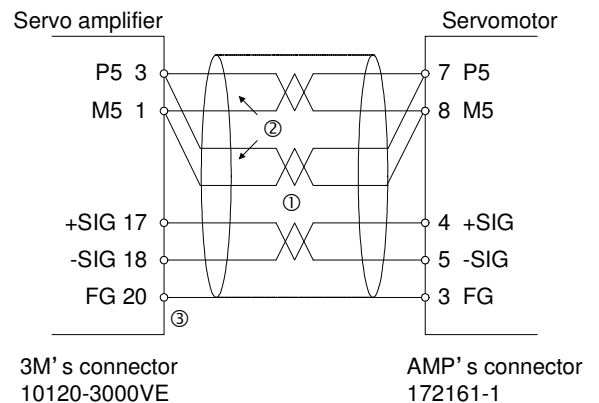

6) Allow for voltage drop of the cable

The encoder consumes a current of approx. 200 mA.

When the wire resistance of the encoder is 1.59Ω or less, the encoder can be operated.

Considering the voltage drop of the cable, the relationship of the wire length (L) between the servo amplifier and the servomotor for the conductor resistance is as shown in formula ①.

$$\text{Wire length (L [m])} \leq \frac{1.59 [\Omega]}{\text{Conductor resistance } [\Omega/\text{km}]} \times 1000[\text{m}] \times \frac{1}{2^*} \dots \text{Formula ①}$$

* The reason for the voltage drop is two wires of P5 and M5.

<Example> When the wire resistance of AWG24 is 85.9 Ω/km (*1), with formula ①

$$\text{Wire length (L [m])} \leq \frac{1.59 [\Omega]}{85.9 [\Omega/\text{km}]} \times 1000[\text{m}] \times \frac{1}{2^*} = 9.25[\text{m}]$$

Therefore, Wire length (L [m]) ≤ 9.25 [m]

When the distance between the amplifier and the motor is 9.25 m or less, the encoder can be used. Determine the encoder wire length after checking the maximum conductor resistance (Ω/m) with your cable.

*1: For bridging wire AWG24 by Hitachi Cable, the maximum conductor resistance is 0.0859Ω/m.

Connection diagrams Connection diagrams of the servo amplifier are shown here

- (1) 3000 r/min series 0.1 kW - 0.4 kW
- (2) 3000 r/min series 0.75 kW
- (3) 2000 r/min series 1 kW - 2 kW

- The servomotor shows the wiring diagram of the motor with a brake. The servomotor without a brake does not have No. 5 and 6 terminals or E, F and G terminals.
- Refer to Section 3.6 for the connection of other devices.
- The sequence input/output terminal initial values of the servo amplifier are as follows:

Settings before shipment from factory

CONT1: Servo ON	OUT1 terminal: Servo ready
CONT2: Alarm reset	OUT2 terminal: Positioning end
CONT3: (Not specified)	OUT3 terminal: Servo alarm (b contact)
CONT4: (Not specified)	OUT4 terminal: (Not specified)
CONT5: (Not specified)	

- Connector 4 (CN4) is not required for operation of the servomotor. It is used for measurement of the servomotor speed waveform and the torque waveform using measuring instruments.
- The control power input terminal (sL1, sL2) is connected to perform parameter editing while the motor power is shut off. The servo amplifier is only operated with the motor power supply.
- Do not use the 24VDC power for both sequence input/output and the brake. When the brake is released, the voltage may suddenly increase. Also use a surge absorber.

(1) 3000 r/m series 0.05 kW - 0.4 kW
 Input power supply : Single phase 200 - 230V
 Motor power wiring : Connector

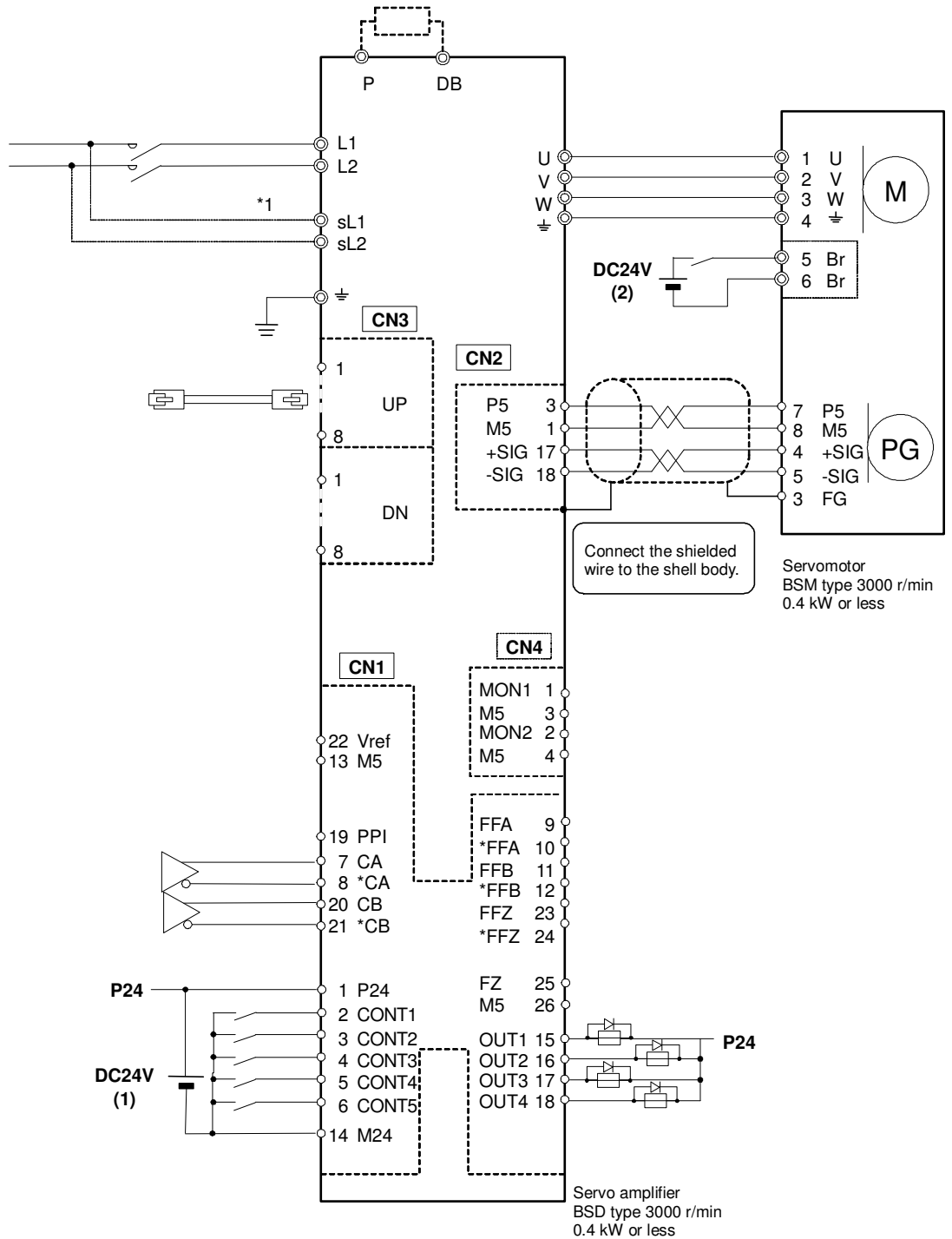

(2) 3000 r/m series 0.75 kW

Input power supply : Single phase 200 - 230V or 3 phase 200 - 230V
 Motor power wiring : Connector

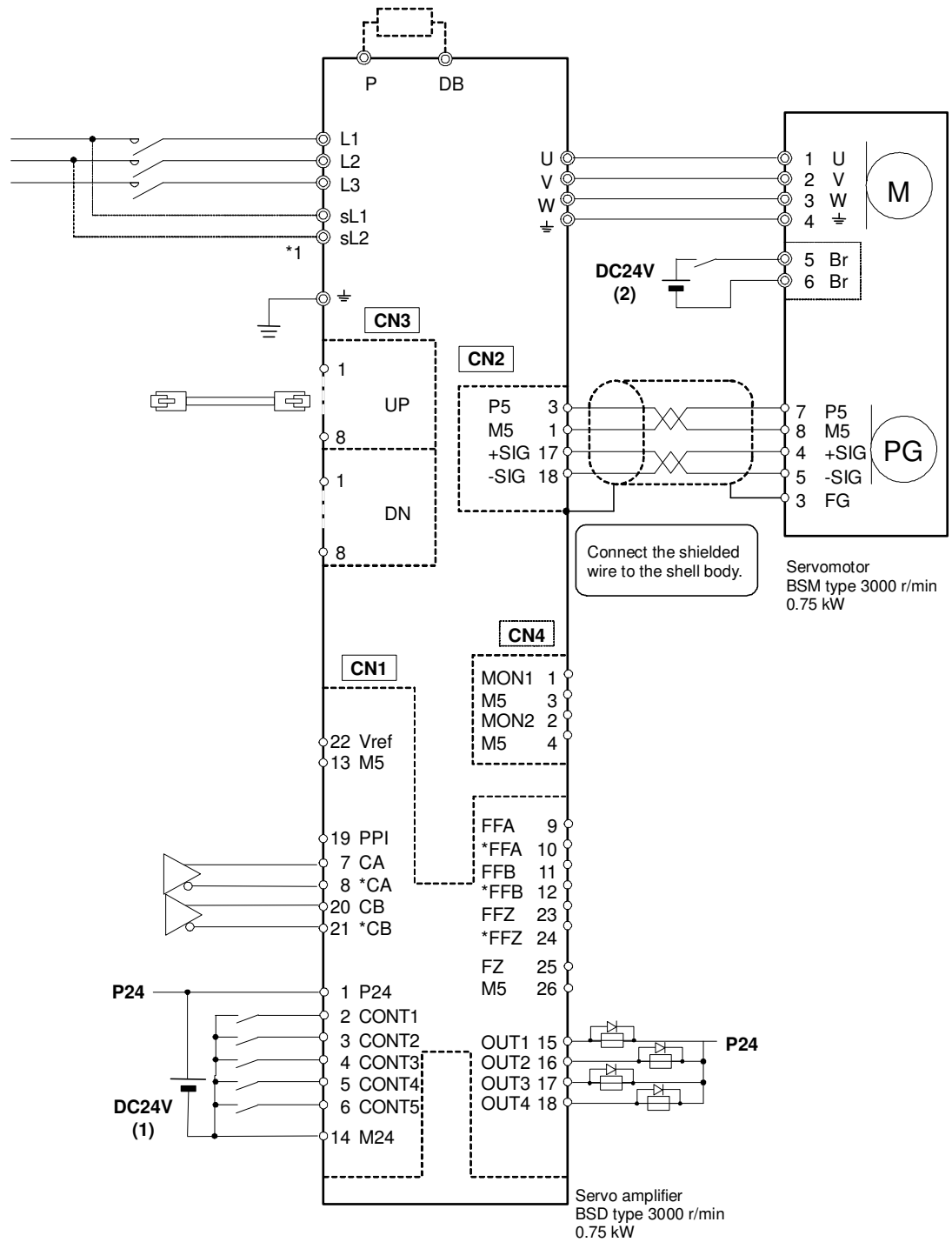

(3) 2000 r/m series 1 kW - 2 kW

Input power supply : 3 phase 200 - 230V

Motor power wiring : Connector (1 kW), terminal block (1.5 kW, 2 kW)

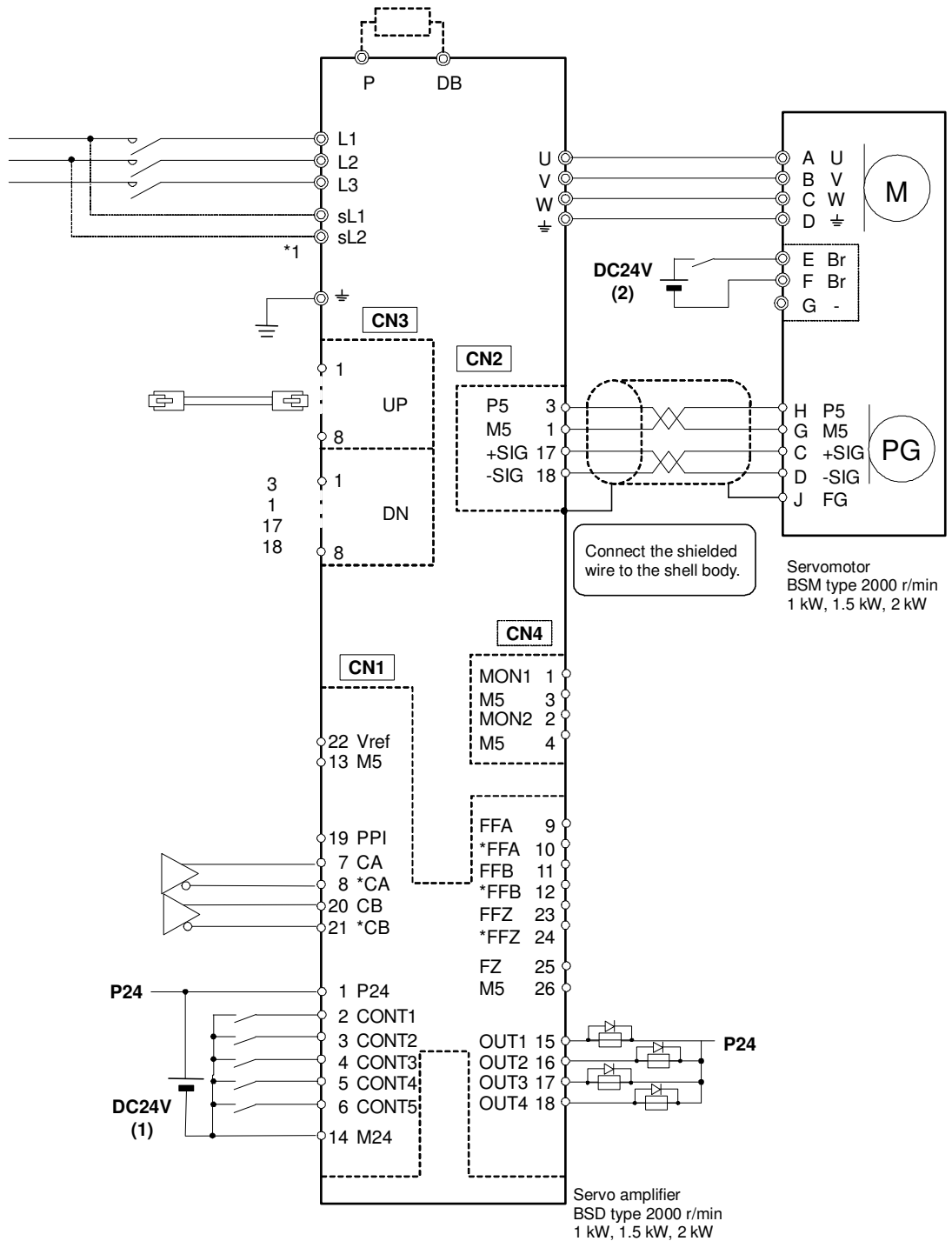

*1) For the precautions about the wiring of the control power supply, see page 3-7.

Chapter 4 – Test Operation

Check items for power supply

When the power is supplied to the servo amplifier for the first time, check the following.

The largest cause of faulty operation of the servomotor is a simple wiring error. Make sure to check the following points before power supply.

Check items before power supply for the first time

Items to be checked	Check
Is the correct power source connected to the servo amplifier power input?	
Is the servomotor power connector correctly connected?	
Is the encoder connector (CN2) correctly connected?	
Is the sequence input/output connector (CN1) correctly connected?	
Is the regenerative resistor correctly connected? *1	
Is the brake wiring correctly connected? *2	
Are the servo amplifier and the servomotor securely grounded?	
Are the CN1 and CN2 shield wires securely grounded?	
Are cables exposed to undue force or are they extremely sharply bent?	
Are signal wires or power cables short-circuited due to dust or metal powder?	
Are screws loose in the servomotor mounting area or in the machine?	

*1) Check it only when the regenerative resistor is connected.

*2) Check it only when a motor with a brake is used.

When all checks above are completed, supply the power to the servo amplifier

Check items when power is supplied for the first time

Items to be checked	Check
Is the display on the keypad correct?	
Are I/O signals correct (in particular, forced stop, \pm OT signals)?	

Test operation in three stages

Perform test operation in the following three stages

First stage

Perform test operation with the servomotor and the servo amplifier

- ① Check input power supply/motor power/encoder wiring.
- ② Check rotation direction of the servomotor.

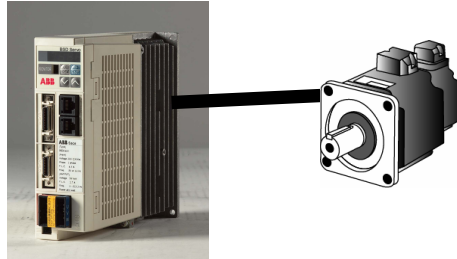

Note

To proceed to the 2nd stage, make sure to turn off the power before starting work.



Second stage

Connect the upper level control system to the servo amplifier and perform test operation with the command from the upper level control system.

- ① Check wiring with the upper level control system.
- ② Check I/O signals.
- ③ Check the rotation speed and rotation level of the servomotor.

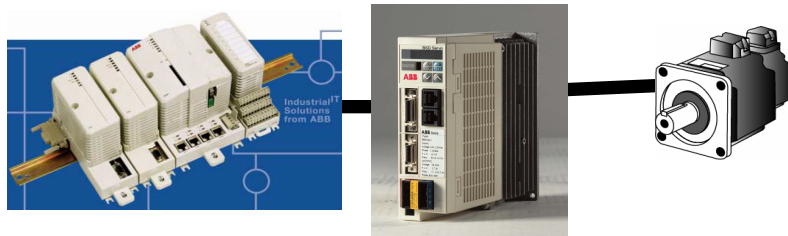

Note

To proceed to the 3rd stage, make sure to turn off the power before starting work.



Third stage

Connect the upper level control system to the servo amplifier and mount the servomotor on the machine. Then, perform test operation.

- ① Check that the servomotor is correctly installed on the machine.
- ② Check the travel distance of the machine.



First stage Connect the servo amplifier and servomotor to perform test operation. Refer to Chapter 3 for the wiring method.

Perform test operation of the servomotor output shaft without connecting to the machine.

Check the following items in the first stage.

<Check>

- (1) Check the power supply wiring of the servo amplifier (L1, L2 and L3).
- (2) Check the servomotor power cables (U, V and W) and encoder cable.
- (3) Check if the servo amplifier and servomotor function correctly.
- (4) Check parameter #4 (rotation direction switching/phase switching for rotation in CCW direction)

Test operation procedure (1) Fix the servomotor so that it will not fall

Mount nothing on the motor shaft.

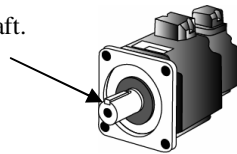

Fix securely.

(2) Referring to Chapter 3, connect cables to the servo amplifier and the servomotor.

* In the first instance, the test operation is performed in individual unit. Do not connect CN1.

- (3) After checking items listed under "Check items before power supply for the first time" on page 4-2, supply the power
 - i) Check LED for charge.
 - ii) Check touch panel display.

i) Check the charge LED.
Red LED lights up in the normal state.

* If an alarm is detected, turn the power off, check wiring, and refer to Chapter 9.



ii) Check the touch panel indication.

When correct	
When faulty	Alarm detection (letters are blinking)

- (4) Perform test operation from the keypad and the BSD Configurator. Use the keypad to turn the servomotor. Check that the servomotor turns in the correct direction.

Basic setting parameter #04

No.	Name	Setting range	Initial value	Change
04	Rotation direction switching/phase switching for rotation in CCW direction	0 : Positive direction forward rotation (CCW)/B phase advance 1 : Positive direction reverse rotation (CW)/B phase advance 2 : Positive direction forward rotation (CCW)/A phase advance 3 : Positive direction reverse rotation (CW)/A phase advance	0	Power

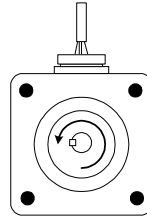

Forward rotation (CCW)

If no fault is found in the first stage, go to the second stage.

Test operation at keypad

Use the MODE key to start the test operation mode.

The servomotor rotates while the key on the keypad is held down. The servomotor rotates at the speed specified at parameter #31 with the acceleration and deceleration time specified at parameter #35/36.

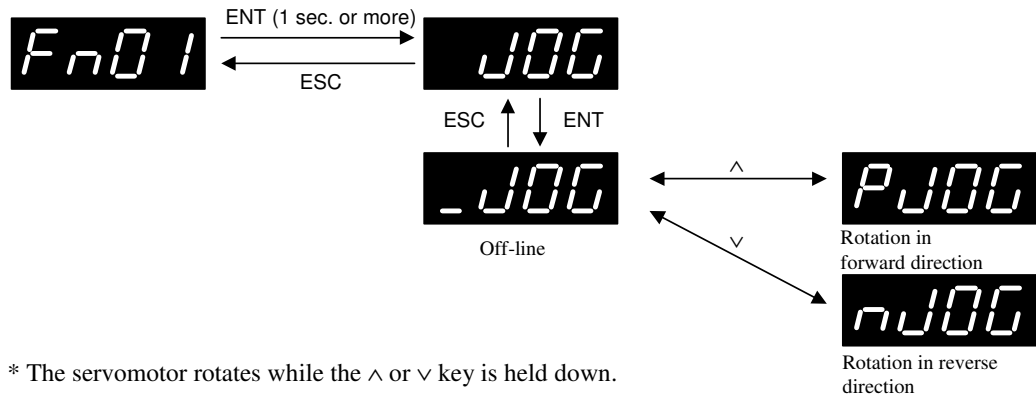

No.	Name	Setting range	Initial value	Change
31	Manual feed speed 1 (and test operation)	0.1 to maximum rotation speed [r/min] (in 0.1 increments)	100.0	Always
35	Acceleration time (and test operation)	0.000 to 9.999 sec. (in 0.001 increments)	0.100	Always
36	Deceleration time (and test operation)	0.000 to 9.999 sec. (in 0.001 increments)	0.100	Always

Second stage Connect the upper level control system to the servo amplifier and perform test operation with the command from the upper level control system. Refer to Chapter 3 for wiring. Perform test operation without connecting the servomotor output shaft to the machine.

Common for all control (position/speed/torque) modes In the 2nd stage, check the following items.
Then, check parameters for each control mode.

<Check>

- (1) Check wiring of signal wires between the servo amplifier and the upper level control systems
- (2) Check I/O signals

- Test operation procedures*
- (1) According to wiring in Chapter 3, connect the servo amplifier (CN1) to the upper control system.
 - (2) Check I/O signals from the keypad or the BSD Configurator.
In particular, check forced stop (EMG), \pm overtravel (\pm OT) and brake timing which are protective functions. Check that the servo amplifier is recognizing each signal.

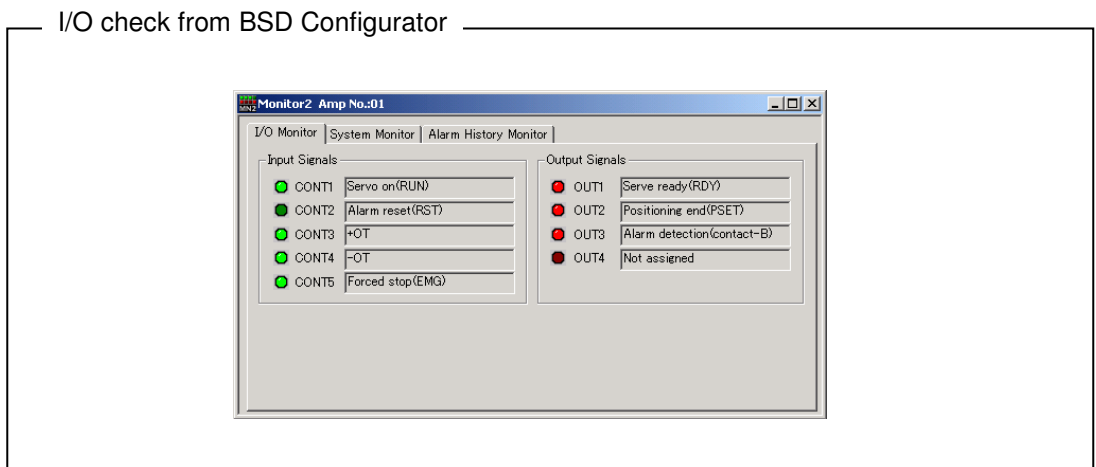
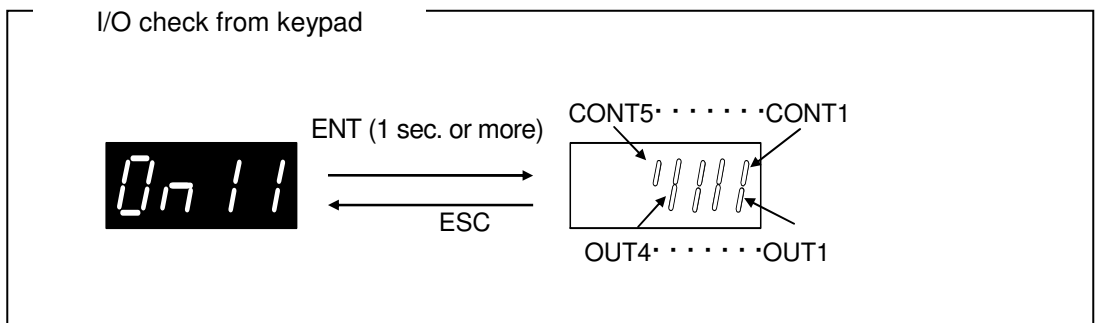

Position control mode Set parameters for the pulse command from the upper level control systems.

<Check>

- (1) Check the pulse output circuit and the wire of the upper level control system.
- (2) Check parameters of the servo amplifier.

Test operation procedures

- (1) Wiring varies when the pulse output circuit * of the upper level control system is ① Differential output or ② Open collector output. Check the output circuit and the wiring.

* Refer to the operation manual on the upper level control system.

① Connection method for differential output

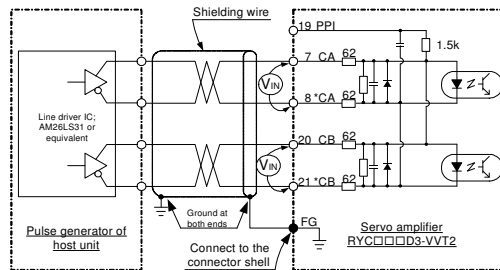

② Connection method for open collector output. Example for DC24V input

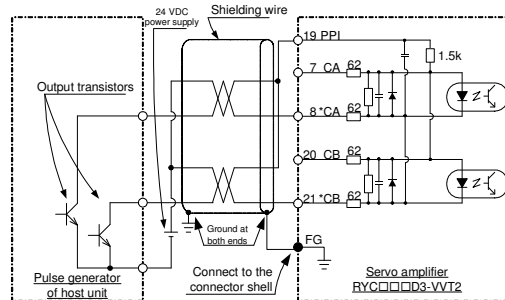

Refer to Chapter 3 for wiring

- (2) Supply the power and check the pulse output from the upper level control system, settings of the command pulse compensation α/β (electronic gear) and the control mode (Parameters: #1 to 4, 9).

No.	Name	Setting range	Initial value	Change
01	Command pulse correction α	1 to 32767 (in 1 increments)	16	Always
02	Command pulse correction β	1 to 32767 (in 1 increments)	1	Always
03	Pulse string input form	0 : Command pulse and command sign 1 : Forward or reverse rotation pulse 2 : Two signals with 90-degree phase difference	1	Power
09	Control mode switching	0: Position, 1: Speed, 2: Torque, 3: Position↔Speed, 4: Position↔Torque, 5: Speed↔Torque	0	Power

- (3) Turn ON the operation command (RUN) and make the system ready for rotation. Then output a pulse from the upper level control system to operate the motor. At this time, check the rotation speed, the movement in the rotation direction and the rotation direction of the motor.

① Check rotation speed

Check the touch panel monitor (On01).

② Calculation method of motor rotation speed from input frequency

$$\text{Rotation speed [r/min]} = \text{Input frequency [Hz]} \times \frac{60}{131072} \times \frac{\text{Command pulse compensation } \alpha}{\text{Command pulse compensation } \beta}$$

③ Calculation method of feed speed from motor rotation speed

$$\text{Feed speed [mm/s]} = \frac{\text{Rotation speed [r/min]}}{60} \times \text{Movement per rotation [mm]}$$

④ Check method of movement

Check the current feedback position of the touch panel. (This value indicates the servomotor rotation in unit after pulse compensation.)

Check that the value of the current command position is the same as the value of the current feedback position.

⑤ Check rotation direction

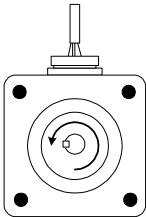

Forward direction (CCW)

- (4) When the items above are checked, turn OFF the operation command (RUN) and shutoff the power supply.

Now, the 2nd stage test operation in the position control mode is completed

Troubleshooting The motor does not rotate.

<Check>

- Check wiring with the upper level control system.
- Check with the keypad of the servo amplifier that the servomotor is ready for rotation.
- Check that the upper level control system is correctly giving pulses.
- Check the input cumulative pulses

Items to be checked	Description of check	Check
1. Which is the circuit for the pulse string output of the upper level control system?	1 : Open collector output 2 : Line driver output	
2. Is connection of the pulse string input correct?	Check "Wiring" in Chapter 3.	
3. Which is the pulse string output of the upper level control system?	0 : Command pulse/command symbol 1 : Forward rotation pulse/reverse rotation pulse 2 : 90 degree phase difference 2 signal	
4. Are the pulse string output in "3" and the reference value of parameter #3 (pulse string output) correct?	Reference value of parameter #3	
5. Are the setting of parameters #1 and #2 (command pulse compensation α , β) correct?	Reference values of parameters #1 and #2	
6. Is the reference value of parameter #9 (control mode switching) "0: Position control"?	Setting value of parameter #9	
7. Is the rotation direction according to the command?	Setting value of parameter #4	
8. Is the rotation speed according to the command?	Check the keypad.	
9. Is the number of output pulses from the upper level control system equal to the number of the command cumulative pulses of the servo amplifier?	Check the keypad.	

Speed/torque control mode

Set parameters for the analog command from the upper level control system

<Check>

- (1) Check wiring of the analog input.
- (2) Check parameters of the servo amplifier.

Test operation procedures

- (1) Check that the analog output from the upper level control system is correctly wired to the analog input terminal (Vref) of the servo amplifier

Refer to Chapter 3

- (2) Supply the power and check the control mode and the analog command gain (Parameters: #9, 70)

No.	Description	Setting range	Initial value	Change
09	Control mode switching *	0: Position, 1: Speed, 2: Torque, 3: Position↔Speed, 4: Position↔Torque, 5: Speed↔Torque	0	Power
70	Analog command gain	±0.10 to ±1.50 (in 0.01 increments)	1.00	Always

* When the control mode is set to "1: Speed control," the Vref terminal is the speed command

terminal. When it is set to "2: Torque control," the terminal is the torque command terminal.

- (3) Allocate the manual forward (FWD) to the CONT3 signal of parameter #12, and manual reverse (REV) to the CONT4 signal of parameter #13. After the setting is completed, turn ON the power again.
- (4) Turn ON the run command (RUN) of the CONT1 signal and either manual forward (FWD) or manual reverse (REV) of the CONT3 signal. The servo amplifier is ready to run.

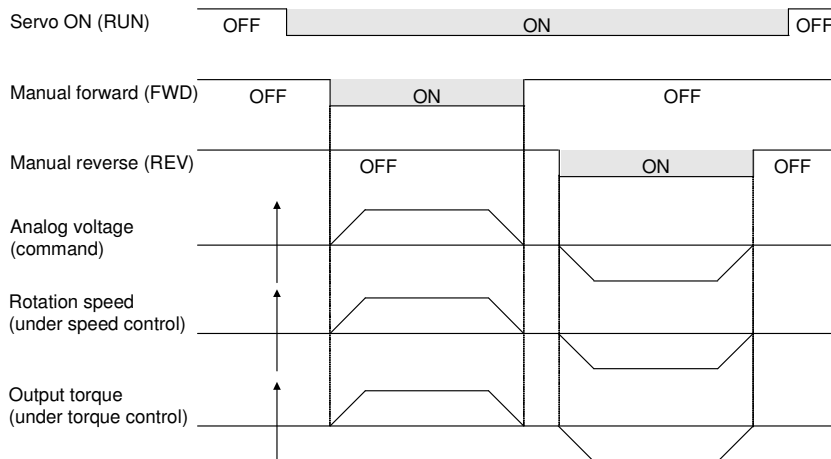

- (5) Turn ON the operation command (RUN) and make the system ready for rotation. Then output an analog command from the upper level control system to operate the motor. * At this time, check the rotation direction.

* During torque control, the motor rotation speed is not controlled. If test operation is performed without a load, the rotation speed increases up to the maximum rotation speed.

Make sure to set the maximum rotation speed of parameter #34 to a low value, which is safe as the maximum rotation speed. (Example: 50 [r/min])

① Check rotation speed
 Check the touch panel monitor.

② Calculation method for motor rotation speed from analog command voltage (speed control)

$$\text{Rotation speed [r/min]}^* = \frac{\text{Maximum rotation speed [r/min]}}{10 \text{ [V]}} \times \text{Parameter \#70} \times \text{Analog command voltage [V]}$$

* The rotation speed does not exceed the maximum rotation speed.

③ Calculation method of torque command from analog command voltage (speed control)

$$\text{Torque command [\%]}^* = \frac{\text{Maximum torque [\%]}}{9 \text{ [V]}} \times \text{Parameter \#70} \times \text{Analog command voltage [V]}$$

* The torque command does not exceed the maximum torque.

④ Check rotation direction

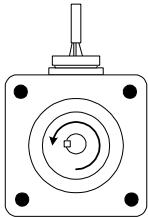

Forward direction (CCW)

- (6) When the items above are checked, turn OFF the operation command (RUN) and shutoff the power supply

Now, the 2nd stage test operation in the speed/torque control mode is completed

Troubleshooting (1) Motor does not rotate.

<Check>

- Check wiring with the upper level control system.
- Check with the keypad of the servo amplifier if the servomotor is ready for rotation.
- Check that the upper level control system is correctly giving the analog voltage.
- Check with the keypad if the servo amplifier is receiving the analog voltage.

(2) The motor rotates when the analog voltage command is "0V".

<Check>

- Adjust the analog command offset (parameter #71).
- Use the zero clamp function (parameter #39).

Third Stage Mount the servo amplifier to the host controller and mount the servomotor to the machine to perform test operation. The test operation should be conducted in the final operation state.

Check the following items in the second stage.

<Check>

- (1) Installation of servomotor to mechanical system
- (2) Check I/O signals.
- (3) Check movement of the machine.

Test operation procedure (1) Referring to Chapter 2 “Servomotor,” mount the servomotor to the machine securely. (Mount securely without play or deflection.)

(2) Check I/O signals checked in "2nd stage."

In particular, check forced stop (EMG), \pm overtravel (\pm OT) and brake timing which are protective functions. Check that the servo amplifier is recognizing each signal and is performing protective functions.

- (3) Check that the command movement matches the actual movement of the machine.
- (4) According to description in Chapter 6 “Adjustment of servo,” adjust the parameters of the servo amplifier.

If no fault is found in the third stage, the test operation is complete.

Brake timing output

- Notes**
- (1) Brake is only used for "retention." Do not use it for braking.
 - (2) Do not use the 24V power supply for the sequence input/output signal.
Prepare the brake power source separately.
 - (3) When the brake is turned ON/OFF using the brake timing output, make sure to turn OFF the servo ON (RUN) signal and shut off the power supply.

Timing chart (1) ON/OFF of servo ON (RUN) signal

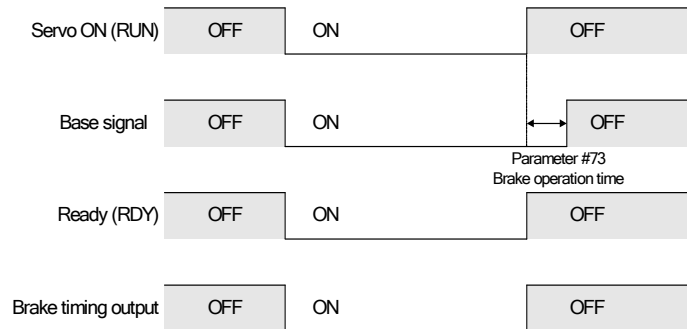

(2) ON/OFF of emergency stop (EMG) signal

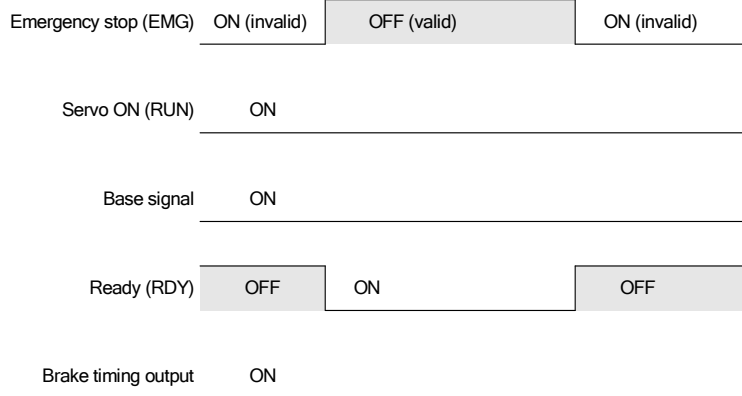

(3) Alarm occurrence

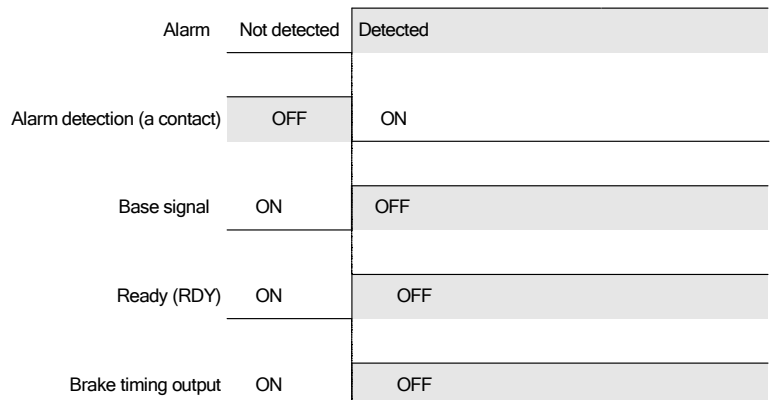

Return to origin

When a BSD series system returns to the origin, input the return-to-origin pattern from the upper level control system.

When the Z phase of the servomotor is detected to return to the origin immediately after the power supply, turn the motor 372° or more at a speed of 100 [r/min]. If this condition is not satisfied, the Z phase cannot be correctly detected.

<Notes for return to origin by detecting Z phase immediately after power supply>

- Rotation speed: 100 r/min or less
- Rotation angle: 372° or more (equivalent to approximately 1.04 rotations) at motor output shaft.

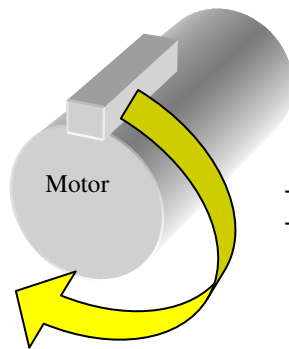

Turn the motor shaft by 372° .
The speed is 100 r/min or less.

Chapter 5 – Parameters

Parameter configuration

Various parameters are used to set up the mechanical system and adjust the characteristics and accuracy of servo.

The parameters are saved in the electrically erasable programmable read-only memory (EEPROM) and are not lost even when the power is turned off.

Parameters marked “Power” in the “Change” field in the parameter list become valid after the power supply is turned off and on again. (Check that the keypad panel (7-segment LED display) is unlit when the power is turned off.)

Parameter editing method There are two parameter editing methods:

- (1) through keypad panel operation
- (2) through BSD Configurator operation

Parameter editing through keypad operation

Press the **MODE ESC** key to select the parameter editing mode.

Press the **▼** or **▲** key to select the desired parameter number.

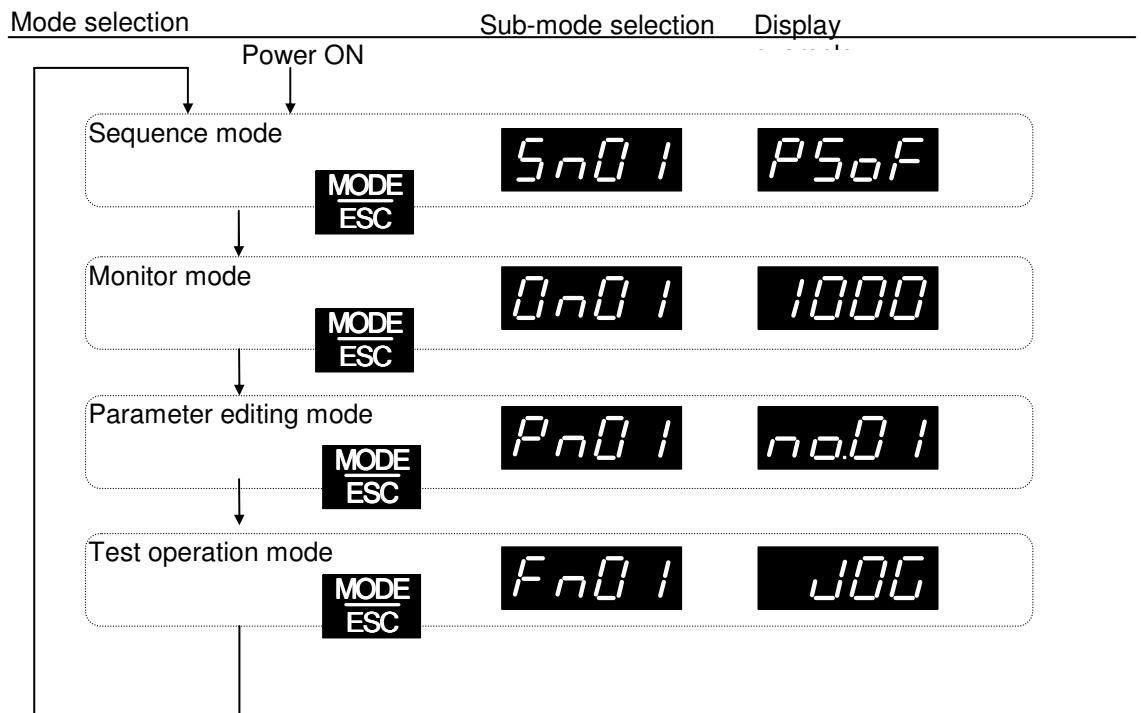

Parameter editing through BSD Configurator

Use the BSD Configurator to edit parameters.

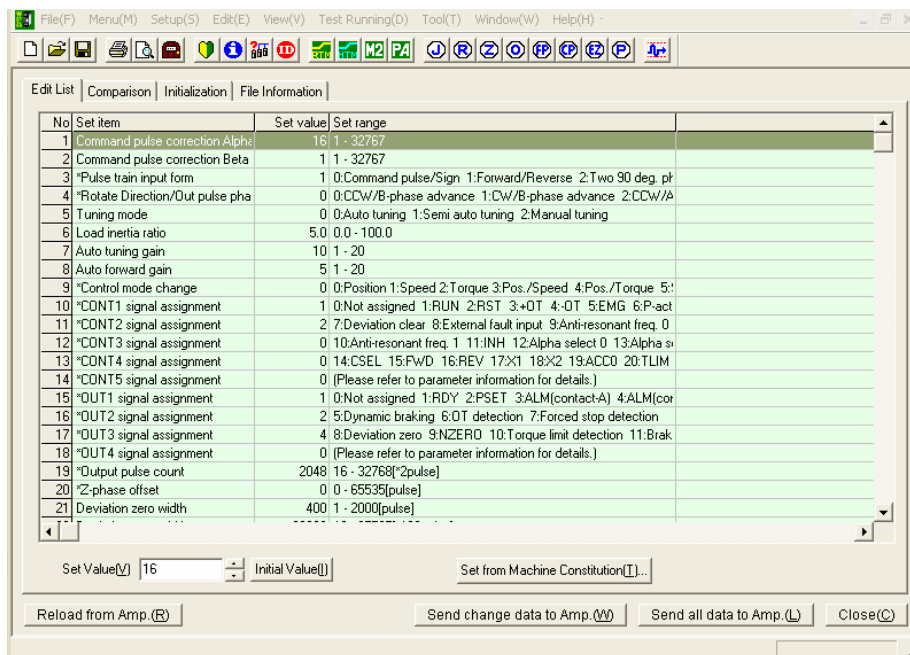

List of parameters

■Parameter list (1)

No.	Name	Control mode			Reference page
		Position	Speed	Torque	
01	Command pulse compensation α	0	-	-	5-9
02	Command pulse compensation β				
03	Pulse string input type	0	-	-	5-11
04	Rotation direction switching/output pulse phase switching	0	0	0	5-13
05	Tuning mode	0	0	-	5-14
06	Load inertia ratio	0	0	-	5-15
07	Auto tuning gain	0	0	-	5-16
08	Auto forward gain	0	-	-	5-17
09	Control mode switching	0	0	0	5-18
10	CONT 1 signal allocation	0	0	0	5-20
11	CONT 2 signal allocation				
12	CONT 3 signal allocation				
13	CONT 4 signal allocation				
14	CONT 5 signal allocation				
15	OUT 1 signal allocation	0	0	0	5-42
16	OUT 2 signal allocation				
17	OUT 3 signal allocation				
18	OUT 4 signal allocation				
19	No. of output pulses	0	0	0	5-53
20	Z phase offset	0	0	0	5-54
21	Zero deviation width	0	-	-	5-55
22	Deviation limit width	0	-	-	5-56
23	Zero speed width	0	0	0	5-56
24	Positioning end judgment time	0	-	-	5-57
25	Maximum current limit value	0	0	0	5-57
26	Alarm detection for undervoltage	0	0	0	5-58
27	Operation for undervoltage	-	0	-	5-58
28	For adjustment by manufacturer	-	-	-	5-59
29	Parameter write-protection	0	0	0	5-59
30	Initial display of the keypad	0	0	0	5-60
31	Manual feed speed 1 (and test operation)	0	0	-	5-61
32	Manual feed speed 2	0	0	-	
33	Manual feed speed 3	0	0	-	
34	Maximum rotating speed	0	0	0	5-61
35	Acceleration time 1 (and test operation)	0	0	-	5-62
36	Deceleration time 1 (and test operation)	0	0	-	
37	Acceleration time 2	0	0	-	
38	Deceleration time 2	0	0	-	
39	Zero clamp level	0	0	-	5-63
40	Position controller gain 1	0	-	-	5-66
41	Speed response 1	0	0	-	
42	Speed controller integration time 1	0	0	-	
43	S-curve time constant	0	0	-	5-68
44	Feed forward gain	0	-	-	5-68
45	Feed forward filter time constant	0	-	-	5-66
46	Torque filter time constant	0	0	-	
47	Speed setting filter	0	0	-	5-69
48	Gain switching factor	0	0	-	5-70
49	Gain switching level	0	0	-	
50	Gain switching time constant	0	0	-	

■Parameter list (2)

No.	Name	Control mode			Reference page
		Position	Speed	Torque	
51	Position controller gain 2	○	-	-	5-70
52	Speed response 2	○	○	-	
53	Speed controller integration time 2	○	○	-	
54	Torque setting filter	-	-	○	5-71
55	Command follow-up control selection	○	-	-	5-71
56	Notch filter 1 frequency	○	○	-	5-72
57	Notch filter 1 damping				
58	Notch filter 2 frequency				
59	Notch filter 2 damping				
60	Anti-resonance frequency 0	○	-	-	5-73
61	Anti-resonance frequency 1				
62	Anti-resonance frequency 2				
63	Anti-resonance frequency 3				
64 to 69	Not used	-	-	-	-
70	Analog command gain	○	○	○	5-74
71	Analog command offset				
72	Motion sequence selection for dynamic brake unit connection	○	○	○	5-76
73	Brake operation time	○	○	○	5-76
74	CONT normally ON 1	○	○	○	5-77
75	CONT normally ON 2				
76	CONT normally ON 3				
77	CONT normally ON 4				
78	Command pulse compensation α 1	○	-	-	5-78
79	Command pulse compensation α 2				
80	Command pulse compensation α 3				
81	Parameter storage in RAM	○	○	○	5-78
82	Station number	○	○	○	5-79
83	Baud rate				
84	Easy tuning: Travel setting	○	○	○	5-79
85	Easy tuning: Speed setting				
86	Easy tuning: Timer setting				
87	Monitor 1 signal allocation	○	○	○	5-80
88	Monitor 2 signal allocation				
89	Monitor 1 scale				
90	Monitor 1 offset				
91	Monitor 2 scale				
92	Monitor 2 offset				
93	Not used	-	-	-	-
94	For adjustment by manufacturer	-	-	-	5-82
95	For adjustment by manufacturer				
96	For adjustment by manufacturer				
97	For adjustment by manufacturer				
98 to 99	Not used	-	-	-	-

BSD Parameter List (1)

No.	Name	Setting range	Initial value	Change
01	Command pulse compensation α	1 - 32767 (increments of 1)	16	Always
02	Command pulse compensation β	1 - 32767 (increments of 1)	1	Always
03	Pulse string input type	0: Command pulse/command symbol 1: Forward/reverse rotation pulse 2: 90 degree phase difference 2 signal	1	Power
04	Rotation direction switching/output pulse phase switching	0: Positive direction forward rotation (CCW)/B phase advance 1: Positive direction reverse rotation (CW)/B phase advance 2: Positive direction forward rotation (CCW)/A phase advance 3: Positive direction reverse rotation (CW)/A phase advance	0	Power
05	Tuning mode	0: Auto tuning 1: Semi-auto tuning 2: Manual tuning	0	Always
06	Load inertia ratio	GYS type: 0.0 - 100.0 times (increments of 0.1) GYG type: 0.0 - 30.0 times (increments of 0.1)	5.0 (1.0)	Always
07	Auto tuning gain	1 - 20 (increments of 1)	10	Always
08	Auto forward gain	1 - 20 (increments of 1)	5	Always
09	Control mode switching	0: Position 1: Speed 2: Torque 3: Position \leftrightarrow Speed 4: Position \leftrightarrow Torque 5: Speed \leftrightarrow Torque	0	Power
10	CONT 1 signal allocation	0 - 21 (increments of 1) 0: Not specified 1: Servo ON [RUN] 2: Reset [RST] 3: +OT 4: -OT 5: Emergency stop [EMG] 6: P motion 7: Deviation clear 8: External regenerative resistor 9: Anti-resonance frequency overheating selection 0 10: Anti-resonance frequency 11: Command pulse inhibition selection 1 selection 1 12: Command pulse α selection 0 15: Manual forward rotation [FWD] 16: Manual reverse rotation [REV] 17: Multistep speed 1 [x1] 18: Multistep speed 2 [x2] 19: Acceleration/deceleration time selection 20: Current limiting regulator ON 21: Coasting [BX]	1[RUN]	Power
11	CONT 2 signal allocation		2[RST]	Power
12	CONT 3 signal allocation		0	Power
13	CONT 4 signal allocation		0	Power
14	CONT 5 signal allocation		0	Power
15	OUT 1 signal allocation	0 - 10 (increments of 1) 0: Not specified 1: Ready [RDY] 2: Positioning end [PSET] 3: Alarm detection: a contact 4: Alarm detection: b contact 5: Dynamic braking 6: OT detection 7: Forced stop detection 8: Zero deviation 9: Zero speed 10: Current limit detection 11: Brake timing	1[RDY]	Power
16	OUT 2 signal allocation		2[PSET]	Power
17	OUT 3 signal allocation		4[ALMb]	Power
18	OUT 4 signal allocation		0	Power
19	No. of output pulses	16 - 32768 [pulse] (increments of 1)	2048	Power
20	Z phase offset	0 - 65535 [x2 pulse] (increments of 1)	0	Power
21	Zero deviation width	1 - 2000 [pulse] (increments of 1)	400	Always
22	Deviation limit width	10 - 65535 [x100 pulse] (increments of 1)	20000	Always
23	Zero speed width	10 - Maximum rotation speed [r/min] (increments of 1)	50	Always
24	Positioning end judgment time	0.000 - 1.000 sec (increments of 0.001)	0.000	Always
25	Maximum current limit value	0 - 300% (increments of 1)	300	Always
26	Alarm detection for undervoltage	0: Not detected, 1: Detected	1	Power
27	Operation for undervoltage	0: Sudden deceleration and stop, 1: Coasting	0	Power
28	For adjustment by manufacturer	-	-	-
29	Parameter write-protection	0: Rewritable, 1: Write protected	0	Always
30	Initial display of the keypad	0 - 20 (increments of 1)	0	Power

Values in () are the initial values of the BSM motor.

BSD Parameter List (2)

No.	Name	Setting range	Initial value	Change
31	Manual feed speed 1 (and test operation)	0.1 - Maximum rotation speed [r/min] (increments of 0.1)	100.0	Always
32	Manual feed speed 2	0.1 - Maximum rotation speed [r/min] (increments of 0.1)	500.0	Always
33	Manual feed speed 3	0.1 - Maximum rotation speed [r/min] (increments of 0.1)	1000.0	Always
34	Maximum rotation speed	0.1 - Maximum rotation speed [r/min] (increments of 0.1)	5000.0 (3000.0)	Always
35	Acceleration time 1 (and test operation)	0.000 - 9.999 sec. (increments of 0.001)	0.100	Always
36	Deceleration time 1 (and test operation)	0.000 - 9.999 sec. (increments of 0.001)	0.100	Always
37	Acceleration time 2	0.000 - 9.999 sec. (increments of 0.001)	0.500	Always
38	Deceleration time 2	0.000 - 9.999 sec. (increments of 0.001)	0.500	Always
39	Zero clamp level	0.0 - 500.0[r/min] (increments of 0.1)	0.0	Always
40	Position controller gain 1	1 - 1000[rad/sec] (increments of 1)	*1	Always
41	Speed response 1	1 - 1000[Hz] (increments of 1)	*1	Always
42	Speed controller integration time 1	1.0 - 1000.0[msec] (increments of 0.1)	*1	Always
43	S-curve time constant	0.0 - 100.0[msec] (increments of 0.1)	2.0	Always
44	Feed forward gain	0.000 - 1.500 (increments of 0.001)	0.000	Always
45	Feed forward filter time constant	0.0 - 250.0[msec] (increments of 0.1)	*1	Always
46	Torque filter time constant	0.00 - 20.00[msec] (increments of 0.01)	*1	Always
47	Speed setting filter	0.00 - 20.00[msec] (increments of 0.01)	0.00	Always
48	Gain switching factor	0: Position deviation ($\times 10$), 1: Feedback speed, 2: Command speed	1	Always
49	Gain switching level	1 - 1000 (increments of 1)	50	Always
50	Gain switching time constant	0 - 100[msec] (increments of 1)	10	Always
51	Position controller gain 2	30 - 200% (increments of 1)	100	Always
52	Speed response 2	30 - 200% (increments of 1)	100	Always
53	Speed controller integration time 2	30 - 200% (increments of 1)	100	Always
54	Torque setting filter	0.000 - 9.999[sec] (increments of 0.001)	0.000	Always
55	Command follow-up control selection	0: None, 1: Command follow-up control, 2: Command follow-up control (compensated for while stopped)	0	Power
56	Notch filter 1 frequency	10 - 200[$\times 10$ Hz] (increments of 1)	200	Always
57	Notch filter 1 damping	0 - 40[dB] (increments of 1)	0	Always
58	Notch filter 2 frequency	10 - 200[$\times 10$ Hz] (increments of 1)	200	Always
59	Notch filter 2 damping	0 - 40[dB] (increments of 1)	0	Always
60	Anti-resonance frequency 0	5.0 - 200.0[Hz] (increments of 0.1)	200.0	Always
61	Anti-resonance frequency 1	5.0 - 200.0[Hz] (increments of 0.1)	200.0	Always
62	Anti-resonance frequency 2	5.0 - 200.0[Hz] (increments of 0.1)	200.0	Always
63	Anti-resonance frequency 3	5.0 - 200.0[Hz] (increments of 0.1)	200.0	Always

* Values in () are the initial values of the BSM (1.0-2.0 KW) motor.

*1. Indicates the value immediately after parameter initialization is executed. The value is automatically updated if “auto tuning” or “semi-auto tuning” is selected with parameter #5.

No.	Name	Setting range	Initial value	Change
64 to 69	Not used	-	0	-
70	Analog command gain	±0.10 - ±1.50 (increments of 0.01)	1.00	Always
71	Analog command offset	-2000 - +2000	(Set before shipment)	Always
72	Operation sequence selection for dynamic brake unit connection	0: DB invalid for OT detection/RUN = DB invalid for OFF 1: DB valid for OT detection/RUN = DB invalid for OFF 2: DB invalid for OT detection/RUN = DB valid for OFF 3: DB valid for OT detection/RUN = DB valid for OFF	0	Power
73	Brake operation time	0.00 - 9.99 [sec] (increments of 0.01) Base shutoff delay time at RUN = OFF	0.00	Always
74	CONT normally valid 1	0 - 21	0	Power
75	CONT normally valid 2		0	Power
76	CONT normally valid 3		0	Power
77	CONT normally valid 4		0	Power
78	Command pulse compensation α1	1 - 32767 (increments of 1)	1	Always
79	Command pulse compensation α2		1	Always
80	Command pulse compensation α3		1	Always
81	Parameter storage in RAM	0: Not specified, 1 - 99 (increments of 1)	0	Power
82	Station number	1 - 31	1	Power
83	Baud rate	0: 38400 [bps], 1: 19200 [bps], 2: 9600 [bps]	0	Power
84	Easy tuning: Travel setting	0.5 - 200.0 [rev] (increments of 0.1)	2.0	Always
85	Easy tuning: Speed setting	10.0 - Maximum rotation speed [r/min] (increments of 0.1)	500.0	Always
86	Easy tuning: Timer setting	0.01 - 5.00[sec] (increments of 0.01)	0.50	Always
87	Monitor 1 signal allocation	1: Speed command, 2: Speed feedback, 3: Torque command, 4: Position deviation, 5: Position deviation (extension), 6: Pulse frequency	2	Always
88	Monitor 2 signal allocation		3	Always
89	Monitor 1 scale	±2.0 - ±100.0[V] (increments of 0.1)	7.0	Always
90	Monitor 1 offset	-50 - +50 (increments of 1)	0	Always
91	Monitor 2 scale	±2.0 - ±100.0[V] (increments of 0.1)	6.0	Always
92	Monitor 2 offset	-50 - +50 (increments of 1)	0	Always
93	Not used	-	0	-
94	For adjustment by manufacturer	-	Adjustment value	-
95	For adjustment by manufacturer	-	Adjustment value	-
96	For adjustment by manufacturer	-	Adjustment value	-
97	For adjustment by manufacturer	-	Adjustment value	-
98 to 99	Not used	-	0	-

Explanation of parameter

The parameters are described in the order of the parameter number.

Parameter #01 and #02



Parameter #01 and #02

No.	Name	Setting range	Initial value	Change
01	Command pulse correction α	1 to 32767 (in 1 increments)	16	Always
02	Command pulse correction β	1 to 32767 (in 1 increments)	1	Always

* It is only valid for position control.

These parameters are used to convert the travel distance per each command pulse into a unit quantity that is used by the electronic gear.

Calculate in the following equation.

Calculation formula for command pulse correction α and β

$$\frac{\text{(Mechanical system travel distance per revolution of servomotor)}}{\text{(131072 pulses/rotation)}} \times \frac{\text{(Command pulse correction } \alpha \text{)}}{\text{(Command pulse correction } \beta \text{)}} = \text{(Unit quantity)*}$$

* "Unit quantity" is a value such as "1," "0.1," "0.01," and "0.001."

$$\frac{\text{(Command pulse correction } \alpha \text{)}}{\text{(Command pulse correction } \beta \text{)}} = \frac{\text{(131072 pulses/rotation)}}{\text{(Mechanical system travel distance per revolution of servomotor)}} \times \text{(Unit quantity)}$$

Reduce the fraction so that command pulse correction α and β become integers within 32767

Setting from BSD Configurator

Use the “ α and β setting from mechanical configuration” button in the parameter editing screen of the BSD Configurator to automatically specify command pulse correction values α and β

< α / β setting screen >

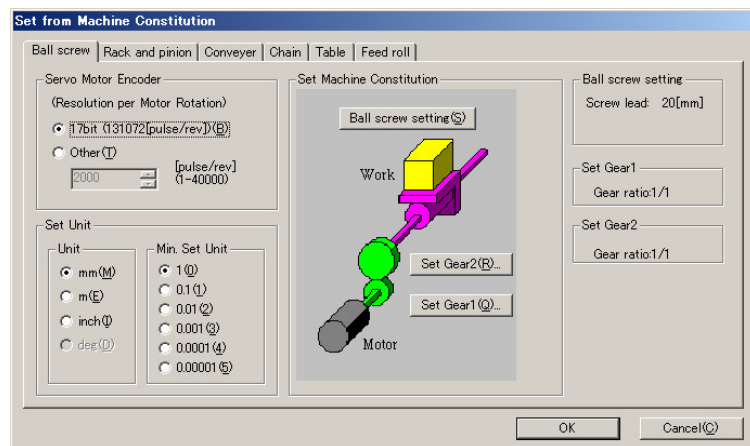

Data are automatically set by simply entering the machine specifications.

Because settings are given for each component of the machine, entry is simply

To couple 10-mm-lead screw to the output shaft of the servomotor with a setting unit of 1/100

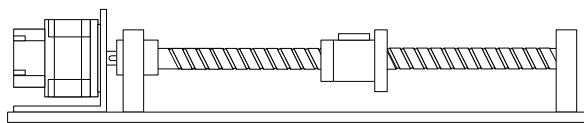

$$\frac{\text{(Mechanical system travel distance per revolution of servomotor)}}{(131072 \text{ pulses/rotation})} \times \frac{\text{(Command pulse correction } \alpha \text{)}}{\text{(Command pulse correction } \beta \text{)}} = \text{(Unit quantity)}$$

$$\frac{10 \text{ mm}}{(131072 \text{ pulses/rotation})} \times \frac{\text{(Command pulse correction } \alpha \text{)}}{\text{(Command pulse correction } \beta \text{)}} = 1/100$$

Hence command pulse correction α becomes “16384” and command pulse correction β becomes “125.”

With the above settings, the mechanical system travel distance per each pulse in the pulse string becomes 0.01 mm.

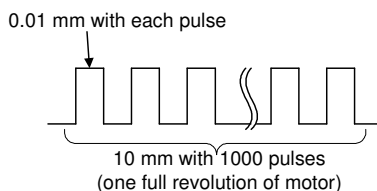

Hint The pi (π) included in the mechanical system travel distance per each revolution of the servomotor can be approximated with “355 / 113.”

The number of output pulses has nothing to do with command pulse correction. According to the setting of parameter #19, two signals with phase-B-advanced 90-degree phase difference are output when the motor shaft rotates in the forward direction.

Parameter #03



Parameter #03

No.	Name	Setting range	Initial value	Change
03	Pulse string input form	0: Command pulse / command sign, 1: Forward / reverse rotation pulse, 2: Two signals with 90-degree phase difference	1	Power

* It is only valid for position control.

The form of the signal added to the pulse string input terminal can be selected.

The form of pulse strings added to the [CA], [*CA], [CB] and [*CB] pulse string input terminals of the servo amplifier can be specified. The maximum input frequency is 1.0MHz.

Command pulse/command sign
(Setting of parameter 03: 0)

The rotation amount is indicated with the command pulse while the direction of rotation is indicated with the command sign

- Differential input

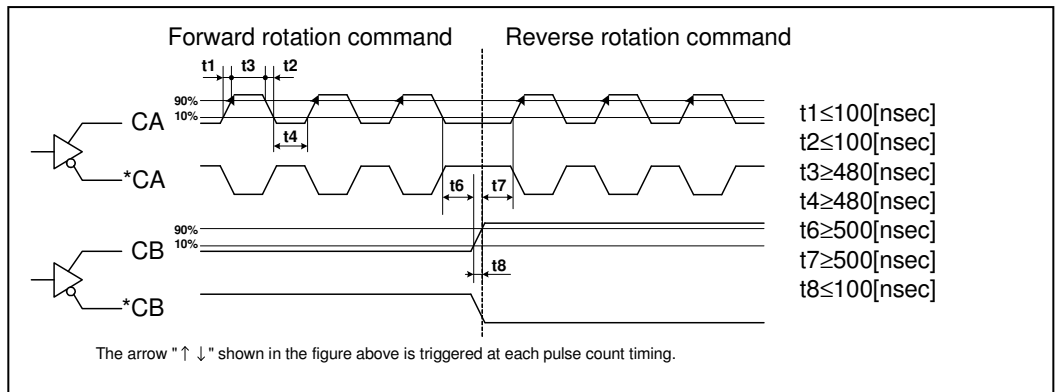

- Open collector input

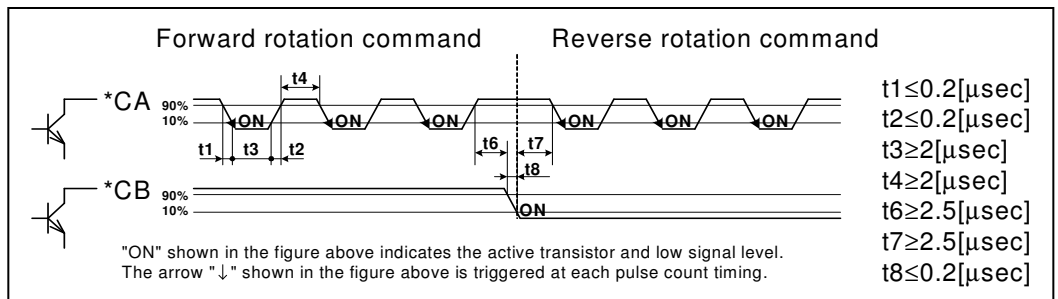

Forward / reverse rotation pulse (Setting of parameter 03: 1)

The forward rotation pulse indicates the rotation amount in the positive direction, while the reverse pulse indicates that in the reverse direction

- Differential input

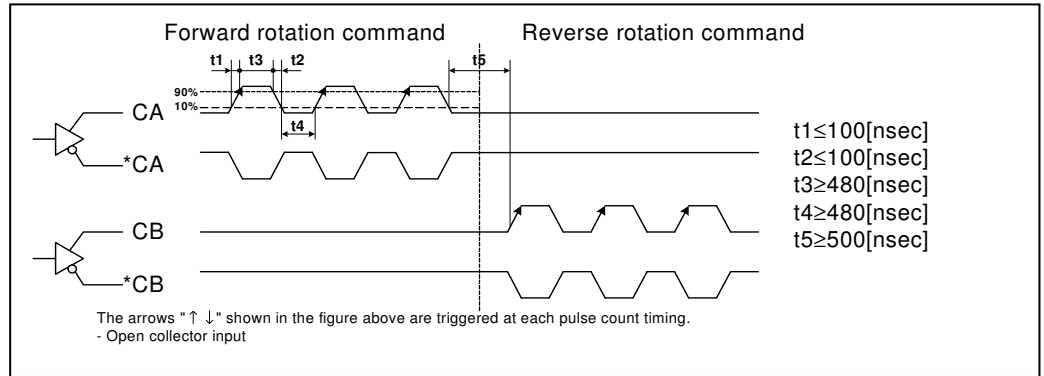

- Open collector input

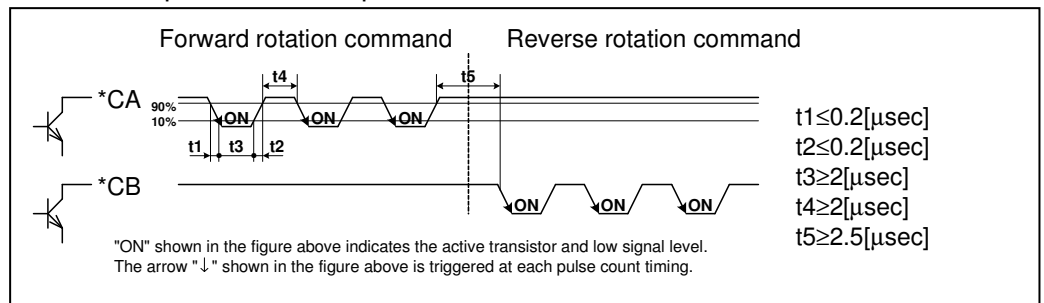

Two signals with 90-degree phase difference (Setting of parameter 03: 2)

The phase-A and phase-B signals indicate the direction of rotation and rotation amount, respectively. Each edge in the phase-A or phase-B signal corresponds to one pulse.

- Differential input

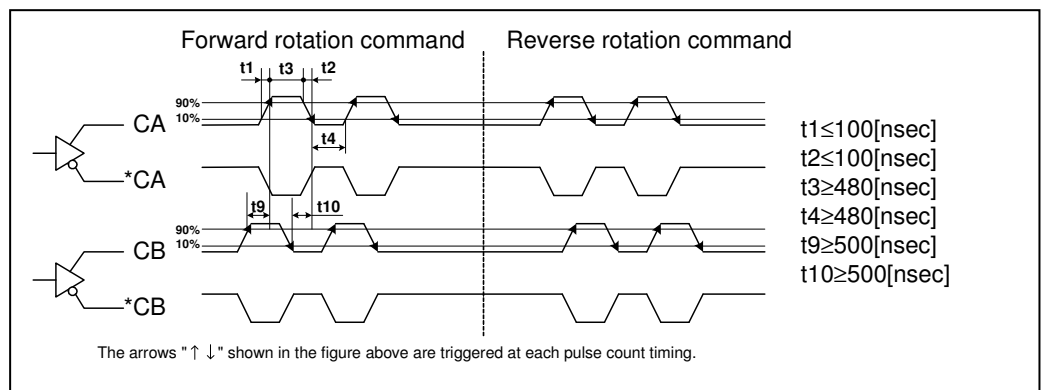

- Open collector input

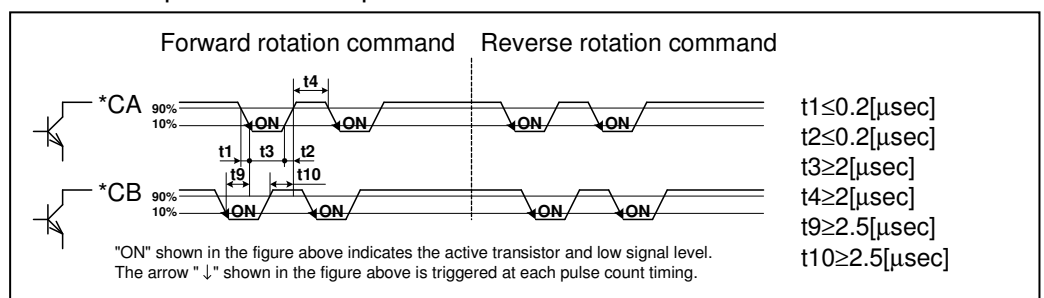

Parameter #04



Parameter #04

No.	Name	Setting range	Initial value	Change
04	Rotation direction switching/output pulse switching for rotation in CCW direction	0: Positive direction forward rotation (CCW)/B phase advance 1: Positive direction reverse rotation (CW)/B phase advance 2: Positive direction forward rotation (CCW)/A phase advance 3: Positive direction reverse rotation (CW)/A phase advance	0	Power

Set the servomotor rotation direction and the output pulse phase to the direction the machine is moving.

The rotation direction when the forward rotation pulse and the command signal are the H level or the 90 degree phase difference 2 signal with input of B phase advance pulse string is the positive direction.

To switch the output pulse phase, select the phase when the servomotor is rotating counterclockwise (CCW).

- When the reference value is 0 or 1

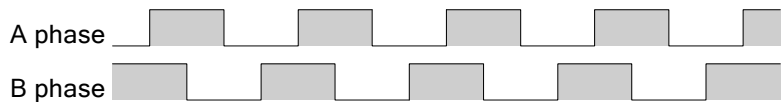

- When the reference value is 2 or 3

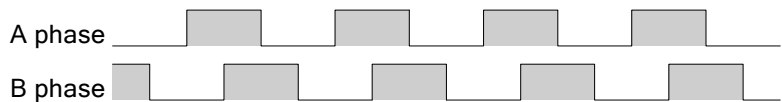

Forward/reverse rotation

Counterclockwise rotation (CCW) when the servomotor output shaft is viewed from the front is forward rotation. Clockwise rotation (CW) is reverse rotation.

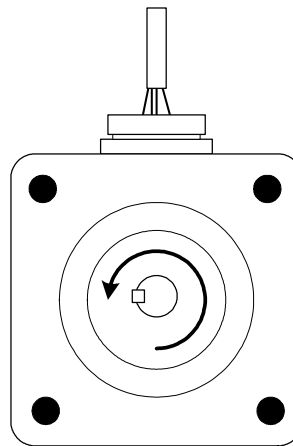

Forward rotation

Parameter #05



Parameter #05

No.	Name	Setting range	Initial value	Change
05	Tuning mode	0: Auto tuning, 1: Semi-auto tuning, 2: Manual tuning	0	Always

It is valid for position control and speed control.

Select the tuning method of the servo amplifier.

Auto tuning (Setting of basic setting parameter 05: 0)

This is the factory setting of the servo amplifier.

The inertia ratio of the machine is always assumed inside the amplifier in this mode to automatically set the optimum gain.

Set 0 for Smart Tuning.

Semi-auto tuning (Setting of parameter 05: 1)

Use this mode when the inertia ratio of the machine cannot be assumed correctly inside the amplifier

Manual tuning (Setting of parameter 05: 2)

Use this option when adjustment fails in the auto tuning and semi-auto tuning modes

Parameters that must be set or those automatically adjusted in each tuning mode are as follows.

No.	Name	Tuning mode		
		0: Auto	1: Semi-auto	2: Manual
06	Load inertia ratio	-	○	○
07	Auto tuning gain	○	○	×
40	Position controller gain 1	-	-	○
41	Speed response 1	-	-	○
42	Speed controller integration time 1	-	-	○
45	Feed forward filter time constant	-	-	○
46	Torque filter time constant	-	-	○

- * ○ : Parameter that must be set
- : Parameter that may not be set (The value is automatically calculated inside the amplifier and the result is reflected on the parameter.)
- × : The parameter has no effect even if it is set.

Refer to Chapter 6 for detailed description of tuning.

Parameter #06



Parameter #06

No.	Name	Setting range	Initial value	Change
06	Load inertia ratio	GYS motor: 0.0 - 100.0 times (in 0.1 increments) GYG motor: 0.0 - 30.0 times (in 0.1 increments)	5.0 (1.0)	Always

* It is valid for position control and speed control.

Values in () are the initial values of the BSM (1.0-2.0 KW) motor.

Specify the moment of inertia of the load (moment of inertia of load converted to motor shaft) exerted on the motor shaft in the mechanical system, in the ratio to the moment of inertia of the motor.

$$\text{Load inertia ratio} = \frac{\text{(Moment of inertia of load converted to motor shaft)}}{\text{(Moment of inertia of motor)}}$$

This parameter must be specified in some tuning modes (basic parameter 05).

No.	Name	Tuning mode		
		0: Auto	1: Semi-auto	2: Manual
06	Load inertia ratio	Automatically refreshed at every 10 minutes	0	0

O:Parameter that must be set

How to specify the load inertia ratio

There are the following two setting methods.

1) Setting the value monitored at the keypad panel

Use monitor mode **0r 12** at the keypad panel to monitor.

Use the monitored value as a setting.

* If the value fluctuates, set the average value.

If fluctuation is considerable and the maximum-to-minimum ratio exceeds two, use the setting method described below.

2) Setting the calculated value

Calculate the load inertial moment and specify the result.

The calculation formula for obtaining the moment of inertia is described in appendix.

* Capacity selection software can be used for automatic calculation.

The capacity selection software can be downloaded free of charge from ABB Sace Electric's home page.

<http://www.ABB Saceelectric.co.jp/fcs/eng/>

Parameter #07



Parameter #07

No.	Name	Setting range	Initial value	Change
07	Auto tuning gain	1 to 20 (in 1 increments)	10	Always

* It is valid for position control and speed control.

Specify the response of the servomotor used in the auto tuning or semi-auto tuning mode.

Specify a larger value to reduce the command follow-up time and positioning setting time, but too large a value cause the motor to vibrate.

* There is no need to set the parameter in the manual tuning mode.

Setting method There are two setting methods

- 1) Setting parameter using BSD Configurator and keypad panel (parameter setting mode)

After the parameter is established, the setting content is updated.

- 2) Setting through auto tuning gain setting from keypad panel (in test operation mode)

The setting is updated at real time when the value is changed.

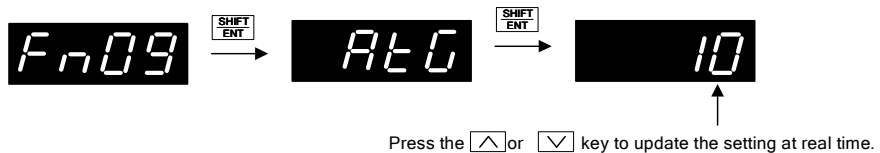

Approximate measure for setting

* If the gain cannot be increased up to the value specified as an approximate measure, there may be mechanical resonance. Use a notch filter to suppress mechanical resonance.

→ See page 5-72 (notch filter setting method) and page 6-12 (auto tuning).

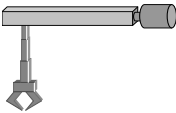
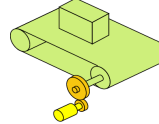
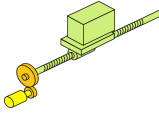
Configuration of machine	Auto tuning gain (approximate)
Large transfer machine	1 to 6
 Arm robot	5 to 10
 Belt drive	7 to 13
 Ball screw mechanism	10 to 15
Inserting, mounting or bonding machine	13 to 20

Parameter #08



Parameter #08

No.	Name	Setting range	Initial value	Change
08	Auto forward gain	1 - 20 (in 1 increments)	5	Always

It is only valid for position control.

This reduces the positioning setting time for auto/semi-auto tuning.

The larger this value is, the shorter the positioning setting time is. It is effective to reduce the tact time.

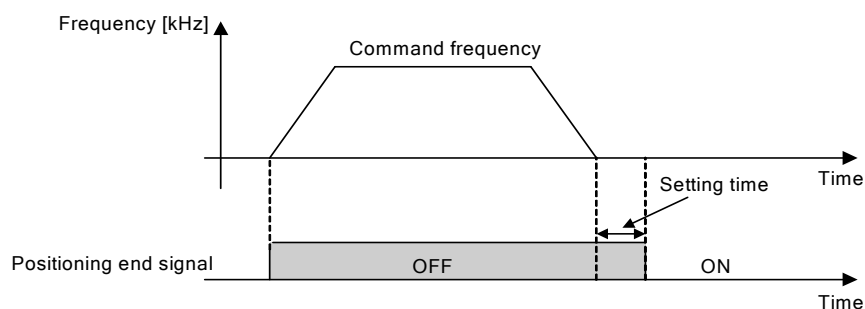

With adjustment of the auto forward gain, the following parameters are automatically adjusted.

No.	Name	Setting range	Initial value	Change
45	Feed forward filter time constant	0.0 - 250.0 [msec] (in 0.1 increments)	Initial value	Always

* Precautions for adjustment of auto forward gain

- 1) Make adjustment after adjustment of the auto tuning gain (standard parameter # 7).
- 2) Minimize the command pulse compensation (guideline value below).

$$\frac{\text{Command pulse compensation } \alpha \text{ (parameter \# 1)}}{\text{Command pulse compensation } \beta \text{ (parameter \# 2)}} \leq 30$$

<When the parameters below are set, the auto forward gain is invalid.>

- The tuning (parameter # 5) reference value is "2 (manual)".
- The command following control selection (parameter # 55) reference value is "1" or "2".

Parameter #55

No.	Name	Setting range	Initial value	Change
55	Command following control selection	0: None, 1: Command following control, 2: Command following control (compensated during stop)	0	Power

Parameter #09



Parameter #09				
No.	Name	Setting range	Initial value	Change
09	Control mode switching	0: Position, 1: Speed 2: Torque, 3: Position⇔Speed 4: Position⇔Torque, 5: Speed⇔Torque	0	Power

The BSM control function is of 3 types.

- Position control

Rotation of the servomotor output shaft is controlled (pulse string input).

- Speed control

The rotation speed of the servomotor output shaft is controlled.

- Torque control

Torque of the servomotor output shaft is controlled.

Switching method to each control mode

With parameter 09, whether the control mode is fixed or the control mode is switched by CONT signal allocation control mode switching (14) can be selected.

Position⇔Speed, Position⇔Torque and Speed⇔Torque can be switched at any time.

Basic setting parameter 09

Parameter reference value	Control mode	
	Control mode switching = OFF	Control mode switching = ON
0	Position control (fixed)	
1	Speed control (fixed)	
2	Torque control (fixed)	
3	Position control	Speed control
4	Position control	Torque control
5	Speed control	Torque control

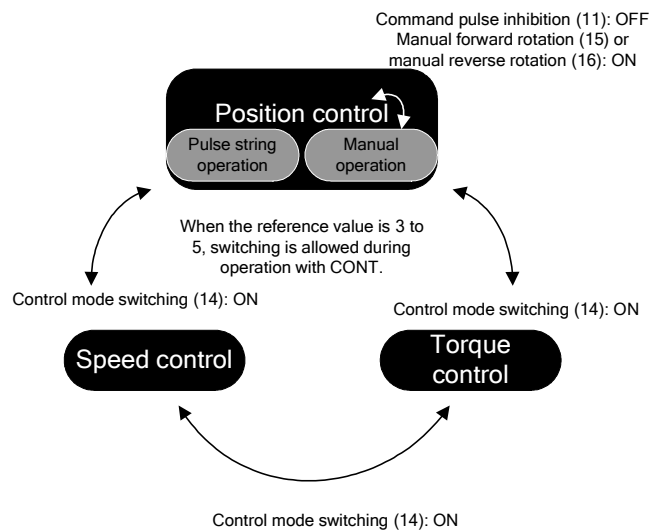

Transition time to each control mode

The transition time to each control mode is 5 [ms].

Enter the switch signal and enter the following command 5 [ms] later.

Ex.) Position control → Switching to speed control

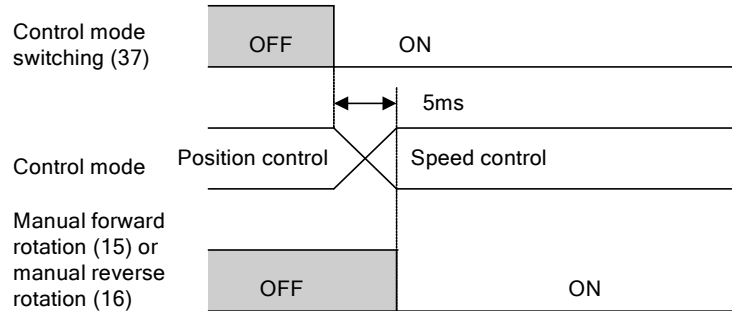

Position control It is applicable to the pulse string operation, multistep speed operation (3rd speed) and analog speed command input operation. When command pulse inhibition (27) is ON, it is inhibited.

Speed control It is applicable to the multistep speed operation (3rd speed) and analog speed command input operation.

Torque control It is applicable to the analog torque command input operation.

Parameter #10-#14 Parameters are described in the order of the parameter number.



Parameters #10 through #14

No.	Name	Setting range	Initial value	Change
10	CONT 1 signal allocation	0 to 21 (in 1 increments) 0: Not specified 1: Servo ON (RUN) 2: Reset [RST] 3: + overtravel 4: - overtravel 5: Emergency stop [EMG] 6: P-action 7: Deviation clearance 8: External regenerative resistor overheat 9: Anti-resonance frequency selection 10: Anti-resonance frequency selection 1 11: Command pulse inhibition 12: Command pulse α selection 0 13: Command pulse α selection 1 14: Control mode switching 15: Manual forward rotation [FWD] 16: Manual reverse rotation [REV] 17: Multistep speed 1 [x1] 18: Multistep speed 2 [x2] 19: Acceleration/deceleration time selection 20: Current limiting regulator ON 21: Coasting [BX]	1 [RUN]	Power
11	CONT 2 signal allocation		2 [RST]	Power
12	CONT 3 signal allocation		0	Power
13	CONT 4 signal allocation		0	Power
14	CONT 5 signal allocation		0	Power

Parameter #15 - #18



Parameters #15 and #18

No.	Name	Setting range	Initial value	Change
15	OUT 1 signal allocation	0 to 11 (in 1 increments) 0: Not specified 1: Ready [RDY] 2: Positioning end [PSET] 3: Alarm detection: a-contact 4: Alarm detection: b-contact 5: Dynamic brake 6: Overtravel detection 7: Forced stop detection 8: Zero deviation 9: Zero speed 10: Current limit detection 11: Brake timing	1 [RDY]	Power
16	OUT 2 signal allocation		2 [PSET]	Power
17	OUT 3 signal allocation		4 [ALMb]	Power
18	OUT 4 signal allocation		0	Power

The following functions can be assigned to sequence input/output terminals

■CONT signal allocation number

Setting	Name	Page
0	Not specified	-
1	Servo ON [RUN]	5-22
2	Reset [RST]	5-23
3	+ overtravel [+OT]	5-24
4	- overtravel [-OT]	
5	Forced stop [EMG]	5-26
6	P-action	5-28
7	Deviation clearance	5-29
8	External regenerative resistor overheat	5-30
9	Anti-resonance frequency selection 0	5-31
10	Anti-resonance frequency selection 1	
11	Command pulse inhibition	5-32
12	Command pulse α selection 0	5-34
13	Command pulse α selection 1	
14	Control mode switching	5-35
15	Manual forward rotation [FWD]	5-36
16	Manual reverse rotation [REV]	
17	Multistep speed 1 [x1]	5-38
18	Multistep speed 2 [x2]	
19	Acceleration/deceleration time selection	5-39
20	Current limiting regulator ON	5-40
21	Coasting [BX]	5-41

■OUT signal allocation number

Setting	Name	Page
0	Not specified	-
1	Ready	5-42
2	Positioning end	5-43
3	Alarm detection: a-contact	5-46
4	Alarm detection: b-contact	
5	Dynamic brake	5-47
6	Overtravel detection	5-24
7	Forced stop detection	5-26
8	Zero deviation	5-48
9	Zero speed	5-49
10	Current limit detection	5-40
11	Brake timing	5-50

Each sequence input/output signal can be monitored in the trace screen of the BSD Configurator.

Terminal allocation of connector 1 (CN1) of servo amplifier and trace screen of BSD Configurator

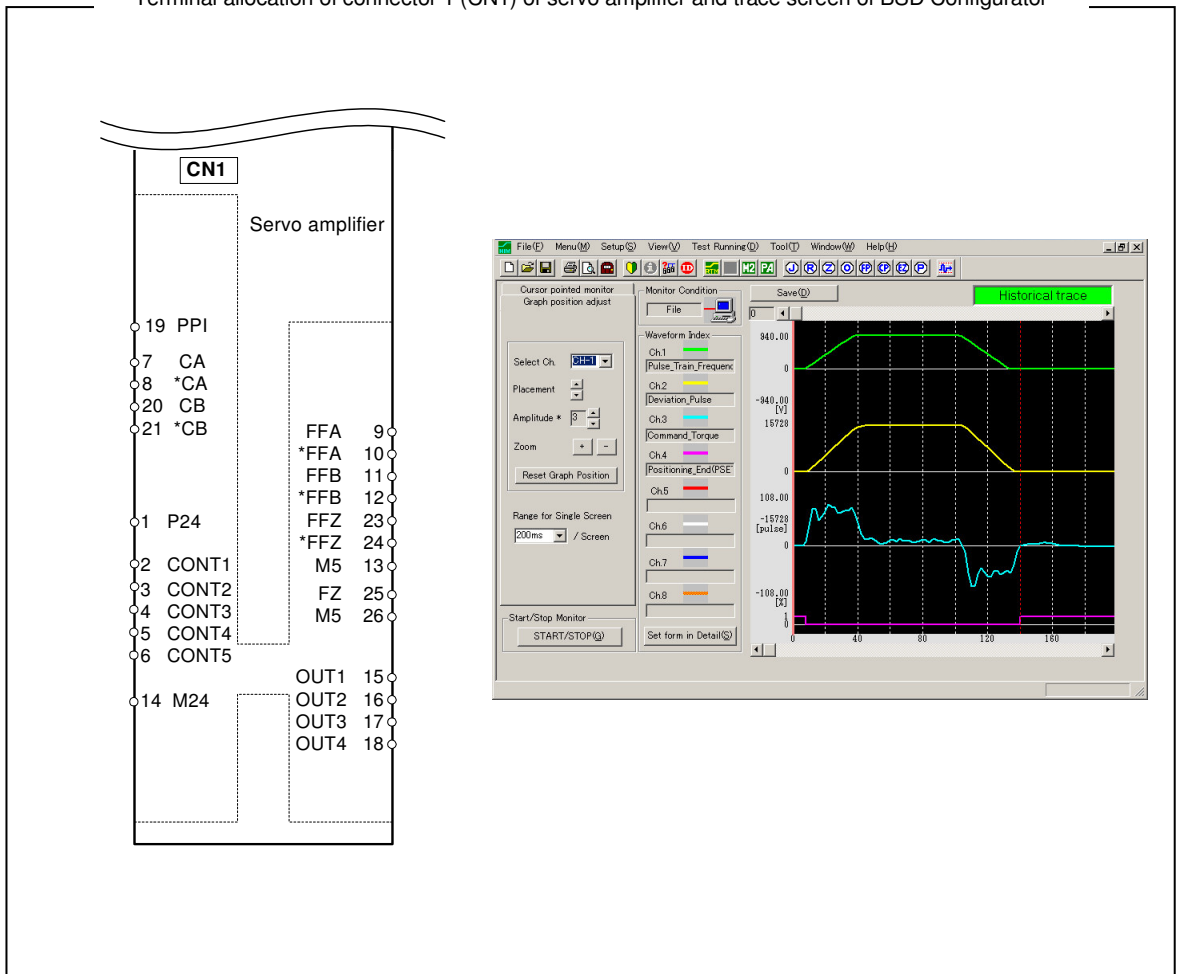

(1) Servo on [RUN] This signal makes the servomotor ready to rotate

Sequence input signal

Operation command [RUN]... Assigned to CONT 1 with factory setting

Function The servomotor is ready to rotate while the servo on [RUN] signal remains active.

The servomotor does not rotate if motor power is supplied but the servo on signal is turned off.

If the signal is turned off during rotation, the servomotor decelerates at its maximum performance and, after the stopping point (with rotation speed being within the zero speed width specified at parameter #21), the servomotor coasts to stop.

There is no retaining torque after the servomotor is stopped.

When the servo on [RUN] remains inactive, all rotation commands are ignored.

The servomotor is ready to rotate when the servo on [RUN] is active without alarm detection with active + overtravel, - overtravel and forced stop [EMG] signals.

If the servo on [RUN] signal is active and other signals are turned off, the servomotor is stopped.

Parameter setting To assign the servo on [RUN] signal to a sequence input terminal, specify the corresponding value ("1") to the system setting parameter.

If the signal is not assigned to sequence input terminals, the signal is assumed to be active at any time

Reference For the forced stop signal, refer to page 5-26

(2) Reset [RST] Alarm detection of the servo amplifier is reset

Sequence input signal	Reset [RST] ... Assigned to CONT 2 with factory setting
-----------------------	---

Function The sequence input signal resets the alarm detected at the servo amplifier. Alarm detection is reset upon the activating edge of the reset [RST] signal.

■ Alarm that can be reset by alarm reset

Indication	Description
OC1	Overcurrent 1
OC2	Overcurrent 2
OS	Overspeed
HV	Overvoltage
rH2	Regenerative transistor overheat
EC	Encoder communication alarm
OL	Overload
LV	Undervoltage
rH1	Regenerative resistance overheat
DF	Deviation limit
AH	Amplifier overheat

■ Alarm that is reset by rebooting

Indication	Description
ET	Encoder trouble
CP	Control power alarm
ME	Memory alarm
Cont	CONT duplication

Parameter setting To assign the reset [RST] signal to a sequence input terminal, specify the corresponding value (“2”) to the parameter.

If this signal is not assigned to the sequence input terminals, the signal is assumed to be inactive at any time.

Reference Alarm detection can be reset in any of the following methods.

- 1) Activating edge of reset [RST] sequence input signal
- 2) ENT key operation upon alarm reset [**Fn04**] in test operation mode
- 3) Simultaneous depression of ^ and v keys upon alarm detection [**Sn02**] (for more than 1 second)
- 4) Power off and on

The alarm history can be initialized through ENT key operation at alarm history initialization [**Fn05**] in the test operation mode.

(3) Overtravel and overtravel detection

Movement of the machine can be forcibly stopped upon a signal from a limit switch or the like

Sequence input/output signal	Overtravel / overtravel detection
------------------------------	-----------------------------------

Function +OT (3)/-OT (4)

These are input signals from limit switches for the prevention of overtravel (OT) at the end of the moving stroke of the machine.

When the input signal is turned off, the servomotor decelerates to stop at its maximum performance while ignoring the rotation command in the detected direction. Only pulse string inputs in the direction opposite to the detecting direction and manual feed (forward/reverse rotation command) in the test operation mode are executed. (b-contact)

If over-travel is detected, the position deviation is cleared.

Parameter setting To assign the +OT signal to a sequence input terminal, specify the corresponding value (“3”) to the parameter. For -OT signal, specify “4.”

These signals are assumed to be active at any time if they are not assigned to the sequence input terminals.

To assign OT detection to a sequence output terminal, specify the corresponding value (“6”) to the system setting parameter

Reference (1) Detecting direction

The +OT signal is detected while the servomotor rotates in the positive direction. The positive direction is the direction specified in basic setting parameter #4. The servomotor is not stopped even if the +OT signal is detected during rotation in the negative direction.

(2) OT detection (6)

This sequence output signal is turned on when +OT (3) or -OT (4) sequence input is turned off.

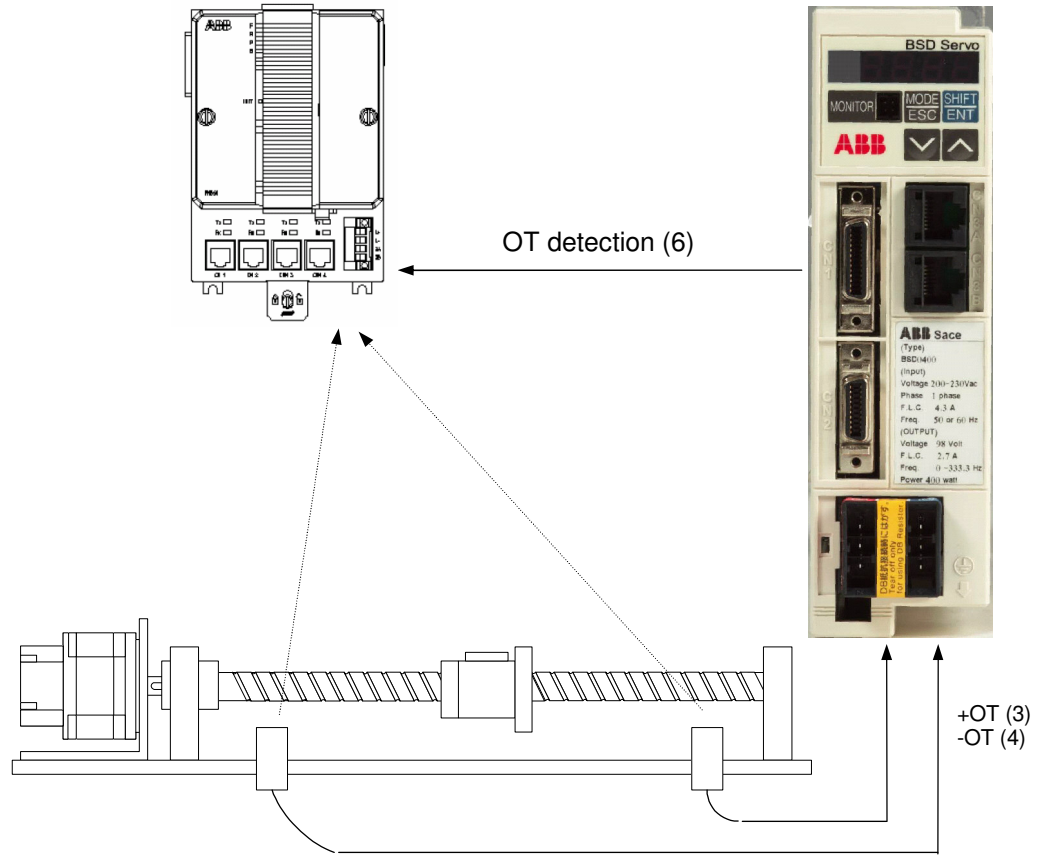

(4) Forced stop and forced stop detection

This signal supplied at the sequence input terminal stops the servomotor forcibly

Sequence input/output signal	Forced stop/forced stop detection
------------------------------	-----------------------------------

Function (1) Forced stop (Valid for position control/speed control)

The servomotor is forcibly stopped (with a b-contact) while the forced stop (5) signal is turned off.

This signal is valid in all control states and it is executed at the highest priority. Because safety and detection speeds are generally important for forced stop (5), the signal is directly connected to the servo amplifier.

Usually a self-locking pushbutton switch (command switch) on the operation panel is connected.

If forced stop is detected, the position deviation is cleared.

(2) Forced stop detection

When the forced stop (5) signal is turned off, the forced stop detection (7) signal is turned on to notify external devices of the event.

Parameter setting To assign forced stop to a sequence input terminal, specify the corresponding value ("5") to the parameter.

If this signal is not assigned to the sequence input terminals, the signal is assumed to be active at any time.

When detection of forced stop is allocated to the sequence output terminal, set value (7) applicable to the parameter.

Reference (1) Ready [RDY]

Assign the forced stop (5) signal to a sequence input terminal to turn on the ready [RDY] signal upon activation of the servo on [RUN] and forced stop signals, readying the output shaft of the servomotor to rotate

(2) State of forced stop

If forced stop (5) is inactive and servo on [RUN] is active, the servomotor is stopped with the zero speed command state.

Activate forced stop to ready the servomotor for operation.

Deactivate the servo on [RUN] signal to coast to stop.

(3) Rotation command

While the forced stop signal remains inactive, all rotation commands are ignored.

(5) P-action Proportional band control is adopted as a control method of the servo amplifier.

Sequence input signal	P-action
-----------------------	----------

Function Activate this signal while the servo on [RUN] signal is active with the motor shaft being mechanically locked.

If P-action is activated during rotation of the servomotor, position control becomes unstable. Do not activate the signal while the servomotor rotates.

Parameter setting To assign P-action to a sequence input terminal, specify the corresponding value ("6") to the parameter.
The signal is assumed to be inactive at any time if it is not assigned to the sequence input terminals

 **Hint** If the brake is handled with servo locked, an overload alarm ("OL") is detected.

This is because the servo performs PI control to generate a torque and restore the original position even upon small deviation. Therefore activate P-action without fail, using an external signal, when the brake is applied.

(6) Deviation clearance Difference (position deviation) between the command position and feedback position is reduced to zero

Sequence input signal	Deviation clearance
-----------------------	---------------------

Function While this signal remains active, the difference (position deviation) between the command position and feedback position is reduced to zero. The feedback position is made the command position.

Parameter setting To assign deviation clearance to a sequence input terminal, specify the corresponding value (“7”) to the parameter

Reference While the deviation clearance signal is activated, all rotation commands are ignored.

If the deviation clearance signal is turned on during rotation of the servomotor, pulse command, manual forward rotation [FWD] of the test operation mode and other commands are ignored, to cause the servomotor to be stopped.

Deviation accumulated at a stopper can be zeroed to avoid movement caused by the offsetting of deviation upon a released load

**(7) Regenerative resistor
overheat** Connect the thermistor signal of the external regenerative resistor (option) to this signal. When this signal is OFF with the regenerative resistor overheating alarm, the servomotor is forcibly stopped.

Sequence input signal	Regenerative resistor overheat
-----------------------	--------------------------------

Function The servomotor is forcibly stopped (with a b-contact) while the regenerative resistor overheat signal is inactive.

If this signal is deactivated during rotation, the servomotor decelerates by its maximum performance to stop (within the zero speed width (parameter #23)), and then it coasts to stop.

No holding torque generates after the servomotor is stopped.

Parameter setting To assign regenerative resistor overheat to a sequence input terminal, specify the corresponding value ("8") to the parameter.

The signal is assumed to be active at any time if it is not assigned to the sequence input terminals.

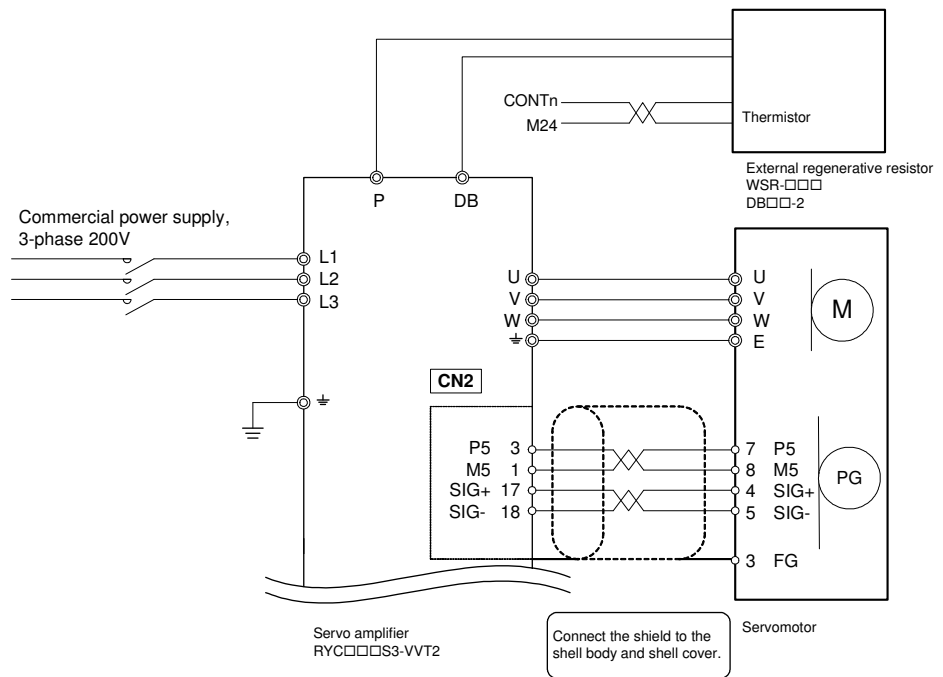

Reference

(8) Anti-resonance frequency selection 0/1

Set any of the four anti-resonance frequencies.

Sequence input signal	Anti-resonance frequency selection 0/1
-----------------------	--

Function Select any of the four anti-resonance frequencies by setting two ON/OFF bits.

Anti-resonance frequency selection 1	Anti-resonance frequency selection 0	Anti-resonance frequency
OFF	OFF	Parameter #60*
OFF	ON	Parameter #61
ON	OFF	Parameter #62
ON	ON	Parameter #63

* The signal is assumed to be inactive at any time if it is not assigned to sequence input signals.

In this case, parameter #60 (anti-resonance frequency 0) becomes always valid.

To make anti-resonance frequencies invalid, set the anti-resonance frequency at 200.0Hz (factory shipment value).

Parameter setting To assign anti-resonance frequency 0 or 1 to a sequence input terminal, specify the corresponding value (“9”) or (“10”) to the parameter

Reference For details of the anti-resonance frequency, refer to Chapter 7

(9) Command pulse inhibition

Pulse string input ON/OFF for position control is selected.

Sequence input signal	Command pulse inhibition
-----------------------	--------------------------

Function While the command pulse inhibition signal (11) is ON, manual operation of the servo amplifier is valid.

It is used for manual forward operation [FWD] (15) or manual reverse operation [REV] (16) during position control. Switching between the pulse string operation and the manual operation is performed.

* When this signal is not allocated to the sequence input signal, it is considered to normally be OFF.

Therefore, when servo ON [RUN] (1) is turned ON, the pulse string input is always ON.

Parameter setting To allocate the command pulse inhibition to the sequence input terminal, set value (11) applicable to the parameter

For pulse string operation and manual operation

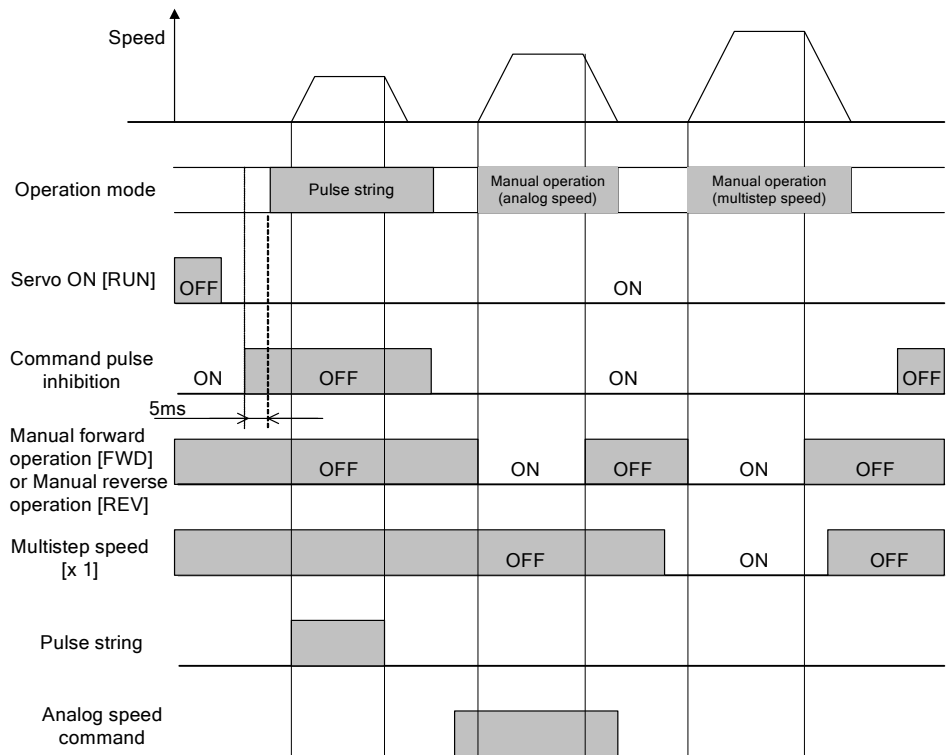

When only pulse string operation is performed

Allocation of the command pulse inhibition (11) is not required as shown below:

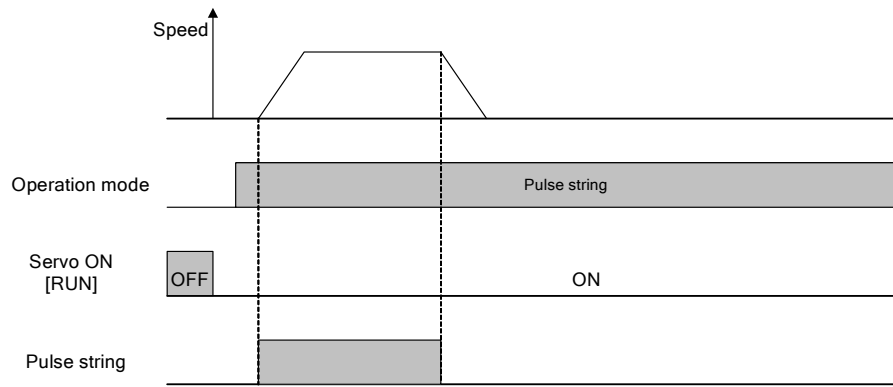

(10) Command pulse compensation α selection 0/1

Multiplying power of the machine movement is changed.

Sequence input signal	Command pulse compensation α selection 0/1
-----------------------	---

Function By switching the command pulse compensation α 0 (12) or command pulse compensation α 1 (13), either one of 4 command pulse compensation values is selected

Command pulse compensation

Command pulse compensation α selection 1	Command pulse compensation α selection 0	Pulse compensation value
OFF	OFF	Parameter #1
OFF	ON	Parameter #78
ON	OFF	Parameter #79
ON	ON	Parameter #80

Parameter setting To allocate the command pulse compensation α 0 or command pulse compensation α 1 to the sequence input terminal, set value (12) or (13) applicable to the parameter

Reference

(11) Control mode switching Control mode is switched

Sequence input signal Control mode switching

Function With ON/OFF of control mode switching (14), the control mode is switched.
Control mode switching is only valid when 3, 4 and 5 are set for parameter #09.

Control mode (parameter #09)

Parameter #09

Parameter reference value	Control mode switching	Control mode	
		Control mode switching = OFF	Control mode switching = ON
0	Invalid	Position control (fixed)	
1	Invalid	Speed control (fixed)	
2	Invalid	Torque control (fixed)	
3	Valid	Position control	Speed control
4	Valid	Position control	Torque control
5	Valid	Speed control	Torque control

Parameter setting To allocate the control mode switching to the sequence input terminal, set value (14) applicable to the parameter

Reference Refer to parameter #09 for details of the control mode

(12) Forward rotation command [FWD]/Reverse rotation command [REV]

It is the signal to rotate the servomotor

Sequence input signal

Forward rotation command [FWD]
Reverse rotation command [REV]

Function While the forward rotation command [FWD] (reverse rotation command [REV]) is ON, the servomotor rotates in the positive (negative) direction. When it is ON, acceleration starts. When it is OFF, deceleration starts.

(1) Speed control

The motor rotates at the voltage of the analog speed command input [Vref] terminal and at the speed selected from multistep speed [X1] and [X2].

(2) Position control

It is the same as speed control. The motor starts rotation when the forward rotation command [FWD] (reverse rotation command [REV]) is at the ON edge. If other [REV] or [FWD] signal is ON during rotation, it is ignored.

* Before starting manual operation, turn ON the “command pulse prohibited (11)” signal.

(3) Torque control

Torque is output from the servomotor shaft according to the torque command voltage.

Control mode	FWD/REV signal	Simultaneous FWD/REV ON
Speed control	ON level	Deceleration stop
Position control	ON edge	Motion immediately before simultaneous ON is maintained.
Torque control	ON level	Deceleration stop

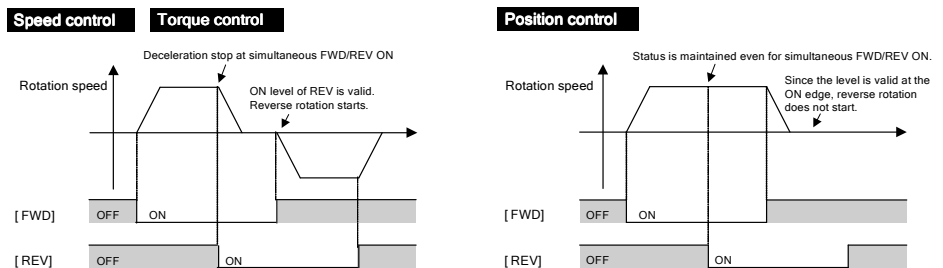

Parameter setting To allocate the forward rotation command [FWD] signal to the sequence input terminal, set value (15) applicable to the parameter. ((16) for the reverse rotation command.)

When this signal is not allocated to the sequence input terminal, it is considered to normally be OFF.

Reference (1) Gain of analog speed command input [Vref] terminal (for speed command)

The motor shipped from the factory rotates at the maximum rotation speed [r/min] (Note 1) of the motor in the forward rotation direction for the speed command voltage of + 10 [V].

When parameter #70 is set, the rotation speed ratio for the speed command voltage can be changed. When the reference value for parameter #70 is 0.1, the rotation speed can be (Maximum rotation speed x 0.1) [r/min] for the speed command voltage of +10 [V].

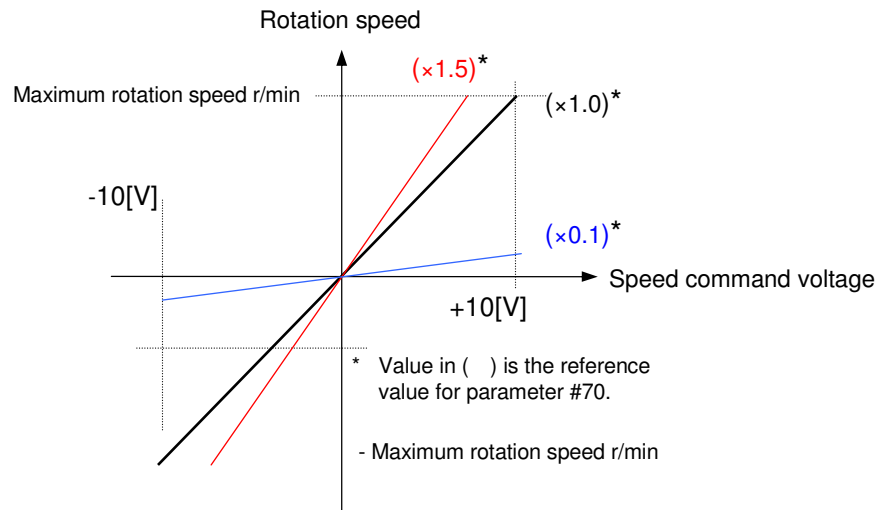

Note 1) The actual rotation speed of the motor has a tolerance of ± 10 [V]/ \pm Maximum rotation speed $\pm 1\%$ [r/min] due to variation of individual servo amplifiers and servomotors.

To make a fine adjustment of the rotation speed, adjust parameter #70 above.

BSM (0.1-0.75 kW) ± 10 V / $\pm 5000 \pm 1\%$ [r/min]

BSM (1.0-2.0 kW) ± 10 V / $\pm 3000 \pm 1\%$ [r/min]

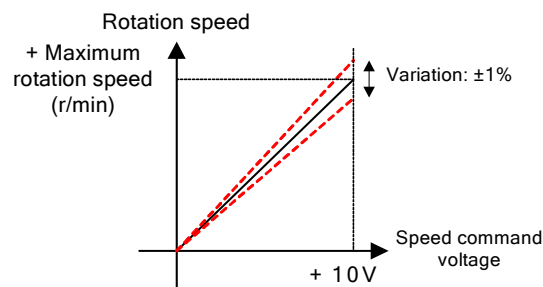

(2) Resolution of analog speed command input voltage

The analog speed command input voltage [Vref] terminal has a resolution of 14 bits in full scale.

(13) Multistep speed 1 [X1]/2 [X2] The setting speed for manual operation is selected

Sequence input signal	Multistep speed 1 [X1]/2 [X2]
-----------------------	-------------------------------

Function By switching the multi-step speed 1 [X1]/2 [X2] signals, any of the four multi-step speeds will be selected.

Selection of multistep speed

X2	X1	Rotation speed
OFF	OFF	Analog speed command input [Vref] terminal
OFF	ON	Parameter #31
ON	OFF	Parameter #32
ON	ON	Parameter #33

(1) Speed control

The motor rotates at the voltage of the analog speed command input [Vref] terminal and at the speed selected in multistep speed [X1] and [X2].

(2) Position control

It is the same as speed control.

* Before starting manual operation, turn ON the “command pulse prohibited (11)” signal.

Parameter setting To allocate the multistep speed 1 [X1] and 2 [X2] to the sequence input terminal, set value (17) or (18) applicable to the parameter

(14) Acceleration/deceleration time selection	Acceleration/deceleration time in manual operation is selected
Sequence input signal	Acceleration/deceleration time selection

Function By switching the acceleration/deceleration time selection signals, either one of 2 acceleration/deceleration times is selected.

The acceleration time and the deceleration time of the servomotor are determined according to parameters #35 to 38. The acceleration time can be set separate from the deceleration time.

The acceleration time is not dependent on the rotation direction, and is on parameter #35 (#37). Parameters #35 and 37 can be switched with the acceleration/deceleration time selection signal.

Acceleration/deceleration time

Acceleration/ deceleration selection	Acceleration time	Deceleration time
OFF	Parameter 35	Parameter 36
ON	Parameter 37	Parameter 38

Parameter setting To allocate the acceleration/deceleration time selection signal to the sequence input terminal, set value (19) applicable to the parameter. When this signal is not allocated to the sequence input terminal, it is considered to normally be OFF

(15) Current limit valid/current limit detection	The maximum output torque of the servomotor can be limited	Current limit valid/current limit detection
---	--	---

Sequence input/output signal

Function (1) Current limit valid

While the current limit valid (20) signal is ON, the output torque of the servomotor can be limited. The torque limit value can be set in the range from 0 to 300 at the increments of 1 [%] to parameter #25. The maximum output torque is set as 100[%] rated torque.

Current limit is always valid for all control types.

When the output torque is limited during acceleration or deceleration, the acceleration/deceleration time in parameter setting may not be observed.

(2) Current limit detection

This signal is ON while the output torque of the servomotor has reached the torque limit value.

The output of current limit detection (10) is valid for all control types.

Parameter setting To allocate the current limit valid signal to the sequence input terminal, set value (20) applicable to the parameter.

When the current limit valid (20) signal is not allocated to the sequence input terminal, the reference value for parameter 25 is always valid.

To allocate the current limit detection signal to the sequence input terminal, set value (10) applicable to the parameter.

Reference

(16) Coasting [BX] The servomotor is forcibly set to coasting

It is safe that this signal is not used for moving the machine in the vertical direction

Sequence input signal	Coasting [BX]
-----------------------	---------------

Function While the coasting (BX) signal is ON, the servo amplifier output is shutoff and the servomotor is coasting. The output shaft of the servomotor is decelerated (accelerated) with the load torque.

The coasting signal is valid for all control status (position control, speed control and torque control).

While the signal is ON during position control, the servomotor is coasting. When positioning control is performed with the pulse string, the number of output pulses on the upper level controller does not match the rotation of the servomotor.

During speed control and torque control, the servomotor is coasting as is. If the coasting signal is turned OFF during deceleration, the command speed or the command torque is output.

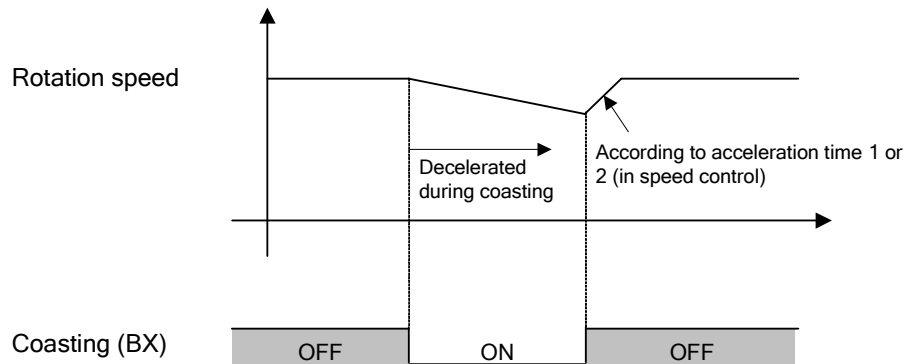

Parameter setting To allocate the coasting signal to the sequence input terminal, set value (21) applicable to the parameter

Reference Coasting is a valid signal by priority in all control modes

(17) Ready [RDY] The signal is activated when the motor is ready to rotate

Sequence output signal

Ready [RDY]...Assigned to OUT 1 with shipment setting

Function The signal is activated when the following conditions are satisfied:

- 1) Servo ON [RUN] (1) signal ON
- 2) Active forced stop [EMG] (5) signal*
- 3) Inactive alarm detection: a-contact (3) signal (Or active alarm detection: b-contact (4) signal)
- 4) Active external regenerative resistor overheat (8) signal*
- 5) Source voltage above 150V
- 6) Coasting [BX] (21) signal OFF

* Conditions 2) and 4) are ignored if the corresponding signal is not assigned to the CONT terminals.

The host controller recognizes the ready [RDY] signal to check if the servomotor is ready to rotate.

Parameter setting To allocate the ready [RDY] signal to the sequence input terminal, set value (1) applicable to the parameter

(18) Positioning end [PSET] Use the signal to check that the positioning action has been completed

Sequence output signal

Positioning end [PSET]...Assigned to OUT 2 with shipment setting

Function The signal is active when the following conditions are satisfied.

- 1) There is no alarm.
- 2) The rotation speed is within the zero speed width specified at parameter #23.
- 3) The deviation amount is within zero deviation width specified at parameter #21.
- 4) The above conditions remain arranged for the positioning end judgment time specified at parameter #24.

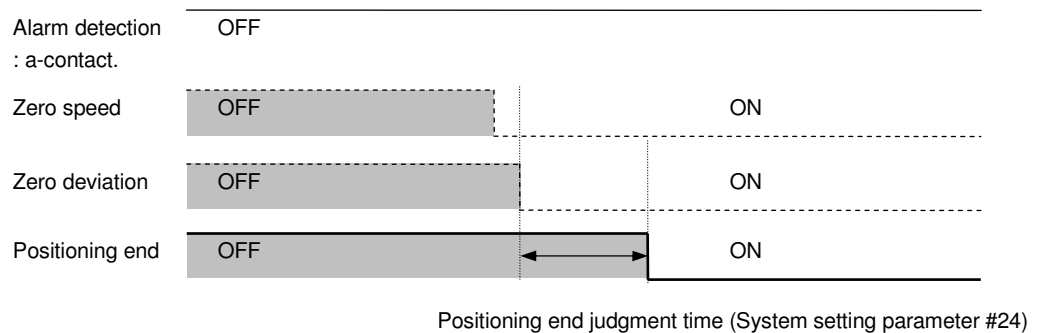

Parameter setting To allocate the positioning end [PSET] signal to the sequence input terminal, set value (2) applicable to the parameter

Reference (1) When the power is supplied

It takes about 1.5 seconds from the power supply to defined position control of the servo amplifier. The positioning end signal is ON 1.5 seconds after the power is supplied.

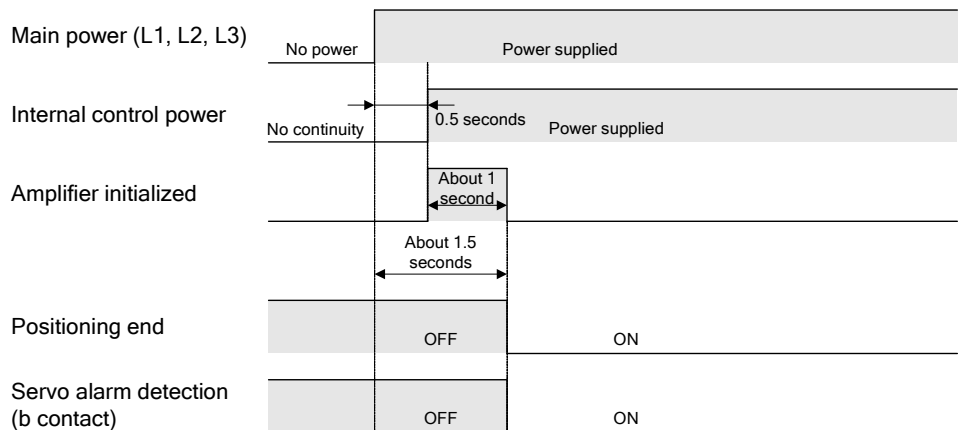

(2) Position control

When the difference (deviation) between the command position (pulse string input) and the feedback position is zero deviation width (parameter 21) or less and the rotation speed is zero speed width (parameter 23) or less, the signal is ON.

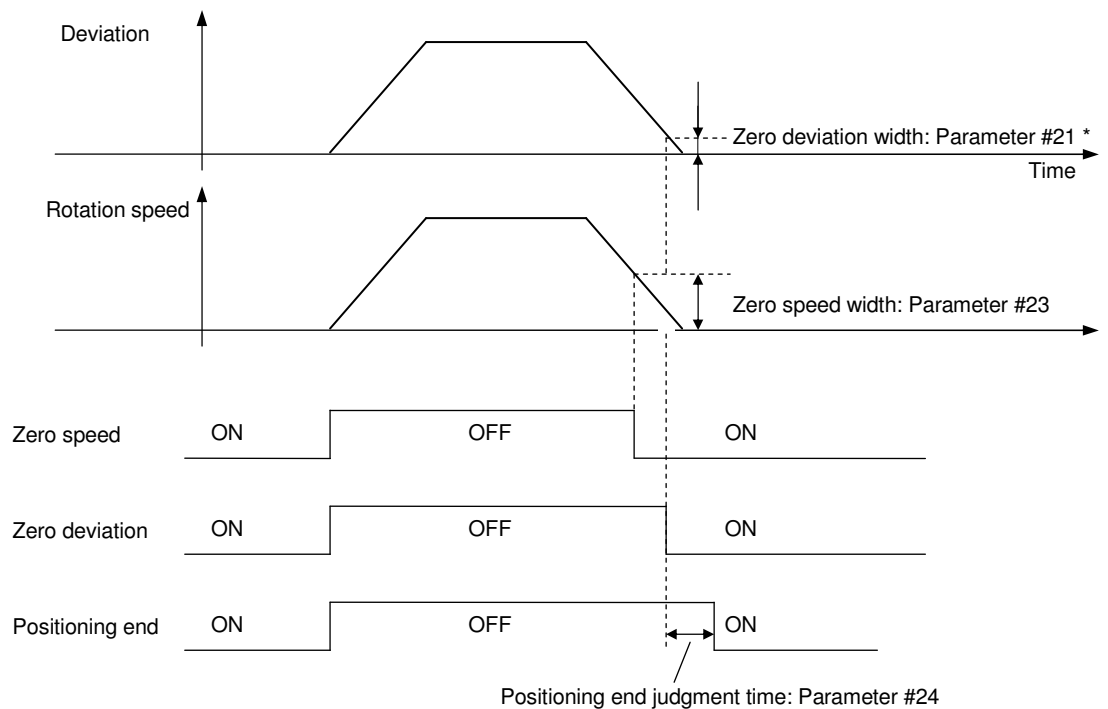

* The unit uses encoder pulses (131072 pulses).
 For details, refer to page 5-55.

(3) Positioning end (PSET) output for alarm detection

Positioning end (PSET) for alarm detection

Factor	Deceleration method	Positioning end signal	Remark
Servo ON [RUN] OFF	Forced zero speed - Base OFF	ON during stop	Ready [RDY] signal OFF
Forced stop [EMG] OFF	Forced zero speed	OFF	ON when forced stop is reset.
+OT, -OT detection	Forced zero speed - Servo lock	ON during stop	Rotation is available with pulse string, forward rotation command and reverse rotation command.
Alarm detection (minor failure)	Forced zero speed - Base OFF	OFF when alarm is detected.	ON when alarm is reset.
Alarm detection (major failure)	Base OFF	OFF when alarm is detected.	ON when alarm is reset.

Note) Minor failure - Deviation limit (OF), regenerative resistor overheating (rH1), amplifier overheating (AH), undervoltage (Lv)

Major failure - Failure detection other than minor failure

Forced zero speed - Decelerated at the maximum capacity of the servomotor.

Base OFF - No drive power on the servomotor (coasting).

(19) Alarm detection: a-contact (b-contact) The servo amplifier detects the action (alarm) of protection function to activate (deactivate)* the signal.

Sequence output signal	Alarm detection: a-contact
	Alarm detection: b-contact ... Assigned to OUT 3 with shipment setting

Function The signal is activated (deactivated*) and is held at the servo amplifier when the servo amplifier detects an alarm. After the cause of the alarm is removed, the signal is deactivated (activated*) upon the activating edge of the reset signal [RST] so that operation is resumed.

The host controller recognizes the alarm detection signal to check for an alarm.

* Description in parentheses () is for b-contact alarm detection.

<Precaution for usage of b-contact alarm detection>

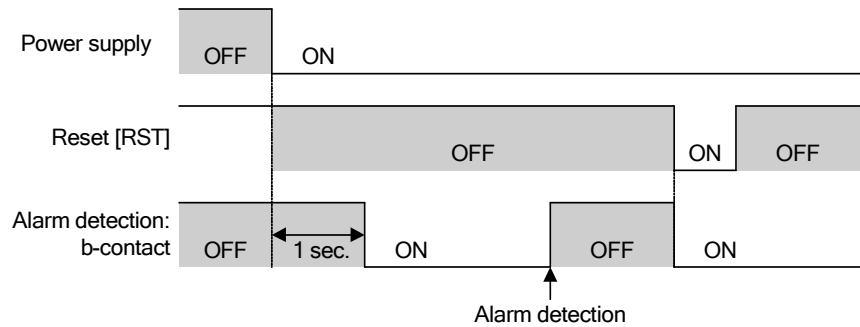

Make sure that the signal is inactive for about one second after the power is turned on.

Parameter setting To assign a- or b-contact alarm detection to the sequence output terminal, specify the corresponding value ("3" or "4") to the parameter

(20) Dynamic brake This signal is ON when the servo amplifier detects a specific alarm *.

Sequence output signal	Dynamic brake
------------------------	---------------

Function This signal is ON when the servo amplifier detects a specific alarm * that cannot drive the servomotor, and the signal is maintained until input of the alarm reset signal.

When the dynamic brake is applied, three phases of the synchronous motor are short-circuited to generate power. After the output shaft of the servomotor is stopped, no braking force generates.

The output terminal of the dynamic brake is +30VDC, 50mA. Because the electromagnetic contact cannot be driven directly, use a general relay or solid-state contactor (SSC).

Parameter setting To assign the dynamic brake to the sequence output terminal, specify the corresponding value (“5”) to the parameter

Reference • Specific alarm

The motion changes to coasting at the same time the alarm is detected.

Indication	Description
OC1	Overcurrent 1
OC2	Overcurrent 2
OS	Overspeed
HV	Overvoltage
Et	Encoder trouble
Ct	Control power alarm
dE	Memory alarm
rH2	Regenerative transistor overheat
EC	Encoder communication alarm
Cnt	CONT duplication
OL	Overload

* At occurrence of the alarm, only overload motion is decelerated at the maximum capacity. When the signal stops, the servomotor is coasting.

(21) Zero deviation This can confirm that the servomotor has almost reached the command position

Sequence output signal	Zero deviation
-------------------------------	----------------

Function The signal is ON when the difference (position deviation) between the current command position and the current feedback position is within the reference value for parameter #21.

The zero deviation signal is valid at the position control mode.

The signal is always ON in control status (torque control, etc.) other than the position control.

Reference value level for parameter #21 is not related to positioning accuracy.

Parameter setting To allocate the zero deviation signal to the sequence input terminal, set value (8) applicable to the parameter

(22) Zero speed This signal is ON when the rotation speed of the servomotor is almost 0 (zero)

Sequence output signal	Zero speed
------------------------	------------

Function This signal is ON when the actual rotation speed of the servomotor is reference value or less for parameter #23

Parameter setting To allocate the zero speed signal to the sequence input terminal, set value (9) applicable to the parameter

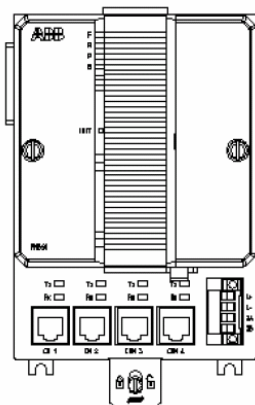

← Zero speed



(23) Brake timing This is the timing signal to automatically turn the servomotor brake ON/OFF

Sequence output signal	Brake timing
------------------------	--------------

Function The timing signal that automatically excites/releases the servomotor brake is output according to the servo ON signal

Parameter setting To allocate the brake timing output signal to the sequence input terminal, set value (11) applicable to the parameter.

When this signal is not allocated to the sequence input terminal, it is considered to normally be OFF

Reference (1) Brake timing

The procedures to set the brake timing signal to the sequence output terminal are as follows:

1) Setting of sequence output terminal

Set value (11) applicable to brake timing to either one of parameters #15 to 18. If [11] is set to #15, the OUT1 terminal is the brake timing output.

2) Brake operation time

Set the operation time of the external brake at parameter #73. Add the scan time of the programmable logic controller (PLC), and the response time of the external relay, electromagnetic contactor and brake to this value.

Brake operation time: Time setting from output OFF of the servo amplifier to actual operation of the external brake

Parameter #73

No.	Description	Setting range	Initial value	Change
73	Brake operation time	0.01 - 9.99 sec. (in 0.01 increments)	0.00	Always

(2) Brake timing chart

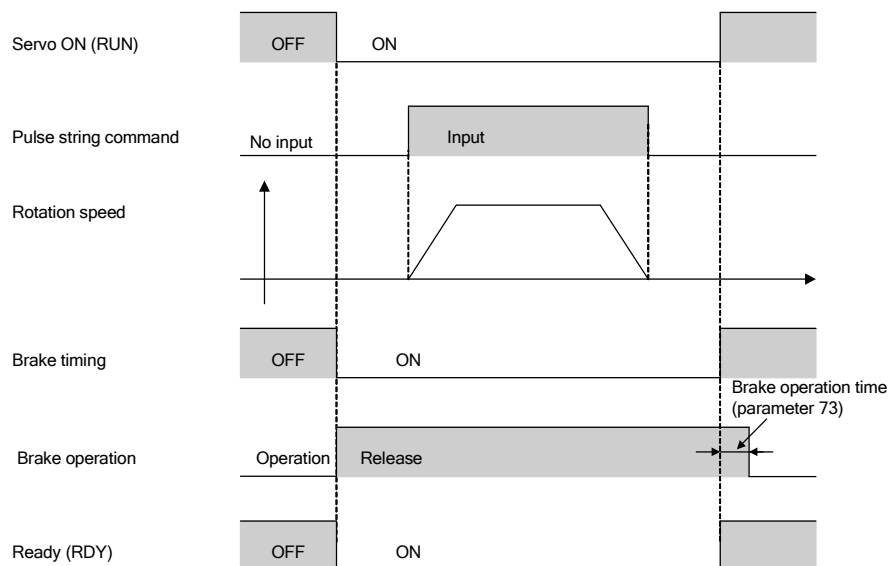

(3) Timing chart for alarm detection

If an alarm is detected, the brake is immediately activated without waiting for stoppage.

The brake is used for retention. Operation of the brake during rotation may shorten the life of the brake. Avoid repeated operation.

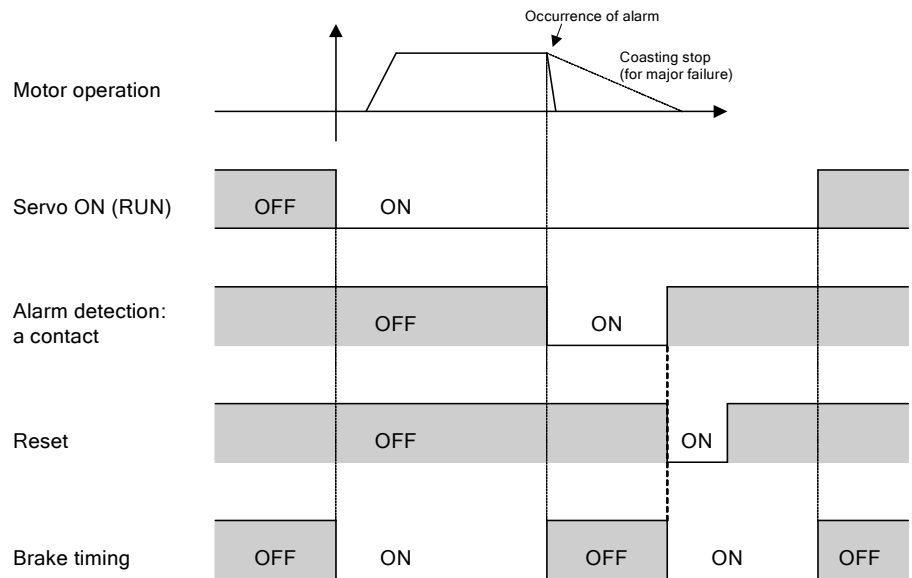

Connection example of
brake timing signal (0.4
[kW] or less)

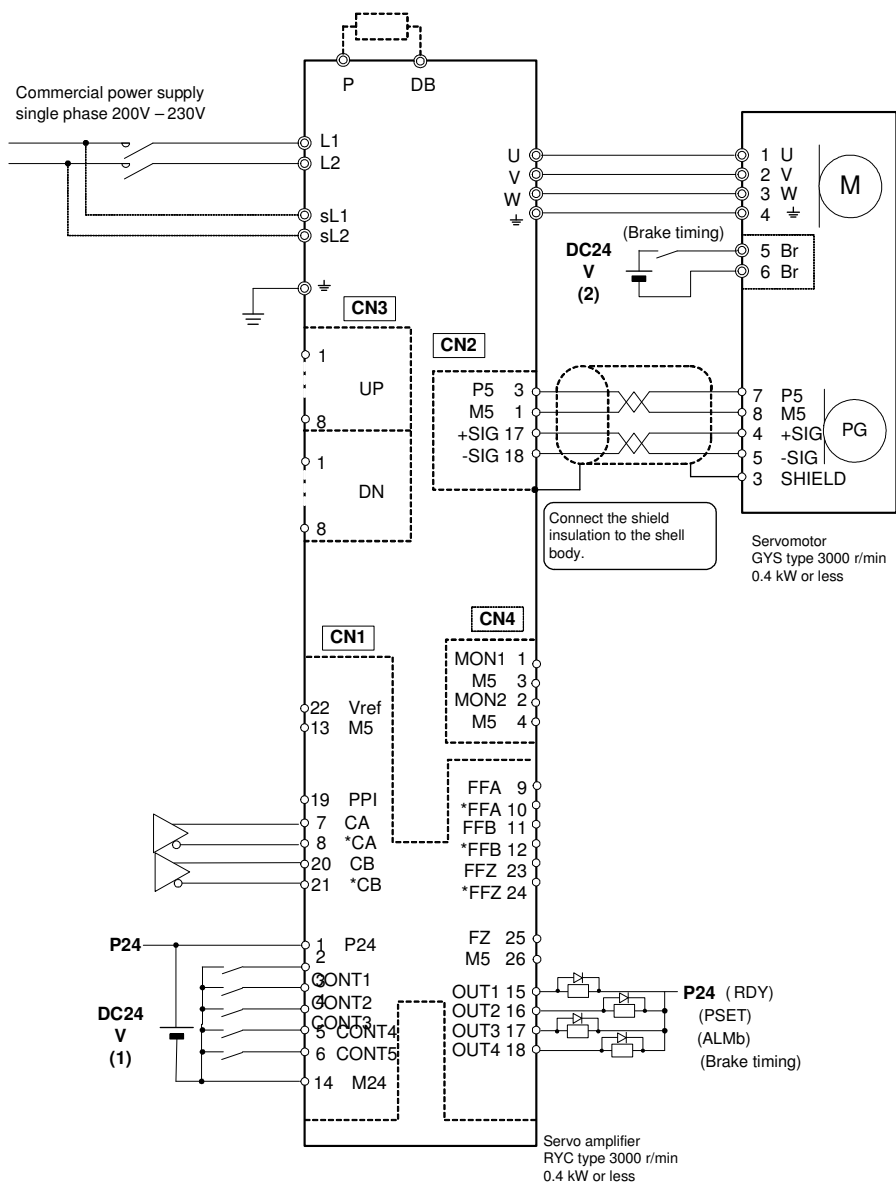

- * Prepare DC24V separately for the sequence input/output power source (1) and the motor brake power source (2).
- * Set 11 (brake timing) to parameter #18 (CONT4 allocation).

Parameter #19



Parameter #19

No.	Name	Setting range	Initial value	Change
19	Output pulse count	16 to 32768 [pulse] (in 1 increments)	2048	Power

Specify the number of pulses output per each revolution of the servomotor.

The output form is two signals having 90-degree phase difference.

When the servomotor output shaft is rotating forward, B phase advance signal is output. By setting the rotation direction switching (parameter #4), the phase sequence can be changed.

- When the parameter # 4 reference value is 1 or 2, the signal is B phase advance for counterclockwise rotation.
- When the parameter # 4 reference value is 1 or 2, the signal is A phase advance for counterclockwise rotation.

The number of pulses output from the frequency dividing output terminals ([FA], [*FA], [FB], [*FB] and [*FZ] terminals) of the servo amplifier can be specified.

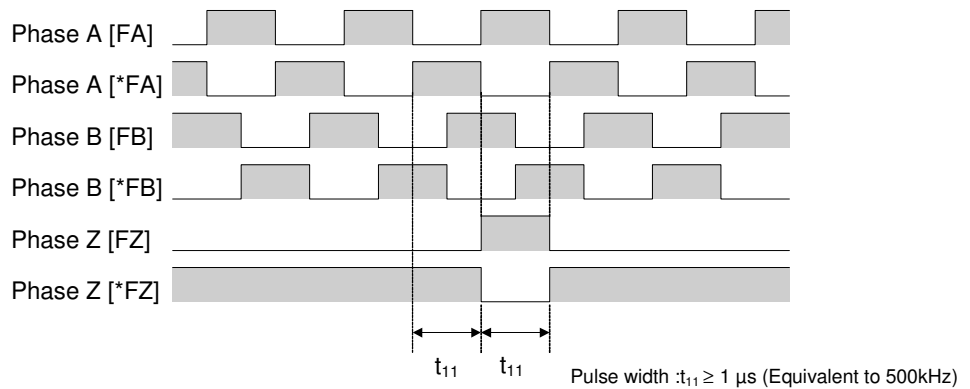

The phase-A and phase-B signals are 50% duty.

A single pulse of the phase-Z signal is output in each revolution. The output width depends on the number of output pulses.

The phase-A and phase-Z signals are synchronized with each other.

Use about 500kHz output frequency. There is no limit in the output frequency of the servo amplifier.

There is no relationship between the position of the output shaft of the servomotor and the phase-Z signal.



Number of output pulses during rotation at 5000 [r/min] with an output pulse count setting of 3000

$$\frac{3000[\text{pulse/rev}]}{60} \times 5000[\text{r/min}] = 250000[\text{Hz}]$$

The number of output pulses exceeds 2.7 [MHz] with maximum 32768 [pulses/rev] and 5000 [r/min].

Parameter #20



Parameter #20

No.	Name	Setting range	Initial value	Change
20	Phase-Z offset	0 to 65535[×2 pulses] (in 1 increments)	0	Power

Specify the parameter to change the output position of the phase-Z signal.

There is a counterclockwise delay in the output position of the phase-Z signal by the number of pulses specified in parameter #20.

This parameter has no relations with the direction of rotation switch (parameter #4).

$$\frac{(\text{Phase-Z offset } [\times 2 \text{ pulses}])}{131072 \text{ pulses/rev}} = Z [\text{rev}]$$

Counter clockwise

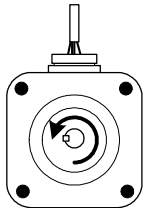

There is a counterclockwise delay in the output position of the phase-Z signal by Z revolutions.

Output position of phase-Z signal

When the phase-Z offset is “0”

· When phase-Z offset is “16384”

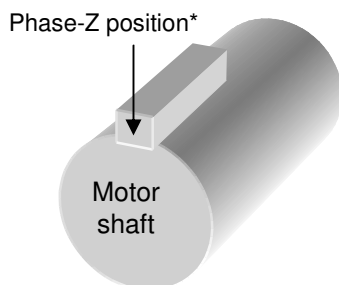

$$\frac{16384 \times 2 \text{ pulses}}{131072 \text{ pulses/rev}} = \frac{1}{4} [\text{rev}]$$

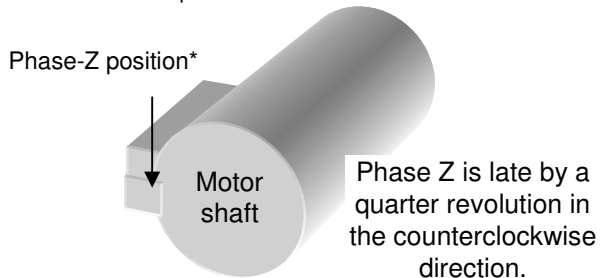

*The position of the key is not phase Z. The position of the key is assumed to be phase Z for explanation.

Reference Adjustment of the phase-Z position can be made in the test operation mode of the keypad panel so that the current position becomes the position where the phase-Z signal is issued.

 Refer to page 8-24.

Precaution for detection of phase-Z signal for origin returning action

When the rotation speed is 100 [r/min] or less and the motor shaft rotation angle is advanced (released) 372°(machine angle) from the home position return limit switch (home position LS), perform the home position return operation.
If the angle is not released 372°or more, the motor may rotate another one turn when the home position return is completed.

Parameter #21



Parameter #21

No.	Name	Setting range	Initial value	Change
21	Zero deviation width	1 to 20000 [pulse] (in 1 increments)	400	Always

* It is only valid for position control.

Specify the width of the zone where the zero deviation signal is activated* in the number of encoder pulses.

The unit is equivalent to the number of encoder feedback pulses (not command pulses).

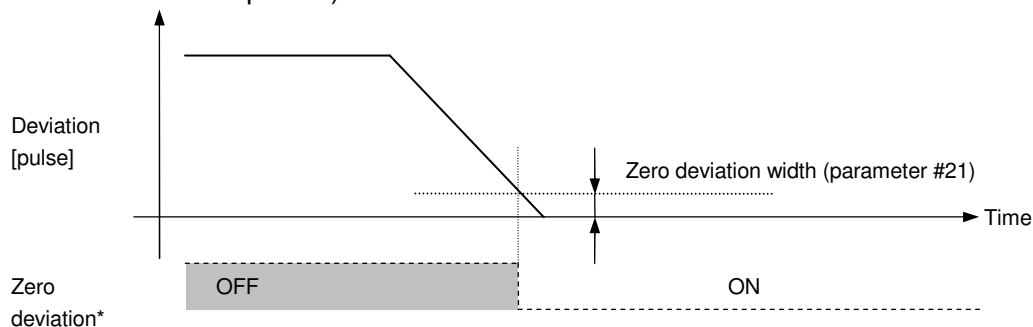

If both the zero deviation signal (parameter #21) and zero speed signal (parameter #23) remain active in the positioning end judgment time specified in parameter #24, the positioning end signal is activated.

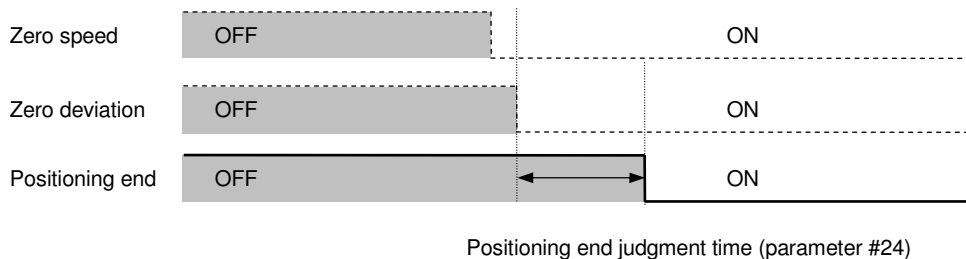

When the precision of ± 10 [μm] is desired for a machine with ball screw fastening and the lead of 10 [mm].

$$\frac{131072[\text{pulse/rev}]}{\text{Movement per rotation [m]}} \times (\text{Required precision [m]}) = \text{Zero deviation width [pulse]}$$

$$\frac{131072[\text{pulse/rev}]}{10 \times 10^{-3} [\text{m}]} \times (10 \times 10^{-6} [\text{m}]) = 131.072 \approx 131 [\text{pulse}]$$

Set [131] to zero deviation width (parameter #21).

Parameter #22



Parameter #22

No.	Name	Setting range	Initial value	Change
22	Deviation limit width	10 to 65535 [$\times 100$ pulse] (in 1 increments)	20000	Always

* It is only valid for position control.

Specify the number of pulses for detecting the deviation limit (for alarm detection) in the number of encoder feedback pulses (not command pulses).

The initial setting is “20000,” so that deviation is detected at 2000000 pulses.

With the initial setting, deviation is detected if the difference between the command position and feedback position is equivalent to about 15.2 revolutions of the servomotor shaft.

The deviation limit width is provided for alarm detection.

Parameter #23



Parameter #23

No.	Name	Setting range	Initial value	Change
23	Zero speed width	10 to 5000 [r/min] (in 1 increments)	50	Always

Use the parameter to judge if the servomotor is stopped. Specify the width where the zero speed signal is activated*

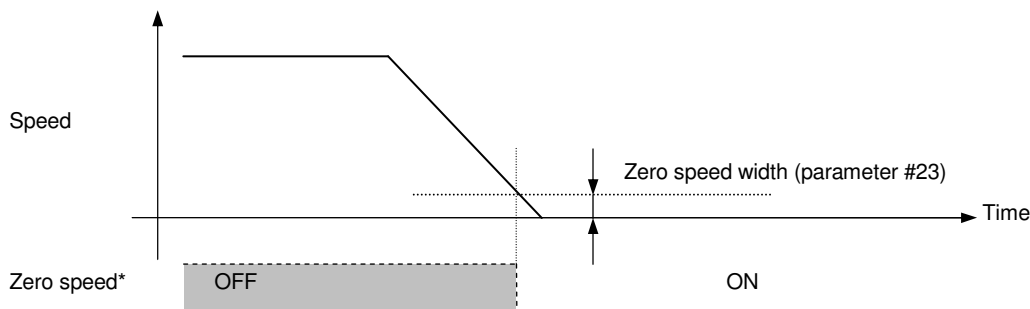

If the zero deviation signal (parameter #21) and zero speed signal (parameter #23) remain active in the positioning completion judgment time specified in parameter #24, the positioning end signal is activated

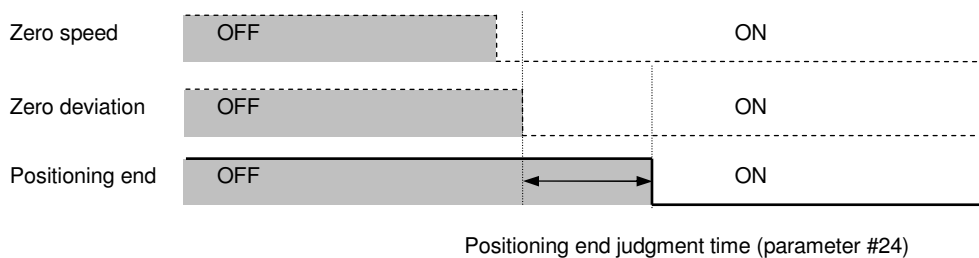

Parameter #24



Parameter #24

No.	Name	Setting range	Initial value	Change
24	Positioning end judgment time	0.000 to 1.000 sec. (in 0.001 increments)	0.000	Always *

It is only valid for position control.

Specify the time for judgment of the end of positioning.

If the zero deviation signal (parameter #21) and zero speed signal (parameter #23) remain active in the positioning end judgment time (parameter #24), the positioning end signal is activated.

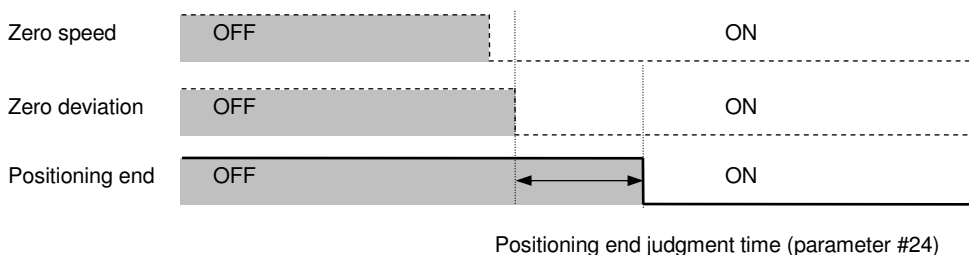

Parameter #25



Parameter #25

No.	Name	Setting range	Initial value	Change
25	Max. current limit	0 to 300 % (in 1 increments)	300	Always

Specify the output torque limit of the servomotor.

This setting is specified as shown in the table below according to the sequence input signal torque limit (20) setting.

Allocation of current limit signal		Description of operation
No		Normally ON (parameter #25 reference value)
Yes	OFF	Maximum torque
	ON	ON (parameter #25 reference value)

Parameter #26



Parameter #26

No.	Name	Setting range	Initial value	Change
26	Undervoltage alarm detection	0: No detection, 1: Detection	1	Power

Specify whether or not alarm detection is made upon detection of undervoltage in the power supply under active servo on [RUN]

Parameter #27



Parameter #27

No.	Name	Setting range	Initial value	Change
27	Operation for undervoltage	0: Sudden deceleration and stop 1: Coasting	0	Power *

It is only valid for speed control.

While the servo on (RUN) signal is ON, the servomotor operation is specified for detection of undervoltage of the power supply.

Parameter #27

Setting range	Operation for detection of undervoltage
0: Sudden deceleration and stop	The system decelerates and stops at the maximum capacity of the servo amplifier.
1: Coasting	The system decelerates (accelerates) with the load torque for coasting.

Parameter #28



Parameter #28

No.	Name	Setting range	Initial value	Change
28	For adjustment by manufacturer	-	Adjustment value	-

This parameter is for adjustment by manufacturer. Do not change it.

Parameter #29



Parameter #29

No.	Name	Setting range	Initial value	Change
29	Parameter write-protection	0: Write-enable, 1: Write-protected	0	Always

Parameter editing is prohibited.

Even if write-protection is selected with parameter #29, parameter #29 can be edited.

Parameter #30



Parameter #30

No.	Name	Setting range	Initial value
30	Initial display of the keypad	0 to 20 (in 1 increments)	0

Specify the initial display of the keypad immediately after the power is supplied.

Parameter #30

Setting	Description	Display
0	Operation mode	
1	Current alarm	
2	Alarm history	
3	Station No. setting	

Setting	Description	Display
4	Feedback speed	
5	Command speed	
6	Average torque	
7	Current feedback position	
8	Current command position	
9	Position deviation	
10	Feedback cumulative pulse	
11	Command cumulative pulse	
12	Peak torque	
13	Input voltage	
14	Input/output signal	
15	Load inertia ratio	
16	OL thermal value	
17	Regenerative resistor thermal value	
18	Pulse string input frequency	
19	DC link voltage (maximum value)	
20	DC link voltage (minimum value)	

Refer to Chapter 8 Keypad for details of each display

Parameter #31-#33

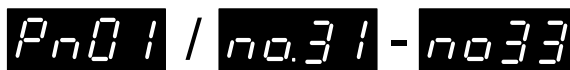

Parameters #31 to 33

No.	Name	Setting range	Initial value	Change
31	Manual feed speed 1 (and test operation)	0.1 - (Maximum rotation speed) [r/min] (in 0.1 increments)	100.0	Always
32	Manual feed speed 2	0.1 - (Maximum rotation speed) [r/min] (in 0.1 increments)	500.0	Always
33	Manual feed speed 3	0.1 - (Maximum rotation speed) [r/min] (in 0.1 increments)	1000.0	Always

* It is valid for position control and speed control.

The rotation speed of the forward rotation command [FWD] (reverse rotation command [REV]) signal can be specified.

ON/OFF combination of X1 and X2 signals can change the rotation speed.

The rotation speed can be changed during operation of the servomotor. It is not related to the parameter sequence and the degree of the reference value.

Selection of multistep speed

X2	X1	Rotation speed
OFF	OFF	Analog speed command input [Vref] terminal
OFF	ON	Standard parameter #31
ON	OFF	Standard parameter #32
ON	ON	Standard parameter #33

Parameter #34



Parameter #34

No.	Name	Setting range	Initial value	Change
34	Maximum rotation speed	0.1 - (Maximum rotation speed) [r/min] (in 0.1 increments)	5000.0 (3000.0)	Always

* Value in () is the initial value of the BSM (1.0-2.0 kW) motor.

Set the upper limit of the servomotor rotation speed specified with the parameter and the analog speed command input.

During torque control, the difference between the reference value and the actual rotation speed of the servomotor is about 100 [r/min].

(It is because speed control is not performed.)

The setting of the maximum rotation speed is not valid for position control of the pulse string input.

* The initial value of the BSM (0.1-0.75 kW) motor is 5000.0 [r/min].

* The initial value of the BSM (1.0-2.0 kW) motor is 3000.0 [r/min].

Parameter #35 - #38



Parameters #35 to 38

No.	Name	Setting range	Initial value	Change
35	Acceleration time 1	0.000 - 9.999 sec. (in 0.001 increments)	0.100	Always
36	Deceleration time 1	0.000 - 9.999 sec. (in 0.001 increments)	0.100	Always
37	Acceleration time 2	0.000 - 9.999 sec. (in 0.001 increments)	0.500	Always
38	Deceleration time 2	0.000 - 9.999 sec. (in 0.001 increments)	0.500	Always

It is valid for position control and speed control.

Acceleration/deceleration time of the servomotor can be set.

It is valid for all acceleration/deceleration during speed control and position control (excluding the pulse string input).

The time setting is from 0 (zero) to 2000 [r/min].

Acceleration time 2 and deceleration time 2 are valid while the acceleration/deceleration time selection signal is ON. ON/OFF of the acceleration/deceleration time selection is always ON. The acceleration time/deceleration time is changed in a similar manner.

The acceleration/deceleration time selection signal is the control allocation signal of the parameter.

External selection of acceleration/deceleration time

Acceleration/deceleration time selection (19)	Acceleration time	Deceleration time
OFF	Parameter 35	Parameter 36
ON	Parameter 37	Parameter 38

Acceleration time 1 can be set separate to deceleration time 1. Only the deceleration time can be increased. Deceleration time can be used depending on load including movement of a carrier.

When the analog speed command voltage is output with the upper level control unit and the feedback from the dividing output of the servo amplifier is used for position control, set the acceleration time and the deceleration time to 0.000 sec

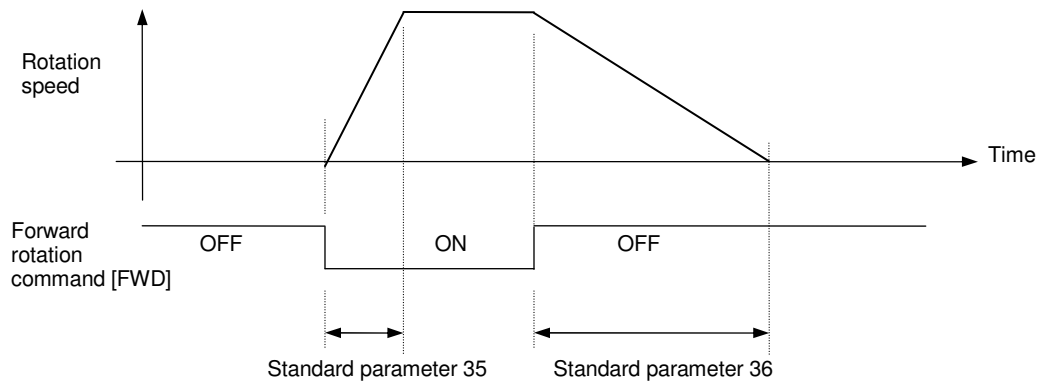

Parameter #39



Parameter #39

No.	Name	Setting range	Initial value	Change
39	Zero clamp level	0.0 - 500.0 [r/min] (in 0.1 increments)	0.0	Always

* It is valid for position control and speed control.

This sets the rotation speed of the servomotor in zero clamp.

When the analog speed command of position control and speed control is input, this signal is valid.

When the speed command value of the analog speed command input (Vref) terminal is zero clamp level or less, the rotation speed is zero clamped. Drift of the analog speed command input value is prevented near zero.

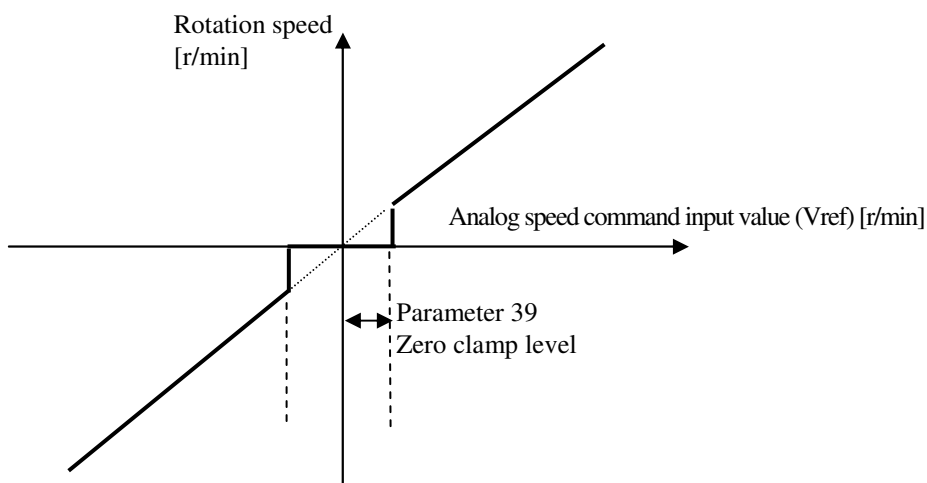

Note For analog voltage around the reference value, the command may fluctuate between "zero" and "reference value," resulting in an unstable motor shaft

Control system settings Control system setting parameters are described in the order of the parameter number.

Control block diagram

The control block diagram of BSD Series is shown.

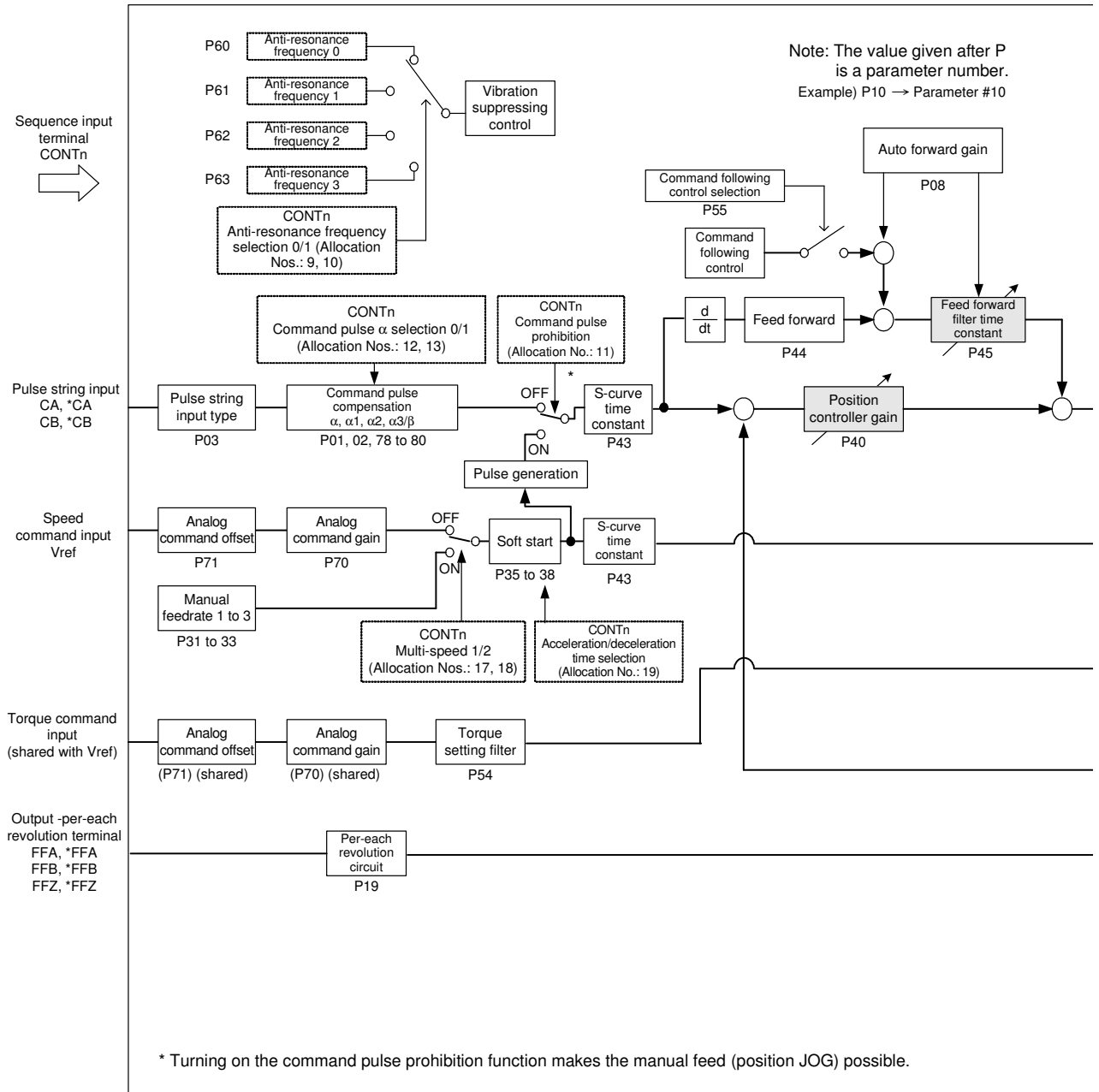

Note: The value given after P is a parameter number.
 Example) P10 → Parameter #10

Control mode selection:
 for P09=3 (Position ↔ Speed)

Control mode selection:
 for P09=4 (Position ↔ Torque)
 or 5 (Speed ↔ Torque)

CONTn
 Control mode selection
 (Allocation No.: 14)

CONTn
 Control mode selection
 (Allocation No.: 14)

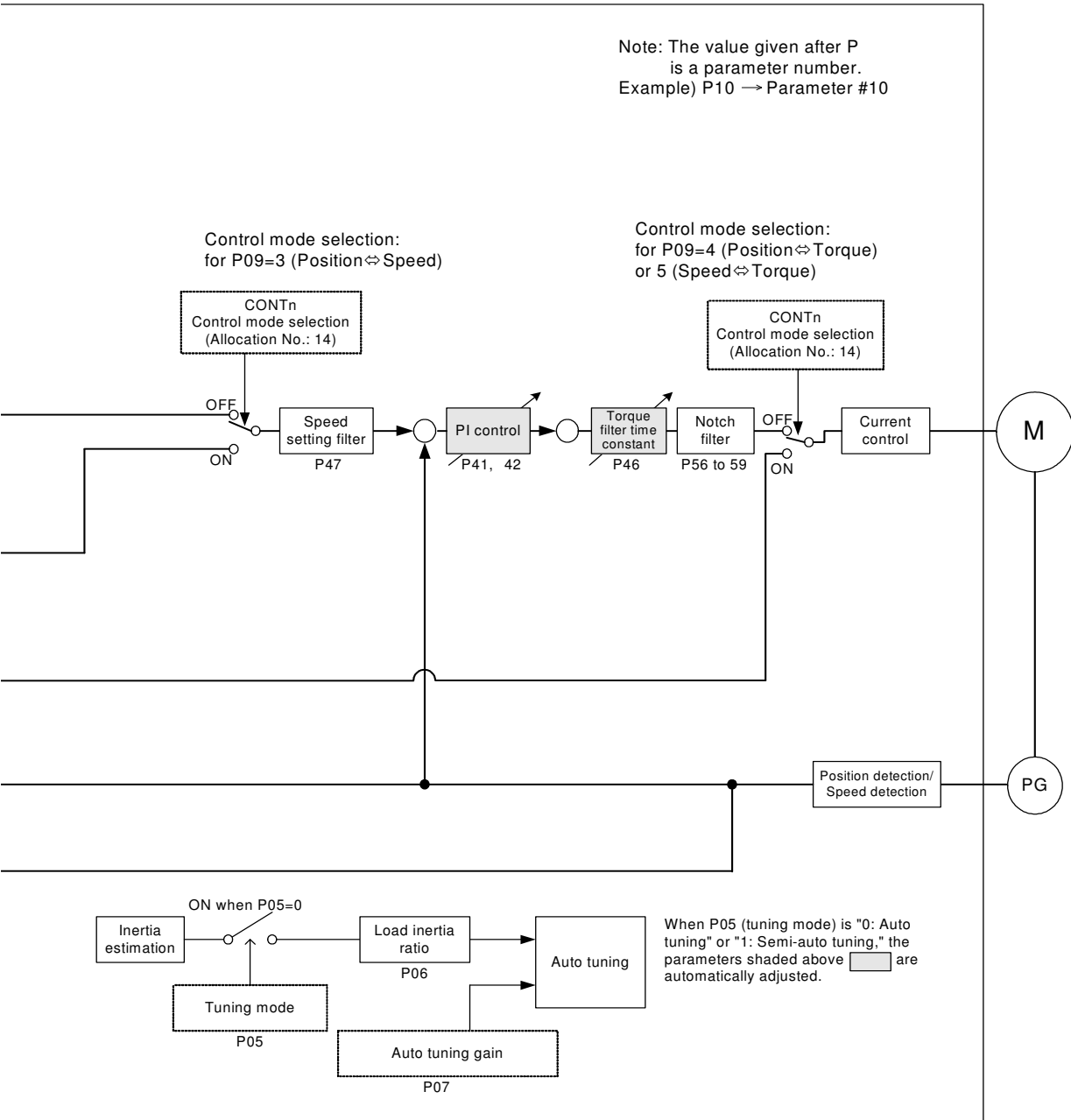

Parameter #40 - #42



Parameters #40 through #42

No.	Name	Setting range	Initial value	Change
40	Position controller gain 1	1 to 1000 [rad/sec] (in 1 increments)	77	Always
41	Speed response 1	1 to 1000 [Hz] (in 1 increments)	57	Always
42	Speed controller integration time 1	1.0 to 1000.0 [msec] (in 0.1 increments)	25.9	Always

* The initial value is for the BSM (0.1-0.75 kW) motor.

Parameter #45 - #46

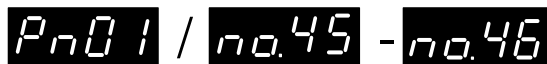

Parameters #45 and #46

No.	Name	Setting range	Initial value	Change
45	Feed forward filter time constant	0.0 to 250.0 [msec] (in 0.1 increments)	12.9	Always
46	Torque filter time constant	0.00 to 20.00 [msec] (in 0.01 increments)	0.31	Always

* The initial value is for the BSM (0.1-0.75 kW) motor.

* It is valid for position control and speed control.

No. 40 and No. 45 are only valid for position control.

These parameters are automatically updated when “auto tuning” or “semi-auto tuning” is selected at basic setting parameter #5.

Specify them when “manual tuning” is selected.

No.	Name	Tuning mode		
		0: Auto	1: Semi-auto	2: Manual
06	Load inertia ratio	-	O	O
07	Auto tuning gain	O	O	X
40	Position controller gain 1	-	-	O
41	Speed response 1	-	-	O
42	Speed controller integration time 1	-	-	O
45	Feed forward filter time constant	-	-	O
46	Torque filter time constant	-	-	O

* O : Parameter which must be set

- : Parameter which may not be set (The value is automatically calculated inside the amplifier and the result is reflected on the parameter.)

X : The parameter has no effect even if it is set.

- Position controller gain 1 (Parameter 40)* This parameter determines the response of the position control loop. A larger setting improves the response to the load disturbance, while a too large setting is likely to generate overshoot
- Speed response 1 (Parameter 41)* This parameter determines the response of the speed control loop. A larger setting improves the response of the servomotor, while too large a setting may cause the mechanical system to vibrate
- Speed controller integration time 1 (Parameter 42)* This parameter determines the response of the speed control loop. A smaller setting improves the response of the servomotor, while too small a setting may cause the mechanical system to vibrate
- Feed forward filter time constant (Parameter 45)* This parameter sets the feed forward filter for the position command and the tracking capability to the position command. The parameter is always valid regardless of the feed forward gain setting. A smaller setting improves the response but likely to cause torque shock
- Torque filter time constant (Parameter 46)* This parameter filters the torque command.
A larger setting suppresses resonance of the machine while stability in the control may be undermined

Parameter #43



Parameter #43

No.	Name	Setting range	Initial value	Change
43	S-curve time constant	0.0 to 100.0 [msec] (in 0.1 increments)	2.0	Always

* It is valid for position control and speed control.

The servomotor can be accelerated or decelerated moderately in the S-curve pattern.

If the pulse string input is given at a constant frequency, the servomotor accelerates or decelerates at the time constant of the set time.

Smooth acceleration and deceleration are obtained even if the host controller does not allow linear acceleration.

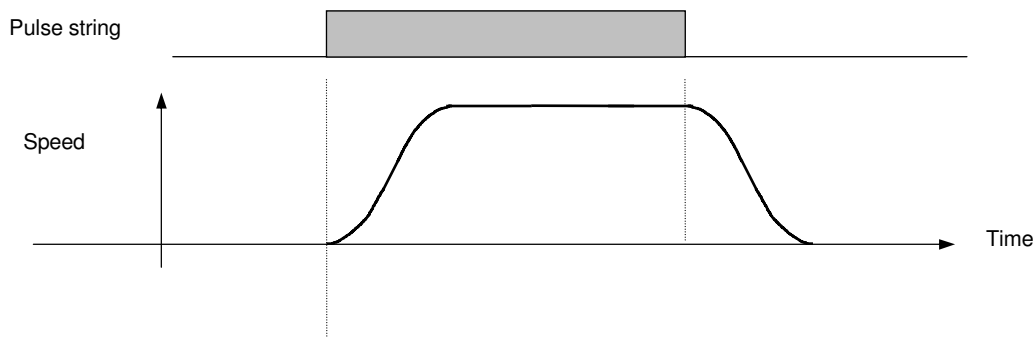

* Specify the parameter without fail if the dumping control function (parameters #60 through #63) are used.

Refer to section 7.1 “Vibration control.”

Parameter #44

Pn01 / no.44

Parameter #44

No.	Name	Setting range	Initial value
44	Feed forward gain	0.000 to 1.500 (in 0.001 increments)	0.000

* It is only valid for position control.

This parameter functions if parameter #60 (command following control selection) is set at “0 (none).” Specify the parameter in a poorly rigid machine or a mechanical system having a large load inertia ratio, to increase the response.

Specify a value between 0.100 and 0.500 to obtain a preferable result. A larger setting reduces position deviation (difference between position command and feedback position), resulting in a better response.

To perform synchronous operation between two axes, set “1.000.”

Parameter #47

Pn01 / no.47

Parameter #47

No.	Name	Setting range	Initial value
47	Speed setting filter	0.00 to 20.00 [msec] (in 0.01 increments)	0.00

* It is valid for position control and speed control.

Specify the parameter to filter the speed command.

* No change is necessary in principle.

Parameter #48 - #53



Parameters #48 through #53

No.	Name	Setting range	Initial value	Change
48	Gain switching factor	0: Position deviation (x 10), 1: Feedback speed, 2: Command speed	1	Always
49	Gain switching level	1 to 1000 (in 1 increments)	50	Always
50	Gain switching time constant	0 to 100 [msec] (in 1 increments)	10	Always
51	Position controller gain 2	30 to 200 % (in 1 increments)	100	Always
52	Speed response 2	30 to 200 % (in 1 increments)	100	Always
53	Speed controller integration time 2	30 to 200 % (in 1 increments)	100	Always

* It is valid for position control and speed control.

Only No. 51 is valid for position control.

The gain at the time of stopping is switched from the first gain (parameters #40 to #42) to the second gain (parameters #51 to #53).

Gain switching reduces the noise and vibration at the time of stopping.

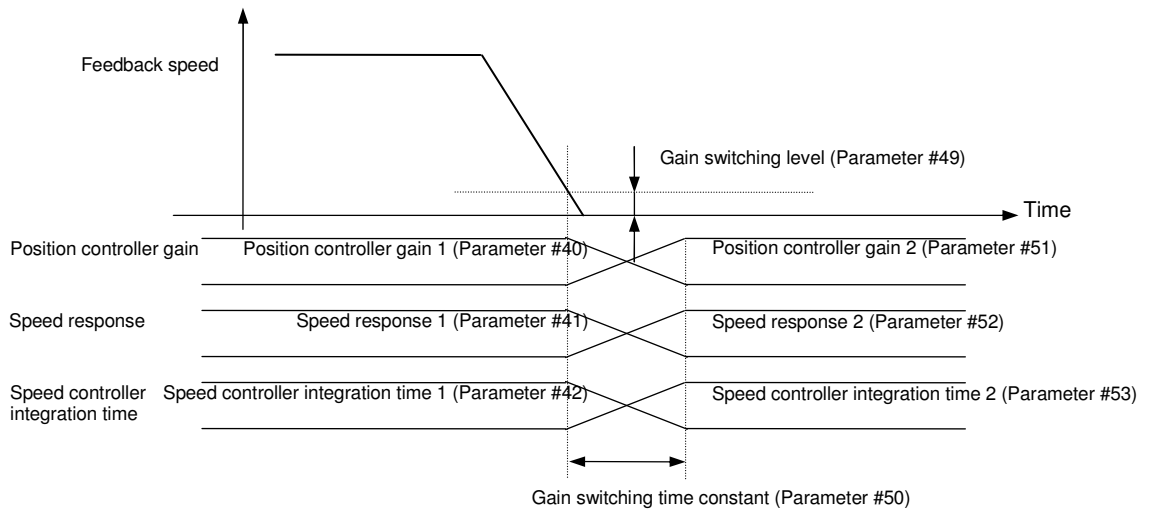

The settings of the second gain (parameters #51 to #53) are given in the ratio (%) to the first gain.

Example: When speed response 1 (parameter #41) is 100Hz

“100%” of speed response 2 (parameter #52) means 100Hz.

“80%” of speed response 2 (parameter #52) means 80Hz.

* The same rule applies to position controller gain 2 (parameter #51) and speed controller integration time 2 (parameter #53).

Parameter #54

Pn01 / no.54

Parameter #54

No.	Name	Setting range	Initial value	Change
54	Torque setting filter	0.000 - 9.999 [sec] (in 0.001 increments)	0.000	Always

* It is only valid for torque control.

With this parameter, the input voltage of the analog torque command input [Vref] terminal can be filtered.

Parameter #55

Pn01 / no.55

Parameter #55

No.	Name	Setting range	Initial value	Change
55	Command following control selection	0: None, 1: Command following control, 2: Command following control (with correction on stop)	0	Power

* It is only valid for position control.

Use the parameter to select the command following control mode where the mechanical system follows the command without delay to the pulse command.

 Refer to section 7.2 “Command following control.”

Parameter #56 - #59



Parameters #56 through #59

No.	Name	Setting range	Initial value	Change
56	Notch filter 1 frequency	10 to 200 [x 100 Hz] (in 1 increments)	200	Always
57	Notch filter 1 damping amount	0 to 40 [dB] (in 1 increments)	0	Always
58	Notch filter 2 frequency	10 to 200 [x 10Hz] (in 1 increments)	200	Always
59	Notch filter 2 damping amount	0 to 40 [dB] (in 1 increments)	0	Always

* It is valid for position control and speed control.

Specify to suppress resonance of the mechanical system.

Resonance can be suppressed at up to two points.

Notch filter setting method

i) Use the servo analysis function of the BSD Configurator (option) to determine the resonance point of the machine.

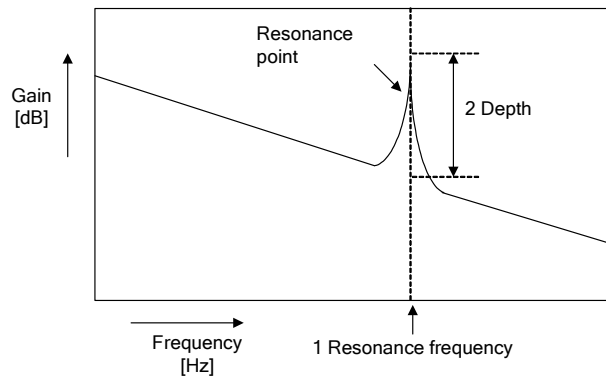

ii) Specify the resonance frequency and damping amount of the resonance point of the machine in parameters.

1 Resonance frequency → Parameter #56 (Notch filter 1 frequency)

2 Depth → Parameter #57 (Notch filter 1 damping amount)*

* Too deep a damping amount may undermine stability of the control. Avoid setting too large a value.

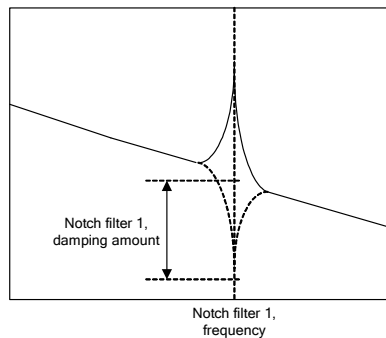

Use the servo analysis function again.

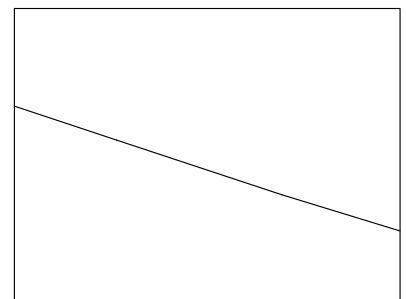
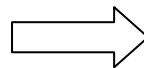

The resonance point is eliminated due to the notch filter.

The notch filter functions at the resonance point as shown in the figure above.

Parameter #60 - #63



Parameters #60 through #63

No.	Name	Setting range	Initial value	Change
60	Anti-resonance frequency 0	5.0 to 200.0 [Hz] (in 0.1 increments)	200.0	Always
61	Anti-resonance frequency 1	5.0 to 200.0 [Hz] (in 0.1 increments)	200.0	Always
62	Anti-resonance frequency 2	5.0 to 200.0 [Hz] (in 0.1 increments)	200.0	Always
63	Anti-resonance frequency 3	5.0 to 200.0 [Hz] (in 0.1 increments)	200.0	Always

* It is only valid for position control.

Use these parameters to specify anti-resonance frequencies and suppress vibration of the workpiece (vibration suppressing control).

The vibration suppressing control function becomes invalid with 200.0Hz (factory setting).

Refer to section 7.1 “Vibration suppressing control.”

Parameter #64 - #69



Parameters #64 through #69

No.	Name	Setting range	Initial value	Change
64 to 69	Not used	—	0	—

These parameters are not used.

Parameter #70 - #71

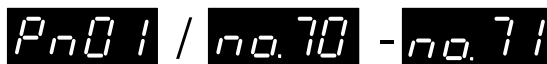

Parameters #70 and 71

No.	Name	Setting range	Initial value	Change
70	Analog command gain	$\pm 0.10 - \pm 1.50$ (in 0.01 increments)	1.0	Always
71	Analog command offset	-2000 - +2000	(Set before shipment)	Always

Gain and offset of the analog speed command input [Vref] can be adjusted.

Analog command gain The gain can be set in the range from ± 0.10 to ± 1.50 in increments of 0.01.

By adding the negative sign, the rotation direction will be reverse.

1) Speed control (speed command voltage)

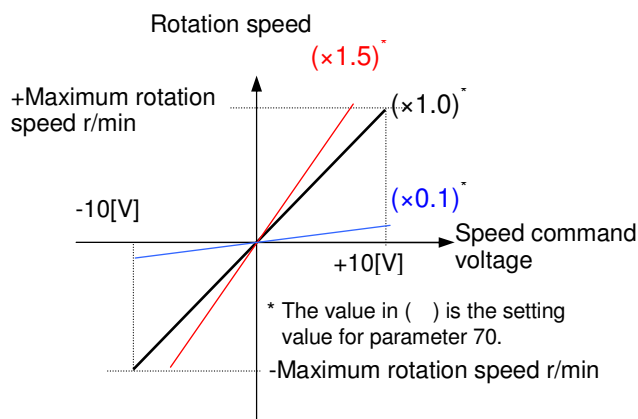

2) Torque control (torque command voltage)

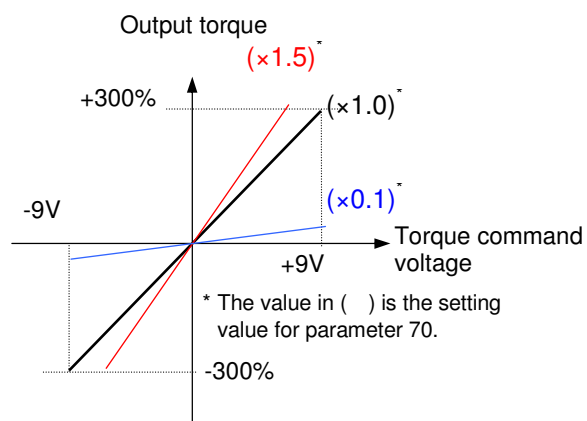

*) The relation between the speed command voltage and rotation speed by the analog command gain is as follows:

$$\text{Rotation speed [r/min]} = \text{Maximum rotation speed [r/min]} \times \text{Analog voltage} \times \text{Analog command gain}/10$$

*) The relation between the torque command voltage and the output torque by the analog command gain is as follows:

$$\text{Output torque [\%]} = 300 [\%] \times \text{Analog voltage} \times \text{Analog command gain}/9$$

*) The relationship between the speed command voltage and the rotation direction is shown below (upon shipment from factory).

Speed command voltage	Rotation command	Rotation direction	Rotation speed [r/min]
+6.0V	FWD	CCW	3000
	REV	CW	
+1.0V	FWD	CCW	500
	REV	CW	
0V	FWD	-	0
	REV	-	
-5.0V	FWD	CW	2500
	REV	CCW	

*) The relationship between the torque command voltage and the rotation direction is shown below (upon shipment from factory).

Torque command voltage	Rotation command	Rotation direction	Output torque
+6.0V	FWD	CCW	200%
	REV	CW	
+1.5V	FWD	CCW	50%
	REV	CW	
0V	FWD	-	0%
	REV	-	
-4.5V	FWD	CW	150%
	REV	CCW	

Analog command offset It is set in the range from -2000 to 2000 in increments of 1.

Increment [1] is equivalent to [0.68 mV].

The setting range is from [-1.36V] to [1.36V].

The reference value set at factory before shipment is registered as the initial value. Automatic offset adjustment is available in test operation mode of the keypad. **F_n07**

The value after adjustment is incorporated to parameter No. 70.

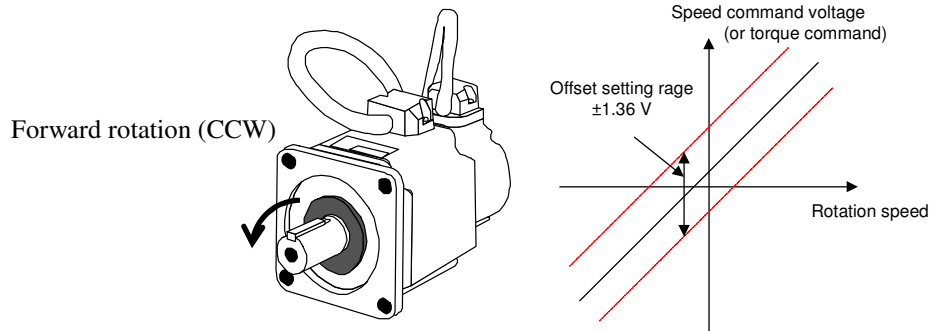

Resolution during speed control (speed command voltage)



14 bit resolution is available in full scale (-11.22 to +11.22 [V]). When the maximum rotation speed is 5000 [r/min] and 10V (speed command voltage), the resolution is (-5000 to +5000) [r/min]/214 × 11.22/10 = 0.67 [r/min]. (For BSM [0.1-0.75 KW] motor)

Resolution during torque control (torque command voltage)

14 bit resolution is available in full scale (-11.22 to +11.22 [V]). When the maximum torque is 300% and 9V (torque command voltage), the resolution is (-300 to +300) % /214 × 11.22/9 = 0.046%

(rated torque 100%)

Parameter #72



Parameter #72

No.	Name	Setting range	Initial value	Change
72	Operation sequence selection for dynamic brake unit connection	0: DB invalid for OT detection/RUN = DB invalid for OFF 1: DB valid for OT detection/RUN = DB invalid for OFF 2: DB invalid for OT detection/RUN = DB valid for OFF 3: DB valid for OT detection/RUN = DB valid for OFF	0	Power

It is set when the optional dynamic brake unit (soon to be released) is connected.

Parameter #73



Parameter #73

No.	Name	Setting range	Initial value	Change
73	Brake operation time	0.00 - 9.99 [sec] (in 0.01 increments) Base shutoff delay time at RUN = OFF	0.00	Always

Set the operation time of the external brake.

Set the time from the servo ON (RUN) signal OFF of the servo amplifier to the base OFF status.

For detailed timing chart, refer to “4.4 Brake timing”.

Parameter #74 - #77



Parameters #74 to 77

No.	Name	Setting range	Initial value
74	CONT normally ON 1	0 - 21 (in 1 increments)	0
75	CONT normally ON 2	0 - 21 (in 1 increments)	0
76	CONT normally ON 3	0 - 21 (in 1 increments)	0
77	CONT normally ON 4	0 - 21 (in 1 increments)	0

Any sequence input signal can always be ON.

Signals available for allocation are as follows:

1: Servo ON (RUN)

Operation command is normally ON.

11: Command pulse inhibition (INH)

Command pulse is normally inhibited.

This is set when only manual operation is performed during position control.

(It is not set for pulse string.)

15: Manual forward (FWD), 16: Manual reverse (REV)

They are normally ON during speed/torque control but are not normally ON during position control.

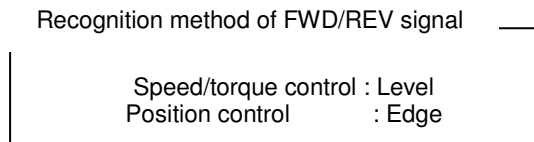

17: Multistep speed selection 1 (X1), 18: Multistep speed selection 2 (X2)

Specific multistep speed is ON.



When this parameter is allocated to either one of control parameters #74 to 77, it is normally ON. Signals that allow the status to be normally ON are 4.

Parameter #78 - #80

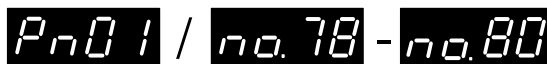

Parameters #78 to 80

No.	Name	Setting range	Initial value	Change
78	Command pulse compensation α1	1 - 32767 (in 1 increments)	1	Always
79	Command pulse compensation α2	1 - 32767 (in 1 increments)	1	Always
80	Command pulse compensation α3	1 - 32767 (in 1 increments)	1	Always

* It is only valid for position control.

With “Command pulse compensation α selection 0” and “Command pulse compensation α selection 1” allocated by the sequence signal, the value of the command pulse compensation α is changed.

Command pulse compensation α selection 1	Command pulse compensation α selection 0	Command pulse compensation α
OFF	OFF	Parameter #1
OFF	ON	Parameter #78
ON	OFF	Parameter #79
ON	ON	Parameter # 80

Parameter #81



Parameter #81

No.	Name	Setting range	Initial value	Change
81	Parameter storage in RAM	0: Not specified, 1 - 99 (in 1 increments)	0	Power

Parameter settings are stored in EEPROM (electronically rewritable EPROM) for data storage during power shutoff.

* The maximum assured count of rewriting in EEPROM is 100,000 times.

With storage of parameters in RAM, data can be infinitely rewritten.

Specify the number of RAM storage to parameter #81.

The initial value is set for the parameter stored in RAM when the power is supplied.

List of parameters storable in RAM

No.	Description of parameter	No.	Description of parameter
1	Command pulse compensation α	37	Acceleration time 2
2	Command pulse compensation β	38	Deceleration time 2
25	Maximum current limit value	60	Anti-resonance frequency 1
31	Manual feed speed 1	61	Anti-resonance frequency 2
32	Manual feed speed 2	62	Anti-resonance frequency 3
33	Manual feed speed 3	63	Anti-resonance frequency 4
34	Maximum rotation speed	78	Command pulse compensation α 1
35	Acceleration time 1	79	Command pulse compensation α 2
36	Deceleration time 1	80	Command pulse compensation α 3

Parameter #82 - #83



Parameters #82 and 83

No.	Name	Setting range	Initial value
82	Station No.	1 - 31 (in 1 increments)	1
83	Baud rate	0 : 38400 [bps] , 1 : 19200 [bps] , 2 : 9600 [bps]	0

- Station No.

The station number of the servo amplifier is specified from 1 to 31 with the RS485 communication cable.

- Baud rate

The baud rate is set with the RS485 communication cable.

Parameter #84 - #86

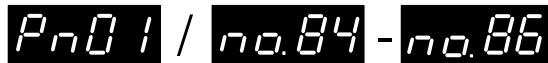

Parameters #84 to 86

No.	Name	Setting range	Initial value	Change
84	Easy tuning: Travel setting	0.5 - 200.0 [rev] (in 0.1 increments)	2.0	Always
85	Easy tuning: Speed setting	10.0 - Maximum rotation speed [r/min] (in 0.1 increments)	500.0	Always
86	Easy tuning: Timer setting	0.01 - 5.00 [sec] (in 0.01 increments)	0.50	Always

The parameters are set for Smart Tuning.

Refer to Chapter 6.

Parameter #87 - #92

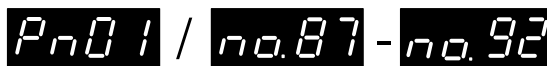

Parameters #87 to 92

No.	Name	Setting range	Initial value	Change
87	Monitor 1 signal allocation	1: Speed command, 2: Speed feedback, 3: Torque command, 4: Position deviation, 5: Position deviation (extension), 6: Pulse frequency	2	Always
88	Monitor 2 signal allocation	1: Speed command, 2: Speed feedback, 3: Torque command, 4: Position deviation, 5: Position deviation (extension), 6: Pulse frequency	3	Always
89	Monitor 1 scale	± 2.0 - ± 100.0 [V] (in 0.1 increments)	7.0	Always
90	Monitor 1 offset	- 50 - +50 (in 1 increments)	0	Always
91	Monitor 2 scale	± 2.0 - ± 100.0 [V] (in 0.1 increments)	6.0	Always
92	Monitor 2 offset	- 50 - +50 (in 1 increments)	0	Always

* ±11.0 [V] or more is not output for monitor output.

Monitor 1 or monitor 2 terminal output can be selected.

Output description of monitor 1 [MON1] and monitor 2 [MON2] terminals can be selected.

All output types are common for position control, speed control and torque control.

Monitor 1/monitor 2 signal allocation

Details output to monitor 1 [MON1] and monitor 2 [MON2] terminals are set

Parameters #87, 88/Monitor allocation

Output type	Details
1: Speed command	Speed command to the servomotor recognized by the servo amplifier.
2: Speed feedback	Actual rotation speed of the servomotor.
3: Torque command	Torque command to the servomotor recognized by the servo amplifier.
4: Position deviation	Difference (deviation) between position command and position feedback.
5: Position deviation (extension)	Difference (deviation) between position command and position feedback.
6: Pulse string frequency	Pulse string frequency input to the pulse string input terminal.

Monitor 1/monitor 2 scale

Full scale output to monitor 1 [MON1] and monitor 2 [MON2] terminals is set

#89, 91/Monitor scale

Output type	Monitor scale
1: Speed command	Output voltage for the maximum rotation speed.
2: Speed feedback	Output voltage for the maximum rotation speed.
3: Torque command	Output voltage for the maximum torque.
4: Position deviation	Output voltage for 8192 pulses.
5: Position deviation (extension)	Output voltage for 512 pulses.
6: Pulse string frequency	Output voltage for 1 MHz.

When negative sign is specified, polarity of the output voltage can be changed.

The settings to 100.0 [V] can be made, but voltage more than 11.0 [V] cannot be output.

Monitor 1/monitor 2 offset The offset voltage of monitor 1 [MON1] and monitor 2 [MON2] terminals can be adjusted.

The setting range is -50 - 0 - 50 in increments of 1. The setting value has no unit.

Monitor 1 output type (speed feedback) When the negative sign is specified by monitor 1 scale, polarity of the output voltage is reversed.

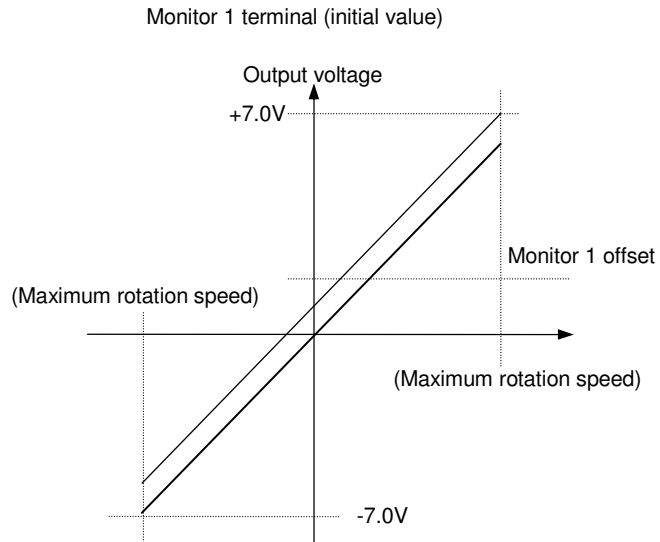

Resolution of monitor 1/monitor 2 output The resolution is 12 bit (4096) in full scale (-12.5 to +12.5).

The resolution is $(-12.5 \text{ to } +12.5) [V] / 2^{12} = 6.1 [mV]$.

* The maximum/minimum output is $\pm 11.0 [V]$ and the calculation of the resolution is $\pm 12.5 [V]$.

Parameter #93



Parameters #93

No.	Name	Setting range	Initial value	Change
93	Not used	—	0	—

These parameters are not used.

Parameter #94 - #97

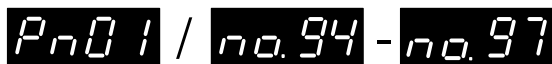

Parameters #94 to 97

No.	Name	Setting range	Initial value	Change
94	For adjustment by manufacturer	—	Adjusted value	—
95	For adjustment by manufacturer	—	Adjusted value	—
96	For adjustment by manufacturer	—	Adjusted value	—
97	For adjustment by manufacturer	—	Adjusted value	—

The parameters are for adjustment by manufacturer. Do not change them.

Parameter #98 - #99



Parameters #98 and 99

No.	Name	Setting range	Initial value	Change
98 to 99	Not used	—	0	—

These parameters are not used.

Chapter 6 – Adjustment of Servo

Adjustment procedures

The servomotor must be tuned so that it reliably obeys commands sent from the host controller.

Perform tuning with the procedures below:

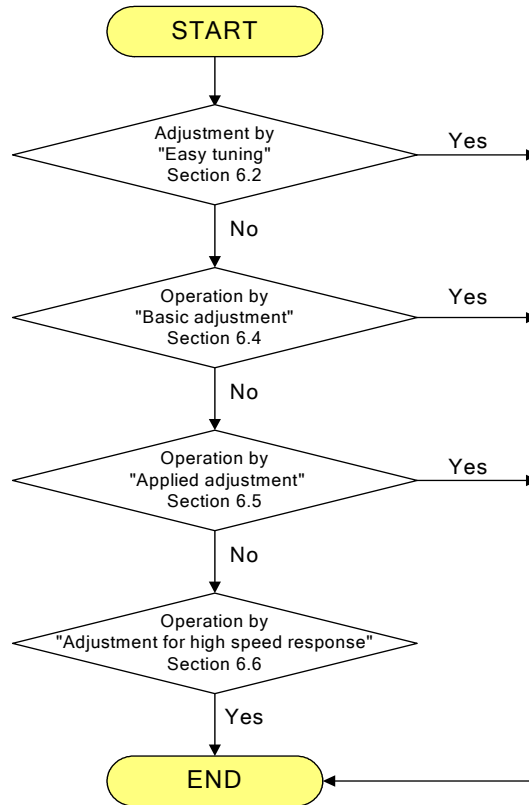

Smart Tuning

What is "Smart Tuning" If the system is not connected to the upper level control system, the system automatically reciprocates for automatic tuning.

Even when the program of the upper level control system is not completed, the motor can be operated in advance and tuning can also be performed. This contributes to a reduction of the setup time.

<Only the amplifier and the motor allow reciprocation and tuning.>

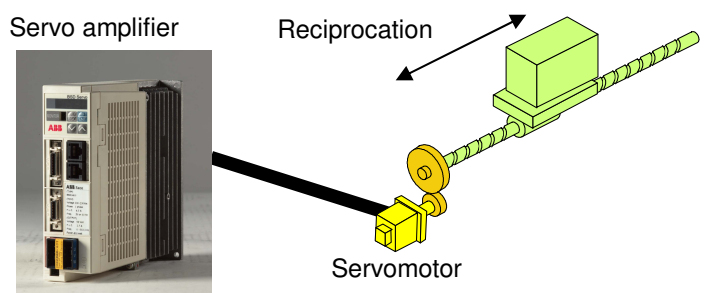

Operation pattern of Smart Tuning Smart Tuning has 2 operation patterns, which can be operated with keypad/BSD Configurator.

- 1) Slow run One reciprocal movement at 10 r/min (fixed). Rotation direction and travel are checked.
- 2) Smart Tuning 25 reciprocal movements. During this time, automatic tuning is performed.

After checking rotating directing and travel with "slow run," perform "Smart Tuning."

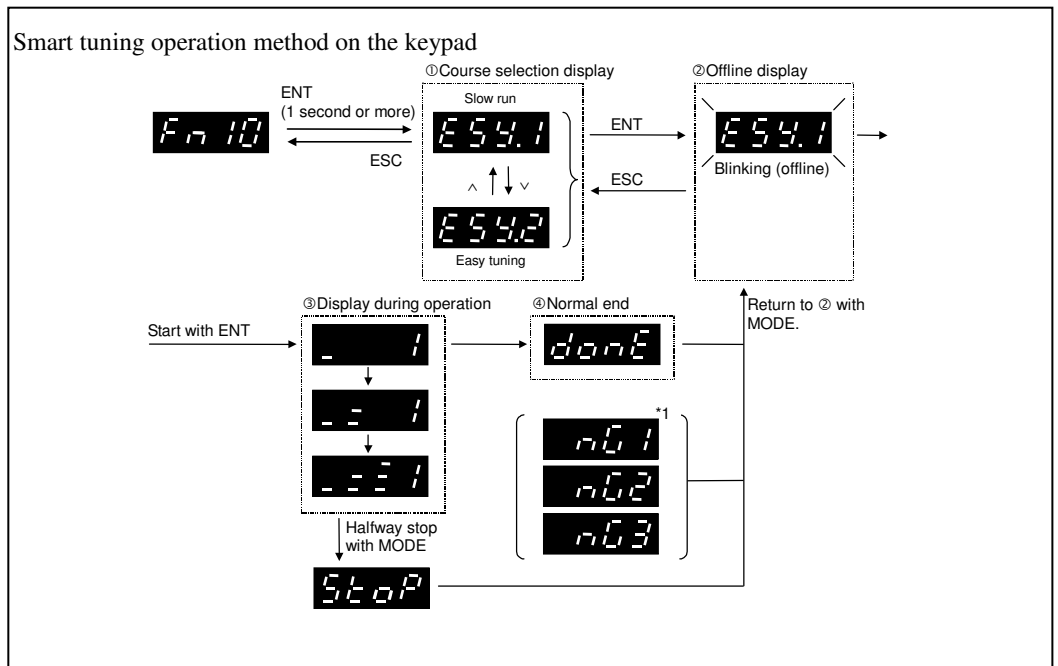
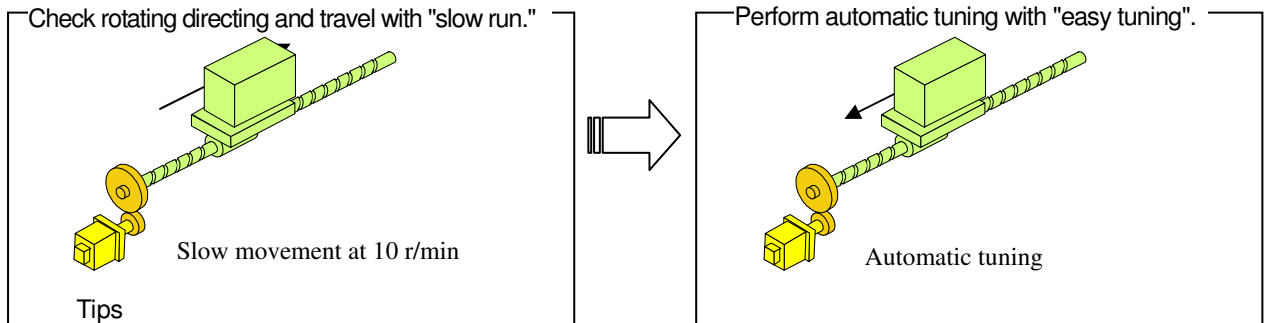

Cautions for Smart Tuning During Smart Tuning, the system is automatically operated with the function of the servo amplifier. Be careful as to safety.

If the motor oscillates and an adverse effect on the machine is expected, allocate the servo ON (RUN) signal or the emergency stop (EMG) signal to the CONT signal. Perform Smart Tuning with these signals ON. If an error occurs during operation, turn OFF any of the signals immediately.

If the machine may be damaged due to overtravel, allocate \pm overtravel signal (\pm OT) to the CONT signal and provide the overtravel sensors at both ends of the movable travel before Smart Tuning.

Description of operation Two operation patterns of Smart Tuning are described

(1) *Slow run* <Start conditions>

Conditions to start slow run are shown below. Required conditions are marked with "O" If the conditions below are not satisfied, the system cannot be started. ("NG1" is displayed.)

Power supply to main circuit	Not alarm status	Not ±OT or EMG status	BX signal is OFF	Auto tuning status ^{*1}	Auto gain reference value at start	Parameter rewritable ^{*2}
○	○	○	○	○	*3	○

*1) When parameter No. 5 (tuning mode) is 0 (auto tuning) (The system cannot be started with other settings.)

*2) When parameter No. 29 (parameter write protected) is 0 (rewritable)

*3) When parameter No. 7 (auto tuning gain) is 4 or less, the system automatically starts from 5. When the parameter is 16 or more, it starts from 15.

<Operation pattern>

The operation pattern is as follows. "POO" in the table means the parameter number

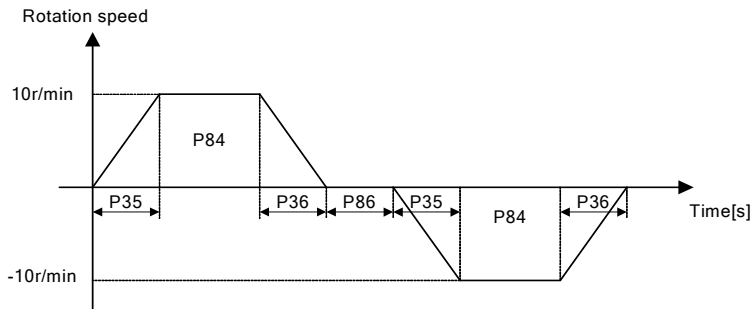

Travel distance	No. of operations	Acceleration time	Deceleration time	Rotation speed	Timer	Rotating direction *	
						Forward	Return
P84	1 reciprocal movement	P35	P36	10r/min	P86	CCW	CW

* When P4 (rotating direction switching) is 0

<Description of tuning>

Tuning is not basically performed during slow run.

If the machine has a tendency to resonate, the auto tuning gain (hereinafter referred to as auto gain) is automatically reduced. At this time, the notch filter (page 56 to page 59) is automatically adjusted.

<Description of operation end>

There are 3 patterns for operation end; normal end, halfway stop (only performed by operator) and NG end. Each case is described.

Normal end	Halfway stop by stop operation	NG end	
		Error occurrence	Occurrence of machine resonance when auto gain is 4 or less
If machine resonance occurs, the notch filter is automatically adjusted and the auto gain is automatically reduced.	Returns to auto gain at the start of operation.	Returns to auto gain at the start of operation.	Automatically changes to auto gain that stops resonance.

(2) Smart Tuning <Start conditions>

Conditions to start Smart Tuning are shown below. Required conditions are marked with "○" If the conditions below are not satisfied, the system cannot be started. ("NG1" is displayed.)

Power supply to main circuit	Not alarm status	Not ±OT or EMG status	BX signal is OFF.	Auto tuning status ^{*1}	Auto gain reference value at start	Parameter rewritable ^{*2}
○	○	○	○	○	*3	○

*1) When parameter No. 5 (tuning mode) is 0 (auto tuning) (The system cannot be started with other settings.)

*2) When parameter No. 29 (parameter write protected) is 0 (rewritable)

*3) When parameter No. 7 (auto tuning gain) is 4 or less, the system automatically starts from 5. When the parameter is 16 or more, it starts from 15.

Tips If the machine has any of the following problems, easy tuning may not function properly.

- Machine with low rigidity and high tendency to vibrate
- Machine with large backlash
- Machine with large viscous friction
- Machine that can only move in one direction (no reciprocal movement)
- Machine with very low rotation speed (Ex.: 100 r/min or less)
- Machine with large load inertia ratio (BSM [0.1-0.75 kW] motor: 30 times or more, BSM [1.0-2.0 kW] motor: 5 times or more)
- Machine with large fluctuations of load inertia

<Operation pattern>

The operation pattern is as follows. "POO" in the table means the parameter number.

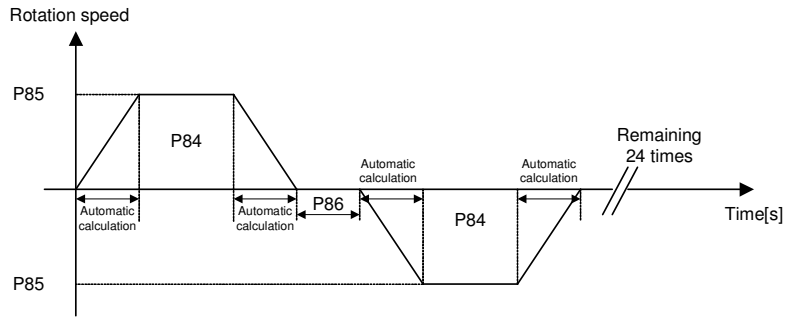

Travel distance	No. of operations	Acceleration time	Deceleration time	Rotation speed	Timer	Rotating direction ^{*1}	
						Forward	Return
P84	25 reciprocal movements	Automatic calculation ^{*2}	Automatic calculation ^{*2}	P85	P86	CCW	CW

*1) When P4 (rotation direction switching) is 0

*2) The automatically calculated value can be checked with the BSD Configurator.

<Description of tuning>

During Smart Tuning, 25 reciprocal movements are performed. During this operation, automatic tuning (auto gain in the range from 5 to 15) is performed.

<Description of operation end>

There are 3 patterns for operation end; normal end, halfway stop (only performed by the operator) and NG end. Each case is described

Normal end	Halfway stop by stop operation	NG end	
		Error occurrence	Machine resonance occurs even when auto gain is 4 or less
Auto gain (range from 5 to 15) is automatically and finally adjusted.	Returns to auto gain at start of operation.	Returns to auto gain at start of operation.	Automatically changes to auto gain that stops resonance.

Factor of NG display Factors when NG is displayed during Smart Tuning are described (common for each mode)

<Cause of NG1 display>

- (1) Parameter No. 29 (parameter write protect) is "1: Write protect."
- (2) ±OT, EMG or external regenerative resistor overheating is detected.
- (3) Parameter No. 5 (tuning mode) is not "0: Auto tuning."
- (4) Power is not supplied to the main circuit.

<Cause of NG2 display>

- (1) ±OT, EMG or external regenerative resistor overheating is detected halfway. (Coasting signal is ignored.)
- (2) RUN signal is turned OFF. (RUN: Started with ON.)

<Cause of NG3>

- (1) Auto tuning gain is 4 or less and the motor is oscillating.

Pattern operation

What is pattern operation?

If the system is not connected to the upper level control system, the system automatically performs reciprocation for automatic tuning. The operation continues until the system is stopped by an operator. This operation is used to confirm the effective torque (keypad: On13). (Tuning is not performed during pattern operation.)

Tip Pattern operation method with keypad

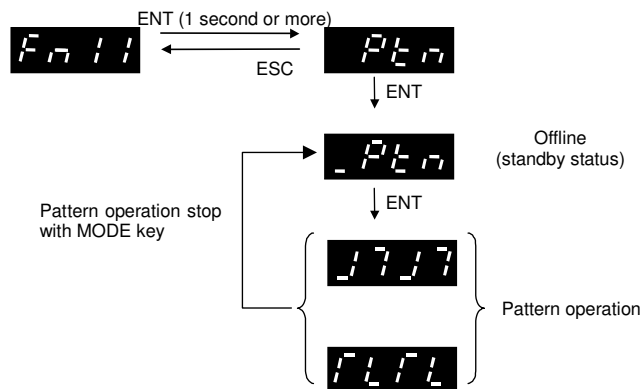

Description of operation <Start conditions>

Conditions to start pattern operation are shown below. Required conditions are marked with "O". If the conditions below are not satisfied, the system cannot be started. ("NG1" is displayed.)

Power supply to main circuit	Not alarm status	BX signal is OFF.	Not ±OT or EMG status
○	○	○	○

<Operation pattern>

The operation pattern is as follows. "POO" in the table means the parameter number.

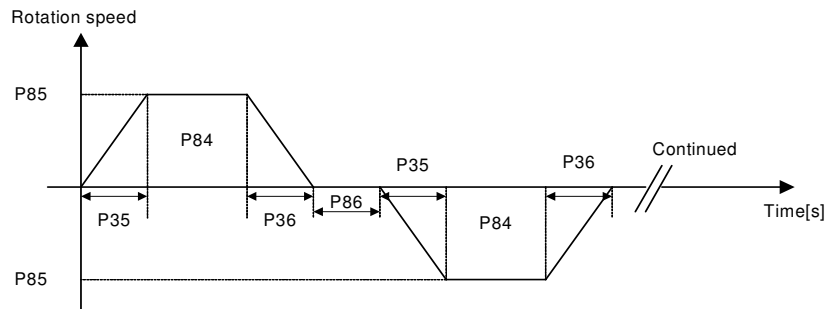

Travel distance	No. of operations	Acceleration time	Deceleration time	Rotation speed	Timer	Rotating direction *	
						Forward	Return
P84	Continued	P35	P36	P85	P86	CCW	CW

*1) When P4 (rotation direction switching) is 0

<Description of tuning>

During pattern operation, tuning is not performed

<Stop method of pattern operation>

The method to stop pattern operation is stoppage of the system by an operator or occurrence of an error*.

* Occurrence of an error means ① Detection of ±OT, EMG or external regenerative resistor overheating halfway, ② Detection of BX (coasting signal) ON halfway and ③ RUN signal OFF halfway.

Basic adjustment

The tuning method includes three types: auto tuning, semi-auto tuning and manual tuning (parameter #5).

Be sure to operate the servomotor in the auto tuning mode (factory setting) for the first time when operating it.

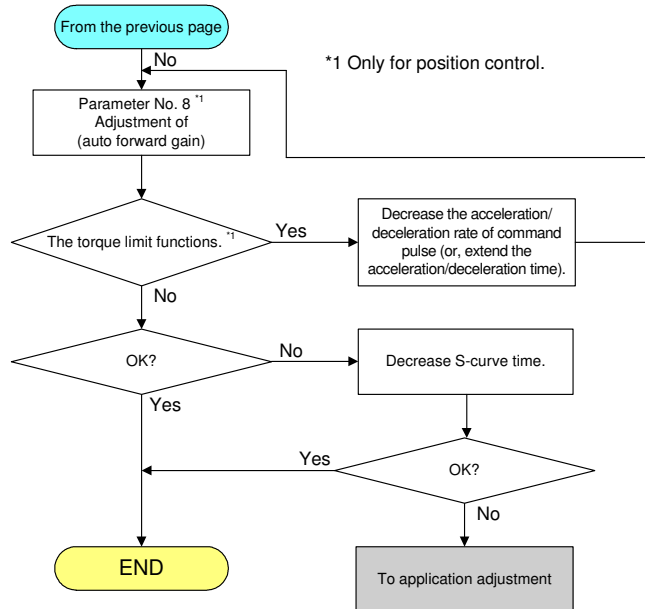
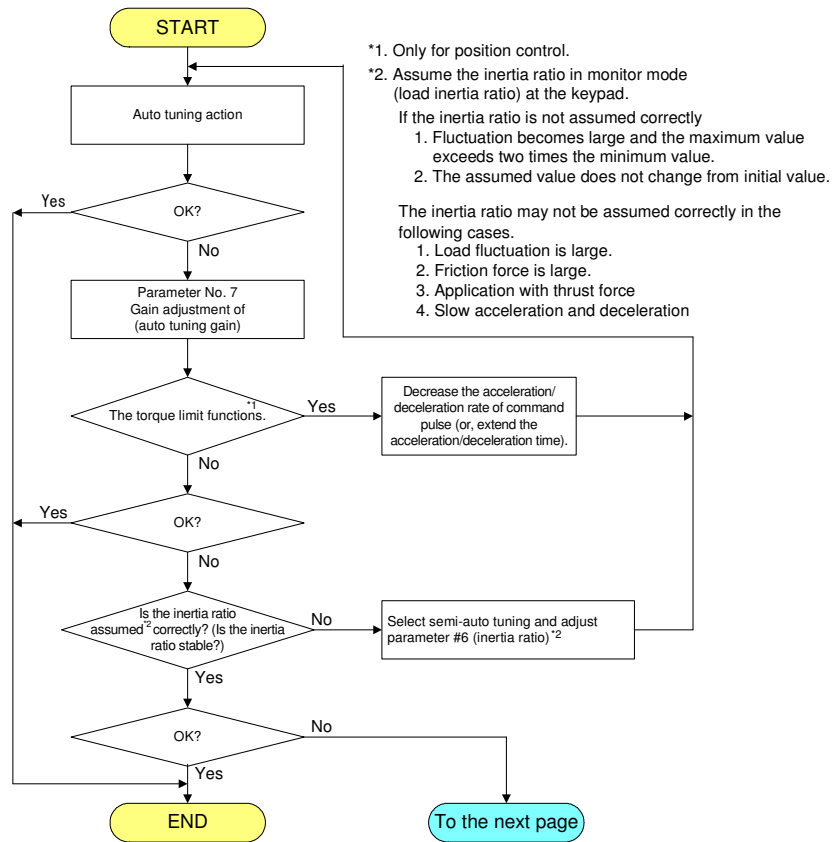



Set the zero deviation width (parameter No. 21) referring to the description below:

Ex.) When precision of ±10 μm is desired on a machine with ball screw fastening and 10 mm lead.

$$\frac{131072[\text{pulse/rev}]}{10 \times 10^{-3} [\text{m}]} \times (10 \times 10^{-6} [\text{m}]) = 131.072 \approx 131 [\text{pulse}]$$

$$\frac{131072[\text{pulse/rev}]}{\text{Movement per rotation [m]}} \times (\text{Required precision [m]}) = \text{Zero deviation width [pulse]}$$

Set "131" for zero deviation width (parameter No. 21)

Parameters automatically adjusted in the auto or semi-auto tuning mode

No.	Name	Tuning mode	
		0: Auto	1: Semi-auto
06	Load inertia ratio	- (Updated every 10 minutes)	O(*1)
07	Auto tuning gain	O	O
40	Position controller gain 1	- (Always updated)	- (Fixed)
41	Speed response 1	- (Always updated)	- (Fixed)
42	Speed controller integration time 1	- (Always updated)	- (Fixed)
45	Feed forward filter time constant	- (Always updated)	- (Fixed)
46	Torque filter time constant	- (Always updated)	- (Fixed)

*1) This parameter is automatically set when "Auto" is changed to "Semi-auto."

O : Item specified manually.

- : Item specified automatically.

- Parameters automatically updated in the auto tuning mode are updated at real time.

- In the semi-auto tuning mode, automatically updated parameters are fixed once they are set*.

* Parameters are automatically set when parameter #6 (load inertia ratio) or parameter #7 (auto tuning gain) is changed.

Approximate measure for auto tuning gain (parameter #7) setting

A larger auto tuning gain reduces the response time while vibration is likely to be generated.

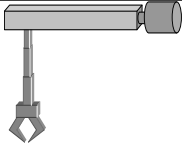
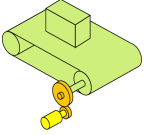
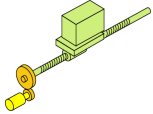
Mechanical configuration	Auto tuning gain (Approximate measure)
Large transportation machine	1 to 6
 Arm robot	5 to 10
 Belt drive	7 to 13
 Ball screw mechanism	10 to 15
Inserting, mounting or bonding machine	13 to 20

Application adjustment

Use this adjustment method when adjustment is not satisfactory after the procedure described in section 6.4 “Basic adjustment” or if the servomotor vibrates and the auto tuning gain (parameter #7) cannot be increased sufficiently.

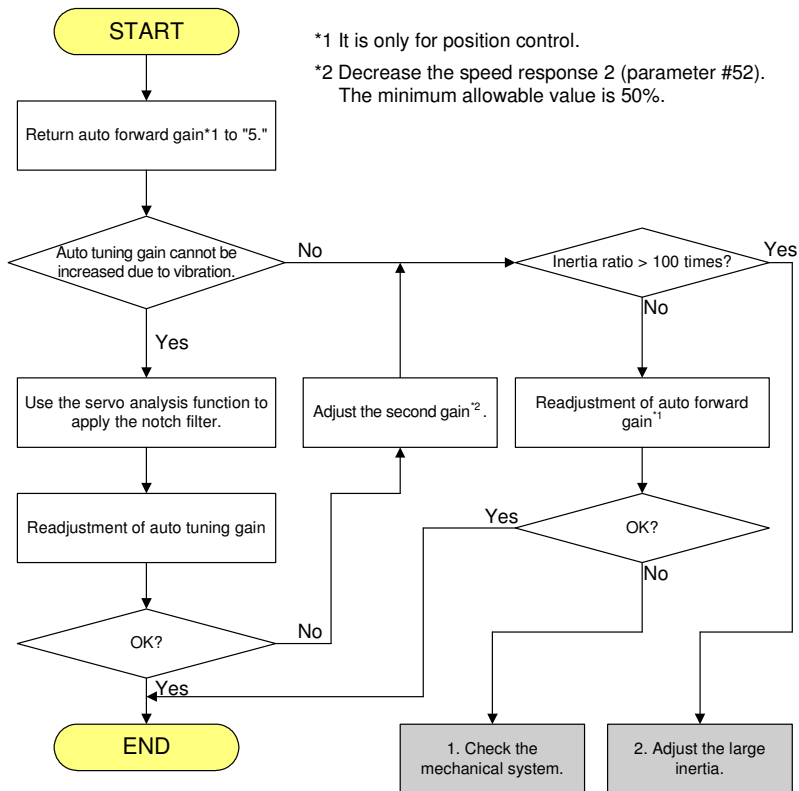

1. Check the mechanical system

Check the mechanical system for the following problems.

- i) Large backlash
- ii) Deflection of belt

2. Adjust the large inertia

Note) In principle, the load inertia ratio should be used at BSM (0.1-0.75 KW): 100 times or less and BSM (1.0-2.0 KW): 30 times or less.

How to check if the load inertia ratio exceeds 100 times (or 30 times)^{*1}

- i) Use capacity selection software to automatically calculate the load inertia.
- ii) Use monitor mode 09 (load inertia ratio) at the Keypad to assume.

(The displayed value is up to 99 (30) times^{*1}. If “80 (20)”^{*1} or a larger value is displayed, the ratio may be larger than 100 (30) times^{*1}.)

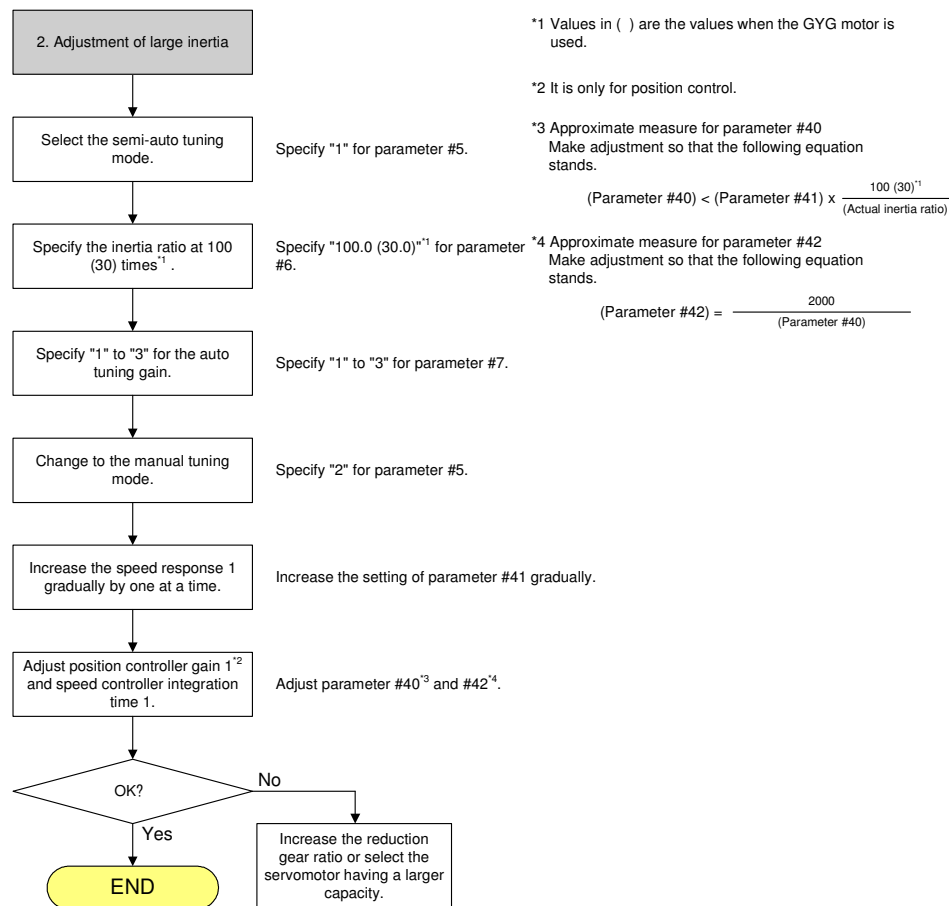

How to set the notch filter (parameters #56 through #59)

i) Use the servo analysis function of the optional BSD Configurator to locate the resonance point of the machine.

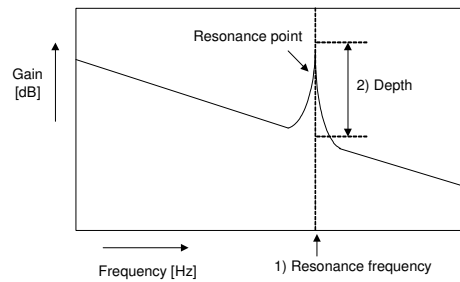

ii) Set the resonance frequency and damping amount at the resonance point of the machine in parameters.

1) Resonance frequency → Parameter #56 (Notch filter 1 frequency)

2) Depth → Parameter #57 (Notch filter 1 damping amount)*

* If the damping amount is too large, stability of the control system may be undermined. Avoid specifying too large a value.

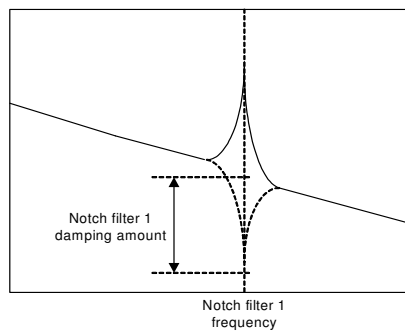

Activate the servo analysis function again.

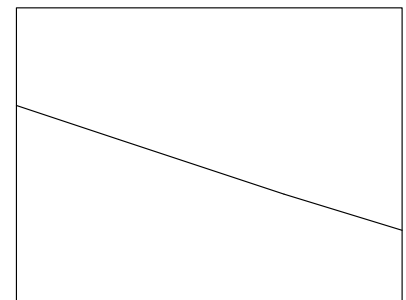
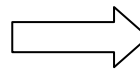

The notch filter functions to offset the resonance point.

The notch filter is applied at the resonance point as shown in the figure above.

Adjustment requiring high speed response

Use this method to obtain quicker response than that obtained after adjustment specified in section 6.5 “Application adjustment.” (However, do not use the method described here if “adjustment of large inertia” has been made.)

While measuring the operation time and output timing of the positioning end signal by using historical trace of the BSD Configurator, make adjustment as follows.

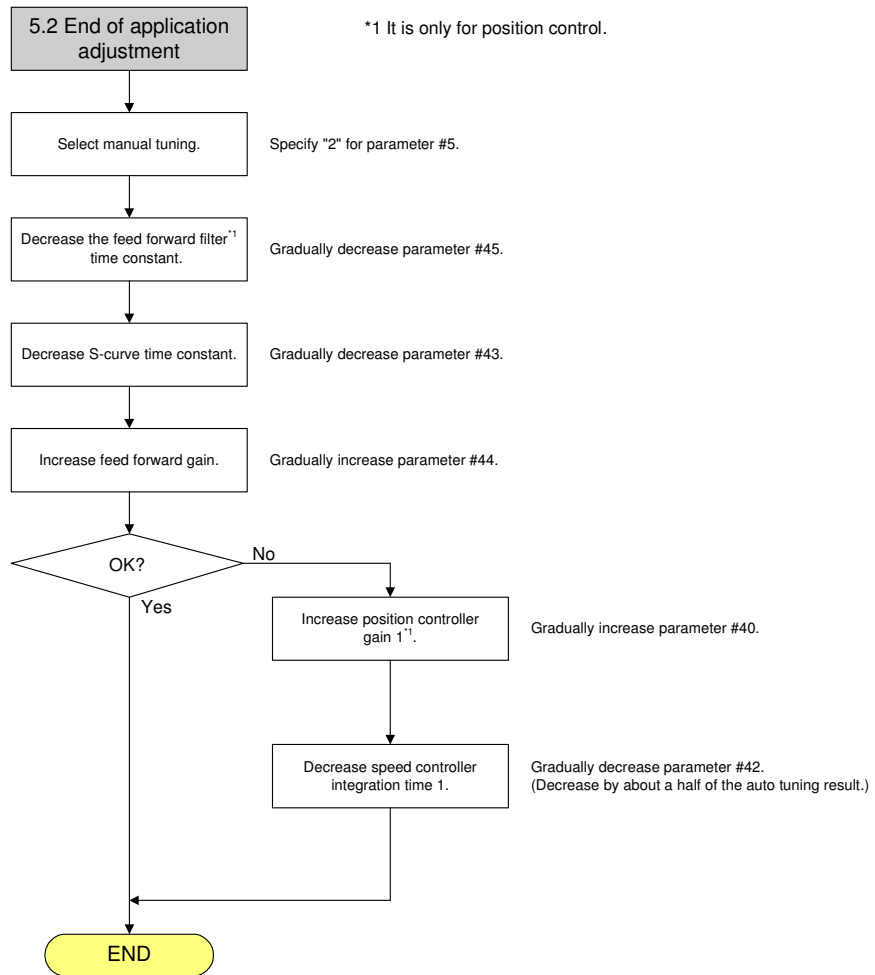

- Note 1: Adjust the gain so as not to generate mechanical vibration or torque fluctuation.
- Note 2: If the machine rigidity is low, vibration can be minimized by gradually increasing S-curve time constant (parameter No. 43).

**Overshoot adjustment
(only for position control)**

This is the procedure applied when adjustment is performed while observing waveform on a BSD Configurator and the following overshoot is detected on the waveform of motor's actual operation.

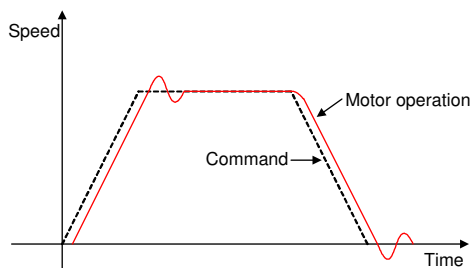

If overshoot is displayed as above, confirm the following:

1. Does torque limitation work?

→ Make necessary adjustments so that the value may be less than the torque limit.

- ① Lower acceleration/deceleration rate.
- ② Lower load moment of inertia.
- ③ Raise deceleration ratio or capacity.

2. Isn't the setting of load-to-inertia ratio (parameter No.6) too small?

→ Confirm the load-to-inertia ratio.

- ① Confirm it on the keypad monitor.
- ② Calculate it automatically by our company's capacity selection software.

3. Isn't "position controller gain 1 (parameter No.40)" greater than "speed response 1 (parameter No.41)" ?

→ Adjust parameters so that "position controller gain 1 (parameter No.40)" is greater than or equal to "speed response 1 (standard parameter No.41)"

4. Isn't the setting of feed forward gain (parameter No.44) too high?

→ Lower feed forward gain a little bit at a time.

5. Isn't the setting of speed controller integration time 1 (parameter No.42) too low?

→ Raise speed controller integration time 1 a little bit at time.

6. Isn't the setting of S-curve time (parameter No.43) too low?

→ Raise S-curve time a little bit at a time.

Adjustment for shortening stabilization time (only for position control)

This is the adjustment procedure applied when adjustment is performed while observing waveform on a BSD Configurator and the waveform of the motor's actual operation is as if leaving traces like below.

In the case of under-run:

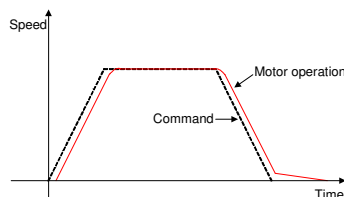

- ① Lower S-curve time (parameter No.43).
- ② Increase auto forward gain (parameter No. 8).^{*1}
- ③ Raise feed forward gain (parameter No.44).
- ④ Lower load-to-inertia ratio (parameter No.6).^{*2}

(Apply a value within $\pm 10\%$ to the change volume as a measure.)

In the case of over-run:

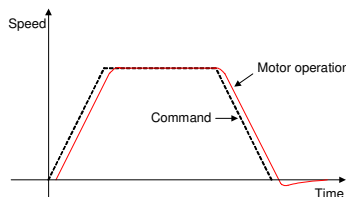

- ① Raise S-curve time (parameter No.43).
- ② Decrease auto forward gain (parameter No. 8).^{*1}
- ③ Lower feed forward gain (parameter No.44).
- ④ Raise load-to-inertia ratio (parameter No.6).^{*2}

(Apply a value within $\pm 10\%$ to the change volume as a measure.)

*1) This is not valid when the tuning method is manual.

*2) This is not valid when the tuning method is auto (valid for semi-auto).

Standard values for adjustment parameters

The parameters for adjusting servo gain have the following standard values

No.	Name	Standard value
40	Position controller gain 1	Position controller gain 1 (parameter No.40) \leq Speed response 1
41	Speed response 1	Speed response 1 (parameter No.41) $\leq \frac{500}{1+\text{Load-to-inertia ratio (parameter No.6)}}$
42	Speed controller integration time 1	Speed controller integration time 1 (parameter No.42) $= \frac{2000}{\text{Speed response 1 (parameter No.41)}}$
45	Feed forward filter time constant	Feed forward filter time constant (parameter No.45) $= \frac{1000}{\text{Position controller gain 1 (parameter No.40)}}$
46	Torque filter time constant	0.2 \leq Torque filter time constant (parameter No.46) \leq 1.0

Chapter 7 – Special Adjustments

Vibration suppressing control

What is vibration suppressing control?

(1) Purpose of vibration suppressing control

In the spring structure of a robot arm or a transfer unit, a part end vibrates when the motor is suddenly accelerated or decelerated. The vibration suppressing control function prevents vibration of parts in such a system and performs positioning with high tact

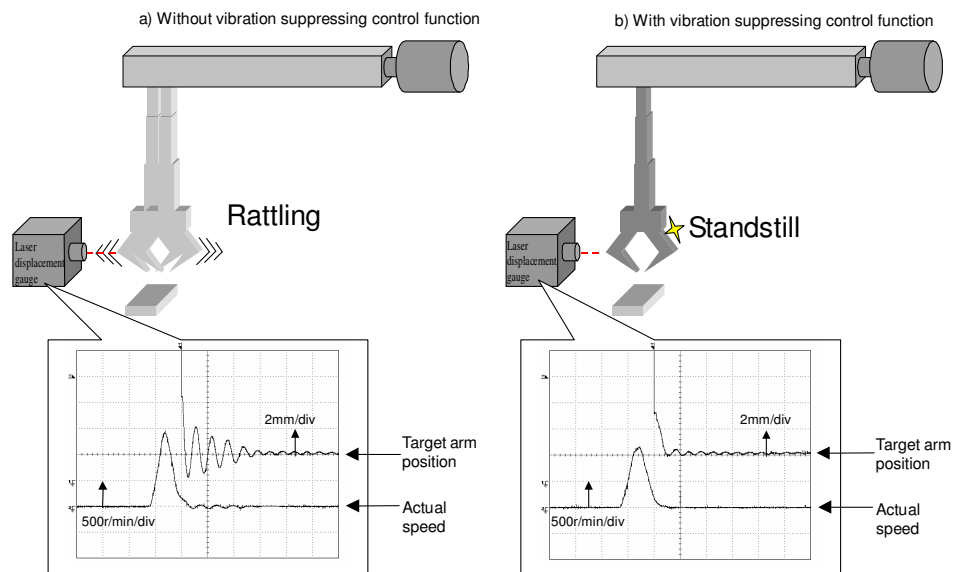

Not only vibration of parts is reduced, but also vibration of the overall unit is reduced

- Without vibration suppressing control unit

The maximum torque is generated when the motor is accelerated/decelerated. The entire machine may vibrate due to impact during acceleration/deceleration.

- With vibration suppressing control unit

Torque during acceleration/deceleration of the motor is controlled. Impact during acceleration/deceleration is reduced and vibration of the entire machine may be controlled even on a machine with a relatively weak rigidity.

(2) Principle of vibration suppressing control

The amplifier incorporates a machine mode land controls dumping so that the vibration at the assumed workpiece position of the model is eliminated. The controlled variable thus obtained is added to the position and speed of the motor as an offset to suppress vibration at the actual workpiece position

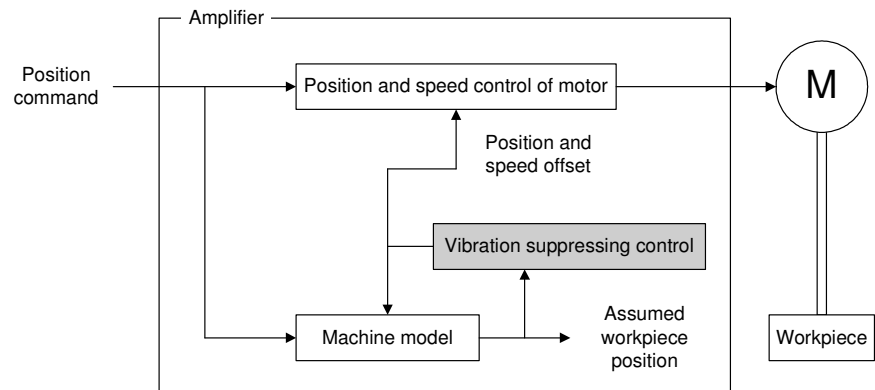

(3) Machine characteristics and conditions valid for vibration suppressing control

Applicable machine characteristics and conditions

- Vibration occurs at the end of the arm due to shocks during travel and stop of robot arm or the like.
- The machine itself vibrates due to the shock caused by movement or stopping of a part of the machine.
- Vibration frequency is between 5 and 100Hz.

Non-applicable machine characteristics and conditions

- Vibration generates continuously without relations to movement or stopping.
- Vibration synchronized to the rotation of the motor or machine generates.
- The vibration frequency is smaller than 5Hz or larger than 100Hz.
- The moving time is within the vibration period.
- There is backlash in mechanical connections located up to the vibrating mechanism.
- (Command pulse compensation α / Command pulse compensation β) > 50
- Command pulse string frequency ≤ 20 kHz

Parameter setting method

Adjustment flow chart

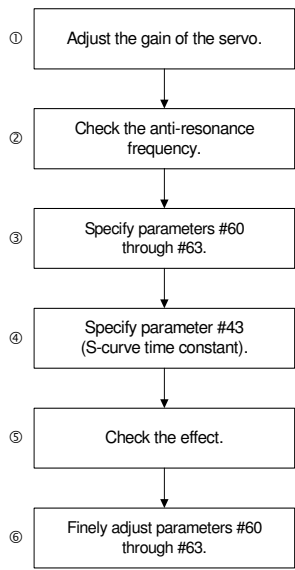

① *Adjust the gain of the servo*

To achieve smooth a stop (elimination of overshoot, etc.) with the servomotor while ignoring vibration at end of the machine, adjust the servo gain according to the adjustment procedure in chapter 6.



Note

- If parameters related to the gain are adjusted after specifying the anti-resonance frequency, the anti-resonance frequency must be specified again.
- Be sure that the gain must be adjusted first.

② Check the anti-resonance frequency.

<When BSD Configurator is used>

Use the servo analysis function to check the anti-resonance point.

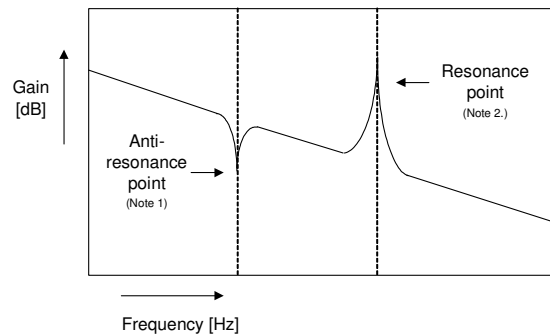

Note 1: The servo analysis function may fail to detect the anti-resonance point in the following machine configuration.

- ① Machines with much friction
- ② Reduction gear, ball screw mechanism and other machines having relatively large mechanical losses

Note 2: Use the notch filter for the resonance point.

Resonance point and anti-resonance point

There are resonance point and anti-resonance point for the vibration of the machine.

The “resonance point” and “anti-resonance point” are machine characteristics viewed from the motor.

- “Resonance point”: The end of the arm does not vibrate but the motor vibrates at the frequency.
- “Anti-resonance point”: The motor shaft does not vibrate but the end of the arm vibrates at the frequency.

Generally speaking the anti-resonance frequency is smaller than the resonance frequency

<When BSD Configurator is not used>

There are two checking methods.

If vibration frequency can be measured using a laser displacement gauge or the like, follow checking method i). In other cases, follow checking method ii).

- i) Measure vibration of the end of the arm directly using a laser displacement gauge or the like

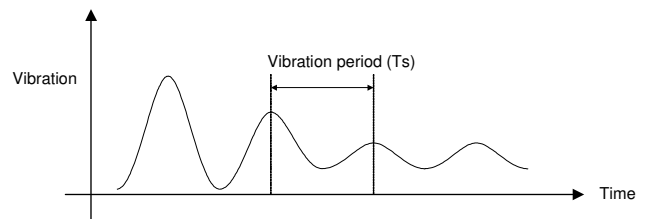

$$\text{Anti-resonance frequency} = \frac{1}{T_s} \quad [\text{Hz}]$$

- ii) While reducing the settings of parameters #60 through #63 gradually from 200.0Hz (maximum value), visually check vibration to find the best value

③ *Setting parameters #60 through #63* Specify the anti-resonance frequency obtained in step 2, to any of parameters #60 through #63*.

No.	Name	Setting range	Initial value	Change
60	Anti-resonance frequency 0	5.0 to 200.0 [Hz] (in 0.1 increments)	200.0	Always
61	Anti-resonance frequency 1	5.0 to 200.0 [Hz] (in 0.1 increments)	200.0	Always
62	Anti-resonance frequency 2	5.0 to 200.0 [Hz] (in 0.1 increments)	200.0	Always
63	Anti-resonance frequency 3	5.0 to 200.0 [Hz] (in 0.1 increments)	200.0	Always

* Up to four points can be specified

With ON/OFF combination of “Anti-resonance frequency selection 0” and “Anti-resonance frequency selection 1” of CONT input signal, setting for 4 points is allowed.

The anti-resonance point may vary according to the arm length and the weight of the load.

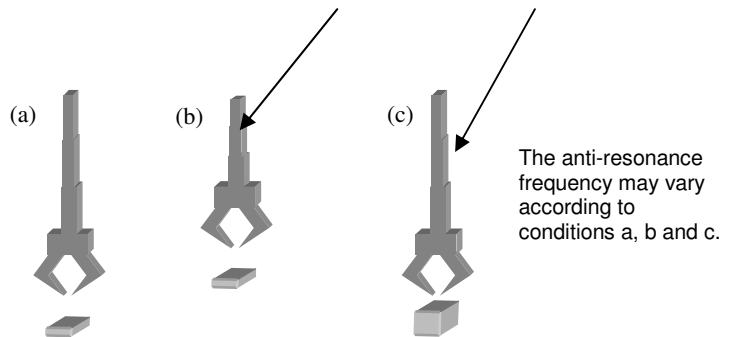

In this case, allocate this function to the CONT input signal and change the setting of the anti-resonance frequency for operation

Anti-resonance frequency selection 1	Anti-resonance frequency selection 0	Anti-resonance frequency
OFF	OFF	Parameter #60*
OFF	ON	Parameter #61
ON	OFF	Parameter #62
ON	ON	Parameter #63

* These signals are assumed to be inactive at any time if they are not assigned to the sequence input signals.

In this case, parameter #60 (anti-resonance frequency 0) is always valid.

To make anti-resonance frequency invalid, set the anti-resonance frequency at 200.0Hz.

Change the setting during stoppage because otherwise shocks may generate

④ *Specify parameter #43 (S-curve time constant)* To achieve the effect of dumping control, specify parameter #43 (S-curve time constant).

The approximate measure of the setting is as follows.

No.	Name	Setting range	Initial value	Change
43	S-curve time constant	0.0 to 100.0 [msec] (in 0.1 increments)	0.0	Always

Parameters #60 through #63 (Anti-resonance frequency)	Parameter #43 (S-curve time constant) (Approximate measure)	
	$1 \leq \alpha\beta' \leq 8$	$8 < \alpha\beta' \leq 50$
< 10 Hz	10 msec	20 msec
10 Hz to 20 Hz	5 msec	10 msec
> 20 Hz	2 or 3 msec	5 msec

$$* \frac{\alpha}{\beta} = \frac{\text{Command pulse compensation } \alpha \text{ (parameter \#1)}}{\text{Command pulse compensation } \beta \text{ (parameter \#2)}}$$

⑤ *Check the effect* There are three checking methods.

- i) Check the vibration of the end of the arm using a laser displacement gauge or a similar measuring instrument.
- ii) Take the high-speed motion picture of the end of the arm to check for vibration.
- iii) Visually check.



The anti-resonance frequency is not reflected on the servo analysis function even if one is set

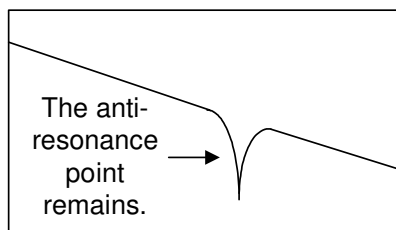

⑥ *Finely adjust parameters #60 through #63* While checking the effect of dumping control, finely adjust the setting (approximate measure: in 0.1 or 0.2 increments)

Command following control

What is command following control?

In the command following control mode, movement follows the command pulse string completely with almost zero position deviation

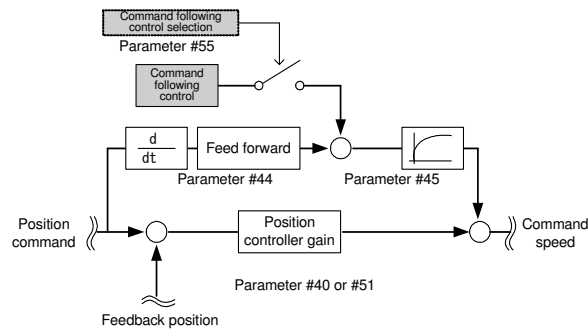
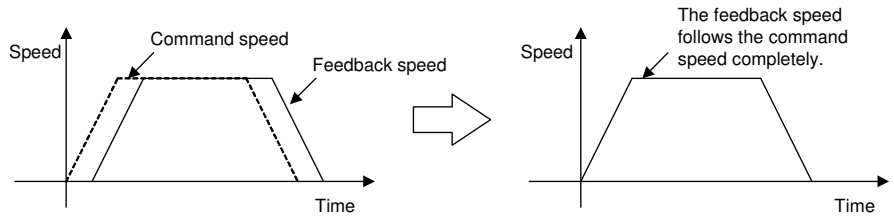

Mechanical system realizing command following control

Use “command following control” for the mechanical system satisfying all the following conditions.

- (1) Highly rigid machine
- (2) Pulse commands sent from the host controller are linear or in an S-curve to assure smooth acceleration and deceleration.
- (3) The pulse frequency updating period of the host controller is within several milliseconds.
- (4) Load inertia ratio (parameter #6) ≤ 10.0

As a guideline, set the parameters to suit the following conditions.

- (5) Position controller gain 1 (parameter #40) \times S-curve time constant (parameter #43) ≤ 1000.0

$$(6) \quad \frac{\text{Command pulse compensation } \alpha \text{ (parameter \#1)}}{\text{Command pulse compensation } \beta \text{ (parameter \#2)}} \leq 30$$

If command following control is used for a system not satisfying all of the above conditions, mechanical vibration may generate.

Parameter setting method

Nb.	Name	Setting range	Initial value	Change
55	Command following control selection	0: None, 1: Command following control, 2: Command following control (with correction on stop)	0	Power

The command following control includes two variations: with no correction on stop (setting: 1) and with correction on stop (setting: 2).

Position deviation generates in both methods when the acceleration changes (at ①, ②, ③, and ④).

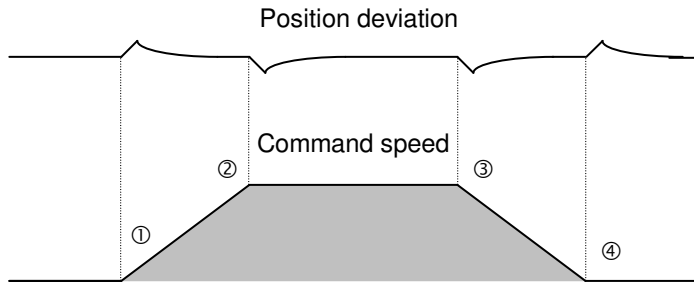

In case “with correction on stop (setting: 2),” position deviation caused by the acceleration change when the mechanical system is stopped is smaller.

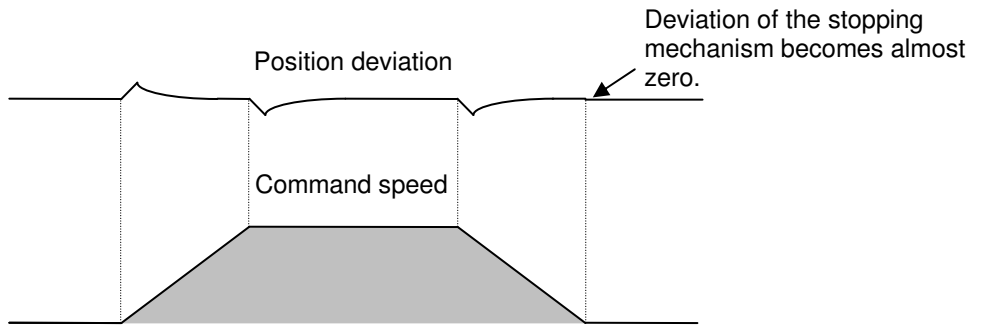

Select “no correction on stop (setting: 1)” for operation patterns where changes from forward to reverse rotation continue

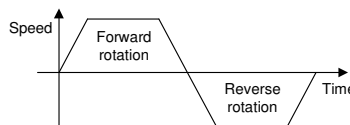

* In the command following control mode, specify “10” or a larger value for the auto tuning gain (parameter #7)

Display

The servo amplifier is provided with a Keypad.



It has a display section of four 7-segment LED digits and four operation keys.

Figures and letters are displayed on the display section (See the left figure.)

*The Keypad cannot be removed.

Mode The Keypad operation can be classified into four modes:

1. Sequence monitor mode: Indicates the servo amplifier status.
2. Monitor mode: Monitors the servomotor speed and the input/output signal status.
3. Parameter edit mode: Edits the parameter setting.
4. Test running mode: Operates the servomotor with the keypad operation.

List of 7-segment indications:

0	1	2	3	4	5	6	7	8	9	-
A	b	C	d	E	F	G	H	I	J	L
n	O	o	P	r	S	t	U, V	u, v	y	

Operation key



Changes the mode (MODE).
Cancels the selected mode (ESC).



Shifts to the less significant digit (SHIFT).
Stores the mode and figure (ENT).
Press more than 1 sec to store the data.



Selects the sub-mode.
Decreases the figure (-1).



Selects the sub-mode.
Increases the figure (+1).







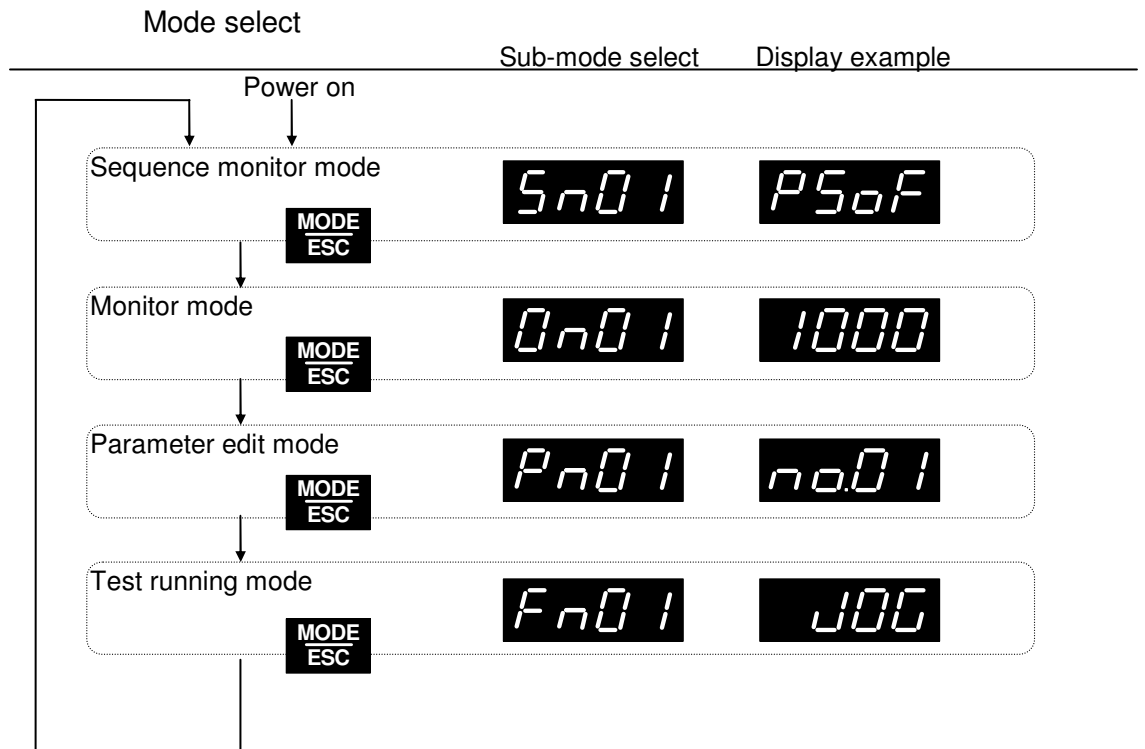































When this key is pressed, the upper 4 digits are replaced with the lower 4 digits.































Mode select Each mode can be selected by the [MODE] key



Function list

In parameter edit mode and positioning data edit mode, the reference values can be changed

Mode	Sub-mode	Sub-mode select	Display and setting example
Sequence monitor mode	Sequence mode		
	Current alarm		
	Alarm history		
	Station No. display		
Monitor mode	Feedback speed		
	Command speed		
	Average torque		
	Current feedback speed		
	Current command speed		
	Position deviation		
	Feedback cumulative pulse		
	Command cumulative pulse		
	Peak torque		
	Input voltage		
	Input/output signal		
	Load inertia ratio		
	OL thermal value		
	Regenerative resistor thermal value		

Mode	Sub-mode	Sub-mode select	Display and setting example
Monitor mode	Pulse string input frequency		
	DC link voltage (maximum value)		
	DC link voltage (minimum value)		
Parameter editing mode	Parameter editing		
Test running mode	Manual feed		
	Position reset		
	Cumulative pulse clear		
	Alarm reset		
	Alarm history initialization		
	Parameter initialization		
	Auto offset adjustment		
	Phase-Z position adjustment		
	Auto tuning gain		
	Smart Tuning		
	Pattern operation		

Sequence monitor mode

In the sequence monitor mode, the servo amplifier’s current status and the alarm detection history can be displayed.

Press the “MODE” key to display [*Sn0n*] and then press the “ENT” key for more than 1 sec.

- Sn01* : Sequence mode
- Sn02* : Current alarm
- Sn03* : Alarm history
- Sn04* : Station display

(1) Sequence mode

Output signal status and operation status of the servo amplifier are displayed.

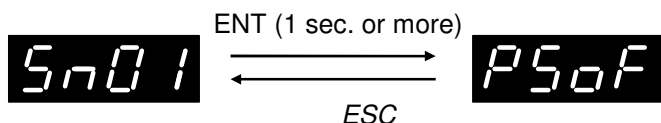

Indication	Control mode	Name	Description
<i>P50F</i>	Position control	Servo OFF	Base OFF status. The servomotor does not have drive force. It is in coasting state. (See Figure above.)
<i>P50n</i>		Servo ON	The servomotor is ready for rotation.
<i>PPIn</i>		Pulse string operation	The servomotor can rotate and pulse string inputs are valid.
<i>PJ0G</i>		Manual operation	The servomotor is ready for rotation and is rotating by manual feed.
<i>PPot</i>		+OT	The amplifier has detected an overtravel signal in positive direction and stops.
<i>Pnot</i>		-OT	The amplifier has detected an overtravel signal in negative direction and stops.
<i>Pn0</i>		Zero speed stop	The amplifier has received a forced stop signal and stops with the speed zero.
<i>PLu</i>		In LV	This is displayed when undervoltage is detected.
<i>n50F</i>	Speed control	Servo OFF	In base-off condition. The servomotor does not have driving force and is coasting to stop.
<i>n50n</i>		Servo ON	The servomotor is ready for rotation.
<i>nJ0G</i>		Manual operation	The servomotor is ready for rotation and is rotating by manual feed.
<i>nPot</i>		+OT	The amplifier has detected an overtravel signal in positive direction and stops.
<i>nnot</i>		-OT	The amplifier has detected an overtravel signal in negative direction and stops.
<i>nn0</i>		Zero speed stop	The amplifier has received a forced stop signal and stops with the speed zero.
<i>nLu</i>	In LV	This is displayed when undervoltage is detected.	
<i>t50F</i>	Torque control	Servo OFF	In base-off condition. The servomotor does not have driving force and is coasting to stop.
<i>t50n</i>		Servo ON	The servomotor is ready for rotation.
<i>tJ0G</i>		Manual operation	The servomotor is ready for rotation and is rotating by manual feed.
<i>tLu</i>		In LV	This is displayed when undervoltage is detected.



When the power is supplied to the servo amplifier, sequence of the sequence monitor mode is displayed.

The type of indication at power on can be changed by system parameter 30 setting.

Setting	Initial display	
0		Sequence mode
1		Current alarm
2		Alarm history
3		Station display

Setting	Initial display	
4		Feedback speed
5		Command speed
6		Average torque
7		Current feedback speed
8		Current command speed
9		Position deviation
10		Feedback cumulative pulse
11		Command cumulative pulse
12		Peak torque
13		Input voltage
14		Input/output signal
15		Load inertia ratio
16		OL thermal value
17		Regenerative resistor thermal value
18		Pulse string input frequency
19		DC link voltage (maximum value)
20		DC link voltage (minimum value)

Chapter 8 – Keypad

(2) Current Alarm

The contents of current alarm can be displayed with codes.

* The code is blinking during alarm detection. When the alarm is reset, the display becomes **---**.

The history can be displayed by [**Sn03**].

When an alarm is detected, the following indication will appear automatically.

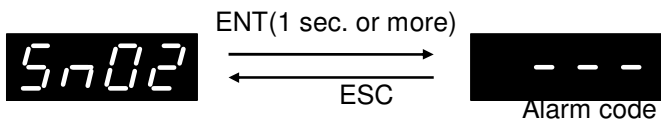

Priority	Indication	Description
1	OC1	Overcurrent 1
2	OC2	Overcurrent 2
3	OS	Overspeed
4	HV	Overvoltage
5	Et	Encoder trouble
6	Ct	Control power alarm
7	dE	Memory alarm
8	rH2	Regenerative transistor overheat
9	EC	Encoder communication alarm
10	Cnt	CONT duplication
11	OL	Overload
12	LV	Undervoltage

Priority	Indication	Description
13	rH1	Regenerative resistor overheat
14	DF	Deviation limit
15	AH	Amplifier overheat



The alarm codes are indicated automatically.

When an alarm is detected, the blinking occurs faster (intervals of 0.5 sec.) than normal (intervals of 1 sec.).

The reset of alarm detection can be carried out in the test operation mode.

Press the ^ and v keys simultaneously for one second or more while alarm detection is indicated to reset the alarm detection.

When the alarm is reset, the display becomes **---**.

Chapter 8 – Keypad

(3) Alarm history

The latest nine times of alarm detection history can be indicated. The indication can be scrolled by the \wedge and \vee keys.

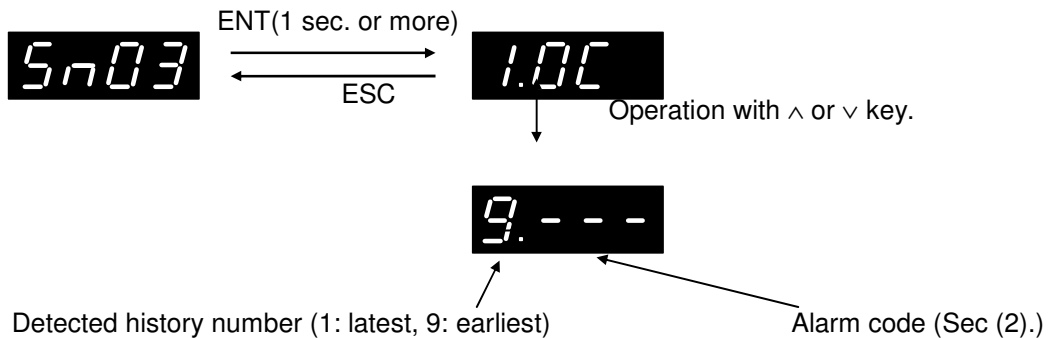

The alarm history can be deleted in the test operation mode [*Fn05*].

(4) Station display

The station number set for the servo amplifier is displayed.

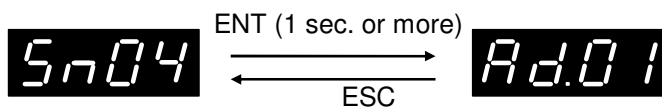

Monitor mode

In monitor mode, the rotation speed of the servomotor and the input pulse cumulative value are displayed. Press the MODE key to display [0n0n] and press the ENT key (for 1 sec or more) to display the content.

0n01 : Feedback speed	0n08 : Command cumulative pulse	0n15 : Pulse string input frequency
0n02 : Command speed	0n09 : Peak torque	0n16 : DC link voltage (maximum value)
0n03 : Average torque	0n10 : Input voltage	0n17 : DC link voltage (minimum value)
0n04 : Current feedback speed	0n11 : Input/output signal	
0n05 : Current command speed	0n12 : Load inertia ratio	
0n06 : Position deviation	0n13 : OL thermal value	
0n07 : Feedback cumulative pulse	0n14 : Regenerative resistor thermal value	

(1) Feedback speedNo. of displayed digits: 4 digits with sign

The servomotor's current speed. Even if the servomotor is driven by the load (mechanical system), the correct speed will be indicated. The display is increments of 1 [r/min] and the negative sign is given for reverse rotation (clockwise when viewed from the motor shaft).

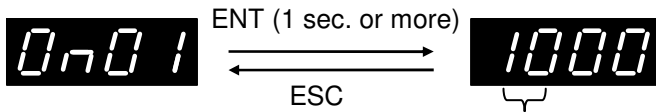

* During reverse rotation, the first digit ("1" for the example above) and "-" are displayed alternately.



(2) Command speedNo. of displayed digits: 4 digits with sign

It is the speed command to current servomotor. The command speed includes speed command voltage, multistep speed and pulse string, etc. The display is in increments of 1 [r/min] and the negative sign is given for reverse rotation (clockwise when viewed from the motor shaft).

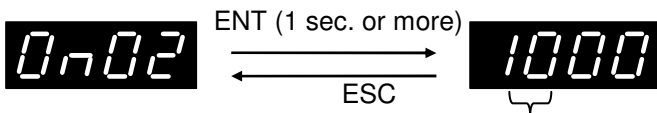

* During reverse rotation, the first digit ("1" for the example above) and "-" are displayed alternately.



Chapter 8 – Keypad

(3) Average torque..... No. of displayed digits: 3 digits with sign

Average torque value of which the command is given from the servo amplifier to the servomotor. The rated torque is displayed as 100%. The display range is from 0% to the (maximum torque) in increments of 1%. When the average torque is negative, a negative sign is added to the first digit.

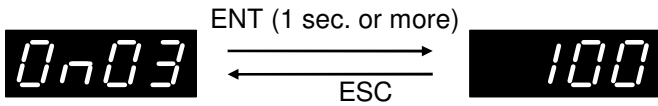

(4) Current feedback position No. of displayed digits: 8 digits with sign

Rotation of the servomotor is displayed. The display is the rotation of the motor shaft encoder. (The 17 bit serial encoder has 131072 pulses/rotation.)

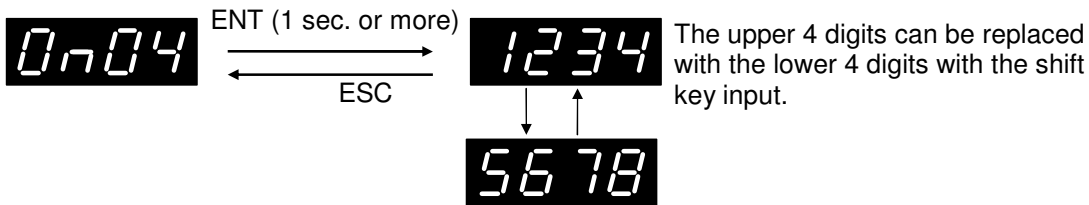

<Display of 8 digits with

On display, the upper 4 digits can be replaced with the lower 4 digits and the negative sign is displayed. The leftmost digit of the upper 4 digits is displayed in the order of "Value," "Sign (negative sign only)" and "H (or L) *."

* H indicates the upper 4 digits and L indicates the lower 4 digits.

■ Display example of upper 4 digits

■ Display example of lower 4 digits

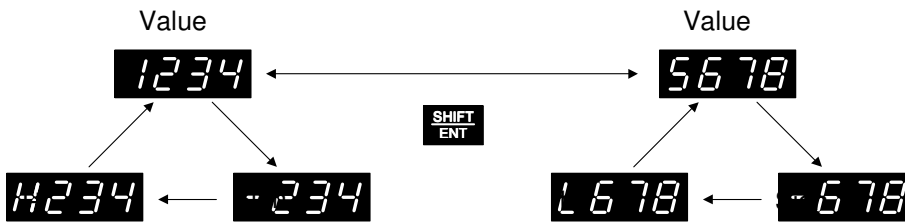

When the rotation direction is switched with parameter No. 4, the display value increases in the increase direction of the current position.

After the maximum positive value of 99,999,999, counting is started increasing from 0 again.

After the maximum negative value of -99,999,999, counting is started decreased from 0 again.

Chapter 8 – Keypad

(5) Current command positionNo. of displayed digits: 8 digits with sign

The position of the servomotor controlled by the servo amplifier is displayed. (The pulse compensation is not considered.)

When the system reaches the target position and the value is transferred from load (machine) after turning OFF the operation command, the correct position is not displayed. For display, refer to "(4) Current feedback position."

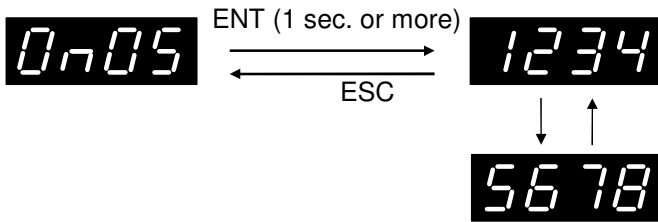

The upper 4 digits can be replaced with the lower 4 digits with the shift key input.

(6) Position deviationNo. of displayed digits: 8 digits with sign

Difference between the command position and the feedback position is displayed. The deviation is the conversion value to the pulse of the encoder.

For display, refer to "(4) Current feedback position."

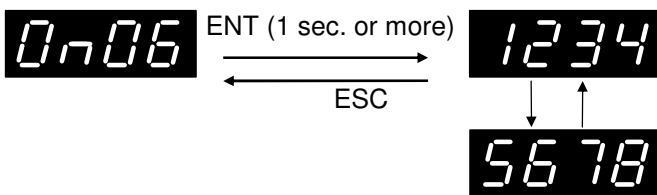

The upper 4 digits can be replaced with the lower 4 digits with the shift key input.

(7) Feedback cumulative pulseNo. of displayed digits: 8 digits with sign

The rotation cumulative pulse of the servomotor can be displayed with the encoder pulse (1 rotation: 131072 pulses). Rotation in the reverse direction decreases the cumulative value. Even when the value is transferred from load (machine), the correct value is displayed. For display, refer to "(4) Current feedback position."

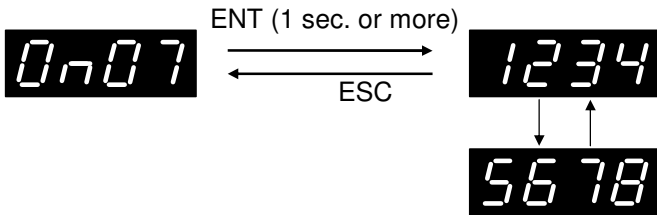

The upper 4 digits can be replaced with the lower 4 digits with the shift key input.



When the ^ key is pressed for 1 second or more and released, the feedback cumulative pulse can be cleared.

Chapter 8 – Keypad

(8) Command cumulative pulse..... No. of displayed digits: 8 digits with sign

The number of pulse strings input to the pulse string input terminal is displayed. With forward rotation pulse input, the cumulative value is increased. With reverse rotation pulse input, the cumulative value is decreased. Each edge is counted as a 90 degree phase difference 2 signal (multiplication of 4). The count value is increased with B phase advance.

For display, refer to "(4) Current feedback position."

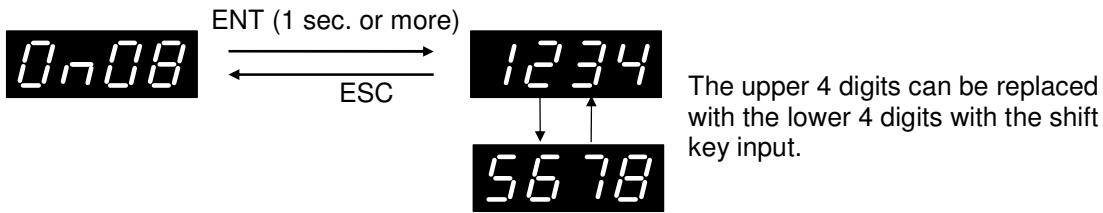

Hint When the ^ key is pressed for 1 second or more and released, the feedback cumulative pulse can be cleared.

(9) Peak torque..... No. of displayed digits: 3 digits with sign

It is the peak torque value of the servomotor every 2 seconds. The rated torque is displayed as 100%. The value is displayed in the range from 0% to the (maximum torque) in increments of 1%. When the torque command is negative, the negative sign is given to the first digit.

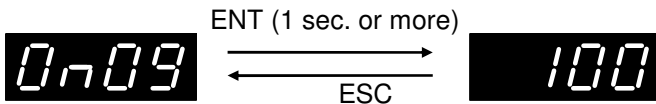

(10) Input voltage..... No. of displayed digits: 3 digits with sign

Input voltage of the analog input terminal [Vref] is displayed in increments of 0.1V. Negative sign indicates a negative (-) voltage.

The display range is -12.0V to 12.0V.

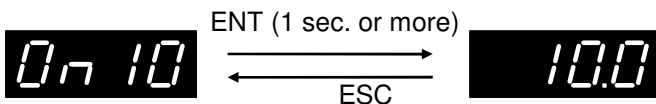

(11) Input/output signal

ON/OFF of the sequence input/output signal to the servo amplifier is displayed. When the input signal is ON, the corresponding LED illuminates.

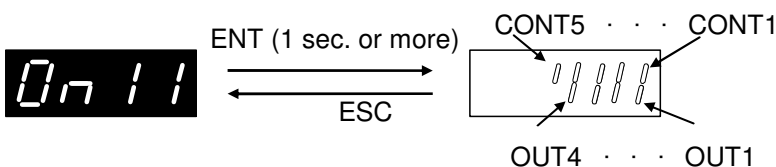

Chapter 8 – Keypad

(12) Load inertia ratioNo. of displayed digits: 3 digits without sign

Regardless of the tuning mode selection for parameter No. 5, the load inertia ratio recognized by the servo amplifier is displayed. The value is displayed with multiplication (increments of 0.1) of the servomotor inertia moment. The display range is a multiplication of 1.0 to 99.9.

$$(\text{Load inertia ratio}) = \frac{(\text{Load inertia moment recognized by servo amplifier})}{(\text{Inertia moment of servomotor})}$$

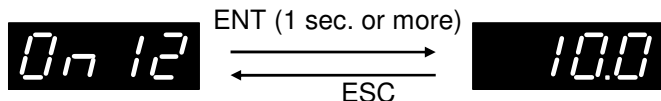

(13) OL thermal valueNo. of displayed digits: 3 digits without sign

The load ratio when the load alarm level is 100 is displayed. When the value is 100, an overload alarm occurs. The minimum unit is 1%. The display range is 0% to 100%.

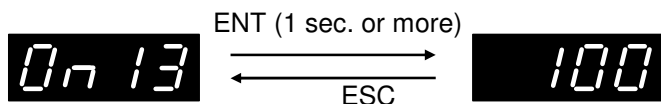

(14) Regenerative resistance thermal value No. of displayed digits: 4 digits without sign

The regenerative load ratio is indicated, assuming the regenerative resistance overheat alarm level as 100. When the value reaches 100, a regenerative resistance overheat alarm is issued. The minimum unit is 1%. The display range is 0% to 100%.

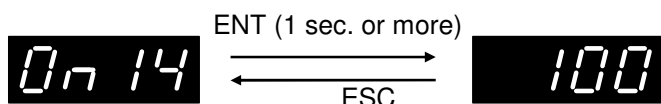

(15) Pulse string frequencyNo. of displayed digits: 4 digits with sign

The pulse string frequency added to the pulse string input terminal is displayed. The minimum unit is 0.1 [kHz]. The display range is -999.9 kHz to 999.9 kHz.

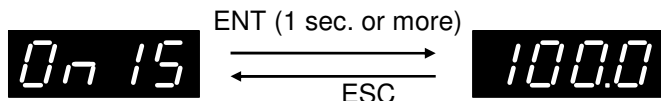

Chapter 8 – Keypad

(16) DC link voltage (maximum value) No. of displayed digits: 3 digits without sign
DC link voltage (maximum value) of the servo amplifier every 2 seconds is displayed.
The display range is 0V to 500V.

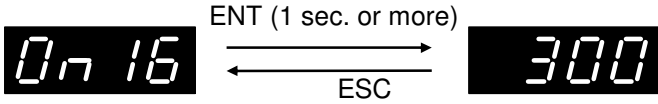

Hint If the DC link voltage (maximum value) exceeds 385V during operation, an external regenerative resistor is required. The detection level of "HV" (overvoltage) is 420V.

(17) DC link voltage (minimum value)No. of displayed digits: 3 digits without sign
DC link voltage (minimum value) of the servo amplifier every 2 seconds is displayed.
The display range is 0V to 500V.

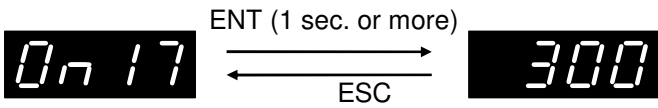

Hint The detection level of "LV" (undervoltage) is 210V.

Parameter editing mode

In the parameter editing mode, parameters can be edited.

Display [*Pn01*] with the MODE key and select parameter editing with the ENT key (1 sec. or more) input. After selecting parameter input, select the parameter number for editing with the ^ or v key. With the ENT key input, the details can be edited.

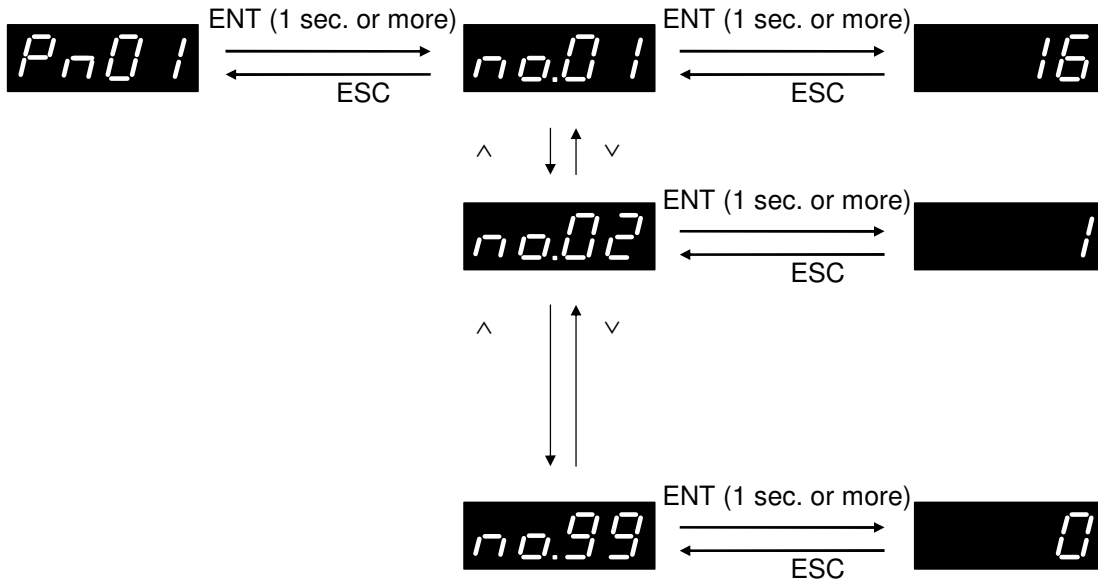

Chapter 8 – Keypad

(1) Indication and editing

The indication and editing methods for parameter are as follows.

• Value indication

<Parameter of 3 digits or less without sign>

The value of 3 digits or less without sign is displayed as is.



The example on the left indicates that there are 2 digits for value settings.

To indicate the digit of value, zero suppress is not performed other than for the digits for setting.

<Parameter of 3 digits or less with sign>

The value of 3 digits or less with sign has a sign to the left and the value is displayed in the remaining digit as is.



<Parameter of 4 to 5 digits or less without sign>

"H" is displayed at the left end for the upper 3 digits.

"L" is displayed at the left end for the lower 3 digits.

■ Upper 3 digits

■ Lower 3 digits

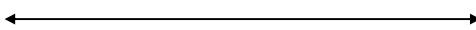

<Parameter of 4 to 5 digits with sign>

For the upper 3 digits, "H" is displayed at the left end for positive value and "-" is displayed for negative value.

For the lower 3 digits, "L" is displayed at the left end.

• For positive value

• For negative value

■ Upper 3 digits

■ Lower 3 digits

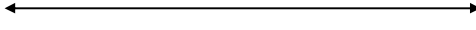
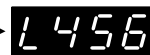

■ Upper 3 digits

■ Lower 3 digits

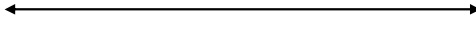
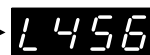

Chapter 8 – Keypad

• Editing a Value

When a parameter is read, the last digit (right end digit) is blinking. (For parameter with H and L, H details are displayed.) The blinking digit can be edited. (It blinks at an interval of approx. 1 sec.)

Press the ^ or v key changes the value.

When 9 is increased to 0, the upper digits are not changed.

On the other hand, when 0 is decreased to 9, the upper digits are not changed.



Increase the value of "9" for the third digit by one with the ^ key.



When the third digit is increased to "0", the upper digits are not changed.

Shift the digit for editing in sequence with the SHIFT key. The sequence for shifting is ① to ③ as shown below

• H (upper 4 digits)

• L (lower 4 digits)



① ② ③

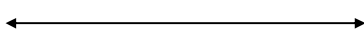

④ ⑤ ⑥

• Storing the value

Press and hold the ENT key for 1 sec or more to store the value. All digits blink three times simultaneously. The stored value remains as it is. (The stored value blinks at about 0.5 second intervals.)

When the ESC key is input, the screen returns to the parameter number selection screen.

• Value beyond the specified range

When the number of digits is effective, a value outside the setting range can be input.





















Ex.) For parameter No. 1, 0 to 99999 can be input (Setting range: 1 to 32767).

The value outside the setting range cannot be used as the parameter. (NG is displayed.)

Chapter 8 – Keypad

• Editing example

Change the manual feed speed of 3 in parameter No. 33 to 1.0.

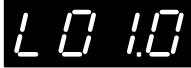
Keying	Indication	Remarks
		The action mode in the sequence mode is displayed.
		Returns to mode selection.
		Select the parameter mode.
 (1 sec. or more)		Display the parameter number.
		Select parameter No. 33.
 (1 sec. or more)	Blinking 	Settings of No. 33 are displayed. The first digit of H (upper 3 digits) is blinking. (Upper 2 digits of initial value 1000.0 are displayed.)
	Blinking 	Decrease the value to 0.
	Blinking 	Display L (lower 4 digits).
	Blinking 	Shift to the editing digit.
	Blinking 	Change the value to "1."
 (1 sec. or more)		Define the changed value.
		The stored value remains as it is.

Test running mode

In the test running mode, keying on the Keypad can rotate the servomotor or reset various settings. Press the MODE key to display [Fn0n] and hold down the ENT key for at least 1 second to execute test running.

Fn01: Manual feed	Fn05: Alarm history initialization	Fn09: Auto tuning gain
Fn02: Position reset	Fn06: Parameter initialization	Fn10: Easy tuning
Fn03: Cumulative pulse clear	Fn07: Auto offset adjustment	Fn11: Pattern operation
Fn04: Alarm reset	Fn08: Phase-Z position adjustment	

(1) Manual feed

The servomotor rotates while a key on the Keypad is pressed. The servomotor speed is as per the setting of parameter #31.

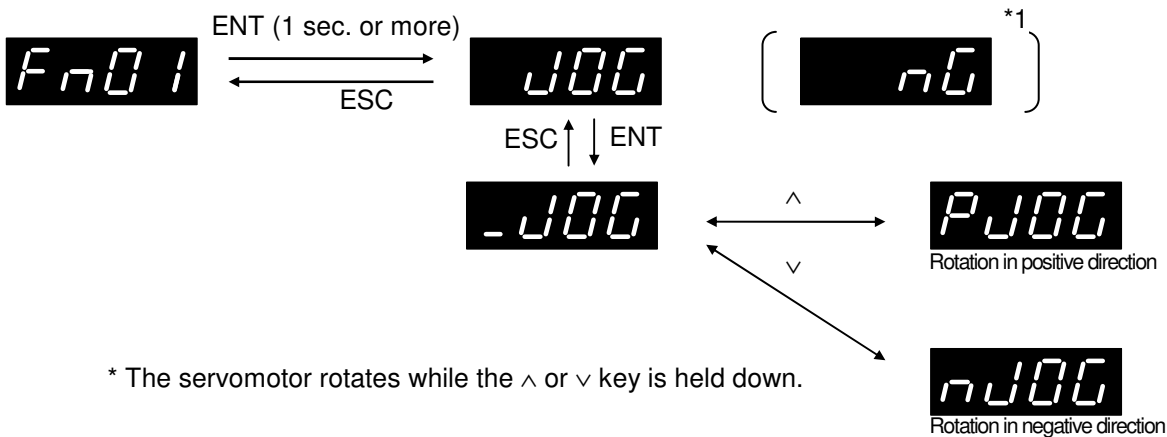

While the servomotor is rotating with the sequence input/output signal, [NG] is displayed.

*1) Cause of NG display

- RUN signal and FWD/REV signal are ON.
- Motor is rotating.



Forced stop, external regenerative resistor overheat, ±OT and coasting signals are valid during test operation. If test operation is faulty, check the signals above.

Chapter 8 – Keypad

(2) Position reset

Reset (0) the current command position and the current feedback position of the servomotor.

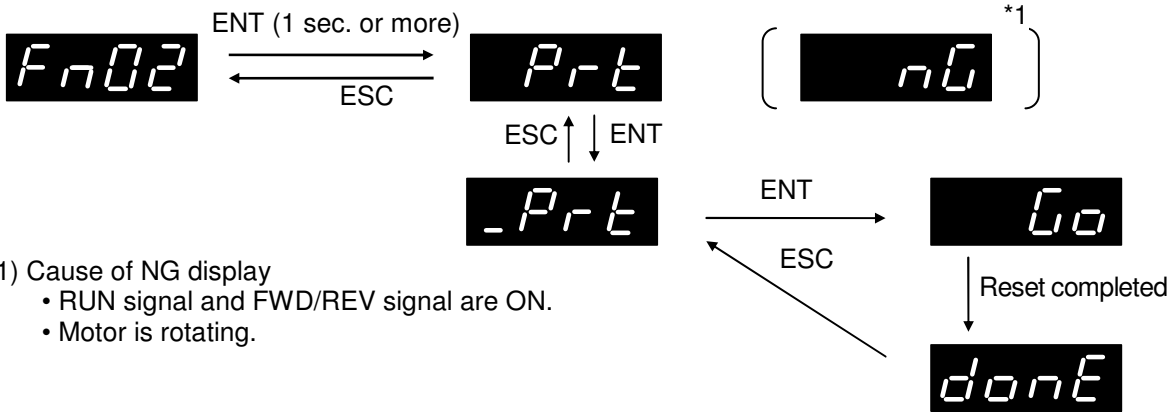

- *1) Cause of NG display
- RUN signal and FWD/REV signal are ON.
 - Motor is rotating.

(3) Cumulative pulse clear

The command cumulative pulse and the feedback cumulative pulse of the servo amplifier are cleared.

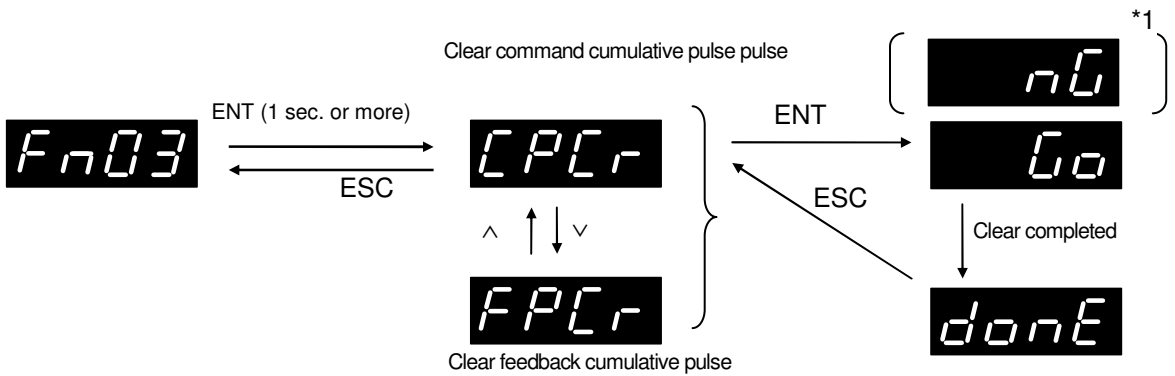

- *1) Cause of NG display
- RUN signal and FWD/REV signal are ON.
 - Motor is rotating.

(4) Alarm reset

Resets the alarm detected by the servo amplifier.

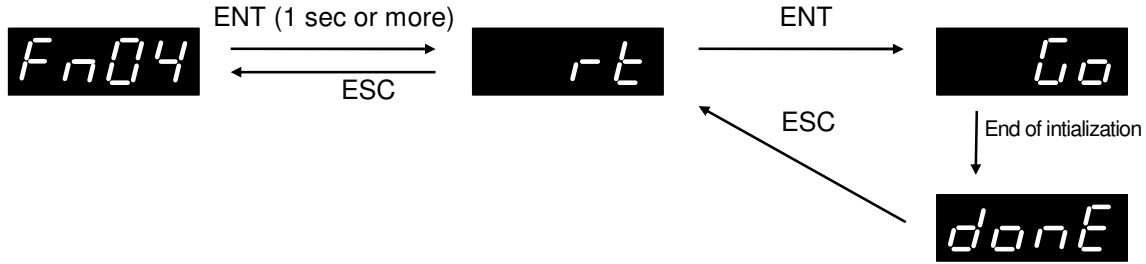

* Some alarms cannot be reset with the alarm reset. For these alarms, supply the power again to reset the alarms.

■ Alarms that can be reset with the alarm reset

Indication	Description
OC1	Overcurrent 1
OC2	Overcurrent 2
OS	Overspeed
HV	Overvoltage
rH2	Regenerative transistor overheat
EC	Encoder communication alarm
OL	Overload
LV	Undervoltage
rH1	Regenerative resistor overheat
DF	Deviation limit
AH	Amplifier overheat

■ Alarms that are reset with the re-supply of power

Indication	Description
Et	Encoder trouble
Ct	Control power alarm
dE	Memory alarm
Cnt	CONT duplication

(5) Alarm history initialization

Deletes the alarm detection log recorded in the servo amplifier. The alarm detection history (alarm history) can be monitored in sequence mode [Fn04].

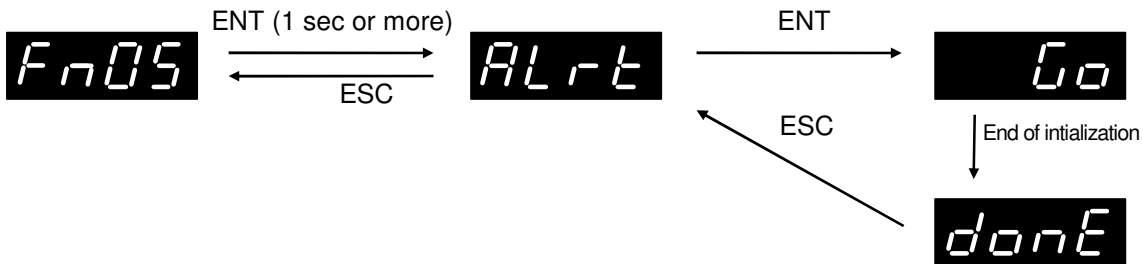

* The alarm history is retained even when the power is turned off.

Chapter 8 – Keypad

(6) Parameter initialization

Initializes the parameters.

* After initializing, turn the power off then on again.

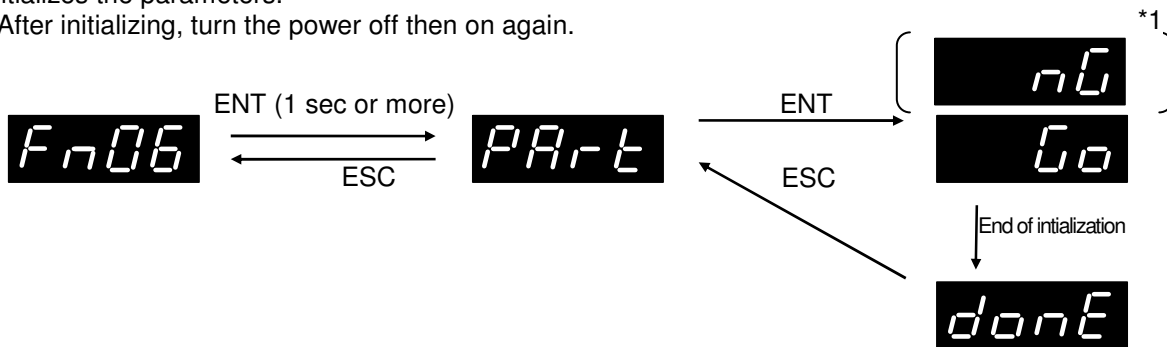

*1) Cause of NG display

- RUN signal is ON.
- Write-protection selected at parameter #29 (write-protection of parameters)

(7) Automatic offset adjustment

The current input voltage at the sequence input terminal [Vref] is 0V.

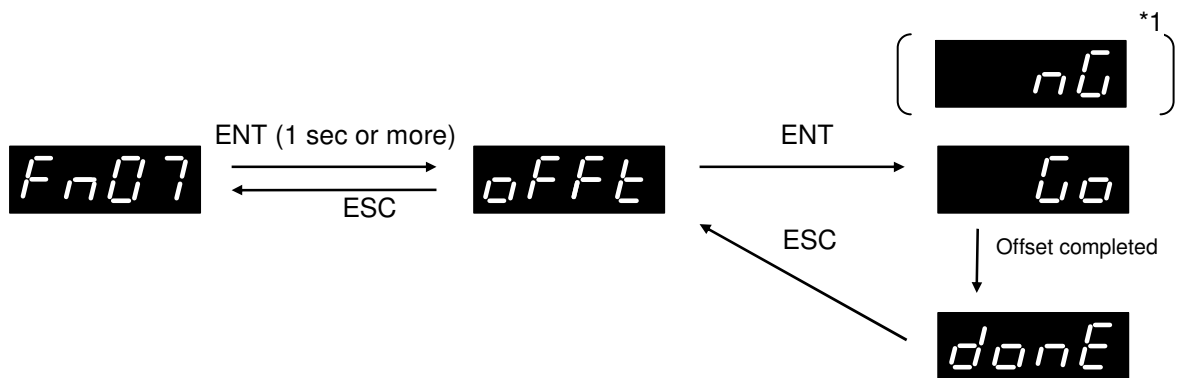

When all X1 and X2 terminals of the multistep speed selection are OFF with FWD (REV) signal, the servomotor output shaft rotates according to the analog speed command voltage.

When the speed command voltage is decreased to 0V, the output shaft of the servomotor may rotate at a very low speed.

→ If required, use the "zero clamp function."

The adjusting procedure of the offset voltage is as follows:

- ① Apply voltage of 0V to the [Vref] terminal. The operation command may be given or not given at your discretion.
- ② Select [Fn07] on the keypad. When the ENT key is input, the offset is automatically adjusted.
- ③ Turn ON the operation command [RUN] signal and make sure that the output shaft of the servomotor does not rotate.

*1) Cause of NG display

- Write-protection selected at parameter #29 (write-protection of parameters)



- The adjusted results are stored in parameter No. 71.
- With changes of the servo amplifier environments, offset adjustment may be required again. When the servo amplifier is controlled with the upper level controller using the speed command voltage and the dividing output (feedback), do not select this adjustment.

(8) Phase-Z position adjustment

Defines the current position as the phase-Z position. With Z phase position adjustment, the distance from the current position to Z phase is automatically set to parameter No. 20 (Z phase offset).

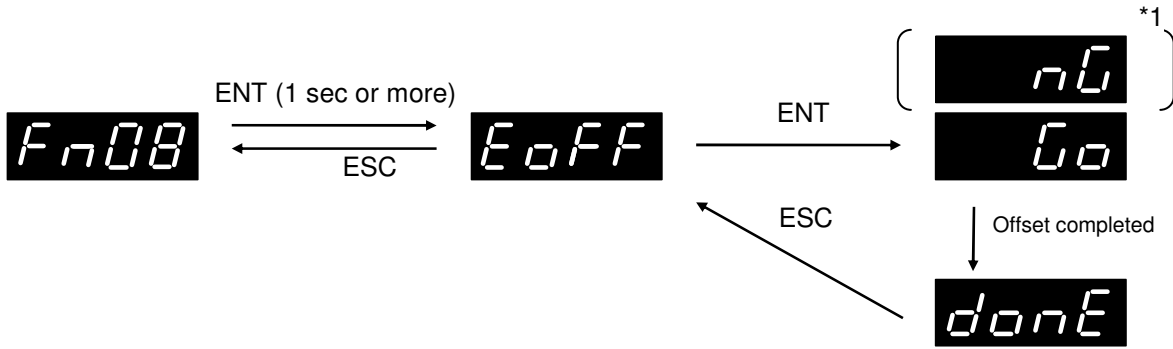

*1) Cause of NG display

- Write-protection selected at parameter #29 (write-protection of parameters)
- Encoder origin (phase-Z) establishment failure (immediately after power-on)
 → Turn the motor shaft at least twice to establish the phase-Z origin.

(9) Auto tuning gain setting

Parameter #7 (auto tuning gain) is refreshed at real time.

Unlike the other parameters, an increase or decrease is reflected on the data immediately (parameter #7 is not updated. However, parameter #7 is updated when the ENT key is pressed).

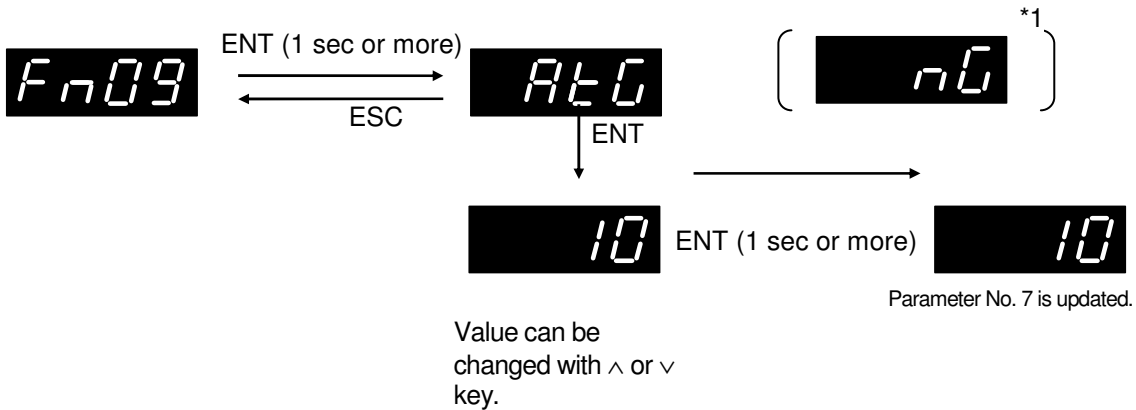

*1) Cause of NG display

- Write-protection selected at parameter #29 (write-protection of parameters)

Chapter 8 – Keypad

(10) Smart Tuning

The servomotor is automatically started and the auto tuning gain is automatically adjusted.

If wires are not connected to the upper level control systems, the optimum adjustment can be made according to the machine.

There are two operation patterns; slow run and Smart Tuning. For details, refer to Chapter 6.

Course name	Travel distance	Operation count	Acceleration time	Deceleration time	Rotation speed	Timer	Rotating direction	
							Forward	Return
Slow run	No. 84	1 reciprocal movement	No. 35	No. 36	10r/min	No. 86	CCW	CW
Easy tuning	No. 84	25 reciprocal movements	Automatic calculation	Automatic calculation	No. 85	No. 86	CCW	CW

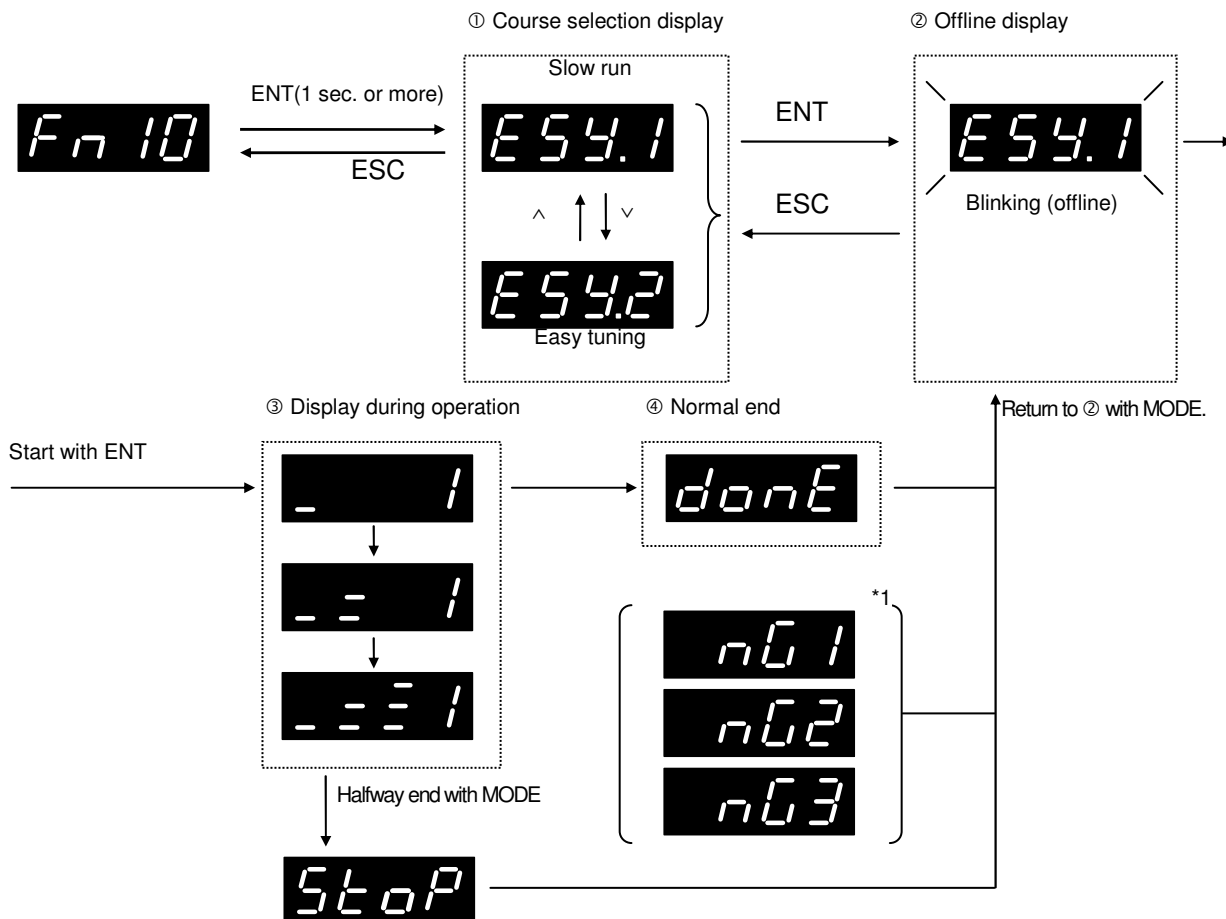

*1) If NG is displayed, remove the cause. Then, press the MODE key to return to ② Offline status.

<Cause of NG1 display>

- Parameter No. 29 (parameter write protect) is "1: Write protect."
- ±OT, EMG or external regenerative resistor overheating is detected.
- Parameter No. 5 (tuning mode) is not "0: Auto tuning."
- Power is not supplied to the main circuit.

<Cause of NG2 display>

- ±OT, EMG or external regenerative resistor overheating is detected halfway. (Coasting signal is ignored.)
- RUN signal is turned OFF.

<Cause of NG3>

- Auto tuning gain is 4 or less and the motor is oscillating.

Chapter 8 – Keypad

(11) Pattern operation

The servomotor is continuously operated. When this is started, reciprocal operation is continued until operation is stopped. If wires are not connected to the upper level control system, continuous operation can be performed. This operation is used to confirm the actual torque.

Course name	Travel distance	Operation count	Acceleration time	Deceleration time	Rotation speed	Timer	Rotating direction	
							Forward	Return
Pattern operation	No. 84	Infinite	No. 35	No. 36	No. 85	No. 86	CCW	CW

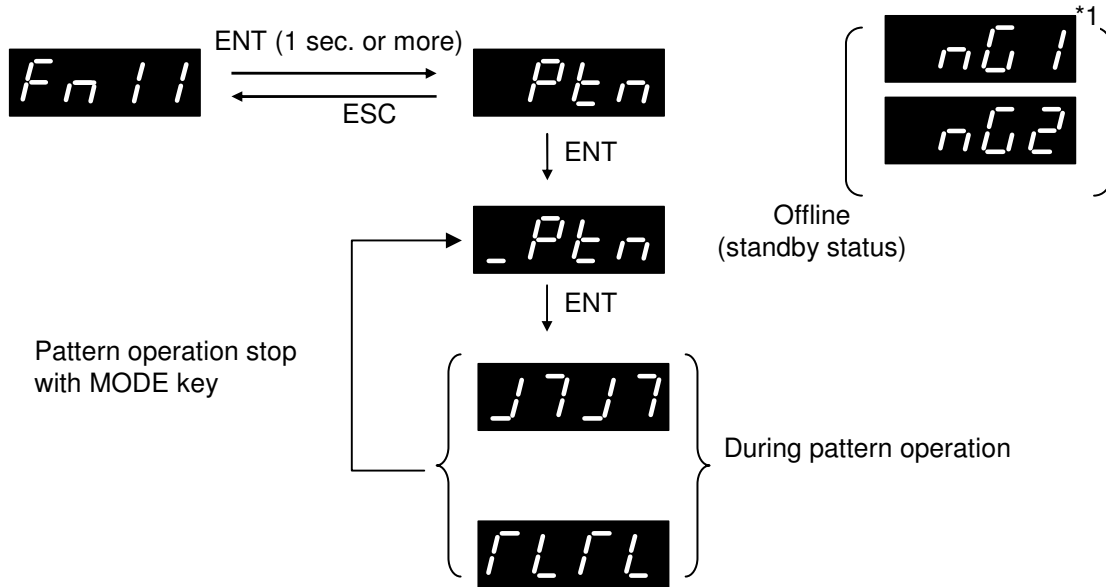

*1) If NG is displayed, remove the cause. Then, press the MODE key to return to Offline status.

<Cause of NG1 display>

- ±OT, EMG or external regenerative resistor overheating is detected.
- Power is not supplied to the main circuit.

<Cause of NG2 display>

- ±OT, EMG or external regenerative resistor overheating is detected halfway. (Coasting signal is ignored.)
- RUN signal is turned OFF.

Chapter 9 – Inspection and maintenance

Inspection

The servo amplifier (BSD type) consists of electronic parts and requires no routine inspection.

The servomotor is of a synchronous type (brushless) and has no part that requires routine maintenance.

Though both the servo amplifier and servomotor are maintenance-free, perform periodic inspection to avoid possible accidents and keep reliability of the equipment.

DANGER

- Prior to inspection, turn off power and wait for at least five minutes. Otherwise, there is a risk of electric shock.
- Do not touch the servo amplifier when the commercial power is supplied. If attempted, there is a risk of electric shock.

Inspection items are as follows

Inspection item

Device	Description
Servomotor	Misalignment of mechanical coupling Direct exposure to water, steam or oil Abnormal vibration
Servo amplifier	Loose screws of terminal block and fastening parts Excessive accumulation of dust Foreign odor, damage due to heat, breakage or external deformation Cable-wire discontinuation

Before checking electrical wirings, turn off the power and wait for 5 minutes and then check that the [CHARGE] LED is off on the keypad.

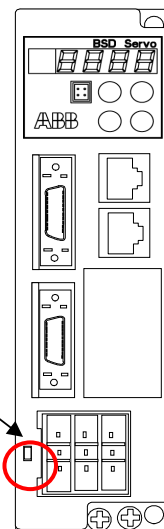

CAUTION

- Do not perform megger test on the PC-board or terminal block of servo amplifier. If attempted, the servo amplifier and the encoder housed in the servomotor may be broken.

Memory back-up

(1) Memory back-up

An electrically erasable programmable read-only memory (EEPROM) is used for retaining the parameters and alarm detection history after turning off power supply.

Each area can be initialized by turning off the servo amplifier operation command [RUN] (while motor is de-energized).

① Initialization of parameter

To initialize, select the initialization of parameter in the test running mode and press the ENT key.

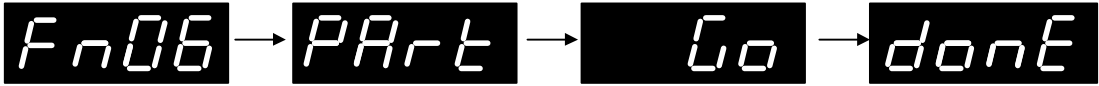

* After the initialization, be sure to turn on power again.

The initialization is not allowed if rewrite is inhibited by parameter #29.

The initialization is impossible while the motor is energized with the [RUN] signal on.

② Initialization of alarm detection history

The alarm detection history is held at all times. It can be initialized by the initializa`Fn05`] of history in the test running mode of the keypad.

(2) Copying the parameter

Use of the BSD Configurator can copy the setting contents of servo amplifier to the loader or, reverse, the loader contents can be transferred to the servo amplifier.

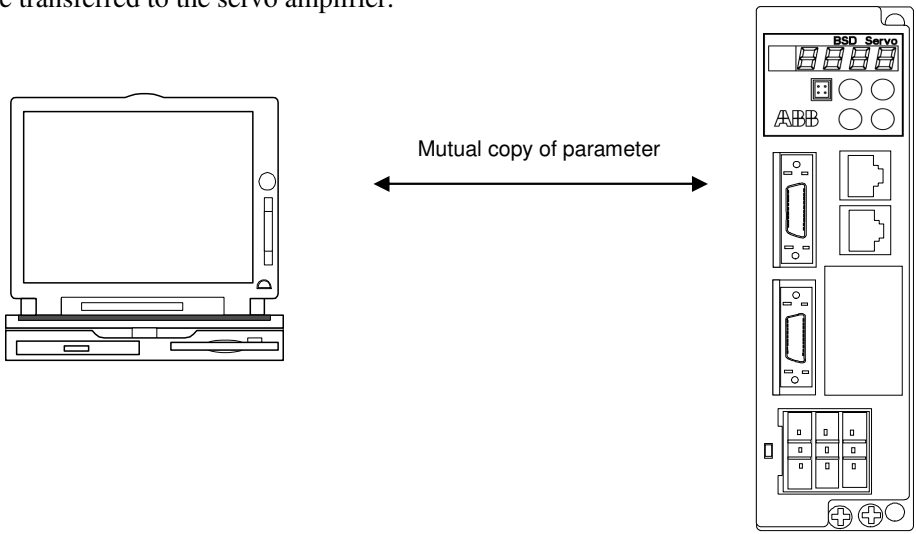

Alarm indication

The fault diagnosis is explained in three sections below.

- (1) Initial status
- (2) When error (failure) is not displayed
- (3) Faults with alarm indication and remedy

(1) Initial status

When the commercial power is supplied to the servo amplifier, the 7 segment of the keypad displays the value set by parameter # 30

The LED at the front of the servo amplifier for [CHARGE] illuminates.

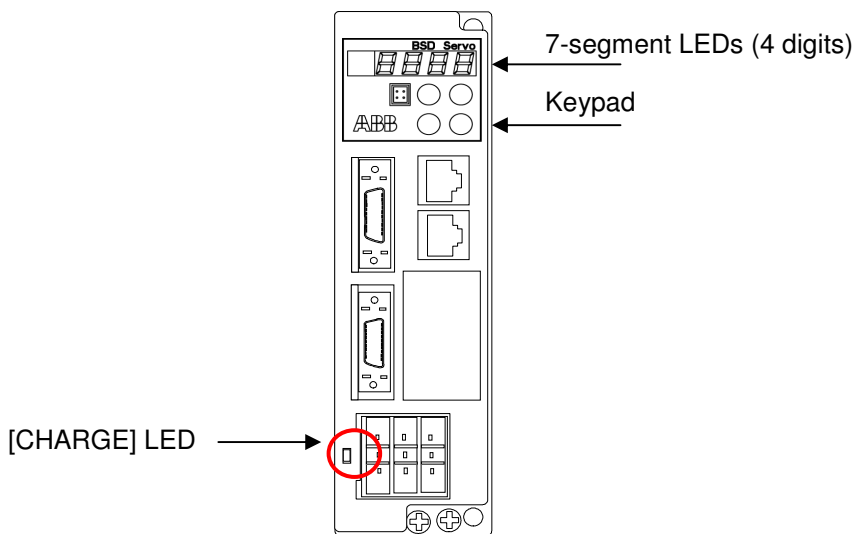

When the 7 segment does not illuminate after the power is supplied, the servo amplifier may be damaged. Please contact us.

(2) When error (failure) is not displayed

This type of failure is described by classification into the following three types:

- ① Servomotor does not rotate.
- ② Servomotor hunting
- ③ Positioning accuracy is poor.

If correct operation is not obtained after troubleshooting, contact us.

If an alarm is indicated at the keypad of the servo amplifier, refer to item (3).

① Servomotor does not rotate.

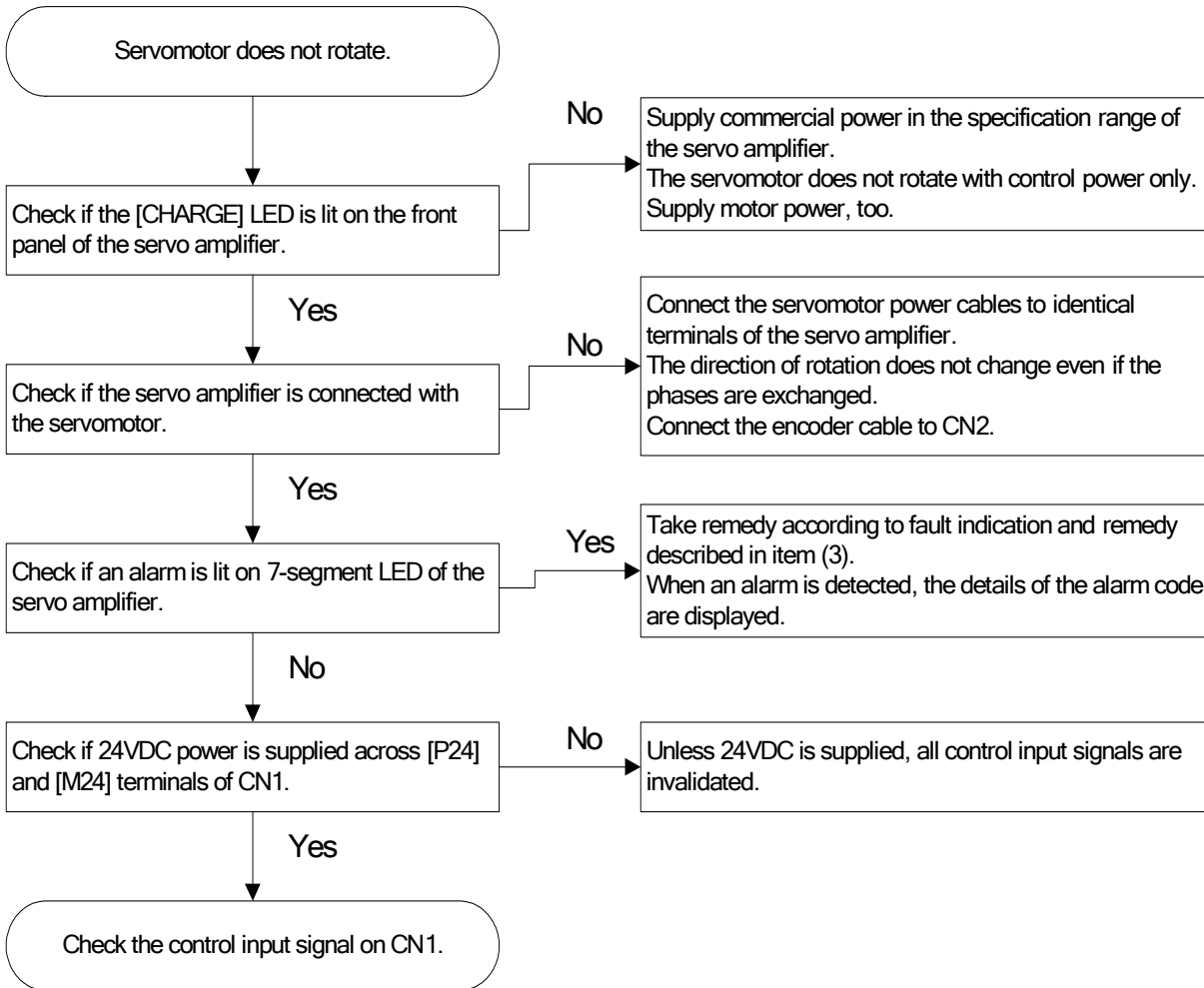

Hint Action mode check

Check the state of the servo amplifier.

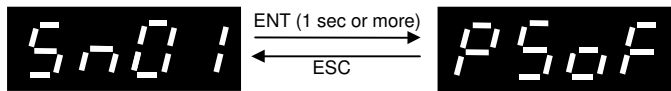

Indication (1st digit)	Sequence
P	Position control
n	Speed control
t	Torque control

Indication (2 to 4 digits)	Sequence
50F	Base off. Servomotor has no drive force. Coasting.
50n	Waiting for command with the servo ON.
P1n	The servomotor is ready to rotate. Pulse string input is effective.
100	The servomotor is ready to rotate by manual operation (test running).
Pot	Stopped under detection of positive overtravel signal.
not	Stopped under detection of negative overtravel signal.
n0	Stopped at zero speed upon forced stop signal input.
Lu	Undervoltage is detected.

② Servomotor hunting (Servomotor shaft alternates forward and reverse rotation repeatedly at a short interval.)

For the servo amplifier, the auto tuning function is made active by factory setting.
The auto tuning function is valid for most machines. It may not function correctly depending on the machine configuration.

If hunting occurs without connection to the output shaft of the servomotor, check the following items.

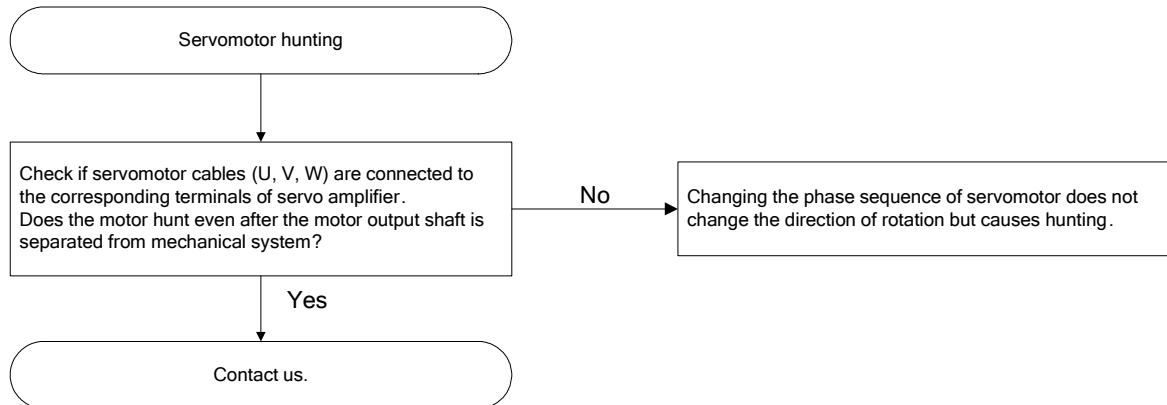

If hunting occurs with a machine connected to the output shaft of the servomotor, refer to chapter 6.

③ Poor positioning accuracy

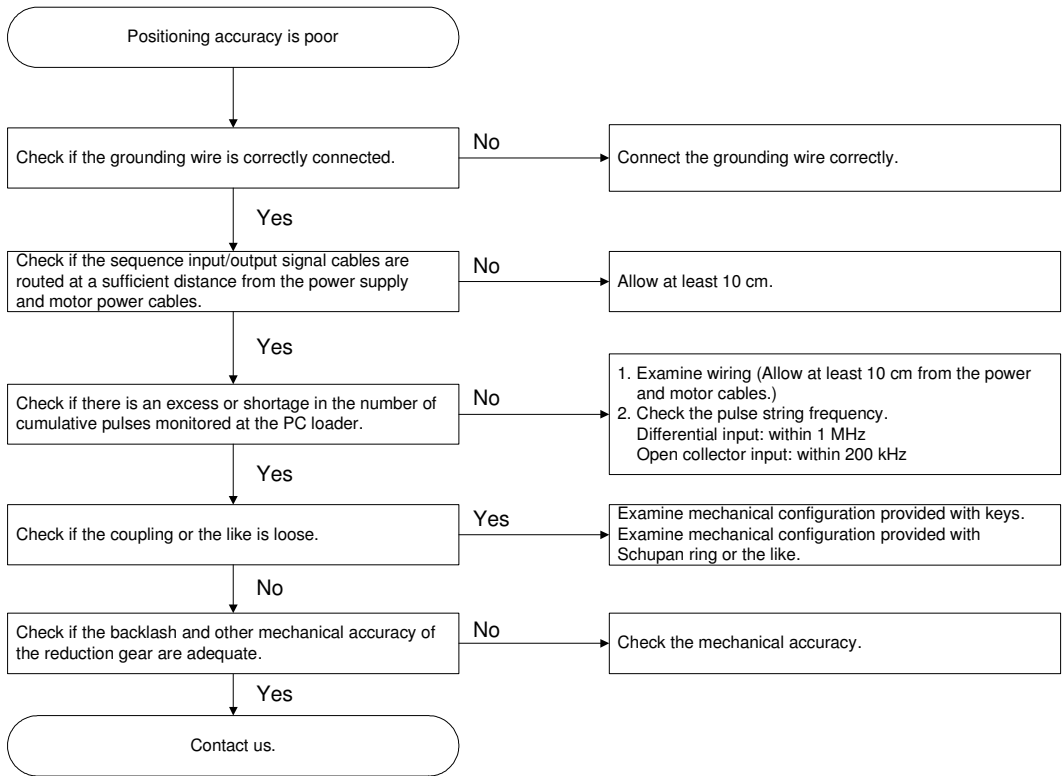

Chapter 9 – Inspection and maintenance

(3) Details of alarm detection

When an alarm is detected, the alarm code is automatically displayed blinking on the keypad of the servo amplifier. If multiple alarms are detected simultaneously, the alarm code with a higher priority blinks. See the table below for the priority order.

Priority	Indication	Description
1	OC1	Overcurrent 1
2	OC2	Overcurrent 2
3	OS	Overspeed
4	HV	Overvoltage
5	Et	Encoder trouble
6	Ct	Control power alarm
7	dE	Memory alarm
8	rH2	Regenerative transistor overheat
9	EC	Encoder communication alarm
10	Cnt	CONT duplication
11	OL	Overload
12	LV	Undervoltage
13	rH1	Regenerative resistor overheat
14	DF	Deviation limit
15	AH	Amplifier overheat

The 7 segment of the keypad blinks at intervals of approx. 0.5 sec.

(4) Operation for alarm detection

The servomotor decelerates and stops upon detection of an alarm. The operation varies depending on the detection.

<Action upon alarm>

- Coasting to stop upon detection

Indication	Description	Page
OC1	Overcurrent 1	9-11
OC2	Overcurrent 2	9-11
OS	Overspeed	9-11
HV	Overvoltage	9-12
Et	Encoder trouble	9-12
Ct	Control power alarm	9-13
dE	Memory alarm	9-13
rH2	Regenerative transistor overheat	9-14
EC	Encoder communication alarm	9-14
Cnt	CONT duplication	9-15

- The servomotor decelerates at the maximum torque and coasts after stopping.

Indication	Description	Page
OL	Overload	9-15
LV	Undervoltage	9-16
rH1	Regenerative resistor overheat	9-16
DF	Deviation limit	9-17
AH	Amplifier overheat	9-17

Chapter 9 – Inspection and maintenance



An alarm is automatically displayed if detected.

When this is displayed, the alarm can be reset with the sequence input signal (reset).

The alarm detection of encoder error, control power error, memory error and CONT duplication cannot be reset with the sequence input signal.

In this case, shut off the power and make sure that the display of the keypad goes off. Then, re-supply the power.

Alarm detection can be reset in the test running mode [**Fn04**] also.

1. Overcurrent

[Display]



[Details of detection]

The output current of the main circuit transistor exceeded the specified value.

[Factor and action]

Factors for overcurrent	Actions
Output wire of the motor is wrong.	Connect wires to the servo amplifier and the servomotor by checking the phase sequence.
Output wire of the motor is short-circuited between phases.	Check the resistance values between U-V, V-W and W-U.
Output wire of the motor is short-circuited with the grounding.	Check the resistance value with the grounding wire.
Grounding wire is not connected. (malfunction)	Connect the grounding wire.
The resistance value of the regenerative resistor is not proper.	Check the resistance value of the connected regenerative resistor.
The current is imbalanced due to the malfunction of the encoder.	Replace the servomotor.

The power wire to the servomotor may have a ground fault or short-circuit. The resistance with the ground wire is usually several MΩ or more. The resistance value between coils is balanced.

2. Overspeed

[Display]



[Details of detection]

The rotation speed of the servomotor exceeded 1.1 times the maximum speed.

[Factor and action]

Factors for regenerative resistor overheating	Actions
Output wire of the motor is wrong.	Connect wires to the servo amplifier and the servomotor by checking the phase sequence.
The rotation speed is overshooting.	Increase acceleration time 1 (parameter # 35).
	Increase the S-curve time constant (parameter # 43).
	Increase the operation speed response (parameter # 41).

The motor rotation speed may be overshooting. Check the speed waveform during acceleration with the BSD Configurator.

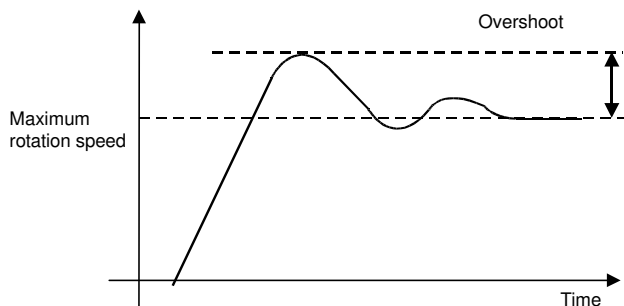

3. Overvoltage

[Display]



[Details of detection]

The DC link voltage inside the servo amplifier is larger than the limit value.

[Factor and action]

Factors for overvoltage	Actions
Power voltage is high (immediately after power supply).	Check the power voltage.
The external regenerative resistor is not connected.	Connect the external regenerative resistor. Check for wiring (disconnection) of the external regenerative resistor.
The regenerative transistor is damaged.	Replace the servo amplifier.

With the monitor mode on the keypad, the internal DC link voltage can be checked.

0n15 : DC link voltage (maximum value), **0n17** : DC link voltage (minimum value)

When overvoltage is approx. 420V, it is detected with the monitor above.

4. Encoder trouble

[Display]



[Details of detection]

The encoder inside the servomotor may be damaged.

[Factor and action]

Factors for encoder error	Actions
Encoder is damaged.	Replace the servomotor.
Encoder is vibrating.	Reduce the operating speed response (parameter # 41) and check the condition.

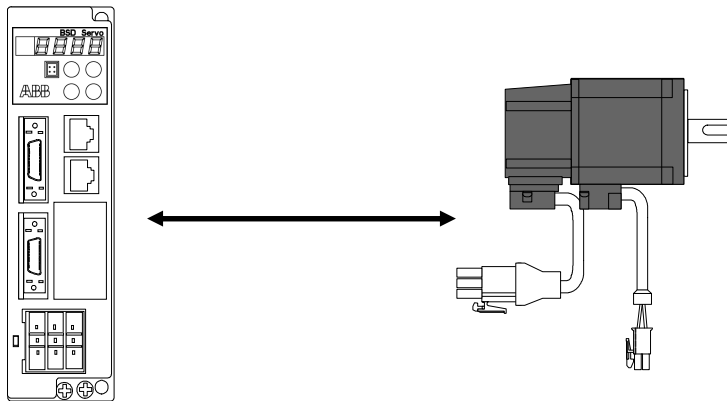

An alarm is detected with the self-diagnosis result of the CPU in the encoder.

In this case, communication is performed between the servo amplifier and the servomotor.

5. Control power alarm

[Display]



[Details of detection]

The internal control power of the servo amplifier is faulty.
The servo amplifier may be broken.

[Factor and action]

Factors for control power error	Actions
The servo amplifier is damaged.	Replace the servo amplifier.

If this alarm is detected, contact us.

6. Memory alarm

[Display]



[Details of detection]

The parameter contents stored in EEPROM in the servo amplifier are damaged.

[Factor and action]

Factors for memory error	Actions
Memory contents are damaged.	Initialize the parameter and check the condition.
Memory is damaged.	Replace the servo amplifier.

If a memory error has occurred, initialize the parameter.

If a memory error is still detected even after initialization, replacement of the servo amplifier is required.

7. Regenerative transistor overheat

[Display]



[Details of detection]

The regenerative transistor on the servo amplifier has overheated.

[Factor and action]

Factors for regenerative transistor overheating	Actions
Power voltage is high (immediately after power supply)	Check the power voltage.
Regenerative power cannot be consumed.	Increase the deceleration time and reduce the regenerative frequency.
	Reduce the rotation speed.

8. Encoder communication alarm

[Display]



[Details of detection]

Communication between the encoder on the servomotor and the servo amplifier is not performed.

[Factor and action]

Factors for encoder communication error	Actions
Encoder communication is interrupted.	When the optional cable is not used, check the wire specification.
	Check for disconnection of the wire.
	Place a ferrite core on the encoder wire and check the condition.

The encoder wire of the servomotor may be disconnected or cut.

The servo amplifier and the encoder are performing serial communication. Use the optional cable or the specified wire for the encoder cable.

Since the encoder wire has a voltage amplitude of approx. +5V, do not place the wire around a strong magnetic field or strong electric field. Keep the encoder wire separate from the servo amplifier unit, inverter and electromagnetic contactor (100 mm or more).

9. CONT input duplication

[Display]

[Details of detection]



Allocation of the sequence input terminal for the servo amplifier is duplicated.

[Factor and action]

Factors for sequence input duplication	Actions
The same input signals are allocated to multiple terminals.	Do not give the same numbers for parameters # 10 to 14. (Duplicate allocation is allowed only for forced stop.)

10. Overload

[Display]

[Details of detection]



The output torque effective value (command value) of the servo amplifier exceeded the allowable value of the combined servomotor.

(It is detected with the electronic thermal relay built into the servo amplifier.)

[Factor and action]

Factors for overload	Actions
The servomotor does not mechanically rotate.	Connect wires to the servo amplifier and the servomotor by checking the phase sequence.
	Make sure that the brake is not working.
Machine load is large compared to the motor capacity.	Review the capacity using the load ratio at a constant speed.
	If the rotation speed is low, review the deceleration ratio. If this error is detected during stoppage of the lifting machine, stop the machine with a brake.
Acceleration/deceleration frequency is high.	If this error does not occur by reduction of the operation frequency, review the capacity.
The servo amplifier is damaged.	Replace the servo amplifier.

If this alarm occurs at a constant speed or during stoppage, it is necessary to review the motor capacity.

When the operation frequency is high, reduce the operation frequency. If the alarm is not detected, the cause may be that acceleration/deceleration frequency is high.

In either case, check the OL thermal relay value with the monitor mode of the servo amplifier keypad.

11. Undervoltage

[Display]



[Details of detection]

The power supply to the servo amplifier is lower than the minimum voltage of the specification range.

[Factor and action]

Factors for undervoltage	Actions
The power voltage was reduced.	Check the power supply environment. This alarm is only detected when parameter 26 is set to 1.

The power supply voltage may be reduced due to instantaneous power failure. Or the power supply capacity may be insufficient.

If the power supply environment is poor, detection of undervoltage can be ignored by setting parameter # 27. In this case, if coasting is selected from the setting of parameter # 26, operation can be continued with instantaneous power failure.

Undervoltage can be checked with the display on the keypad.



The DC link voltage can be checked with the monitor mode of the keypad. If undervoltage is detected, it is approx. 210V of the DC link voltage.

12. Regenerative resistor overheat

[Display]



[Details of detection]

Heat of the regenerative resistor connected to the servo amplifier exceeded the upper limit.

[Factor and action]

Factors for regenerative resistor overheating	Actions
Power voltage is high (immediately after power supply)	Check the power voltage.
Regenerative power cannot be consumed.	Make the deceleration time longer. Reduce the regenerative frequency. Reduce the rotation speed.

13. Deviation limit

[Display]



[Details of detection]

Deviation (difference between the current command position and the current feedback position) exceeded the deviation limit width of parameter # 22.

[Factor and action]

Factors for deviation limit	Actions
The servomotor does not mechanically rotate.	Connect wires to the servo amplifier and the servomotor by checking the phase sequence. Make sure that the brake is not working.
Torque cannot be output.	Increase parameter # 25.
The deviation limit width is small.	Increase parameter # 22.
Acceleration is slow.	If "P motion" is set to be effective in the sequence input, cancel it. Adjust the gain according to chapter 6.
The pulse string frequency is quickly increased.	Perform soft start.

The initial value of standard parameter # 22 is 20000 (× 100) pulses.

When the deviation exceeds 2000000 pulses, alarm for deviation limit is detected. With the normal operation method of the servo amplifier, the deviation becomes larger in proportion to the rotation speed.

One rotation of the motor shaft is 131072 pulses. When deviation has become equivalent to approx. 15 rotations of the motor shaft, the deviation limit is detected.

If the deviation limit is detected when the operation command [RUN] is ON, a different power wire of the servomotor may be used.

14. Amplifier overheat

[Display]



[Details of detection]

The cooling fin temperature of the servo amplifier exceeded approx. 100 °C.

[Factor and action]

Factors for amplifier overheat	Actions
Ambient temperature exceeded 55 °C.	Use the system in an ambient temperature of 55 °C or less. To extend the life of the capacitor in the servo amplifier, it is recommended that the operation be 40 °C or less.
Regenerative power cannot be consumed.	Make the deceleration time longer.

Use the servo amplifier at the ambient temperature of +55 °C or less. The life of the large capacity capacitor in the servo amplifier is greatly affected by the ambient temperature.

Items to specify when faulty

If an alarm appears, remedy it by referring to Chapter 9.

If the alarm is ignored and reset without knowledge about the cause of the alarm to continue operation, damage will be caused to the servo amplifier and servomotor.

When contacting us, specify the following items.

(1) Data on rating plate

Type of servo amplifier and servomotor

→ Example. RYC201D3-VVT2

(2) Device configuration

Connected external resistor

→ Example. Connect the external regenerative resistor.

(3) Outline of mechanical equipment system driven by motor

→ Example. Ball-screw feed, vertical drive, reduction speed ratio 1/2

(4) Description of fault

① Running duration (years). Was the motor operated normally even once?

② Frequency of alarm occurrence, conditions

→ Example. When a certain device operates, the motor stops.

③ Alarm display contents

④ Is the alarm reproducible?

⑤ When does the alarm occur, during acceleration, during rotation at a constant speed, or during deceleration?

⑥ Is there any difference between forward rotation and reverse rotation?

⑦ Does the alarm occur under particular conditions?

→ Example. When [RUN] signal has been turned on.

→ Example. When a table has advanced to a particular position.

⑧ If you have the machine or the servo amplifier with the same specifications, does the alarm occur

even after the amplifier or the machine is replaced?

Expected service life and discharge

(1) Expected service life

The servomotor and servo amplifier are susceptible to aging under regular operating conditions.

Contact our service section for replacement of parts. Customers are not to disassemble or repair the unit themselves.

① Servomotor

The bearing life of the servomotor varies depending on the operation conditions.

If abnormal noise or vibration is found during inspection, it is necessary to replace the bearing.

② Brake built in servomotor

The brake built into the servomotor is the non-exciting operation type brake for retention.

It cannot be used for braking.

Use the brake only for retention of the servomotor stopped status.

③ Large capacity capacitor built in servo amplifier

The servo amplifier incorporates large capacity capacitors.

Contact us when replacement with new one is required.

(2) Discharge

① Servomotor

It can be discharged as a general industrial waste.

② Servo amplifier

It can be discharged as a general industrial waste.

Part replacement

The guideline for part replacement is as follows. The actual replacement period greatly varies depending on the operation environment and conditions

■ Servo amplifier

Part name	Standard replacement time (years)
Main circuit capacitor	73,000 hours (10 years)
Aluminum electrolytic capacitor	73,000 hours (10 years)
Cooling fan	30,000 hours (3 years)

■ Servomotor

Part name	Standard replacement time (years)
Bearing	20,000 to 30,000 hours (3 to 5 years)
Oil seal	5,000 hours
Encoder	30,000 hours (3 years)

Operating conditions

- Ambient temperature: Annual average 30°C/year
- Load ratio: 80% or less
- Operation rate: 20 hours or less/day

Chapter 10 – Characteristics

Timing chart

Power ON

(1) Operation only with the motor power supply (without using the control power supply) (recommended sequence)

- ① It takes about 1.5 seconds to complete the initialization of the servo amplifier after the motor power is turned ON.
- ② The completion of the initialization can be confirmed from the ON status of the servo alarm detection (b contact) signal.
- ③ The servo ON (RUN) signal is turned ON 0.4 second after the status of ② is confirmed.
- ④ The servo ready signal is turned ON, making the system ready to operate.

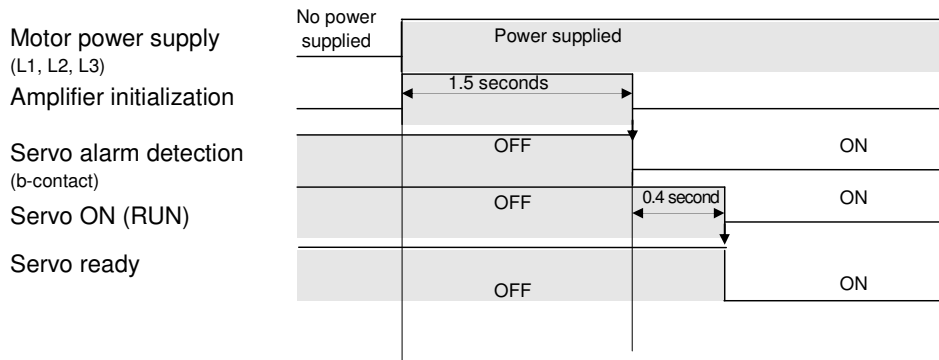

(2) Operation with the motor power supply and the control power supply (recommended sequence)

- ① It takes about 1.5 seconds to complete the initialization of the servo amplifier after the control power supply is turned ON.
- ② The completion of the initialization can be confirmed from the ON status of the servo alarm detection (b-contact) signal.
- ③ The servo ON (RUN) signal is turned ON 0.4 second after the status of ② is confirmed and the motor power supply is turned ON (*).
- ④ The servo ready signal is turned ON, making the system ready to operate.

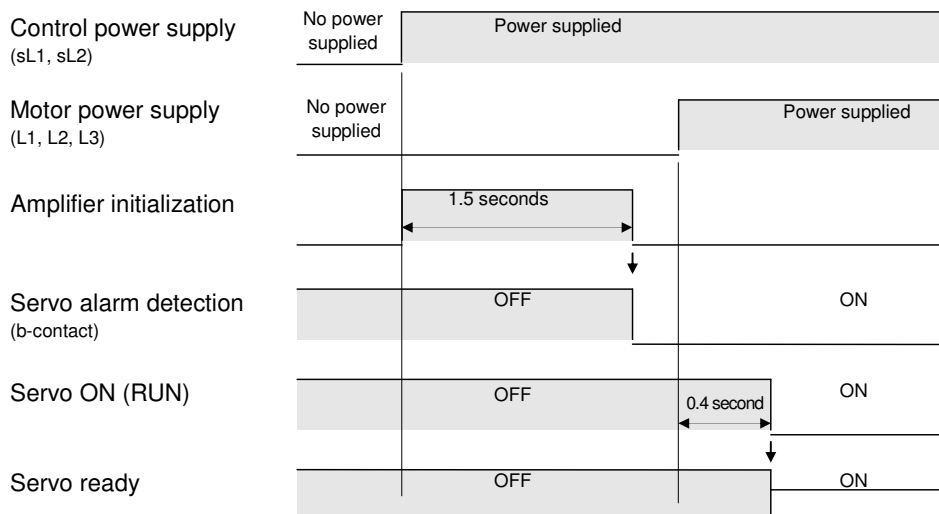

* The servo ON signal is turned ON only “when 0.4 second passes after the servo alarm detection (b-contact) signal and the motor power supply are both turned ON.”

Response time of sequence input signals

The response time from the input of a sequence signal to its recognition inside the servo amplifier is “5ms.” Keep the sequence input signal ON for 5ms or longer.

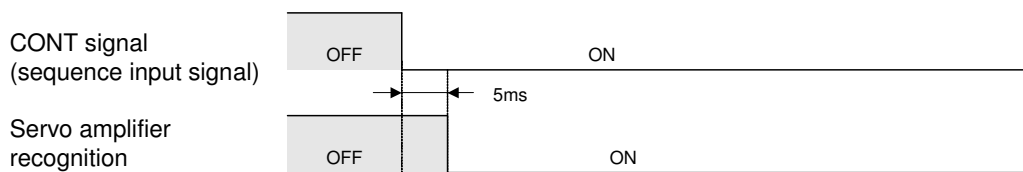

* Only the deviation clearance signal is recognized in 1ms. For details, see the figure below.
Keep the deviation clearance signal ON for 1ms or longer.

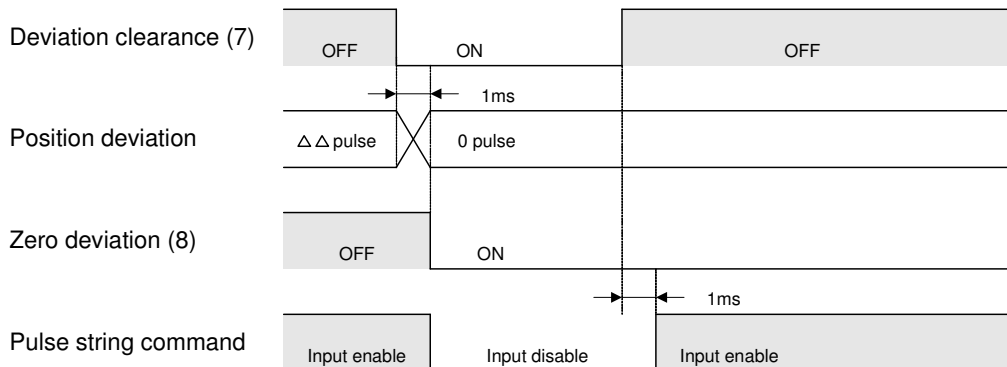

Switching to each control mode

The transition time to each control mode is 5ms.

Input the following commands 5ms or more after the switching signal is input.

Example) Switching from speed control to position control

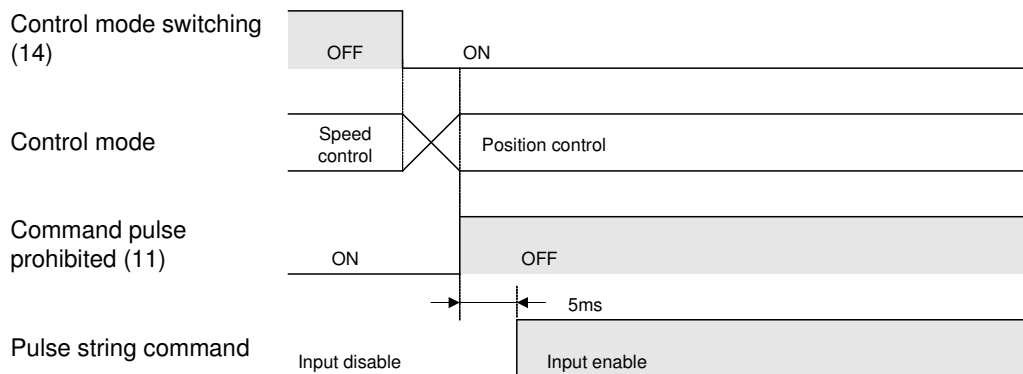

Alarm detection/reset

It takes about 5ms to output the alarm detection signal after an alarm occurs.

It takes about 5ms to actually reset an alarm after an alarm reset signal is input.

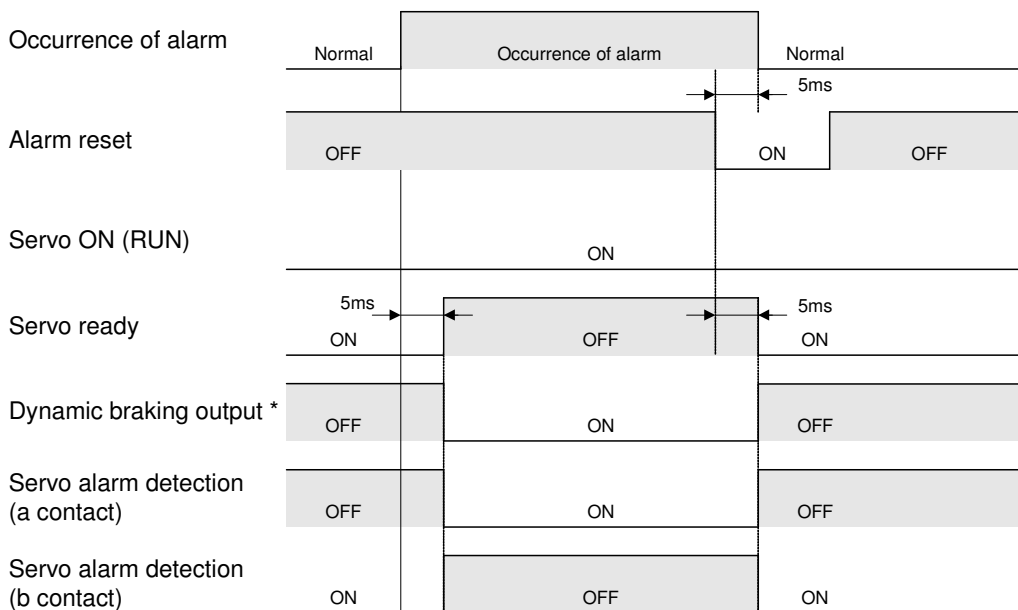

*) For the alarm of the dynamic braking output, refer to “Dynamic braking output” in chapter 5.

Returning to the hit-and-stop position regarded as the origin

(1) Method of returning to the origin in the position control mode

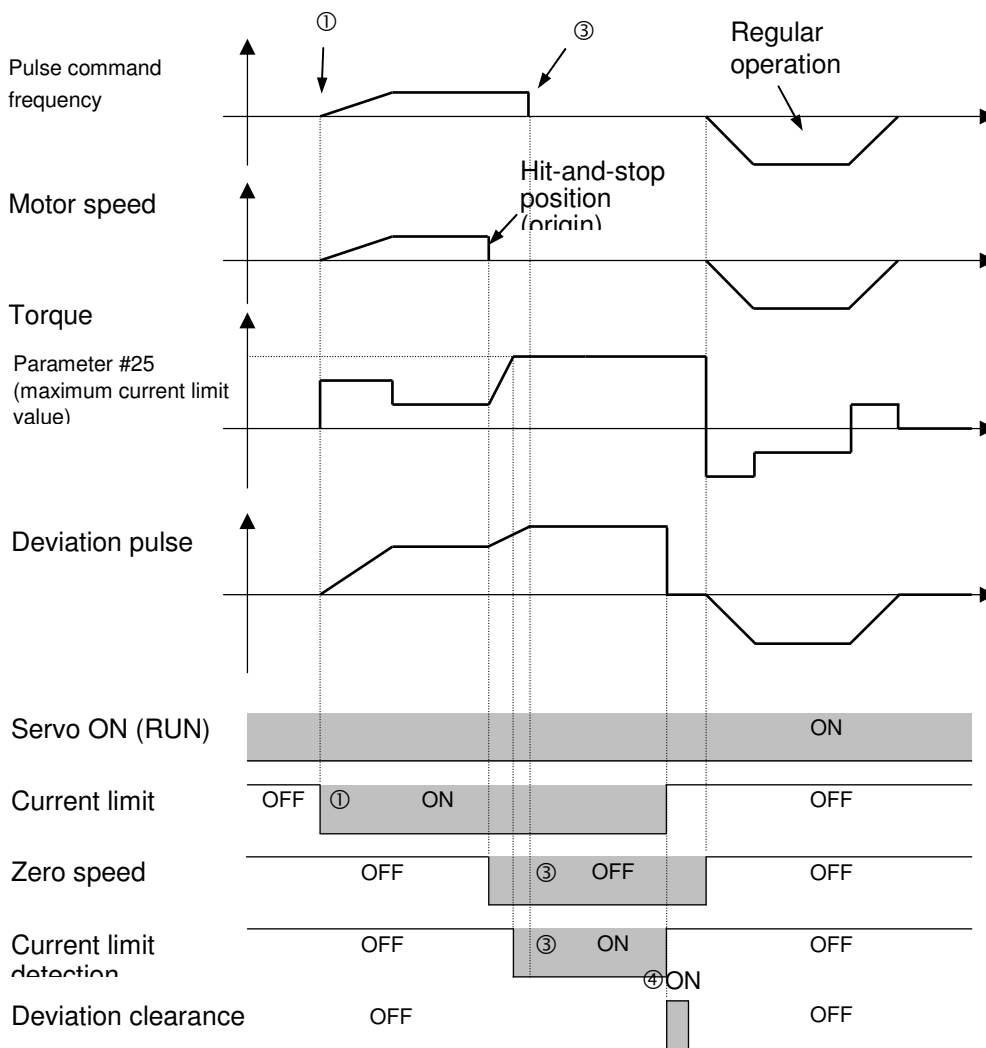

<Outline of operation>

- ① A return to the origin begins at low speed. At the same time, the current limit signal is turned ON.
- ② The motor stops running after it reaches the hit-and-stop position, and the torque rises to the current limit level.
- ③ The pulse command frequency signal stops as soon as both the zero speed and current limit detection signals are detected (AND condition).
- ④ The deviation clearance signal is always turned ON before regular operation begins.

<Precautions>

- Keep the deviation clearance signal ON for 5ms or more.
- Set the maximum current limit value (parameter #25) at 90% or below.
- Set the deviation over width (parameter #22) at as large a value as possible if necessary.

(2) Method of returning to the origin using the torque control mode

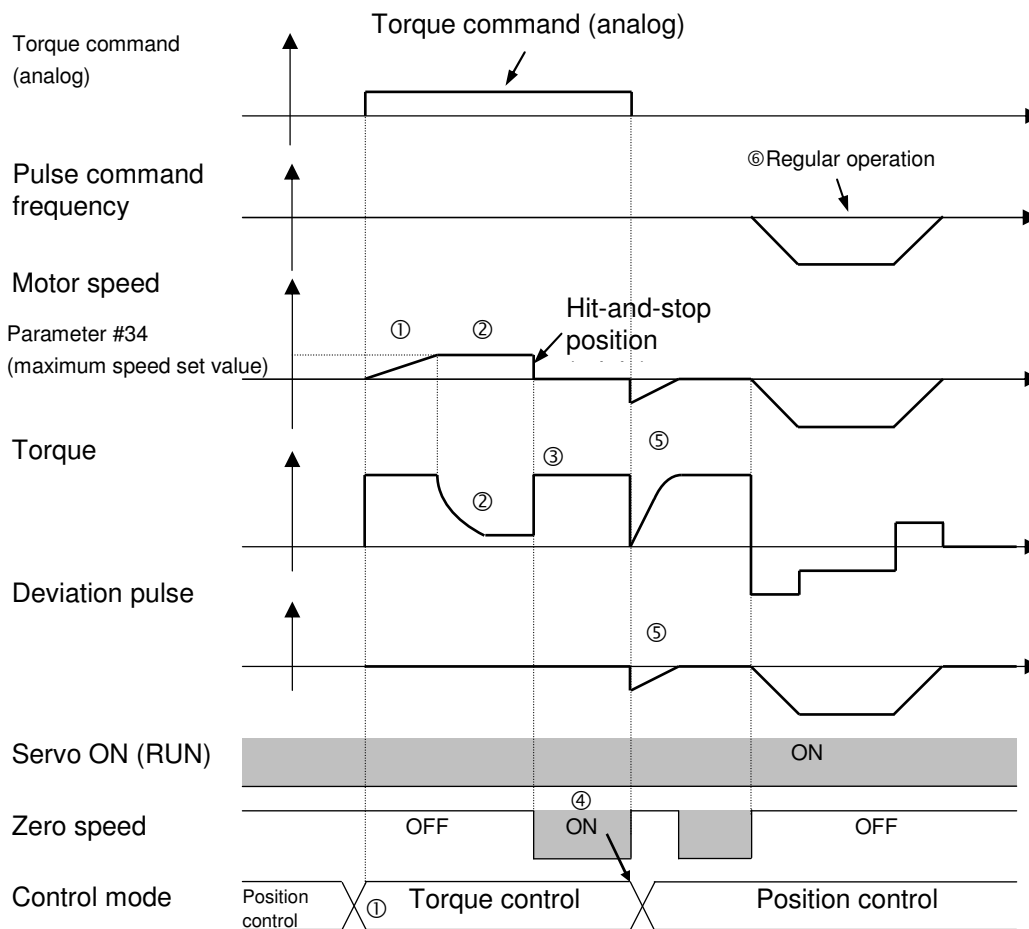

<Outline of operation>

- ① The control mode is switched to torque control, and a return to the origin begins at low speed.
- ② The torque decreases after the motor reaches the set maximum speed.
- ③ The motor stops running after it reaches the hit-and-stop position, and the torque rises to the command limit level.
- ④ After the zero speed signal is detected, the torque command (analog) signal stops, and the control mode is switched from torque control to position control.
- ⑤ Upon switching of the control mode to position control, the motor slightly returns due to reaction force. However, holding restarts because the position of the origin before the mode is switched is stored (the position of the origin remains unchanged).
- ⑥ It is confirmed that position control mode is active, and regular operation begins.

<Precautions>

- Set the maximum current limit value (parameter #25) at 90% or below.
- Set the deviation over width (parameter #22) at as large a value as possible if necessary.
- Set the maximum speed (parameter #34) at as small a value as possible if necessary.
(The maximum speed setting becomes invalid in the position control of pulse string input.)

Overload characteristics

Characteristics of detection time and load ratio until the overload alarm occurs are shown for each rotation speed

BSM (0.1-0.75 KW) motor

(1) Operation at rated rotation speed (3000 r/min)

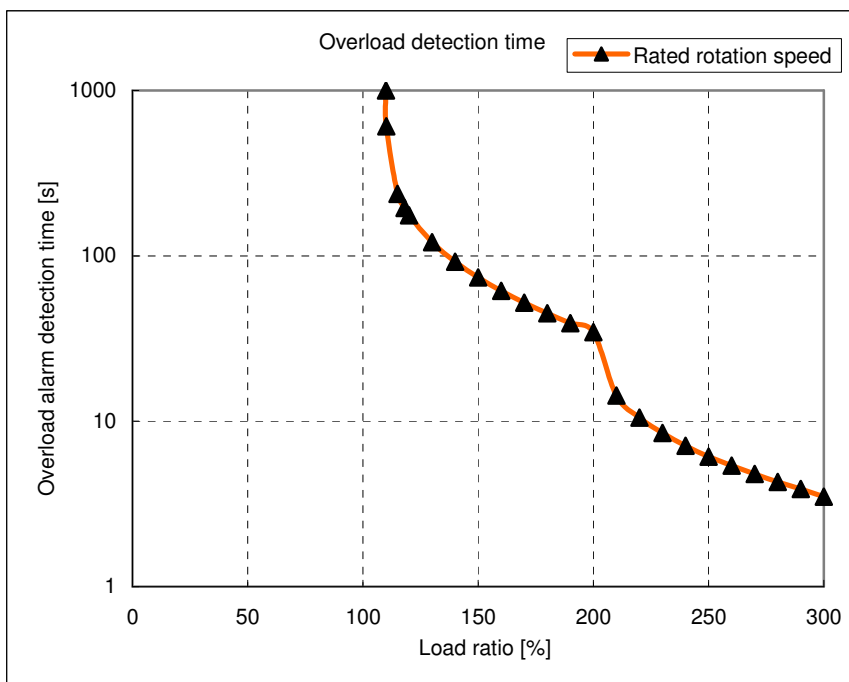

(2) Operation at maximum rotation speed (5000 r/min)

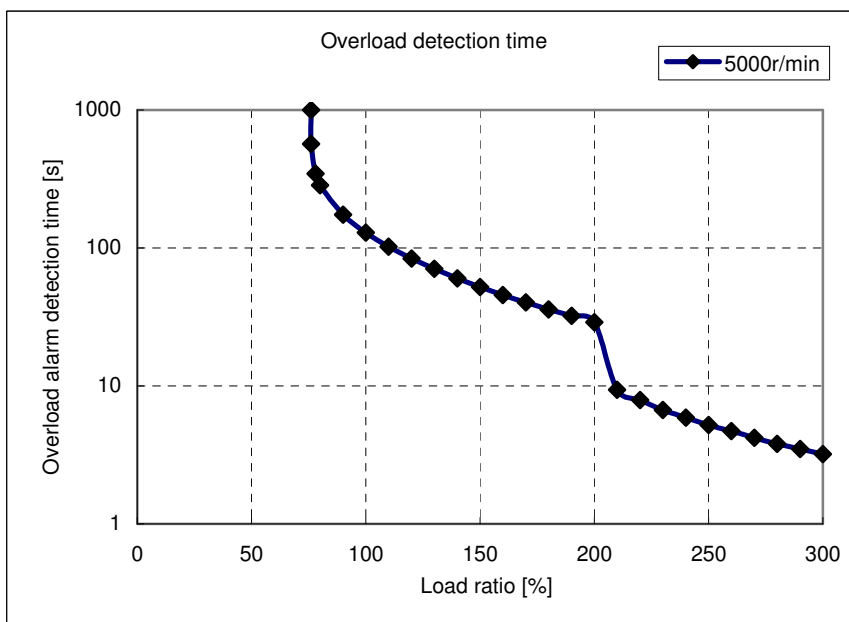

BSM (1.0-2.0 KW) motor (1) Operation at rated rotation speed (2000 r/min)

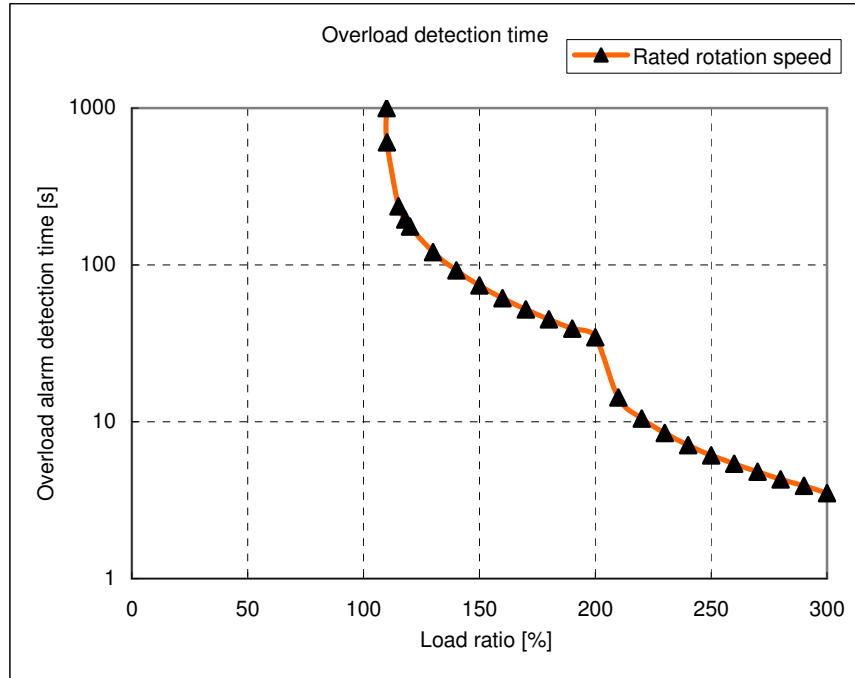

(2) Operation at maximum rotation speed (3000 r/min)

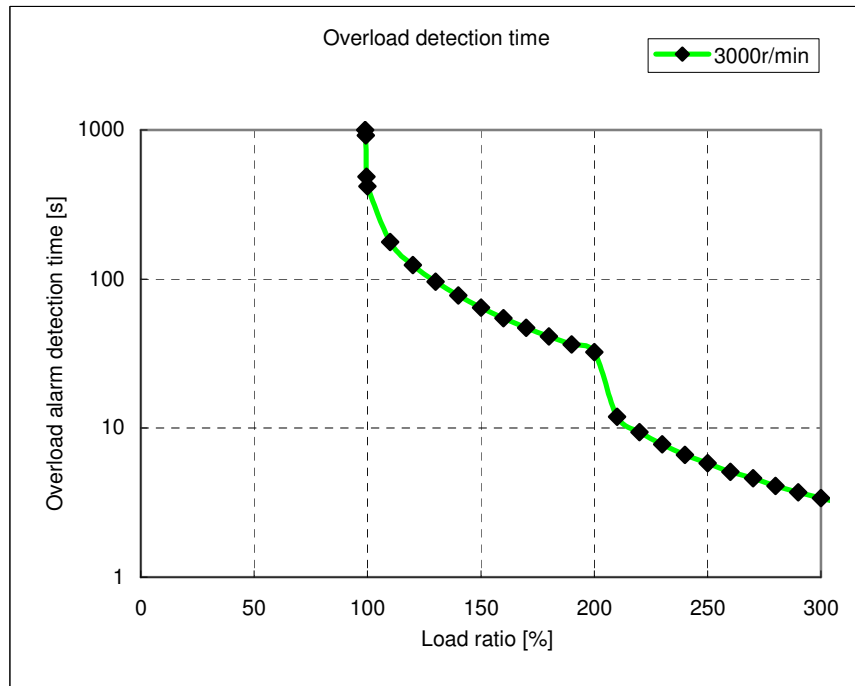

Power supply capacity and generation loss

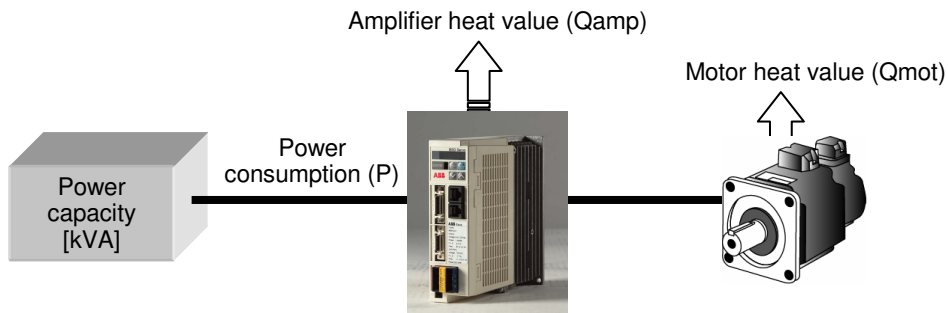

Rated rotation speed	Servo amplifier type	Servomotor type	Capacity [kW]	Power supply capacity [kVA]	Power consumption (P) [kW]	Amplifier heat value (Qamp) [kW]	Motor heat value (Qmot) [kW]
3000 [r/min]	BSD0100	BSM0100	0.1	0.2	0.13	0.021	0.011
	BSD0200	BSM0200	0.2	0.4	0.25	0.027	0.022
	BSD0400	BSM0400	0.4	0.8	0.48	0.038	0.044
	BSD0750	BSM0750	0.75	1.5	0.89	0.059	0.083
2000 [r/min]	BSD1000	BSM1000	1.0	2.0	1.2	0.073	0.11
	BSD1500	BSM1500	1.5	2.9	1.8	0.103	0.17
	BSD2000	BSM2000	2.0	3.9	2.4	0.13	0.22

Inrush current Inrush current value to the servo amplifier is shown

Rated rotation speed	Servo amplifier type	Servomotor type	Capacity [kW]	Inrush current [A]
3000 [r/min]	BSD0100	BSM0100	0.1	9.1
	BSD0200	BSM0200	0.2	9.1
	BSD0400	BSM0400	0.4	9.1
	BSD0750	BSM0750	0.75	35.7
2000 [r/min]	BSD1000	BSM1000	1.0	35.7
	BSD1500	BSM1500	1.5	43.5
	BSD2000	BSM2000	2.0	43.5

Chapter 11 – Specifications

List of servomotor specifications

Low inertia series (BSM 0.1-0.75 KW motor) 3000r/min

● Standard specifications

Motor type	BSM0100	BSM0200	BSM0400	BSM0750
Rated output [kW]	0.1	0.2	0.4	0.75
Rated torque *1 [N·m]	0.318	0.637	1.27	2.39
Max. torque [N·m]	0.955	1.91	3.82	7.17
Rated speed [r/min]	5000			
Max. speed [r/min]	5000			
Moment of inertia [kg·m ²]	0.0371 × 10 ⁻⁴	0.135 × 10 ⁻⁴	0.246 × 10 ⁻⁴	0.853 × 10 ⁻⁴
Rated current [A]	0.85	1.5	2.7	4.8
Max. current [A]	2.55	4.5	8.1	14.4
Insulation class	Class B			
Rating	Continuous rating			
Protective ventilation	Totally enclosed, self-cooling (IP 67) (except for shaft sealing and connectors)			
Terminal (Motor)	Cable 0.3 m (with connector)			
Terminal (Detector)	Cable 0.3 m (with connector)			
Overheat protection	None (Detection with servo amplifier)			
Mounting method	Flange IMB5 (L51) , IMV1 (L52) , IMV3 (L53)			
Shaft extension	Cylindrical shaft, with key			
Paint color	N1.5			
Detector	serial encoder			
Vibration	V5 or below			
Install location, altitude, Atmosphere	Indoors, altitude of 1000 m or less, place without corrosive gas, flammable gas, oil mist or dust			
Ambient temperatures and humidity	-10 to +40 °C, humidity: 90 % RH max. (free from condensation)			
Acceleration vibration, acceptable	49			
Mass [kg]	0.55	1.2	1.8	3.4

● Motor with brake (*2)

Motor type	BSM0100	BSM0200	BSM0400	BSM0750
Rated output [kW]	0.1	0.2	0.4	0.75
Rated torque *1 [N·m]	0.318	0.637	1.27	2.39
Static friction torque [N·m]		1.27		2.45
Moment of inertia [kg·m ²]	0.0402 × 10 ⁻⁴	0.335 × 10 ⁻⁴	0.446 × 10 ⁻⁴	1.203 × 10 ⁻⁴
Rated voltage [V]	35			
Attraction time [ms]	10	20		60
Release time [ms]				25
Power consumption [W]	6.1			8.5
Mass [kg]	0.7	1.7	2.3	4.2

*1) Rated torque is the value when operation is performed with the following aluminum heat sinks.

BSM (0.1-0.75 KW).....200 × 200 × 6 [mm]

BSM (0.1-0.75 KW).....250 × 250 × 6 [mm]

BSM (0.1-0.75 KW).....300 × 300 × 6 [mm]

*2) When the servomotor is operating at a low speed, a rattling noise may be heard from the brake lining. It is acceptable as to performance.

**Middle inertia series
(BSM 1.0-2.0 KW motor)
2000r/min**

● Standard specifications

Motor type		BSM1000	BSM1500	BSM2000
Rated output	[kW]	1.0	1.5	2.0
Rated torque *1	[N·m]	4.77	7.16	9.55
Max. torque	[N·m]	14.3	21.5	28.6
Rated speed	[r/min]	2000		
Max. speed	[r/min]	3000		
Moment of inertia	[kg·m ²]	15.14 × 10 ⁻⁴	22.33 × 10 ⁻⁴	29.51 × 10 ⁻⁴
Rated current	[A]	6.4	10.0	12.3
Max. current	[A]	19.2	30.0	36.9
Insulation class				
Rating	Continuous rating			
Protective ventilation	Totally enclosed, self-cooling (IP 67) (except for shaft sealing)			
Terminal (Motor)	Cannon connector			
Terminal (Detector)				
Overheat protection	None (Detection with servo amplifier)			
Mounting method	Flange IMB5 (L51) , IMV1 (L52) , IMV3 (L53)			
Shaft extension	With straight shaft key, with oil seal			
Paint color	N1.5			
Detector	Encoder			
Vibration				
Install location, altitude, Atmosph	Indoors, alt of 1000 m or less, place without corrosive gas, flammable gas, oil mist or dust			
Ambient temperatures and humidity	-10 to +40 °C, humidity: 90 % RH max. (free from condensation)			
Acceleration vibration, acceptabl	24.5			
Mass	[kg]	7.5	9.8	12.0

● Motor with brake (*2)

Motor type		BSM1000	BSM1500	BSM2000
Rated output	[kW]	1.0	1.5	2.0
Rated torque *1	[N·m]	4.77	7.16	9.55
Static friction torque	[N·m]			2.45
Moment of inertia	[kg·m ²]	17.2 × 10 ⁻⁴	24.4 × 10 ⁻⁴	31.6 × 10 ⁻⁴
Rated voltage	[V]			
Attraction time	[ms]			
Release time	[ms]			
Power consumption	[W] 20 °C)			
Mass	[kg]	9.7	12.0	14.2

*1) Rated torque is the value when operation is performed with the following aluminum heat sinks.

BSM (1.0-2.0 KW).....300 × 300 × 12 [mm]

BSM (1.0-2.0 KW).....400 × 400 × 12 [mm]

*2) When the servomotor is operating at a low speed, a rattling noise may be heard from the brake lining. It is acceptable as to performance.

Servo amplifier basic specification

**BSM (0.1-0.75 KW)
motor (3000r/min)
compatible servo
amplifier**

Amplifier type		BSD0100	BSD0200	BSD0400	BSD0750
Applicable motor output [kW]		0.1	0.2	0.4	0.75
External frame No.		Frame 1			Frame 2
Power supply	Main power	No. of phases	Single phase		
		Voltage	AC200 to 230V, -15% to +10% (Single phase: -10% to +10%)		
		Frequency	50/60Hz		
	Control power	No. of phases	Single phase		
		Voltage	AC200 to 230V -10% to +10%		
		Frequency	50/60Hz		
Control type		IGBT PWM sine wave operation			
Carrier frequency		10kHz			
Feedback		17 bit serial encoder (incremental)			
Speed fluctuation rate		±1 [r/min] or less: Load fluctuation 0 to 100%			
		±1 [r/min] or less: Load fluctuation -10% to +10%			
		±0.2% or less: Temperature fluctuation 25°C ±10%, Rated rotation speed standard (input of analog voltage)			
Speed control accuracy		1:5000 (rated load)			
Recommended load inertia moment		100 times or less for speed control of the servomotor and 30 times or less for position control.			
Overload resistance		300%/about 3 seconds			
Control function	Control type	Position control, speed control and torque control (switched with sequence input signal)			
	Position control	Pulse string			
	Speed control	Analog voltage command or internal multistep (3 step) command			
	Torque control	Analog voltage command			
	Accessory function	Brake timing output, Z phase offset, speed command zero clamp function, vibration control, command follow-up control, notch filter, etc.			
Position management	17 bit serial encoder	Dedicated to INC. The current position is lost when the power is shut off.			
Accessory function	Braking	Regenerative braking and regenerative resistance can be externally added to the DC link circuit.			
	Protection	Overcurrent (OC1, OC2), overspeed (OS), overvoltage (HV), encoder error (Et), control power error (Ct), memory error (dE), regenerative transistor overheating (rH2), encoder communication error (EC), CONT duplication (Cnt), overload (OL), undervoltage (Lv), regenerative resistor overheating (rH1), deviation limit (OF), amplifier overheating (AH)			
	Display and setting	CHARGE - Power supplied (red), 7-segment LED 4 digits and 4 operation keys			
Operating environment	Installation	Indoors, altitude of 1000 m or less, without dust, corrosive gas or direct sunlight Compatibility with European standard : Pollution Degree=2 Over Voltage Category = III			
	Ambient temperature and humidity	-10 to +55°C, 10 to 90%RH (no condensation)			
	Resistance to vibration and impact	4.9m/s ² (0.5G) · 19.6m/s ² (2G)			
Applicable standards		In accordance with UL/cUL (UL508c), in accordance with CE marking (low voltage directive EN50178)			
Weight [kg]		1.0			1.5

**BSM (1.0-2.0 KW) motor
(2000r/min) compatible
servo amplifier**

Amplifier type		BSD1000	BSD1500	BSD2000
Applicable motor output [kW]		1.0	1.5	2.0
External frame No.		Frame 2	Frame 3	
Power supply	Main power	No. of phases	Single phase/3 phase	3 phase
		Voltage	AC200 to 230V, -15% to +10% (Single phase: -10% to +10%)	
	Frequency	50/60Hz		
	Control power	No. of phases	Single phase	
Voltage		AC200 to 230V -10% to +10%		
Frequency		50 to 60Hz		
Control type		IGBT PWM sine wave operation		
Carrier frequency		10kHz		
Feedback		17 bit serial encoder (incremental)		
Speed fluctuation rate		±1 [r/min] or less: Load fluctuation 0 to 100%		
		±1 [r/min] or less: Load fluctuation -10% to +10%		
		±0.2% or less: Temperature fluctuation 25°C ±10%, Rated rotation speed standard (input of analog voltage)		
Speed control accuracy		1:5000 (rated load)		
Recommended load inertia moment		30 times or less for speed control of the servomotor and 10 times or less for position control.		
Overload resistance		300%/about 3 seconds		
Control function	Control type	Position control, speed control and torque control (switched with sequence input signal)		
	Position control	Pulse string		
	Speed control	Analog voltage command or internal multistep (3 step) command		
	Torque control	Analog voltage command		
	Accessory function	Brake timing output, Z phase offset, speed command zero clamp function, vibration control, command follow-up control, notch filter, etc.		
Position management	17 bit serial encoder	Dedicated to INC. The current position is lost when the power is shut off.		
Accessory function	Braking	Regenerative braking and regenerative resistance can be externally added to the DC link circuit.		
	Protection	Overcurrent (OC1, OC2), overspeed (OS), overvoltage (HV), encoder error (Et), control power error (Ct), memory error (dE), regenerative transistor overheating (rH2), encoder communication error (EC), CONT duplication (Cnt), overload (OL), undervoltage (Lv), regenerative resistor overheating (rH1), deviation limit (OF), amplifier overheating (AH)		
	Display and setting	CHARGE - Power supplied (red), 7-segment LED 4 digits and 4 operation keys		
Operating environment	Installation	Indoors, altitude of 1000 m or less, without dust, corrosive gas or direct sunlight Compatibility with European standard : Pollution Degree=2 Over Voltage Category = III		
	Ambient temperature and humidity	-10 to +55°C, 10 to 90%RH (no condensation)		
	Resistance to vibration and impact	4.9m/s ² (0.5G) · 19.6m/s ² (2G)		
Applicable standards		In accordance with UL/cUL (UL508c), in accordance with CE marking (low voltage directive EN50178)		
Weight [kg]		1.5	2.5	

Speed-torque characteristics

**Low inertia series (BSM
 (0.1-0.75 KW) motor)
 3000r/min**

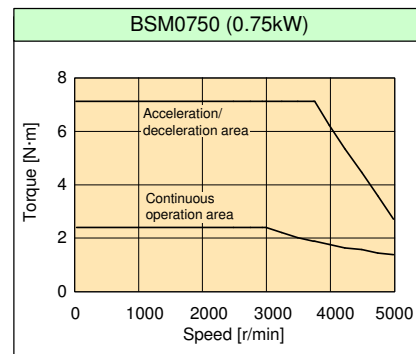
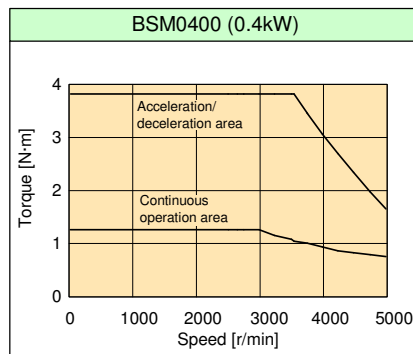
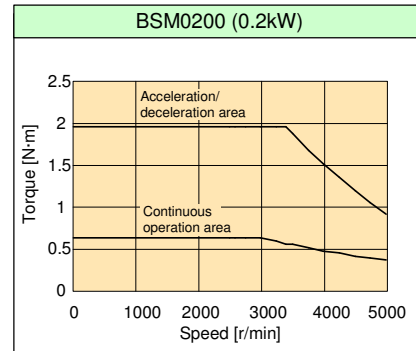
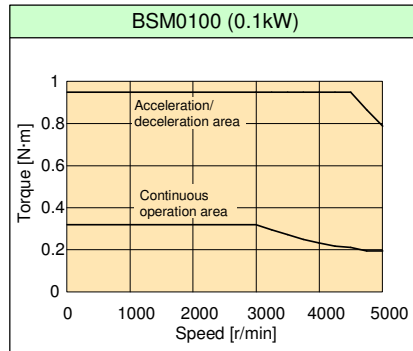

* The characteristics are indicated at 200V or more for 3 phase and at 230V or more for single phase

**Middle inertia series
(BSM (1.0-2.0 KW)
motor) 2000r/min**

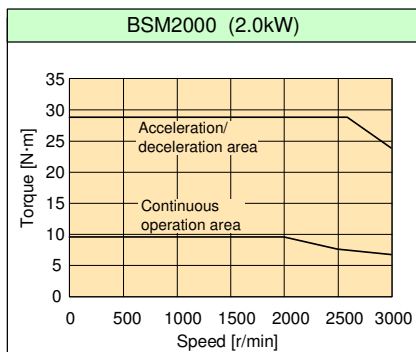
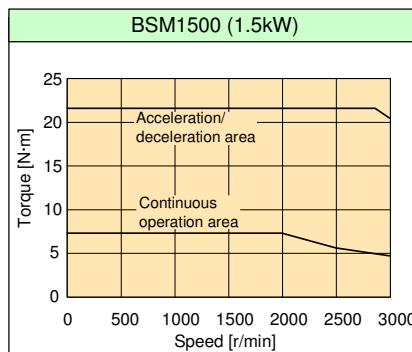
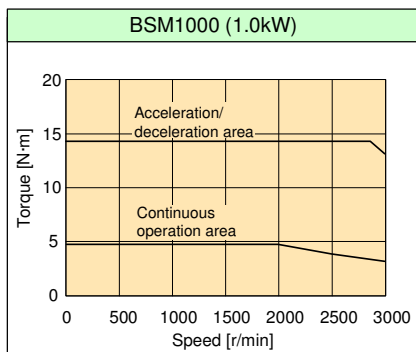

* The characteristics are indicated at 200V or more for 3 phase and at 230V or more for single phase

External Dimension

Low inertia series (BSM 0.1-0.75 KW motor) 3000r/min

■ Standard motor

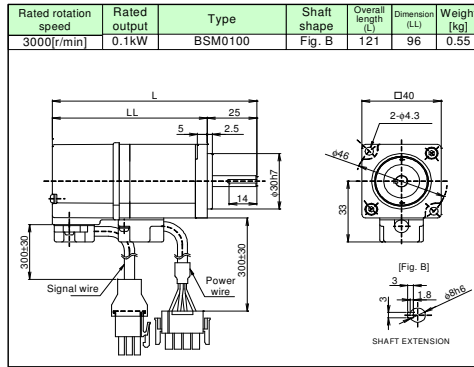

■ Motor with brake

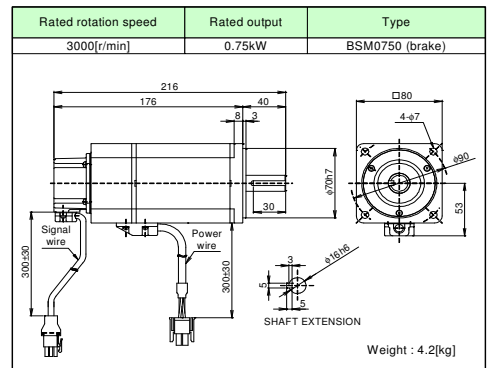
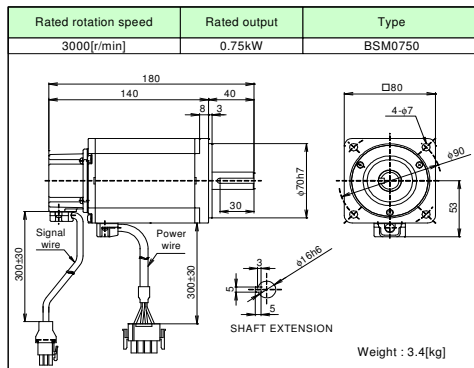
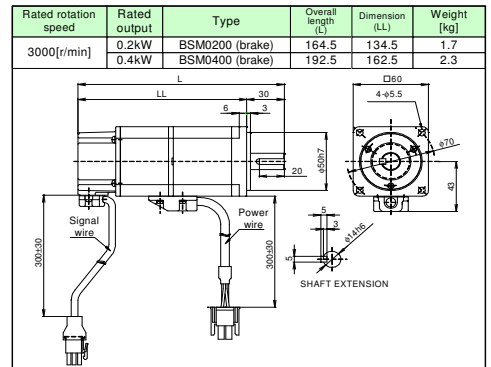
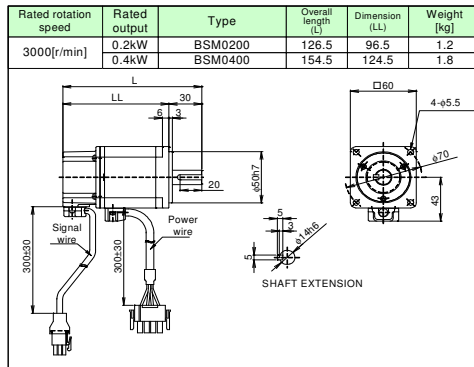
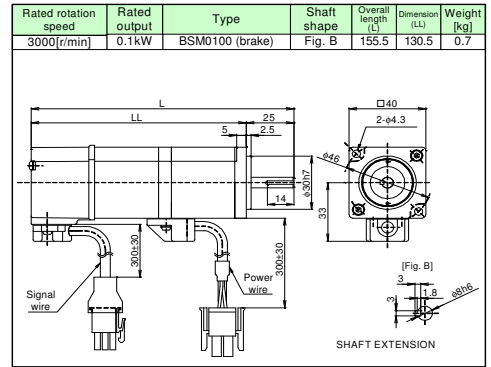

Middle inertia series (BSM 1.0-2.0 KW) motor 2000r/min

■ Standard motor

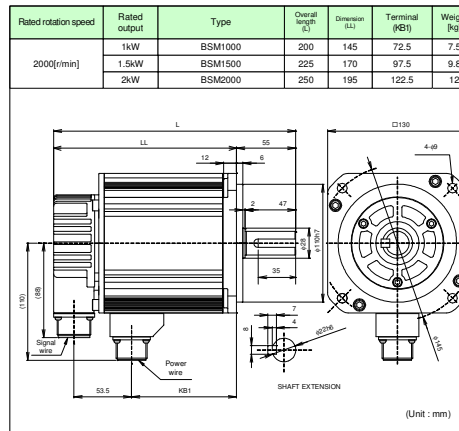

■ Motor with brake

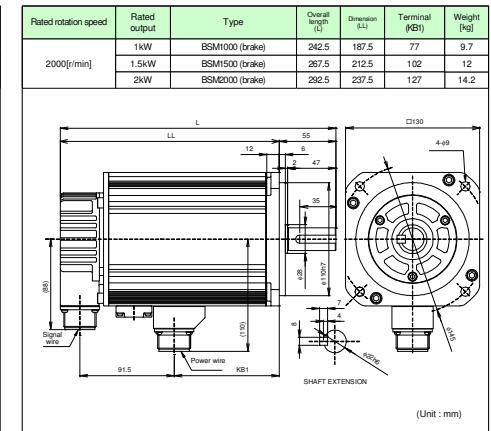

Servo amplifier

■Frame 1

Rated rotation speed	Applicable motor output	Type
3000[r/min]	0.1kW	BSD0100
	0.2kW	BSD0200
	0.4kW	BSD0400

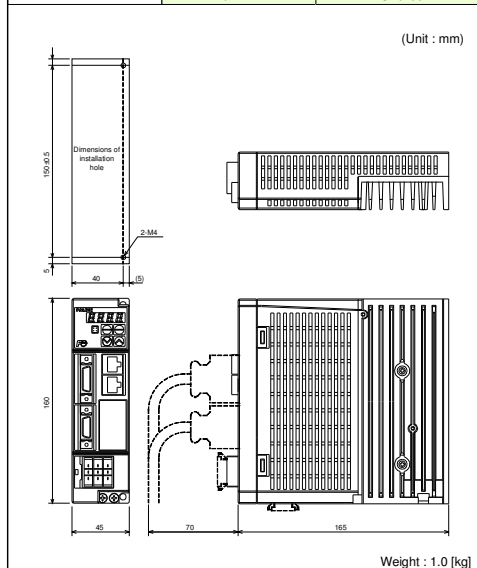

■Frame 2

Rated rotation speed	Applicable motor output	Type
3000[r/min]	0.75kW	BSD0750
2000[r/min]	1kW	BSD1000

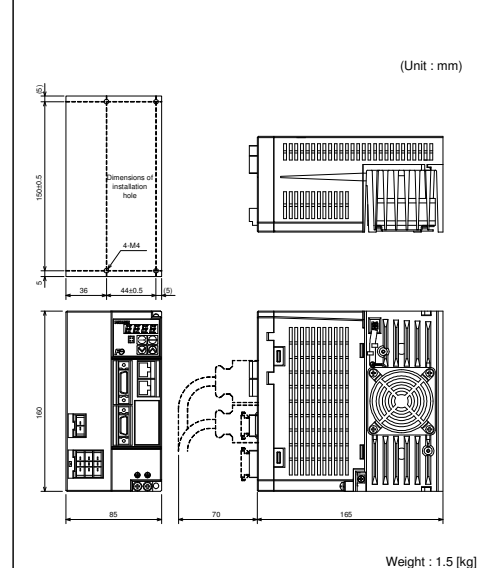

■Frame 3

Rated rotation speed	Applicable motor output	Type
2000[r/min]	1.5kW	BSD1500
	2kW	Bsd2000

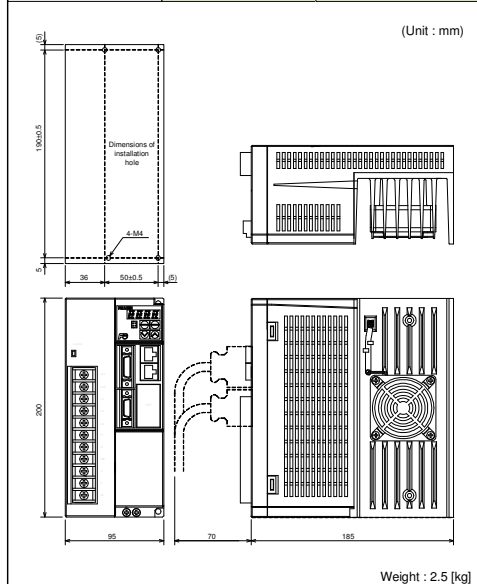

Chapter 12 – RS485 Communications

RS485 communication function

Details of the transmission command of the BSD servo amplifier are described.

The BSD servo amplifier can perform operation through the serial communication equivalent to the operation with the keypad (excluding a part of test operation mode).

Station number

The station number of the message is determined by the station number setting (parameter No. 82) of the servo amplifier.

After the parameter setting is changed, it is valid by turning the power OFF and ON again.

Sequence input terminal (CONT1 to CONT5)/sequence output terminal (OUT1 to OUT4)

The following signals are allocated to CONT1 to CONT5 terminals of connector 1 (CN1).

(Status at factory before shipment)

CN1

Terminal symbol	Initial value
CONT1	Operation command [RUN]
CONT2	Alarm reset [RST]
CONT3	-
CONT4	-
CONT5	-

CN1

Terminal symbol	Initial value
OUT1	Ready [RDY]
OUT2	Positioning end [PSET]
OUT3	Alarm detection b contact [ALMb]
OUT4	-

Response time

The operation command gives a response within approx. 5 ms. When rewriting parameters (maximum 4), the response is within approx. 20 ms.

Communication specifications

RS485 communication specifications

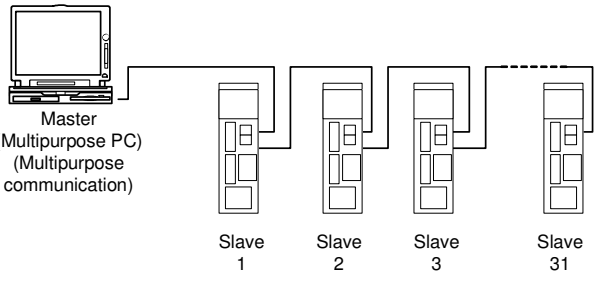
Item	Specification
Signal level	RS485
Synchronizing method	Asynchronous communication, TTY protocol
Communication method	4-wire type, half-duplex communication
Transmission speed	9600/19200/38400 bps (setting with parameter No. 83)
Transmission symbol	8 bits
Transmission configuration	Start bit: 1 bit Data bit: 8 bits Parity bit: 1 bit (even number) Stop bit: 1 bit
Transmission control	Transparent mode (There is no distinction by DLE character.)
Error control	Check sum
Transmission length	Reception: 128 bytes/Transmission: 128 bytes (maximum)
Communication type	<p>1: n communication ($1 \leq n \leq 31$)</p> <p>The servo amplifier functions as slave and only gives response for master commands. Communication between slaves is not performed.</p>  <p>The diagram illustrates a Master (Multipurpose PC) connected to a series of Slaves (Servo Amplifiers). The Master is connected to Slave 1, Slave 2, Slave 3, and Slave 31. The Slaves are connected in a daisy-chain configuration.</p>
Station No.	1 to 31 (setting with parameter No. 82)
Connection cable	LAN cable (straight) or equivalent
Termination	Master: 100 [Ω] recommended, Slave: Not required.
Response time	Operation command: 5 ms or less Data (parameter) transmission: 20 ms or less

* When 8 bits are specified as data bit, a stop bit cannot be allocated on some software.

■Transmission format

Transmission protocol

Transmission sequence	Description (All values are hexadecimal values.)	Transmission command (Upper level→Amplifier)	Reception command (Amplifier→Upper level)
①	START code	5 A	5 A
②	Data count	No. of data	No. of data
③	Fixed value for system	0 0	0 0
④	Processing status	F F	0 0
⑤	Connection method	7 B	7 B
⑥	Amplifier station No.	0 0 Fixed	0 0 Fixed
		01 (Station No.)	01 (Station No.)
⑦	Fixed value for system	1 1	1 1
		0 0	0 0
		F F	F F
		F F	F F
		F F	F F
		F F	F F
⑧	CMND	With command	With command
⑨	MODE	0 0	0 0
⑩	End information	0 0	0 0
⑪	Sequence number	0 1	0 1
⑫	Count for DATA area	No. of pieces of data in DATA area	No. of pieces of data in DATA area
⑬	Fixed value for system	0 0	0 0
⑭	DATA area	Memory type	Memory type
		Address (L)	Address (L)
		Address (M)	Address (M)
		Address (H)	Address (H)
		No. of read/write bytes	No. of read/write bytes
		0 0	0 0
		With command	STR1
			STR2
	With command		
⑮	BCC	BCC calculation value	BCC calculation value

*1: The calculation range of BCC is ② to ⑭.

*2: The calculation range of data count is ④ to ⑮.

**Description of
transmission data**

■Transmission code

Item	Description (hexadecimal)	Function
Start code	5AH (fixed)	Header code
Data count	XXH (variable)	Byte counter No. of bytes from processing status to BCC is set.
Fixed value for system	OOH (fixed) or XXH (fixed)	The value in the transmission format is set.
Processing status	00H or FFH	0xFF for request command. 0x00 for response command.
Connection method	7BH (fixed)	
Amplifier station No.	01H to 1FH (variable)	Station No. The station number to distinguish the servo amplifier is set. (1 to 31)
CMND	XXH (variable)	Command to the servo amplifier is specified.
MODE	OOH (fixed)	
End information	OOH (fixed)	
Sequence number	01H (fixed)	
Counter for DATA area	XXH (variable)	No. of bytes at DATA area is set.
DATA area	XXH (variable)	Values with each command are set.
BCC	XXH (variable)	Check sum 0x00 (Total sum of byte data from data counter to DATA area)

■ Status information (ST1, ST2)

Status information

Code	Bit position	Function	Description
ST1	7	Command not received	0: Allowed, 1: Not allowed
	6	Data error	0: No, 1: Yes
	5	Transmission error	0: No, 1: Yes
	4	Not used	0: Fixed
	3	Power ON initialization completed	0: Initialization completed, 1: Initializing
	2	ONLINE/OFFLINE	0: ONLINE, 1: OFFLINE
	1	Positioning end	0: Operating, 1: Operation completed
	0	Alarm detection	0: No, 1: Yes
ST2	7 to 0	Not used	0: Not determined (area used by manufacturer)

Bit position

ST1

7

0

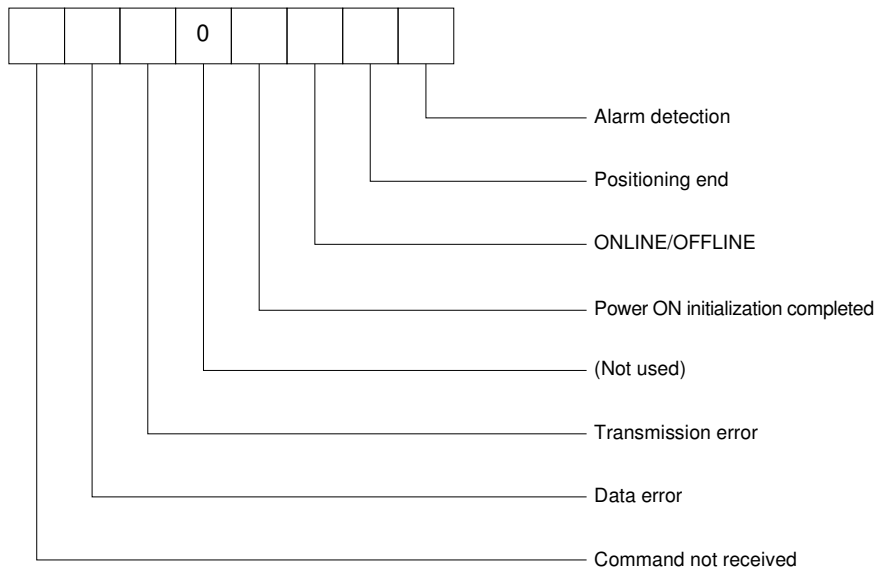

■List of commands

List of commands

No.	Function	CMND	DATA area			
			Memory type	Address (L)	Address (M)	Address (H)
Monitor						
01	Data read with multiple monitors	50 H	01 H	Monitor designated bit		00 H
Sequence monitor						
02	Sequence mode read	50 H	02 H	00 H	00 H	01 H
03	Sequence input/output signal read					02 H
04	Alarm history read					03 H
05	System status read					04 H
06	Current alarm read					07 H
Parameter edit						
07	Parameter read	50 H	03 H	Quantity (1 to 4)	Number (1 to 99)	00 H
08	Parameter write	51 H				01 H
Operation command						
09	Alarm reset	51 H	08 H	00 H	01 H	17 H
10	Alarm history initialization					23 H

Command transmission specification

The messages transmitted between the upper level system and the amplifier are classified into the following two messages:

- Request command: Message transmitted from the upper level system to the amplifier
 - Response command: Message transmitted from the amplifier to the upper level system
- Communication between amplifiers is not performed.

Communication start procedure

The amplifier does not give response for communication from the upper level system until internal initialization is completed after power supply. When the power is supplied, perform the following procedure before normal communication.

- ① After the power is supplied, wait for approx. 1.5 [s].
- ② Issue the "Status communication check" command from the upper level system and make sure that there is a response from the amplifier. At this time, check if "Power ON initialization completion (3rd bit)" is 0 (= OFF) with the "Status information (STR1)" in the response data. When this bit is 1 (= ON), it is under initialization.

Normal communication procedure

- ① The upper level system transmits the request command to the amplifier.
- ② After reception of the request command, the amplifier performs the requested command processing and transmits the response command.
The upper level system should confirm the response command before transmitting the next request command. The request commands should not be continuously transmitted without confirmation of the response command.
- ③ Other than the processing in ②, the amplifier is always waiting for commands from the upper level system.

<Procedure for error to improve reliability (Example)>

① Transmission error of physical or character level (detection by amplifier)
If a physical or character level (e.g. parity error) transmission error occurs during reception of the request command from the upper level system, the amplifier does not return the response command (no response).

If there is no response from the amplifier, the upper level system should send the same request command.

- The timer start timing for no response judgment time (timeout) is completion of the request command transmission.

- Set the timeout time as follows according to the transmission speed:

38400 [bps] : 100 [ms] or more

19200 [bps] : 200 [ms] or more

9600 [bps] : 500 [ms] or more

- Several retry counts, depending on the application, are recommended.

② Transmission error of physical or character level (detection by upper level system)

If a physical or character level transmission error occurs during reception of the response command from the amplifier, it is recommended that the upper level system should send the same request command.

- Set the retransmission timing as follows after transmission error:

38400 [bps] : 100 [ms] or more

19200 [bps] : 200 [ms] or more

9600 [bps] : 500 [ms] or more

- Several retry counts, depending on the application, are recommended.

Protocol level error

When the protocol is incorrect (data error), the amplifier does not perform the requested command processing. Error information is notified of with "Status information (STR1)" in the response command. For details of STR1, refer to 13-1 (7) Data format details.

While the upper level application software is developed, it is recommended that error information is checked. Debug the protocol according to error information.

- Data error occurs when the request command data (header, BCC, setting range for parameter data, etc.) is incorrect. Modify the data details.
- Command not received occurs when the parameter is written with parameter write protect. Check the setting for parameter No. 29 "parameter write protect."
- Access to the memory in the amplifier is limited with LV (undervoltage). When a parameter is read/written or when an alarm history is read, the command may not be received. Check the power supply status.

Multiple monitor data read

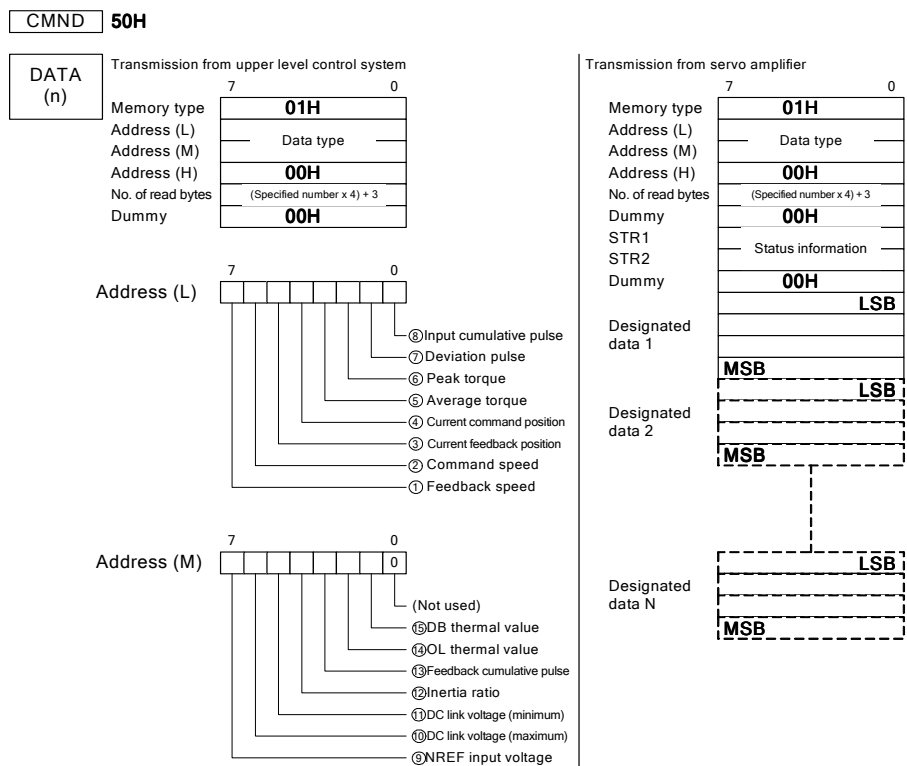

Transmit data that has 1 in address (L) and address (M) from the servo amplifier. Maximum 6 data can be designated with priority number. To obtain the current feedback position and the average torque, designate 28H to address (L).

Each piece of data is transmitted in the range of the table below with the 32 bit length fixed.

Monitor	Data (32 bit length binary fixed)	Maximum value	Priority
Feedback speed	3000 [r/min]/4000H, with ±	Maximum rotation speed x 110%	1
Command speed			2
Current feedback position	1 [pulse]/1H, with ±	-2147483648 or 2147483647	3
Current command position			4
Average torque	300 [%]/1 FFFH (rated torque 100%), with ±	300 [%]	5
Peak torque			6
Deviation pulse	1 [pulse]/1H, with ±	-2147483648 or 2147483647	7
Input cumulative pulse			8
NREF input voltage	11.2 [V]/2000H, with ±	11.2 [V]	9
DC link voltage (maximum)	510 [V]/3FFH	510 [V]	10
DC link voltage (minimum)			11
Inertia ratio	1.00 multiplied/100H (1.0 multiplied load inertia at 100H)	100.00 [multiplied]	12
Feedback cumulative pulse	1 [pulse]/1H, with ±	-2147483648 or 2147483647	13
OL thermal value	100 [%]/1000H, with ±	100 [%] = Trip level	14
DB thermal value			15

Sequence mode read

CMND 50H

DATA (n)

Transmission from upper level control system

	7	0
Memory type	02H	
Address (L)	00H	
Address (M)	00H	
Address (H)	01H	
No. of read bytes	05H	
Dummy	00H	

Transmission from servo amplifier

	7	0
Memory type	02H	
Address (L)	00H	
Address (M)	00H	
Address (H)	01H	
No. of read bytes	05H	
Dummy	00H	
STR1	— Status information —	
STR2		
Control mode		
Operation mode		
Dummy	00H	

Control mode

Data	Control mode
00H	Position control
01H	Speed control
02H	Torque control

Operation mode

Data	Operation mode
00H	Servo OFF
01H	Servo ON
02H	Zero speed stop
03H	Manual operation (JOG)
04H	Pulse string (PIN)
05H	+OT
06H	-OT
07H	Undervoltage (LV)

Sequence input/output signal read

CMND 50H

DATA (n)

Transmission from upper level control system

Memory type	02H
Address (L)	00H
Address (M)	00H
Address (H)	02H
No. of read bytes	09H
Dummy	00H

Transmission from servo amplifier

Memory type	02H
Address (L)	00H
Address (M)	00H
Address (H)	02H
No. of read bytes	09H
Dummy	00H
STR1	— Status information —
STR2	—
Input signal	—
Dummy	00H
Dummy	00H
Dummy	00H
Output signal	—
Dummy	00H
Dummy	00H

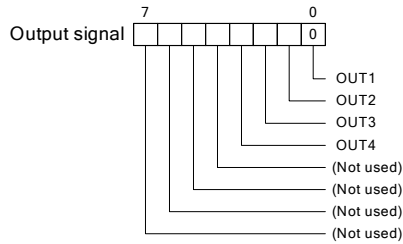
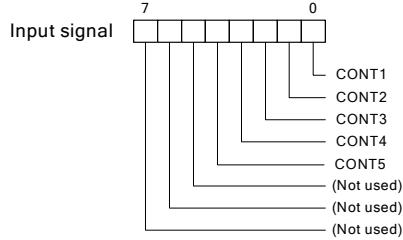

CMND 50H

DATA (n)

Transmission from upper level control system

Memory type	02H
Address (L)	00H
Address (M)	00H
Address (H)	03H
No. of read bytes	0BH
Dummy	00H

Transmission from servo amplifier

Memory type	02H
Address (L)	00H
Address (M)	00H
Address (H)	03H
No. of read bytes	0BH
Dummy	00H
STR1	— Status information —
STR2	—
ALM01	Detection of description (latest)
ALM02	Detection of description (one previous)
ALM03	Detection of description (two previous)
ALM04	Detection of description (three previous)
ALM05	Detection of description (four previous)
ALM06	Detection of description (five previous)
ALM07	Detection of description (six previous)
ALM08	Detection of description (seven previous)
ALM09	Detection of description (eight previous)

List of alarm codes

Code	Description
00H	(No detection)
01H	Overcurrent 1
02H	Overcurrent 2
03H	Overspeed
04H	Overvoltage
05H	Encoder error
06H	Control power error
08H	Memory error
0AH	Regenerative transistor overheating
0BH	Encoder communication error
0CH	CONT duplication
0DH	Overload
0EH	Undervoltage
0FH	Regenerative resistor overheating
10H	Deviation limit
11H	Amplifier overheating

Alarm history read

System status read

CMND 50H

DATA (n)

Transmission from upper level control system

Memory type	02H
Address (L)	00H
Address (M)	00H
Address (H)	04H
No. of read bytes	11H
Dummy	00H

Transmission from servo amplifier

Memory type	02H
Address (L)	00H
Address (M)	00H
Address (H)	04H
No. of read bytes	11H
Dummy	00H
STR1	Status information
STR2	
System 1	
System 2	
Model	20H
Area used by manufacturer	No fixed
ZNo.	
Area used by manufacturer	
No fixed (10byte)	

System 1

Code	Capacity [W]
01H	50
02H	100
03H	200
04H	400 or 500
05H	750 or 850
06H	1k
07H	1.3k or 1.5k
08H	2k

Input voltage

Code	Input voltage [V]
00H	200

System 2

Code	Encoder
01H	17bit INC

Motor type

Code	Motor type
01H	3000[r/min]
02H	2000[r/min]
03H	1500[r/min]

Current alarm history read

CMND 50H

DATA (n)

Transmission from upper level control system

Memory type	02H
Address (L)	00H
Address (M)	00H
Address (H)	07H
No. of read bytes	03H
Dummy	00H

Transmission from servo amplifier

Memory type	02H
Address (L)	00H
Address (M)	00H
Address (H)	07H
No. of read bytes	03H
Dummy	00H
STR1	Status information
STR2	
Current alarm	

List of alarm codes

Code	Description
00H	(No detection)
01H	Overcurrent 1
02H	Overcurrent 2
03H	Overspeed
04H	Overvoltage
05H	Encoder error
06H	Control power error
08H	Memory error
0AH	Regenerative transistor overheating
0BH	Encoder communication error
0CH	CONT duplication
0DH	Overload
0EH	Undervoltage
0FH	Regenerative resistor overheating
10H	Deviation limit
11H	Amplifier overheating

Parameter read

CMND

50H

DATA
(n)

Transmission from upper level control system

Memory type	03H
Address (L)	Quantity (01H to 04H)
Address (M)	No. (01H to 99H)
Address (H)	00H
No. of read bytes	(Designated number x 5) + 2
Dummy	00H

* Address (M) is designated with BCD.
Ex.) No. 49→49H, No. 50→50H

Transmission from servo amplifier

Memory type	03H
Address (L)	Quantity (01H to 04H)
Address (M)	Number (01H to 99H)
Address (H)	00H
No. of read bytes	(Designated number x 5) + 2
Dummy	00H
STR1	— Status information —
STR2	—

Parameter of designated number (5 bytes)

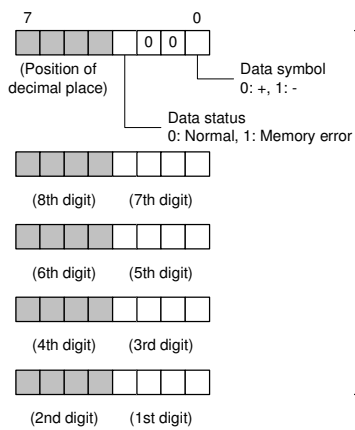

* The data is BCD 8 digits.

Parameter of designated number

Parameter of designated number + 1

Parameter of designated number + designated quantity - 1

Parameter write

CMND

50H

DATA
(n)

Transmission from upper level control system

	7	0
Memory type	03H	
Address (L)	Quantity (01H to 04H)	
Address (M)	Number (01H to 99H)	
Address (H)	01H	
No. of read bytes	(Written quantity x 5)	
Dummy	00H	
Parameter of designated number	[]	
Parameter of designated number +1	[]	
Parameter of designated number + designated quantity -1	[]	

* Address (M) is designated with BCD.
Ex.) No. 49?49H, No. 50?50H

Transmission from servo amplifier

	7	0
Memory type	03H	
Address (L)	Quantity (01H to 04H)	
Address (M)	Number (01H to 99H)	
Address (H)	01H	
No. of read bytes	(Written quantity x 5)	
Dummy	00H	
STR1	[]	
STR2	[]	

* When all data are normal, the designated quantity is written.
If an error is found, the subsequent data is not written.
Turn ON the 6th bit data error of STR1 and return the quantity actually written.

Parameter of designated number (5 bytes)

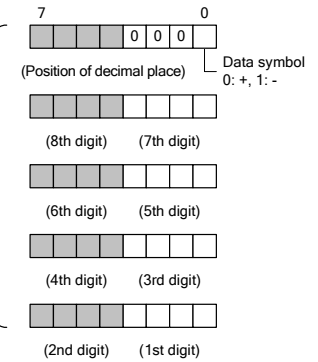

* The data is BCD 8 digits.

Alarm reset

CMND

51H

DATA
(n)

Transmission from upper level control system

	7	0
Memory type	08H	
Address (L)	00H	
Address (M)	01H	
Address (H)	17H	
No. of read bytes	00H	
Dummy	00H	

Transmission from servo amplifier

	7	0
Memory type	08H	
Address (L)	00H	
Address (M)	01H	
Address (H)	17H	
No. of read bytes	00H	
Dummy	00H	
STR1	[]	
STR2	[]	



BSD
MANIU23.0606 E

ABB Sace S.p.a.

Linea S (Servomotors & Servodrives)

Headquarters and Offices

Frazione Stazione Portacomaro, 97/C

I - 14100 Asti

ITALY

Telephone:

+39 0141 276 111

Fax: +39 0141 276 294

E-mail: sace.ssg@it.abb.com

Internet: www.abb.com

Servomotors & Servodrives

ABB Sace S.p.a.

Linea S (Servomotors & Servodrives)

Export

Via Luciano Lama, 33

I - 20090 Sesto San Giovanni (MI)

ITALY

Telephone: +39 02 2414 3562

Fax: +39 02 2414 3972

E-mail: sace.ssg@it.abb.com