

NPN SILICON TRIPLE DIFFUSED TRANSISTOR
FOR HIGH-SPEED HIGH-VOLTAGE SWITCHING

The 2SC2335 is a mold power transistor developed for high-speed high-voltage switching, and is ideal for use as a driver in devices such as switching regulators, DC/DC converters, and high-frequency power amplifiers.

FEATURES

- Low collector saturation voltage: $V_{CE(sat)} = 1.0 \text{ V MAX. @ } I_c = 3.0 \text{ A}$
- Fast switching speed: $t_r = 1.0 \mu\text{s MAX. @ } I_c = 3.0 \text{ A}$
- Wide base reverse-bias SOA: $V_{CEX(SUS)1} = 450 \text{ V MIN. @ } I_c = 3.0 \text{ A}$

ABSOLUTE MAXIMUM RATINGS ($T_A = 25^\circ\text{C}$)

Parameter	Symbol	Conditions	Ratings	Unit
Collector to base voltage	V_{CBO}		500	V
Collector to emitter voltage	V_{CEO}		400	V
Emitter to base voltage	V_{EBO}		7.0	V
Collector current (DC)	$I_{C(DC)}$		7.0	A
Collector current (pulse)	$I_{C(pulse)}$	$PW \leq 300 \mu\text{s}$, duty cycle $\leq 10\%$	15	A
Base current (DC)	$I_{B(DC)}$		3.5	A
Total power dissipation	P_T	$T_C = 25^\circ\text{C}$	40	W
		$T_A = 25^\circ\text{C}$	1.5	W
Junction temperature	T_j		150	$^\circ\text{C}$
Storage temperature	T_{stg}		-55 to +150	$^\circ\text{C}$

ORDERING INFORMATION

Part No.	Package
2SC2335	TO-220AB

(TO-220AB)

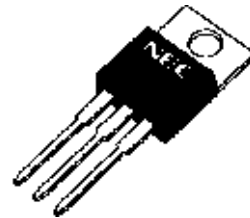

The information in this document is subject to change without notice. Before using this document, please confirm that this is the latest version.

Not all devices/types available in every country. Please check with local NEC representative for availability and additional information.

ELECTRICAL CHARACTERISTICS (T_A = 25°C)

Parameter	Symbol	Conditions	MIN.	TYP.	MAX.	Unit
Collector to emitter voltage	V _{CE0(SUS)}	I _C = 3.0 A, I _{B1} = 0.6 A, L = 1 mH	400			V
Collector to emitter voltage	V _{CEX(SUS)1}	I _C = 3.0 A, I _{B1} = -I _{B2} = 0.6 A, V _{BE(OFF)} = -5.0 V, L = 180 μH, clamped	450			V
Collector to emitter voltage	V _{CEX(SUS)2}	I _C = 6.0 A, I _{B1} = 2.0 A, -I _{B2} = 0.6 A, V _{BE(OFF)} = -5.0 V, L = 180 μH, clamped	400			V
Collector cutoff current	I _{CBO}	V _{CB} = 400 V, I _E = 0 A			10	μA
Collector cutoff current	I _{CER}	V _{CE} = 400 V, R _{BE} = 51 Ω, T _A = 125°C			1.0	mA
Collector cutoff current	I _{CEx1}	V _{CE} = 400 V, V _{BE(OFF)} = -1.5 V			10	μA
Collector cutoff current	I _{CEx2}	V _{CE} = 400 V, V _{BE(OFF)} = -1.5 V, T _A = 125°C			1.0	mA
Emitter cutoff current	I _{EBO}	V _{EB} = 5.0 V, I _C = 0 A			10	μA
DC current gain	h _{FE1}	V _{CE} = 5.0 V, I _C = 0.1 A ^{Note}	20		80	
DC current gain	h _{FE2}	V _{CE} = 5.0 V, I _C = 1.0 A ^{Note}	20		80	
DC current gain	h _{FE3}	V _{CE} = 5.0 V, I _C = 3.0 A ^{Note}	10			
Collector saturation voltage	V _{CE(sat)}	I _C = 3.0 A, I _B = 0.6 A ^{Note}			1.0	V
Base saturation voltage	V _{BE(sat)}	I _C = 3.0 A, I _B = 0.6 A ^{Note}			1.2	V
Turn-on time	t _{on}	I _C = 3.0 A, R _L = 50 Ω, I _{B1} = -I _{B2} = 0.6 A, V _{CC} ≅ 150 V			1.0	μs
Storage time	t _{stg}	Refer to the test circuit.			2.5	μs
Fall time	t _f				1.0	μs

Note Pulse test PW ≤ 350 μs, duty cycle ≤ 2%

h_{FE} CLASSIFICATION

Marking	M	L	K
h _{FE2}	20 to 40	30 to 60	40 to 80

SWITCHING TIME (t_{on}, t_{stg}, t_f) TEST CIRCUIT

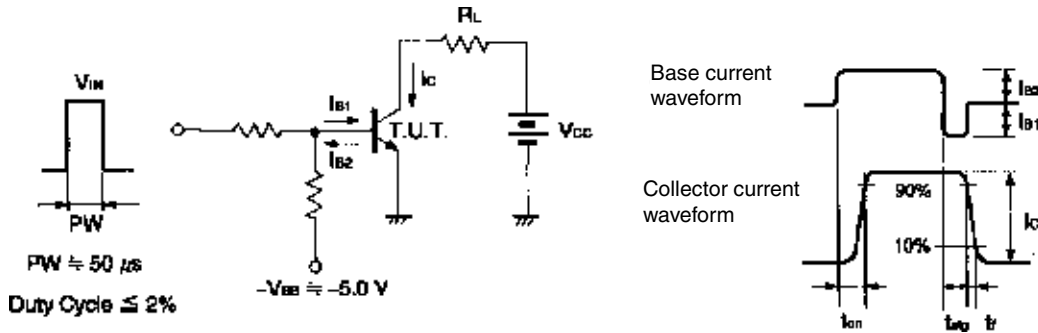

TYPICAL CHARACTERISTICS (T_A = 25°C)

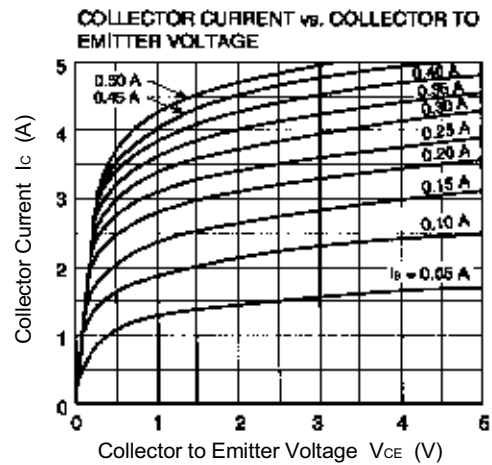
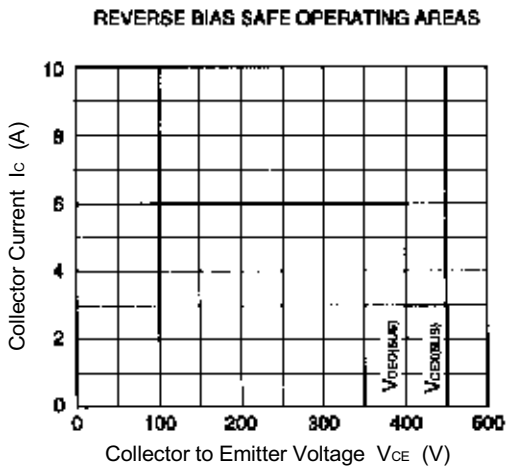
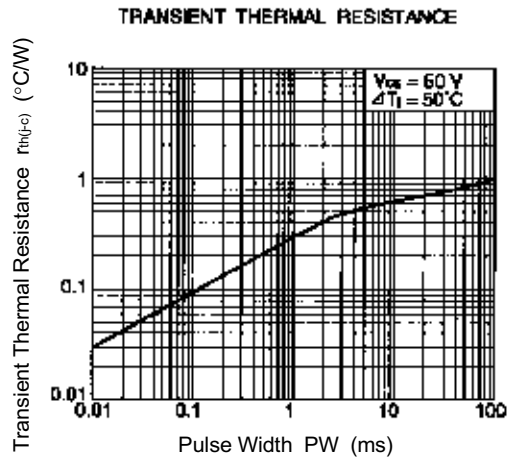
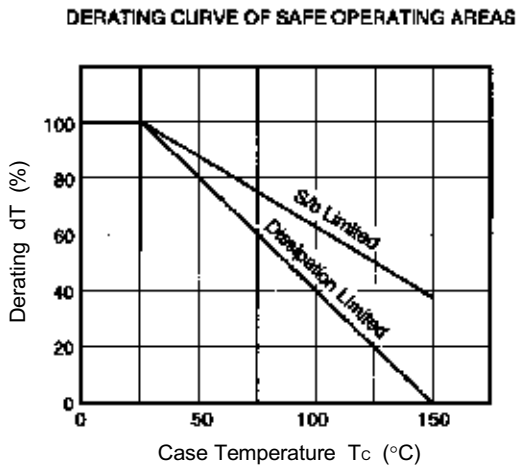
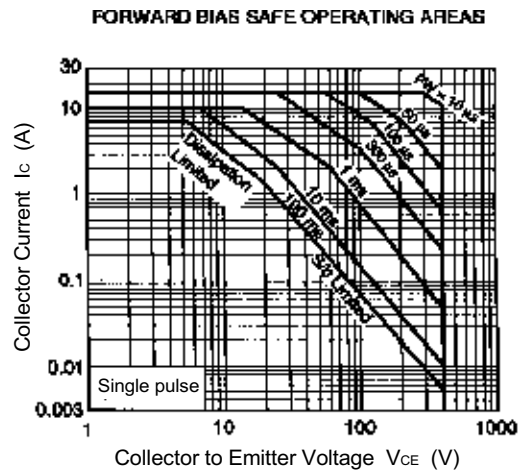
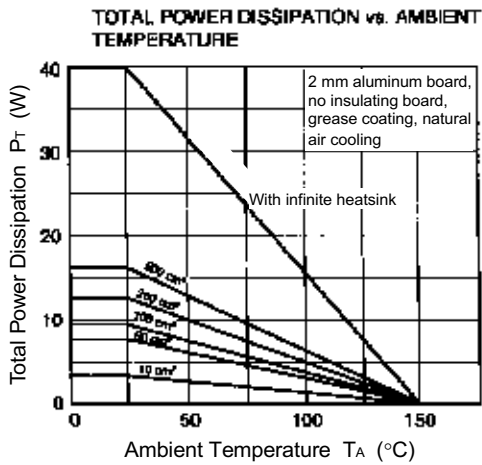

DC CURRENT GAIN vs. COLLECTOR CURRENT

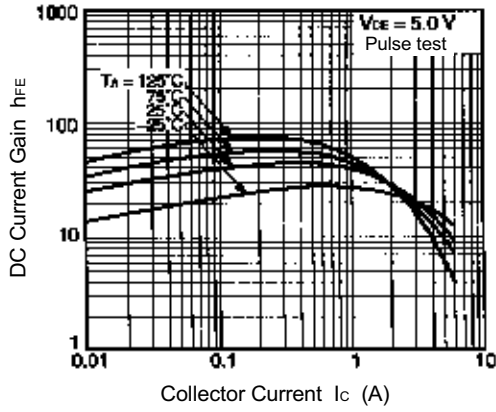

BASE AND COLLECTOR SATURATION VOLTAGE vs. COLLECTOR CURRENT

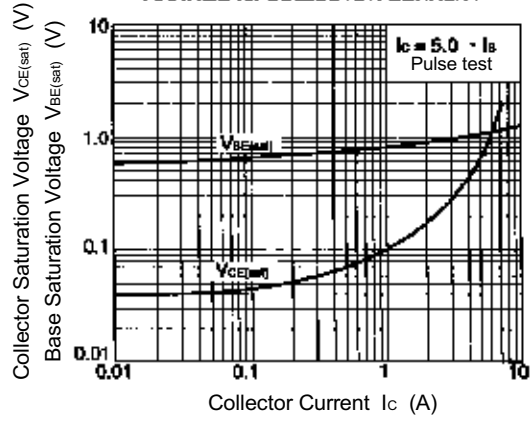

TURN ON TIME, STORAGE TIME AND FALL TIME vs. COLLECTOR CURRENT

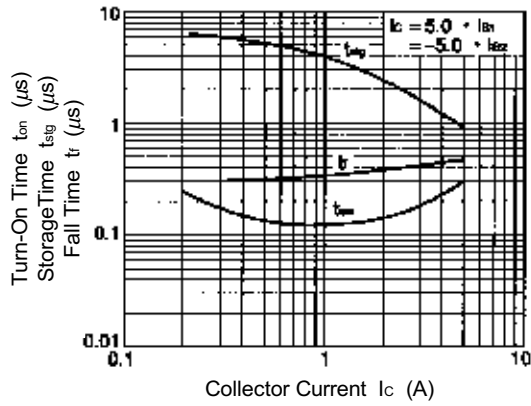

PACKAGE DRAWING (UNIT: mm)

TO-220AB (MP-25)

