

ECAT-2093

EtherCAT Three-Channel Incremental Encoder Counter

User Manual (Version 1.1)





WARRANTY

All products manufactured by ICP DAS are warranted against defective materials for a period of one year from the date of delivery to the original purchaser.

WARNING

ICP DAS assumes no liability for damages consequent to the use of this product. ICP DAS reserves the right to change this manual at any time without notice. The information furnished by ICP DAS is believed to be accurate and reliable. However, no responsibility is assumed by ICP DAS for its use, nor for any infringements of patents or other rights of third parties resulting from its use.

COPYRIGHT

Copyright © 2018 by ICP DAS. All rights are reserved.

TRADEMARK

Names are used for identification only and may be registered trademarks of their respective companies.

CONTACT US

If you have any questions, please feel free to contact us via email at:
service@icpdas.com
service.icpdas@gmail.com

Revision

Revision	Date	Description	Author
1	23.05.2018	Initial version	M. K.
1.1	25.10.2018	Change object name ending from "_Chx_" to "Ch.x"	M. K.

Contents

1	Product Overview.....	3
1.1	Introduction.....	3
1.2	Technical Data.....	3
1.3	Specification.....	4
1.4	Dimensions.....	6
2	Scope of Delivery.....	7
3	LED Definition.....	8
4	Wiring.....	10
4.1	Connection Interfaces.....	10
4.2	Encoder Connection.....	12
5	Basics Communication.....	15
5.1	EtherCAT Cabling.....	15
5.2	EtherCAT State Machine.....	15
5.3	Synchronization Modes.....	17
5.3.1	Free Run Mode.....	17
5.3.2	SM-Synchron.....	19
5.3.3	Distributed Clocks (DC Mode).....	20
6	Project Integration.....	23
6.1	ESI File.....	23
6.1.1	Import of ESI File.....	23
6.2	Device Setup and Configuration.....	23
6.2.1	Scanning of the EtherCAT Device.....	24
6.2.2	Encoder Counter Configuration.....	25
6.2.3	EtherCAT Slave Process Data Assignment.....	27
7	Parameter Description.....	29
7.1	Counting Mode.....	29
7.2	Signal Polarity Setting.....	31
7.3	Low Pass Filter Setting.....	32
7.4	Encoder Status.....	33
7.5	Encoder Outputs.....	33
8	CoE Interface.....	35
8.1	General Description.....	35
8.2	Save Configuration Data to Memory.....	36
9	Object Description and Parameterization.....	40
9.1	Standard Objects.....	40
9.2	RxPDO Mapping Objects.....	41
9.3	TxPDO Mapping Objects.....	41
9.4	Sync Manager Objects.....	42
9.5	Input Data.....	45
9.6	Output Data.....	46
9.7	Configuration Data.....	47

9.8 Configuration Parameters Storage.....48

1 Product Overview



1.1 Introduction

The EtherCAT slave ECAT-2093 is an incremental encoder counter which provides three independent high-speed counter channels. It reads the pulse train generated by an incremental encoder and can be used in positioning feedback applications. Each channel has two counter inputs. The inputs can either be single-ended or differential signals. Three counting modes are supported: clockwise/counterclockwise, pulse/direction and quadrant counting mode. The hardware index latch function allows the latching of encoder position. Low pass filter functions for filtering out electrical noises are provided.

1.2 Technical Data

Features:

- EtherCAT slave
- Three channels, 32-bit incremental encoder counters
- Encoder counting mode: CW/CCW , Pulse/Direction, A/B Phase
- Maximum counting rate: 4 MHz
- Encoder Input: A, B, Z differential or single-ended signals
- Index latch counter value
- Digital input filter
- Input level: 5V, 12V/24V with internal resistor
- Polarity setting by software for active high or active low encoder input
- A/B/Z signal isolation voltage: 2500V optical isolation

1.3 Specification

- **Encoder input specification:**
 - Parallel I/O Module:
3-Channel, 32 bits encoder counter.
 - Encoder Mode:
 - CW/CCW mode
 - Pulse/Dir mode
 - Quadrant mode
 - Maximum Counting Rate:
 - CW/CCW mode 4M pulse/sec
 - Pulse/Dir mode 4M pulse/sec
 - Quadrant mode 4M pulse/sec
 - Input Level:
 - Input level 5 V
 - Logic high: 4 V ~ 5 V
 - Logic low: 0 V ~ 2 V
 - Input 12 V with internal resistor 1 K ohm
 - Logic high: 5 V ~ 12 V
 - Logic low: 0 V ~ 2 V
 - Input 24V with internal resistor 1K ohm
 - Logic high: 5 V ~ 24 V
 - Logic low: 0 V ~ 2 V
- **EtherCAT specification:**
 - 2 x RJ-45 bus interface
 - Distance between stations up to 100 m (100BASE-TX)
 - Support daisy chain connection
 - EtherCAT conformance test tool verified
 - Supports Free-Run, SM synchron and Distributed Clock (DC) operation modes
- **LED indicators for EtherCAT and encoder status**

Item	Specification
Encoder	
Number of encoder inputs	3x encoder counter (A, B, Z), differential or single-ended
Resolution	32 bit
Maximum input pulse frequency	4 MHz
Input level:	<ul style="list-style-type: none"> • 5V (default) • 12V/24V with internal resistor (set by jumper)
Photo-Isolation	2500 V _{DC}
LED Indicators	
Diagnostic LED	Power, EtherCAT status, signal status of each encoder input
Communication Interface	
Connector	2 x RJ-45
Protocol	EtherCAT
Distance between stations	Max. 100 m (100BASE-TX)
Data transfer medium	Ethernet/EtherCAT Cable (Min. CAT 5), Shielded
Power	
Input voltage range	20 V _{DC} ~ 30V _{DC}
Power consumption	Maximum 4.5W
EMS Protection	
ESD (IEC 61000-4-2)	4 KV Contact for each channel
EFT (IEC 61000-4-4)	Signal: 1 KV Class A; Power: 1 KV Class A
Surge (IEC 61000-4-5)	1 KV Class A
Mechanism	
Installation	DIN-Rail
Dimensions (LxWxH) [mm]	110mm x 90mm x 33mm (without connectors)
Case material	UL 94V-0 housing
Environment	
Operating temperature	-25°C ~ 70°C
Storage temperature	-30°C ~ 80°C
Relative humidity	10 ~ 90%, No condensation

Table 1: Technical data

1.4 Dimensions

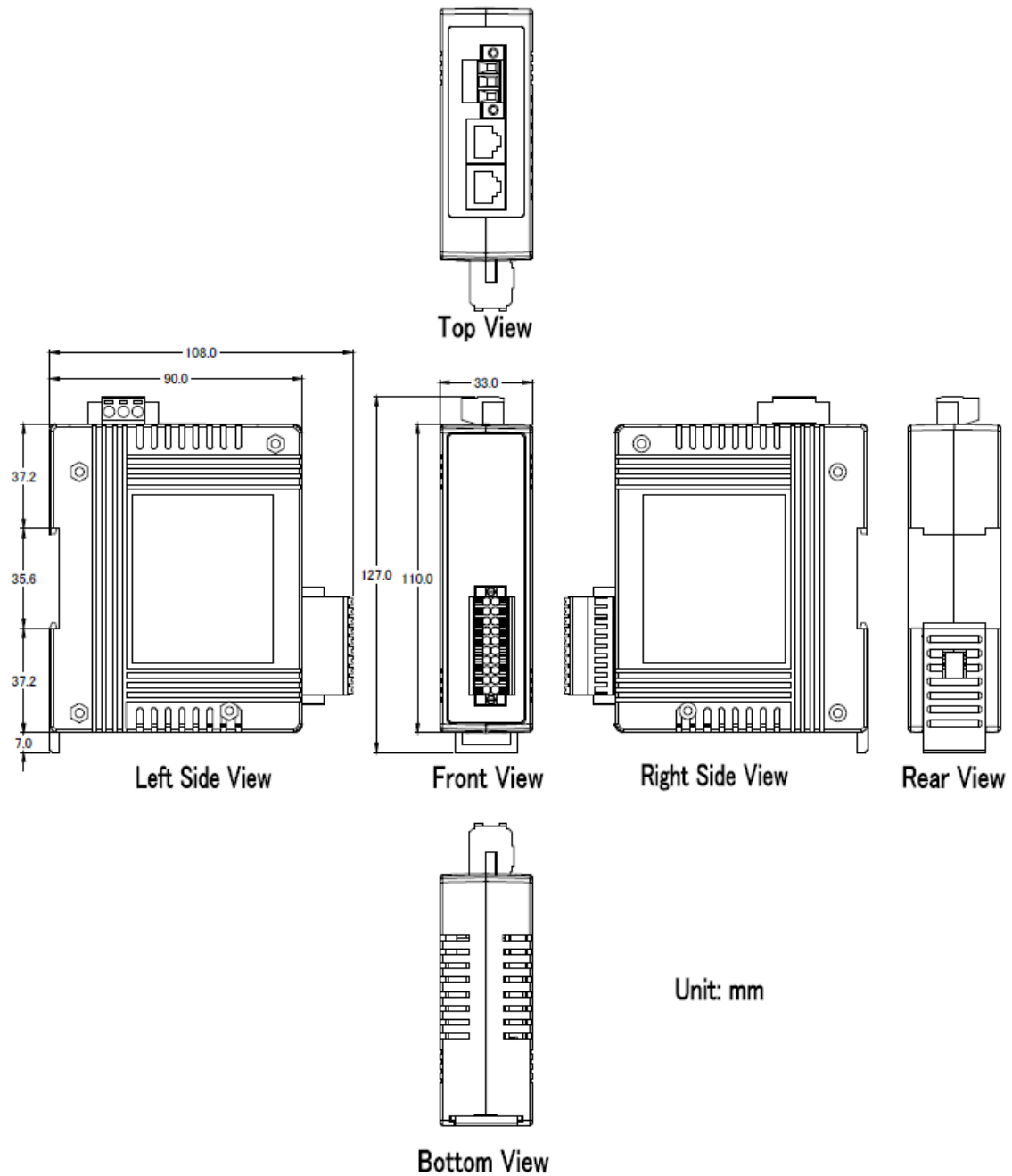

Figure 1: Dimensions of the ECAT-2093

2 Scope of Delivery

The shipping package includes the following items:

- 1 x ECAT-2093
- 1 x 20-pin plug-in connector
- 1 x 3-pin plug in connector (for power supply)
- 1 x Quick Start manual



Figure 2: ECAT-2093 module and Quick Start manual

Note:

If any of these items are missing or damaged, please contact your local distributor. Please keep the original retail box with all retail packaging (Styrofoam, inner boxes, fasteners, etc.) in case you need to return the product.

More Information:

- Product website:
http://www.icpdas.com/root/product/solutions/industrial_communication/fieldbus/thercat/motion/ecat-2093.html
- Manual:
ftp://ftp.icpdas.com/pub/cd/fieldbus_cd/ethercat/slave/motion/ecat-2093/manual/
- XML EtherCAT Slave Information (ESI) file:
ftp://ftp.icpdas.com/pub/cd/fieldbus_cd/ethercat/slave/motion/ecat-2093/esi/
- FAQ:
http://www.icpdas.com/root/product/solutions/industrial_communication/fieldbus/thercat/ethercat_faqs.html
- Technical support:
service@icpdas.com

3 LED Definition

The ECAT-2093 provides on the front side several diagnostic LEDs which indicates the signal status of each encoder channel.

Furthermore there are three LEDs to show the EtherCAT network status. The exact meaning of each LED is described in the following tables:

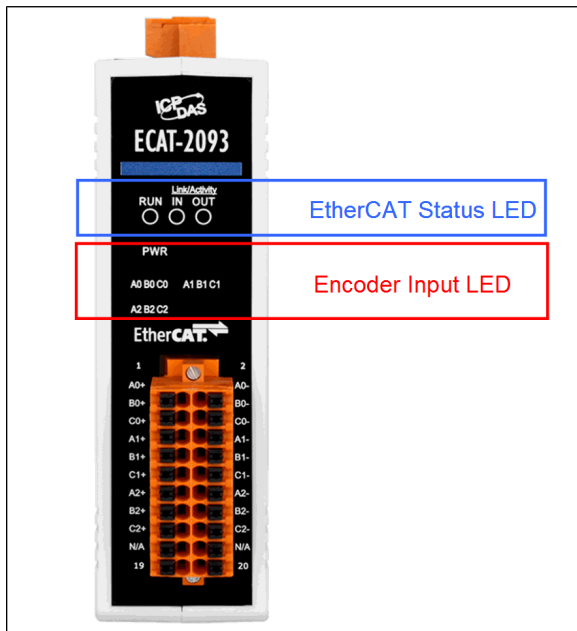

Figure 3: ECAT-2093 LEDs

EtherCAT LED	Color	State	Description
RUN	red		This LED indicates the operation state of the EtherCAT slave:
		Off	Device is in INIT state
		Flashing	Device is in PREOP state
		Single flash	Device is in SAFEOP state Outputs remain in safe state
		On	Device is in OP state
IN	green		Indicates the communication status of the EtherCAT port IN
		Off	No connection
		Flashing	Link and activity (e.g. data exchange with the master)
OUT	green	On	Link without any activity
		Off	Indicates the communication status of the EtherCAT port OUT. Further EtherCAT slave can be connected to the port OUT No EtherCAT slaves are connected to port OUT

		Flashing	Link and activity (e.g. data exchange connected slaves)
		On	Link without any activity

Table 2: EtherCAT status indicator

Control LED	Color	Description
*	red	- Power indicator
***** (first row) 0 1 2 3 4 5 6 7	green	- LED 0: A0 channel status - LED 1: B0 channel status - LED 2: C0 channel status - LED 3: reserved - LED 4: A1 channel status - LED 5: B1 channel status - LED 6: C1 channel status - LED 7: reserved
***** (second row) 8 9 10 11 12 13 14 15	green	- LED 8: A2 channel status - LED 9: B2 channel status - LED 10: C2 channel status - LED 11: reserved - LED 12: reserved - LED 13: reserved - LED 14: reserved - LED 15: reserved

Table 3: Diagnostic LEDs

4 Wiring

4.1 Connection Interfaces

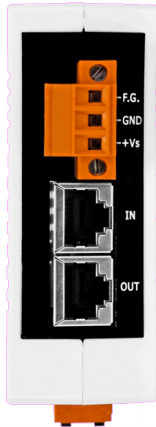

Figure 4: ECAT-2093 side view with power supply and EtherCAT connection

Name	Signal	Description
F.G	Frame ground	
GND	Power supply: Ground 0V (from negative power contact)	Feeding for ECAT-2093
+Vs	Power supply: +24 V _{DC} (from positive power contact)	
IN	EtherCAT signal input	Incoming EtherCAT cable
OUT	EtherCAT signal output	Outgoing EtherCAT cable

Table 4: ECAT-2093 power supply and EtherCAT interfaces



Figure 5: ECAT-2093 front view with encoder inputs

Name	Signal	Signal Description	
A0+	Input	Encoder input A0+	Encoder Channel 0
A0-	Input	Encoder input A0-	
B0+	Input	Encoder input B0+	
B0-	Input	Encoder input B0-	
Z0+	Input	Encoder input C0+	
Z0-	Input	Encoder input C0-	
A1+	Input	Encoder input A1+	Encoder Channel 1
A1-	Input	Encoder input A1-	
B1+	Input	Encoder input B1+	
B1-	Input	Encoder input B1-	
Z1+	Input	Encoder input C1+	Encoder Channel 2
Z1-	Input	Encoder input C1-	
A2+	Input	Encoder input A2+	
A2-	Input	Encoder input A2-	
B2+	Input	Encoder input B2+	
B2-	Input	Encoder input B2-	
Z2+	Input	Encoder input C2+	
Z2-	Input	Encoder input C2-	

Table 5: Connection interfaces of the encoder

4.2 Encoder Connection

The ECAT-2093 can accept encoder inputs from either differential or single-ended signals. By default it is set to support differential encoder signals as they are preferred due to their excellent noise immunity. For open collector type encoder the internal resistor needs to be enabled. The ECAT-2093 does not provide an internal power supply for the encoder therefore the encoder has to be connected to an external power supply.

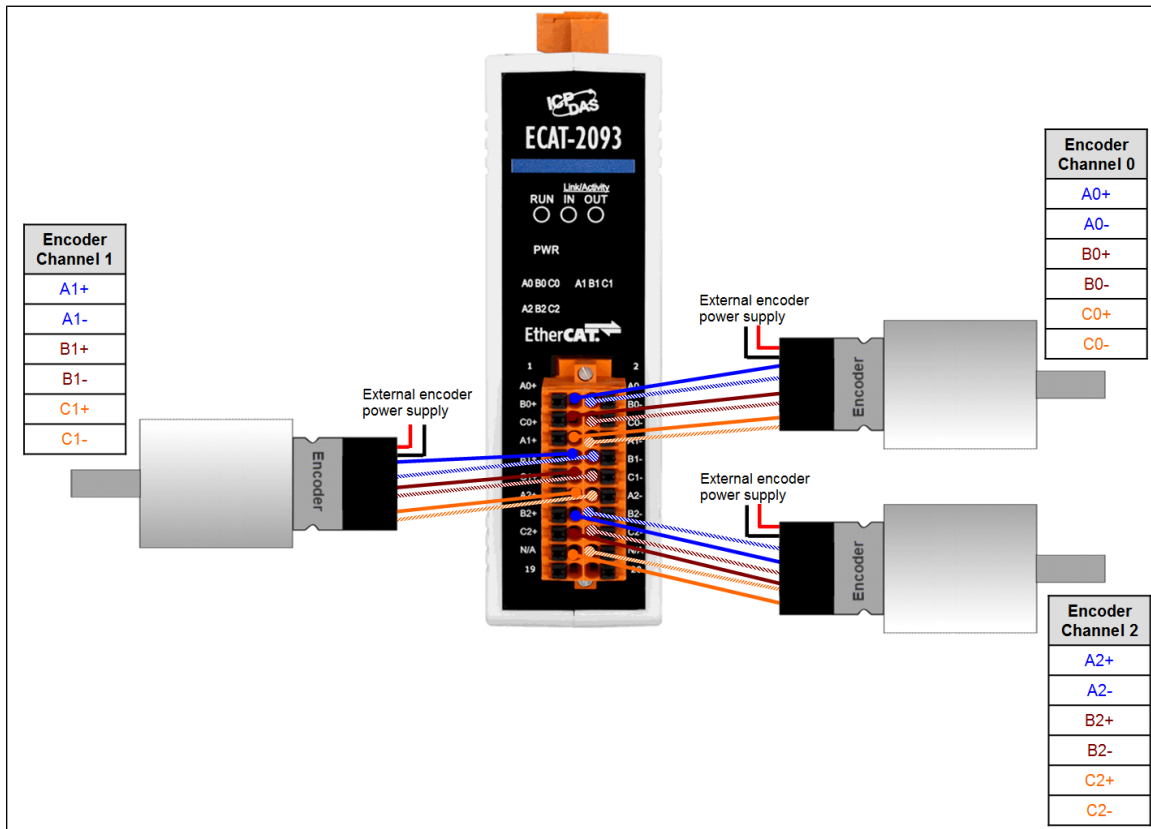

Figure 6: Differential encoder connection

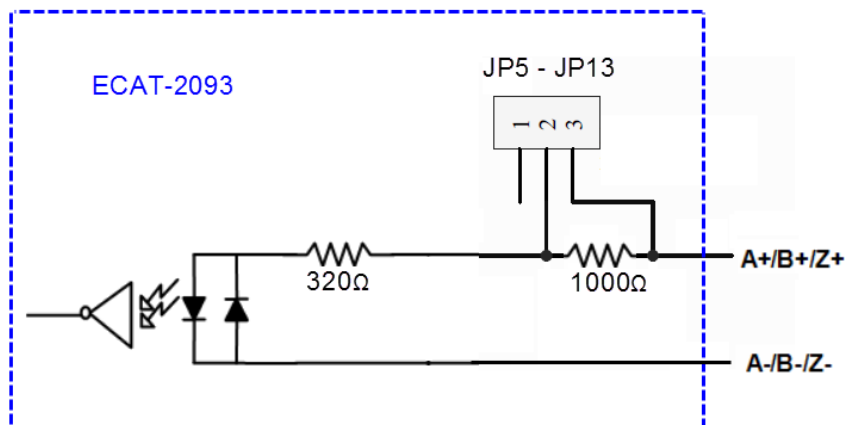

Figure 7: Encoder channel circuit

For single-ended encoder connection the ECAT-2093 provides an internal 1k Ohm resistor for each signal input. The internal resistor can be selected by setting the jumper of the corresponding encoder channel to the position 1-2. The housing needs to be opened in order to set the jumper. For enabling the internal resistor Table 6 lists for each encoder signal input the corresponding jumper position. Figure 8 shows the basic wiring diagram for open collector connection.

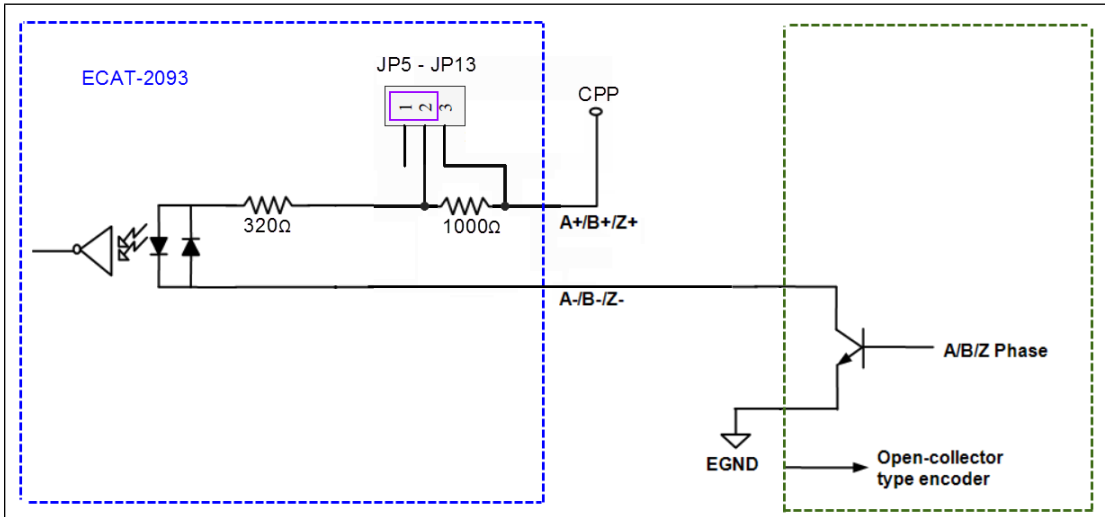

Figure 8: Open collector wiring diagram

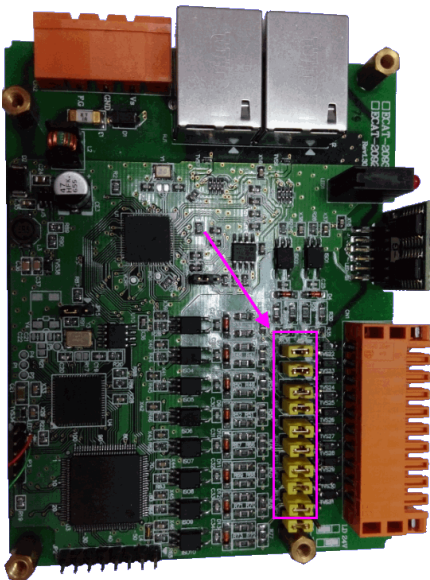

Figure 9: Jumper location

	3	2	1
JP5	■	■	■
JP6	■	■	■
JP7	■	■	■
JP8	■	■	■
JP9	■	■	■
JP10	■	■	■
JP11	■	■	■
JP12	■	■	■
JP13	■	■	■

Jumper No	Channel	Jumper position 2-3	Jumper position 1-2
JP5	Encoder input A0	Differential channel	Open collector channel

JP6	Encoder input B0	Differential channel	Open collector channel
JP7	Encoder input Z0 (C0)	Differential channel	Open collector channel
JP8	Encoder input A1	Differential channel	Open collector channel
JP9	Encoder input B1	Differential channel	Open collector channel
JP10	Encoder input Z1 (C1)	Differential channel	Open collector channel
JP11	Encoder input A2	Differential channel	Open collector channel
JP12	Encoder input B2	Differential channel	Open collector channel
JP13	Encoder input Z2 (C2)	Differential channel	Open collector channel

Table 6: Jumper definitions for the encoder channels

The input levels for the open collector with the internal resistor of 1 K ohm is as follows

- Input 12 V:
 - Logic High: 5 V ~ 12 V
 - Logic Low: 0 V ~ 2 V
- Input 24V:
 - Logic High: 5 V ~ 24 V
 - Logic Low: 0 V ~ 2 V

5 Basics Communication

5.1 EtherCAT Cabling

The cable length between two EtherCAT devices must not exceed 100 m.

Cables and connectors

For connecting EtherCAT devices only Ethernet connections (cables + plugs) that meet the requirements of at least category 5 (CAT5) according to EN 50173 or ISO/IEC 11801 should be used. EtherCAT uses 4 wires for signal transfer.

The pin assignment is compatible with the Ethernet standard (ISO/IEC 8802-3).

5.2 EtherCAT State Machine

The state of the EtherCAT master and slave is controlled via the EtherCAT State Machine (ESM). The state determines which functions are accessible or executable in the EtherCAT slave. State changes are typically initiated by requests of the master and acknowledged by the slave after the successful initialization. In case of an internal error, the slave automatically changes to a lower state.

The ECAT-2093 supports four states:

- Init (state after Reset)
- Pre-Operational
- Safe-Operational
- Operational

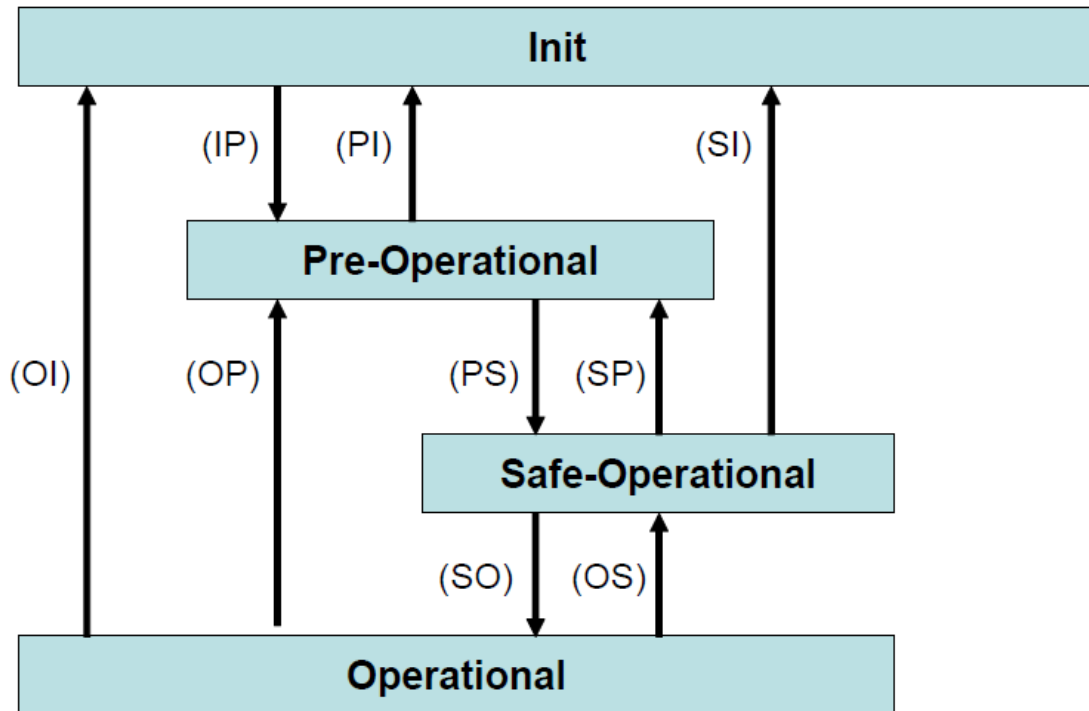

Figure 10: EtherCAT state machine

Init

After switch-on the EtherCAT slave is in the initial state. Only ESC register communication is possible, but no mailbox or process data communication. The slave initializes the service object data with default value or with values previously stored to the local memory. The EtherCAT master assigns the station address and configures the sync manager channels 0 and 1 for acyclic mailbox communication.

Pre-Operational (Pre-Op)

In Pre-Op state acyclic mailbox communication is possible, but not process data communication. In this state the EtherCAT master does the following configurations:

- Set the sync manager 2 and 3 of the ECAT-2093 for process data communication (from sync manager channel 2)
- The FMMU channels
- PDO mapping or the sync manager PDO assignment
- The user has the option to save motion control related configuration data (0x8000-0x8020) to a non-volatile memory.

Safe-Operational (Safe-Op)

In Safe-Op state both mailbox and process data communication are enabled, but the slave keeps its outputs in a safe state, while the input data are updated cyclically. The slave will ignore the output data sent by the master and just return the current input

data (e.g. digital input, encoder value, etc.)

The sync manager watchdog expires when the master application does not provide new output process data within the configured watchdog time. In this case the slave will automatically go from operational state to ERROR-SAFEOP state.

Operational (Op)

Here both the process data object (PDO) and service data object (SDO) are fully enabled. Master sends cyclic output data and read input data. The ECAT-2093 supports three type of Op modes: Free Run mode, SM-Synchron and Distributed Clock (DC) mode.

5.3 Synchronization Modes

ECAT-2093 devices support three different modes:

- Free Run: The master cycle time and slave cycle time are independent and not synchronized.
- SM-Synchron: The master cycle time interval is not deterministic and can vary. Master and slave process data handling are synchronized. The slave only starts processing data once it received a new datagram from the master.
- Distributed Clock (DC): The cycle time and interval is fixed and deterministic. Both the master and slave cycle time are synchronized. The slave processes data at a fixed and deterministic time interval (DC cycle time). The slave expect the master to exchange process data at a fixed time interval. If the master does not send/read data within the set time interval then an synchronization error will be generated by the slave.

5.3.1 Free Run Mode

The slave operates autonomously based on its own cycle and is not synchronized with the EtherCAT cycle. The master cycle time and the slave cycle time are fully independent which means each slave device reads/writes its own process data according to its local time, independent of the master's cycle time.

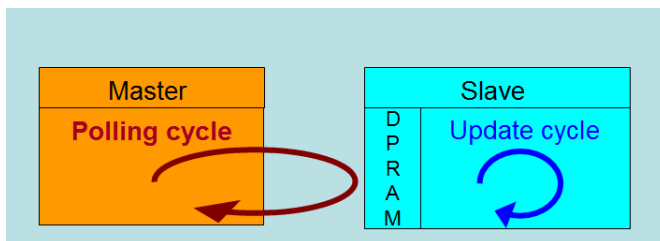

Figure 11: Master-slave cycle in Free Run mode

The following diagram shows the process timing of the slave in Free Run mode in detail:

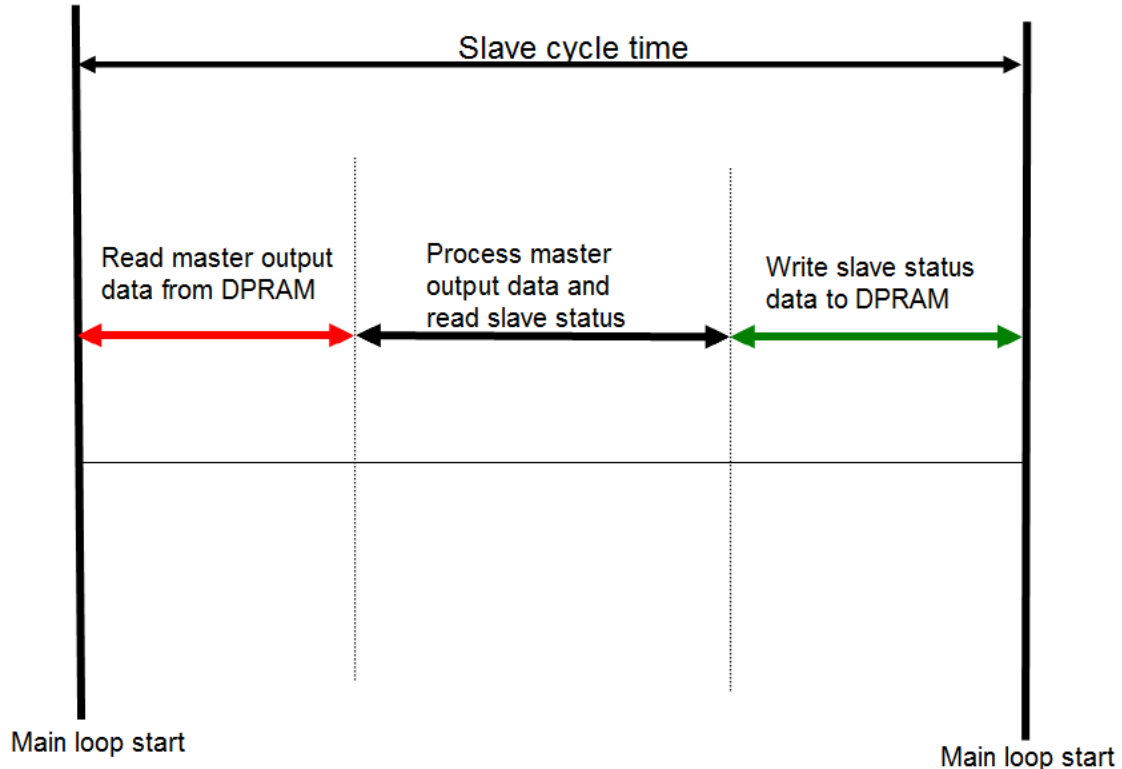

Figure 12: Slave processing sequence in Free-run mode

The slave firmware checks in each cycle time the memory of the EtherCAT slave chip (ESC) whether new output data has been received from the master. Newly received data will be processed. In the next step the encoder input status are being read from the FPGA chip. In the final step the read status are being written to the DPRAM, so that the master can retrieve the data ESC DPRAM in the next cycle time.

Free Run synchronization parameter has to be set in PREOP mode:

0x1C32.1 = 0

0x1C33.1 = 0

The setting of the Free Run synchronization parameter can be done in TwinCAT by clicking on the "CoE online" tab of the ECAT-2093 slave. Make sure the slave is set into PreOP mode before modifying the synchronization parameters

General EtherCAT DC Process Data Startup CoE - Online Online

Update List Auto Update Single Update Show Offline Data

Advanced...

Add to Startup... Module OD (AoE Port):

Index	Name	Flags	Value	Unit
1C32:0	SM output parameter		> 32 <	
1C32:01	Synchronization Type	RW	0x0001 (1)	
1C32:02	Cycle Time	RO	0x00000000 (0)	
1C32:04	Synchronization Types suppo...	RO	0x400F (16399)	
1C32:05	Minimum Cycle Time	RO	0x000186A0 (100000)	
1C32:06	Calc and Copy Time	RO	0x000061A8 (25000)	
1C32:08	Get Cycle Time	RW	0x0000 (0)	
1C32:09	Delay Time	RO	0x000009C4 (2500)	
1C32:0A	Sync0 Cycle Time	RW	0x0007A120 (500000)	
1C32:0B	SM-Event Missed	RO	0x0006 (6)	
1C32:0C	Cycle Time Too Small	RO	0x0000 (0)	
1C32:20	Sync Error	RO	TRUE	
1C33:0	SM input parameter		> 32 <	
1C33:01	Synchronization Type	RW	0x0002 (2)	
1C33:02	Cycle Time	RO	0x00000000 (0)	
1C33:04	Synchronization Types suppo...	RO	0x400F (16399)	
1C33:05	Minimum Cycle Time	RO	0x000186A0 (100000)	
1C33:06	Calc and Copy Time	RO	0x000061A8 (25000)	
1C33:08	Get Cycle Time	RW	0x0000 (0)	
1C33:09	Delay Time	RO	0x000009C4 (2500)	
1C33:0A	Sync0 Cycle Time	RW	0x0000A120 (41248)	
1C33:0B	SM-Event Missed	RO	0x0000 (0)	
1C33:0C	Cycle Time Too Small	RO	0x0000 (0)	
1C33:20	Sync Error	RO	FALSE	

Figure 13: SyncManager setting for Free-Run mode

5.3.2 SM-Synchron

In this mode both the master and the slave are synchronized but the data exchange cycle interval is not deterministic. The slave waits for the master to send a data telegram before starting to process the input and output data. In this mode the process data handling is being initiated by the master which determines the cycle time.

Once the output data sent by the master arrives at the slave it immediately starts processing the output data. In the next step the encoder input data will be written to the internal process data image of the slave. The input process data image will be read by the master in the next cycle.

SyncManager synchronization parameter:

0x1C32.1 = 0x1

0x1C33.1 = 0x22

By setting the operation mode of TwinCAT to "SM-Synchron" the SyncManager synchronization parameter are set by default to the above values.

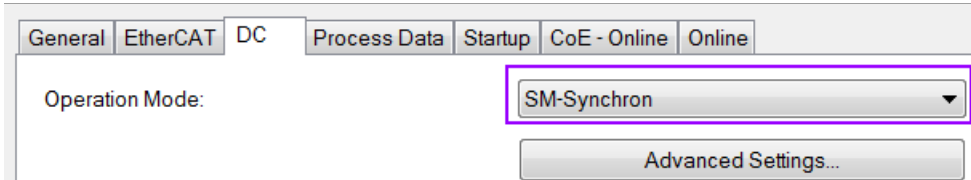

Figure 14: SM-Synchron mode selection

5.3.3 Distributed Clocks (DC Mode)

DC clock synchronization enables all EtherCAT devices (master and slaves) to share the same EtherCAT system time. The EtherCAT slaves in the network can be synchronized to each other. This enables the master to simultaneously set the output (e.g. digital output, pulse output) or to synchronously read inputs (e.g. digital input, encoder counter) of different slaves in the EtherCAT network.

For system synchronization all slaves are synchronized to one reference clock. Normally the first EtherCAT slave closest to the master with Distributed Clocks capability becomes the clock base for the master as well as for other DC slaves.

The EtherCAT slave is synchronized with the SYNC0 or SYNC1 event of the distributed clock system. After the EtherCAT network has been set into DC communication mode by the master, the ESC (EtherCAT slave chip) of each slave generates fixed time hardware interrupt which triggers the slave firmware to process the PDO data received from the master. The master cycle time and the ESC hardware interrupt time interval are fully synchronized to the first slave in the network that is used as a reference clock with the SYNC0 signal.

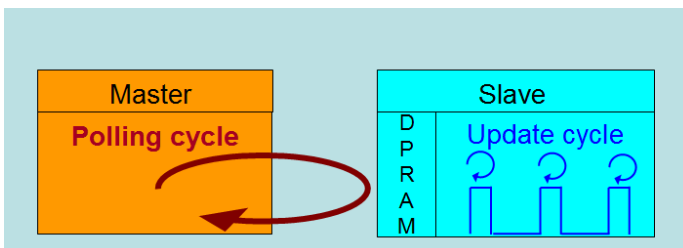

Figure 15: Master-slave cycle in DC mode

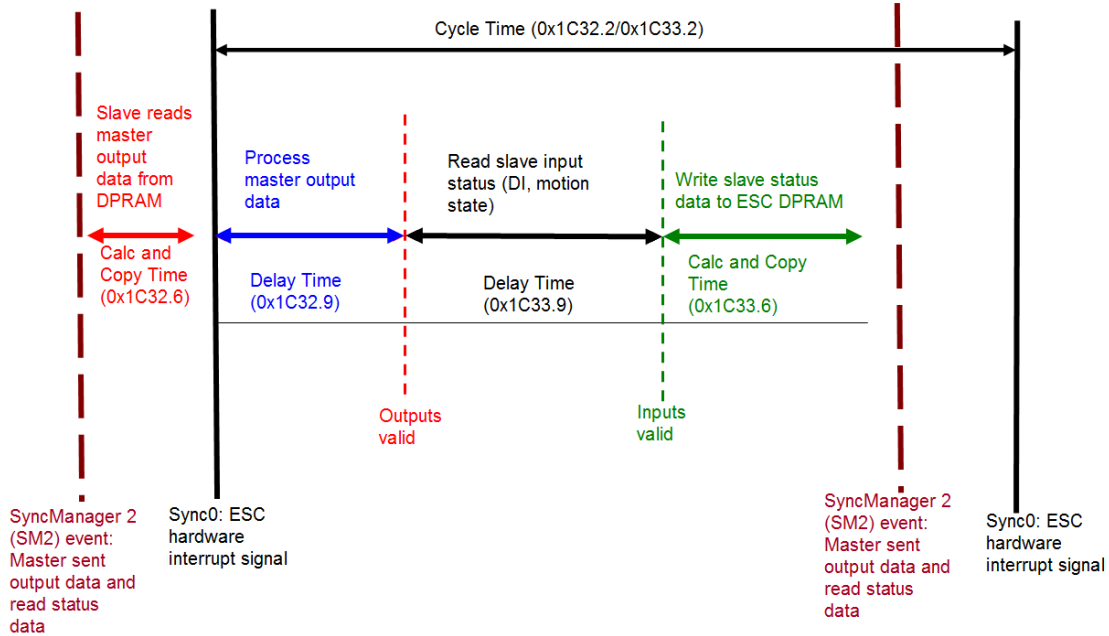

Figure 16: Internal slave processing sequence in DC mode

Once the slave receives process data (RxPDOs) from the master the SM2 event is triggered which causes the firmware to read the data from the ESC memory. The ESC interrupts the firmware at fixed time interval to process the data received from the master and write the status data to the ESC memory. Every time when the master fails to sent process data within the DC cycle time the internal sync error counter is being increase by three counts. This error counter is being decreased by one count for every successful DC cycle. Once the error counter reached the maximum count (default 4) a sync error will be generated and the slave goes into Safe OP mode (Sync Error 0x1C32:20 TRUE). The maximum count value can be set by changing the default value of the "Sync Error Counter Limit" (0x10F1:02).

Index	Name	Flags	Value
10F1:0	Error Settings		> 2 <
10F1:01	Local Error Reaction	RW	0x00000001 (1)
10F1:02	Sync Error Counter Limit	RW	0x0004 (4)

Figure 17: Sync error counter limit object

The setting of the sync manager for the output and input data is available at the TwinCAT "CoE online" tab.

Index	Name	Flags	Value
1C32:0	SM output parameter		> 32 <
1C32:01	Synchronization Type	RW	0x0002 (2)
1C32:02	Cycle Time	RO	0x00000000 (0)
1C32:04	Synchronization Types supported	RO	0x401F (16415)
1C32:05	Minimum Cycle Time	RO	0x001E8480 (2000000)
1C32:06	Calc and Copy Time	RO	0x0007A120 (500000)
1C32:08	Get Cycle Time	RW	0x0001 (1)
1C32:09	Delay Time	RO	0x000927C0 (600000)
1C32:0A	Sync0 Cycle Time	RW	0x005B8D80 (6000000)
1C32:0B	SM-Event Missed	RO	0x0000 (0)
1C32:0C	Cycle Time Too Small	RO	0x0000 (0)
1C32:20	Sync Error	RO	FALSE

Figure 18: SyncManager 2 parameters

SyncManager parameter description (time unit: nanosecond):

- Calc and Copy Time (0x1C32.6 / 0x1C33.6): Required time to copy the process data from the ESC to the local memory and calculate the output value.
- Delay Time (0x1C32.9 / 0x1C33.9): Delay from receiving the trigger to set the output or latch the input.
- Cycle Time (0x1C32.2 / 0x1C33.2): The current cycle time for the application. When using DC synchronization the value is read from register 0x9A0:0x9A3.
- 0x1C32.5 / 0x1C33.5 (Min Cycle Time): Minimum cycle time for the application. It is the total execution time of all slave application related operations.

6 Project Integration

In this chapter the integration of the ECAT-2093 device into a TwinCAT controlled EtherCAT network is being described. In general the ECAT-2093 is a standard EtherCAT slave which can be controlled by any standard EtherCAT master (e.g. Acontis, CODESYS, etc.).

6.1 ESI File

A ESI file describes the properties and functions supported by the ECAT-2093. By using the ESI file an easy and abstract integration of an EtherCAT device in a project tool is realized. With the help of the ESI file a detailed knowledge of EtherCAT is not required to configure the device. The TwinCAT EtherCAT master/System Manager needs the device description files in order to generate device configuration in online or offline mode.

6.1.1 Import of ESI File

Copy the XML description file "ECAT-2093.xml" of the ECAT-2093 device into the TwinCAT system directory and restart the TwinCAT system.

For TwinCat 3.1 copy the ESI file "ECAT-2093.xml" in the following directory:

C:\TwinCAT\3.1\Config\Io\EtherCAT

Software	Default directory path
Beckhoff EtherCAT Configuration	C:\EtherCAT Configurator\EtherCAT
Beckhoff TwinCAT 3.x	C:\TwinCAT\3.x\Config\Io\EtherCAT
Beckhof TwinCAT 2.x	C:\TwinCAT\Io\EtherCAT

Table 7: ESI file target directory

6.2 Device Setup and Configuration

In this manual only the online configuration of the slave module will be discussed. For offline configuration procedure please consult the TwinCAT user manual.

The following conditions must be met before a configuration can be set up:

- The ECAT-2093 slave devices must be connected via EtherCAT cables to the EtherCAT master. In this manual TwinCAT 3.1 version is being used as the EtherCAT master and

- configuration tool
- The ECAT-2093 devices has to be connected to a power supply and ready for communication
- Set the TwinCAT in CONFIG mode.

6.2.1 Scanning of the EtherCAT Device

After the TwinCAT has been set into CONFIG mode the online device search can be started.

- Step 1:** Right-click the “Devices” in the configuration tree to open the scan dialog. Click "Scan" to search the ECAT-2093 device.

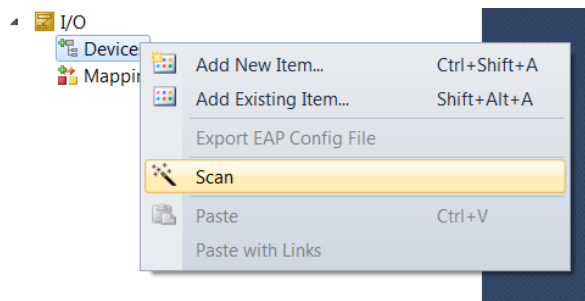

- Step 2:** Select "OK"

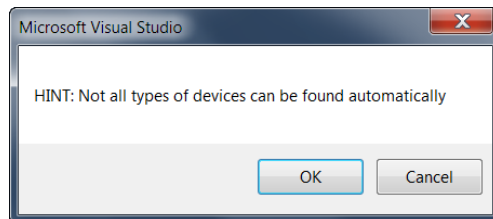

- Step 3:** Select the Ethernet device (Ethernet chip) to which the ECAT-2093 is connected to. Confirm the selection with "OK".

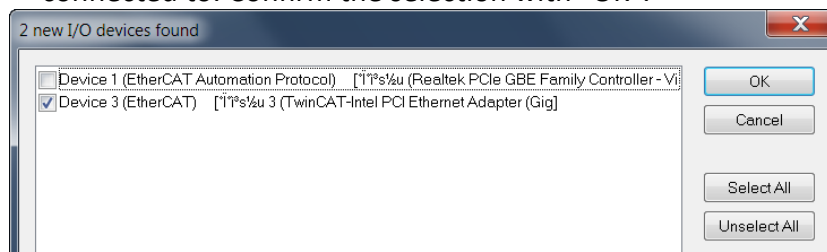
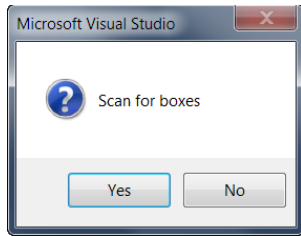
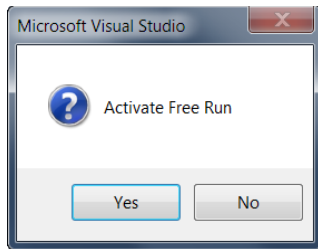

Figure 19: List of Ethernet chips detected on the EtherCAT master PC

- Step 4:** Start the scan process by clicking "Yes"



Step 5: Set the ECAT-2093 into Free-Run mode by clicking "Yes"



By default all three encoder channels are displayed in the tree view:

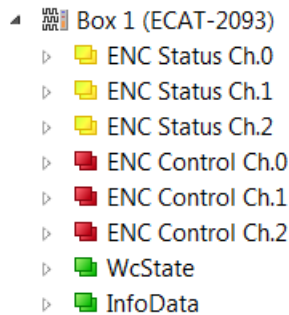

Figure 20: Default parameter selection for the ECAT-2093

6.2.2 Encoder Counter Configuration

The configuration of the ECAT-2093 device such as the encoder mode, filter setting etc. only needs to be done once before the actual encoder counting starts. These parameters have to be accessed via the CANopen over EtherCAT (CoE) protocol and are listed in the "CoE online" tab. The CoE protocol has a lower priority than the cyclic process data object (PDO) communication. Therefore the CoE parameters will not be updated in every cycle but only when the master has spare time.

Encoder relevant CoE parameter are listed in the Encoder setting object (Index 0x8000, 0x8010, 0x8020)

For each channel the following configuration procedure has to be done:

- Counter mode setting

- A/B/C signal polarity setting. The input signal may be active low or active high.
- Low pass filter clock cycle setting

Example of setting the encoder counting mode for each channel:

Step 1: Go to "ENC Setting Ch.0" of a channel. Extend the index tree and double click "Counting mode" with the index 8000:09 for channel 0.

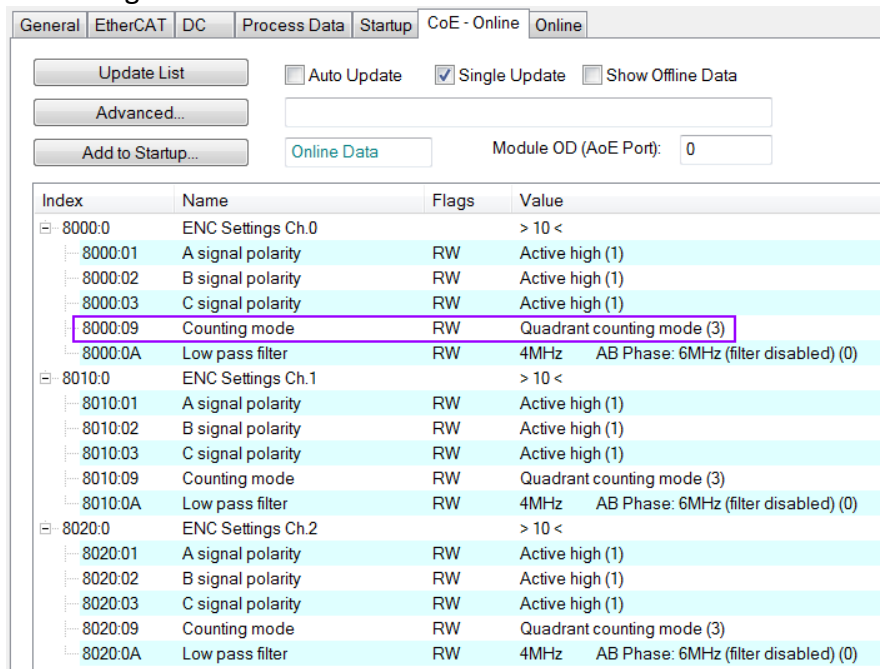

Step 2: Select one of the modes listed in the drop list and click "OK"

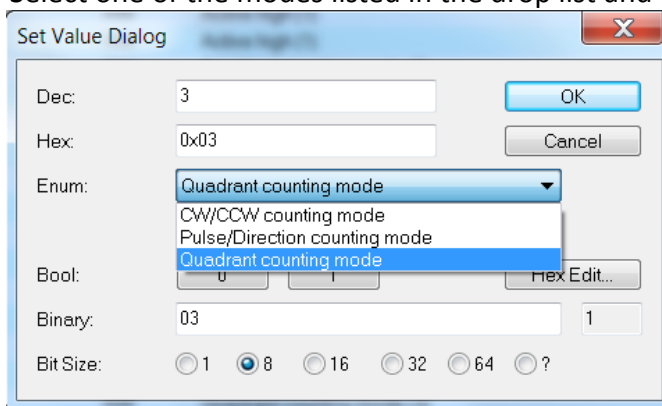

Step 3: Once the setting has been successfully sent to the slave it will be displayed in the CoE online parameter list. In the figure below "CW/CCW counting mode" has been selected for channel 0. This value needs only to be set once and therefore does not have to be sent in every cycle time.

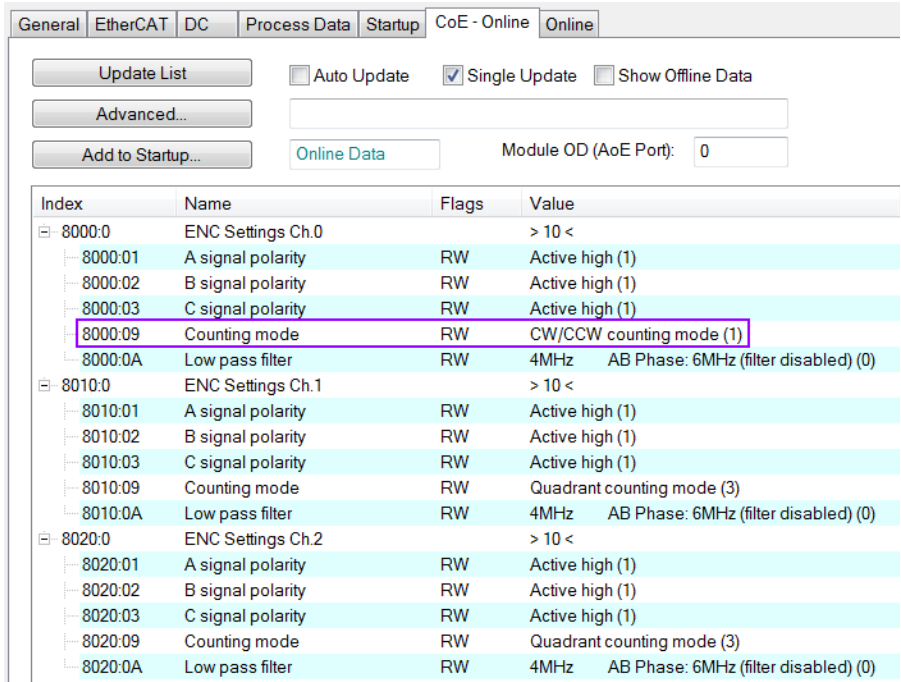

All the relevant encoder configurations have to be set first before the polling of the encoder counter starts. Once the parameters are set, the encoder counter is basically ready for operation.

If required, the configuration can be permanently save to an internal non-volatile memory of the ECAT-2093. After powering on the device it will immediately be initialized according configuration setting. For saving configuration data follow the instruction of chapter 8.2.

6.2.3 EtherCAT Slave Process Data Assignment

The user has to select the process data which has to be transferred between the EtherCAT master and slave during each cycle (Process Data Objects, PDOs). The process data exist of two parts:

- TxPDO: Data which is being read by the master (e.g. encoder status) .
- RxPDO: Data or parameters which is being sent to the slave (e.g. reset encoder position).

Once the parameters of the process data image has been defined by the user the master will exchange the in- and output data in every cycle.

The ECAT-2093 allows the user to select for each encoder channel the process data to be transmitted. In TwinCAT the supported process data objects are listed in the "PDO Assignment (0x1C12)" and "PDO Assignment (0x1C13)" boxes.

PDO selection procedure:

1. Activate the "Process Data" tab of the ECAT-2093 slave
2. For RxPDO selection: click in the "Sync Manager" window the "Outputs" line and in the "PDO Assignment (0x1C12)" window select for each encoder channel the required RxPDO (see Figure 21). For the ECAT-2093 only one RxPDO object for each encoder channel is available for selection. By default TwinCAT selects all the process data supported by the ECAT-2093. If the variables listed in the RxPDO are not required for the application then deselect the PDO in order to reduce the process data image size.
3. For TxPDO selection: click in the "Sync Manager" window the "Inputs" line and in the "PDO Assignment (0x1C13)" window select for each encoder channel the required TxPDO. The process data contains status variables for the encoder and latch values, and signal status information. It is necessary to select this process data object otherwise it is not possible to retrieve any status information from the encoder channel.

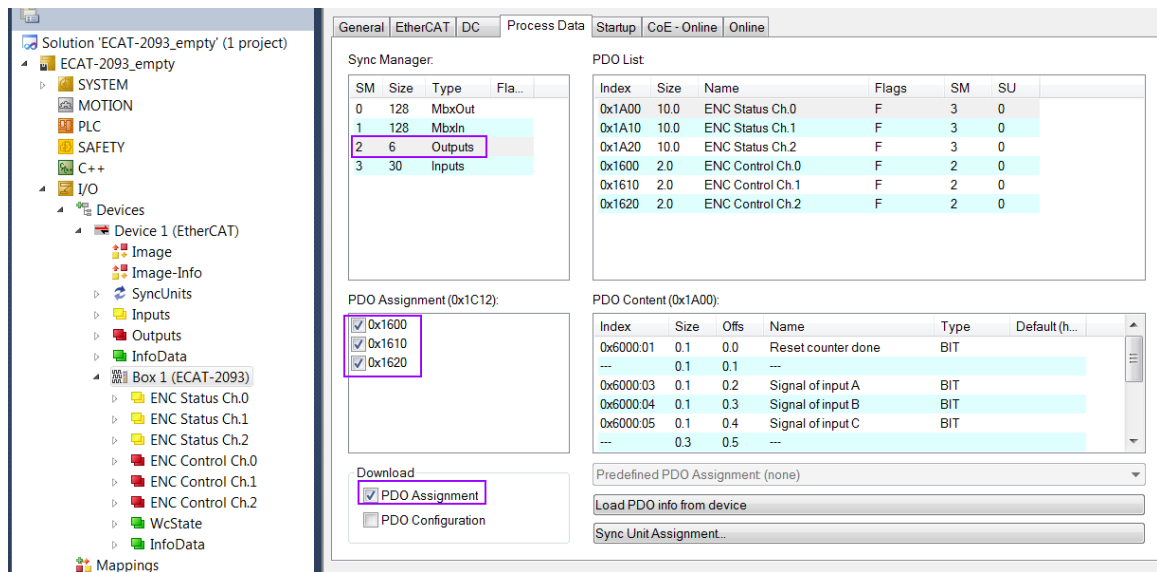

Figure 21: Predefined PDO assignment selection

Download the new PDO assignment to the Sync manager of the slave by clicking "Restart TwinCAT (Config Mode)" in the drop down menu. Make sure the check box next "PDO Assignment" is enabled.

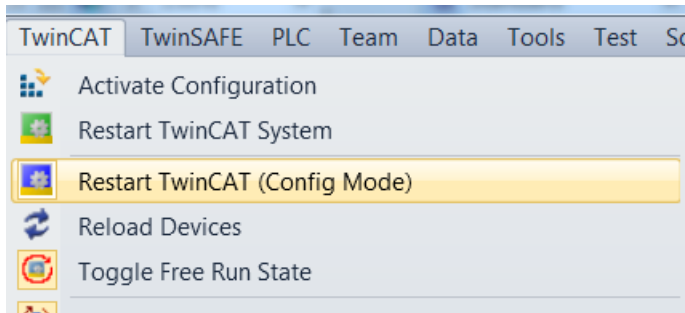

Figure 22: Download PDO assignment and restart TwinCAT

The device is now ready to be set into Free-Run or DC mode.

7 Parameter Description

7.1 Counting Mode

The ECAT-2093 encoder counter supports three modes:

- Pulse/Direction counting mode
- Clockwise/Counterclockwise mode
- Quadrant counting mode

The encoder counter mode has to be set via CoE (0x80n0:09, n= 0;1;2)

In the **pulse/direction counting mode** (Figure 23) one input signal line is being used to indicate the position and a second one indicates the direction of motion, either forward or reverse. The "A" signal serves as the counter input and the "B" signal serves as the direction input (B = high: enables up count; B = low: enables down count). The ECAT-2093 counts the rising or falling edges of the "A" signal pulses and the "B" signal determines the direction of the count and decides whether to increment or decrement the counter. On every active input signal "A" the position counter is incremented by one when the direction input "B" signal is high and decremented by one when the direction input "B" is low.

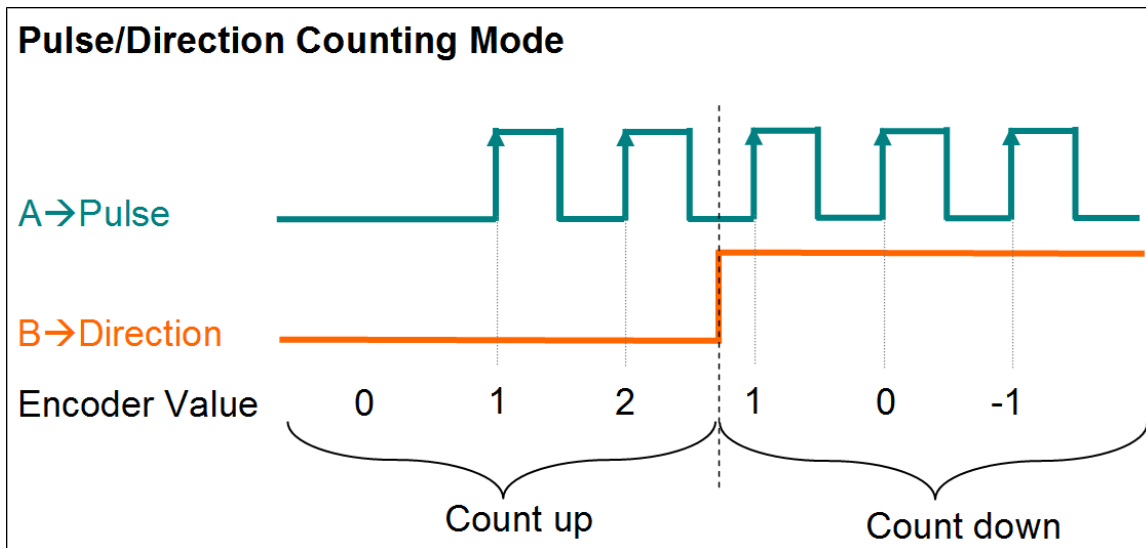

Figure 23: Pulse/Direction counting mode

In **clockwise/counterclockwise mode** (Figure 24) the "A" signal indicates a positive increments (clockwise signal) and the "B" signal a negative increments (counterclockwise signal). Therefore the encoder counter increases by one when the "A" signal is going high, while decreases by one when the "B" signal is going high.

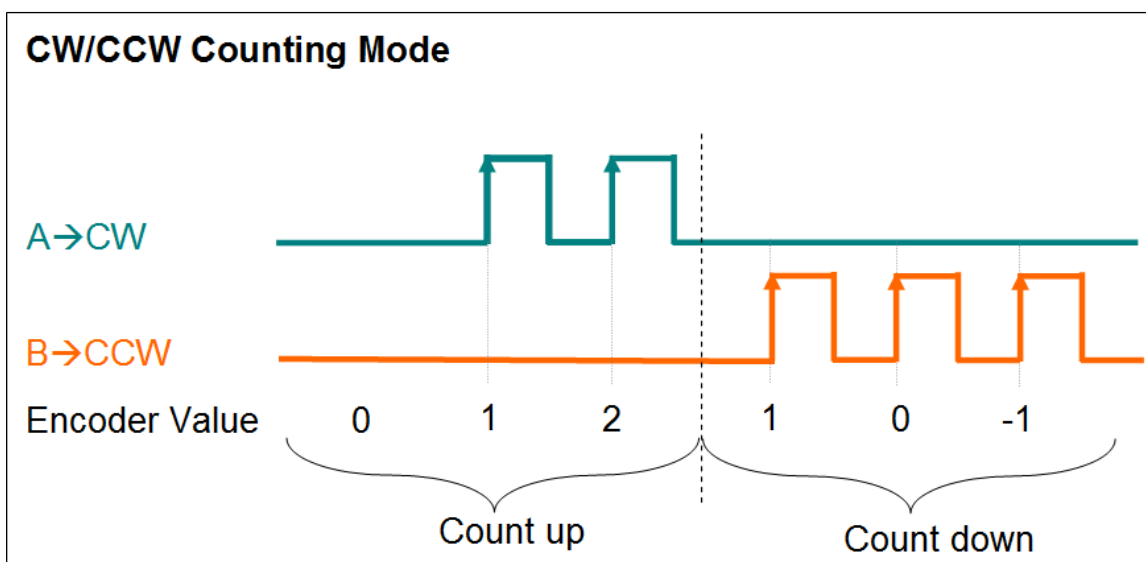

Figure 24: Clockwise/ Counterclockwise counting mode

In the **quadrant counting mode** (Figure 25) the encoder counter increments when signal "A" leads signal "B" and decrements when signal "B" leads signal "A". For example if the last input signal for both "A" and "B" was off and in the next cycle "A" is on and "B" is off then the direction is clockwise and the counter increments by one, but if "A" is off and "B" is on then the direction is counterclockwise and the counter decrements by one.

Both the rising and falling edges of "A" signal and "B" signal are counted.

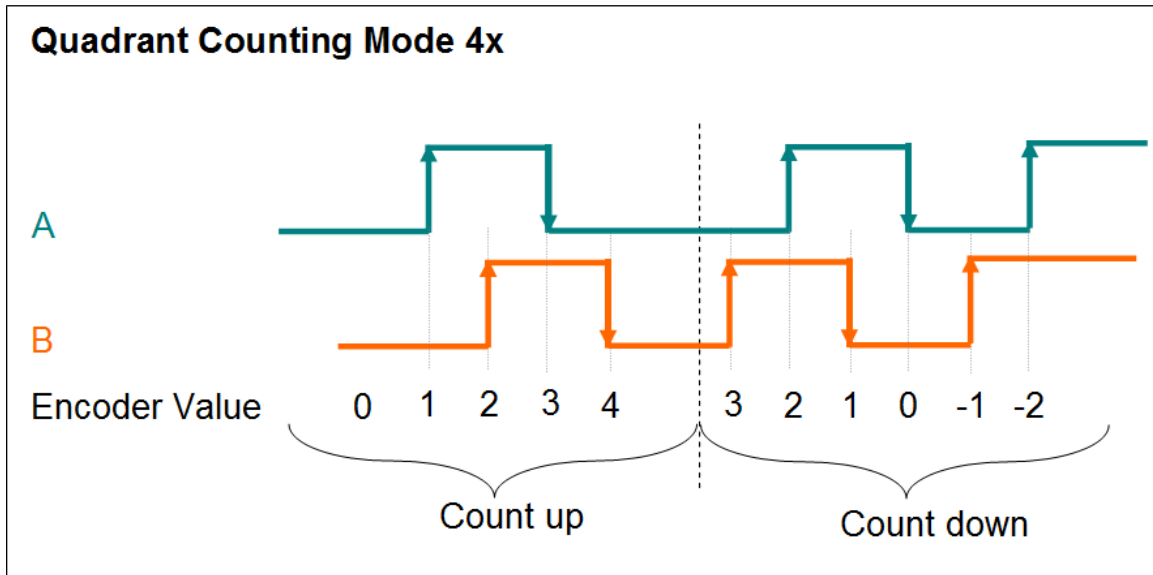

Figure 25: Quadrant counting mode

7.2 Signal Polarity Setting

The polarity of the encoder A,B,C signal indicates the active level of the signal. The active level of the encoder A, B and C signals has to be set via CoE:

- "A" signal 0x80n0:01
 - "B" signal 0x80n0:02
 - "C" signal 0x80n0:03
- n - represents the channel number (n= 0;1;2)

By changing the signal polarity of "A" and/or "B" the direction of counting may change. For example:

- By changing the signal "B" polarity which indicates the direction for the pulse/direction counting mode (Figure 23) the counting direction will change.
- By changing the polarity of signal "A" for the quadrant counting mode (Figure 26) results in a change of counting direction.
- Changing the signal polarity for the clockwise/counterclockwise mode will not change the counting direction

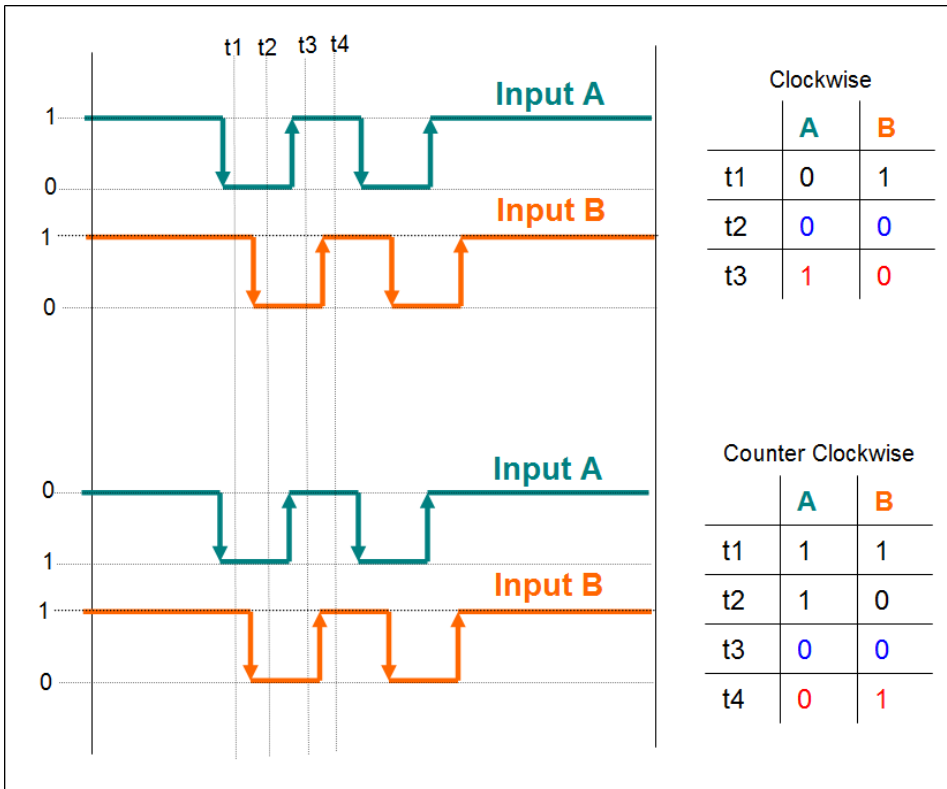

Figure 26: Polarity change of input signal "A" inverts the counting direction

7.3 Low Pass Filter Setting

Filters are for screening out noise from multiple inputs. The filter clock is used for sampling the input signal: if – and only if – three consecutive samples have the same value, the input is considered stable and the value is output from the filter. Table 8 list the filter clocks frequencies available for the ECAT-2093.

Low pass filter number	Maximum Input Frequency	
	Pulse/Direction counting mode Clockwise/Counterclockwise mode	Quadrant counting mode
0	4MHz (filter disabled)	6MHz (filter disabled)
1	4MHz	1MHz
2	2MHz	500KHz
3	1MHz	250KHz
4	640KHz	160KHz
5	320KHz	80KHz
6	160KHz	40Hz
7	80KHz	20KHz
8	40KHz	10KHz

Table 8: Filter clock frequencies

The filter clock has to be set via CoE (0x80n0:0A, n= 0;1;2)

When setting the filter make sure that the filter frequency is higher than the maximum encoder pulse output frequency otherwise the encoder counter may not count all the pulse of the incoming pulse train.

7.4 Encoder Status

This section will describe all the variables listed in the TxPDOs: 0x1A00, 0x1A20, 0x1A10. These variables basically show the status of the three input signals, the counter and latch value for each encoder counter channel (Table 9).

Parameter	Object	Description
Reset counter done	0x60n0:01	Indicates whether the "Encoder counter value" (0x60n0:11) has been reset to zero. The user has to set the "Reset encoder counter" (0x70n0:03) from FALSE to TRUE in order to reset the encoder value to zero.
Signal of input A	0x60n0:03	Shows whether the "A" signal is high or low
Signal of input B	0x60n0:04	Shows whether the "B" signal is high or low
Signal of input C	0x60n0:05	Shows whether the "C" signal is high or low
Sync error	0x60n0:0F	This variable informs the user whether a synchronization error occurred in Distributed Clock (DC) mode during the previous cycle. The master has to make sure that within each fixed time interval a datagram is being sent to the slave otherwise a synchronization error will be displayed
TxPDO Toggle	0x60n0:10	The slaves toggles this parameter each time TxPDO data has been updated
Actual counter value	0x60n0:11	Current encoder counter value
Latched counter value	0x60n0:12	Encoder value latched by the index signal "C". The encoder value will only be latched if the "Enable Latch C" (0x70n0:01) has been set to TRUE

Table 9: Encoder status variables

7.5 Encoder Outputs

The two parameters "Enable Latch C" and "Reset encoder counter" are part of the receive process data object (RxPDO): 0x1600, 0x1610, 0x1620.

Parameter	Object	Description
Enable Latch C	0x70n0:01	Set this value to TRUE to latch the encoder counter value when the index signal "C" is on. Every active signal will trigger a new counter latch event. The trigger level (rising edge or falling edge) has to be set via CoE (0x80n0:03,

		n=0;1;2)
Reset encoder counter	0x70n0:03	The encoder counter value will be set to zero once the "Reset encoder counter" value changes from FALSE to TRUE. The encoder counter value is automatically set to zero when the device is being switched on.

Table 10: Encoder output variables

The user may deselect these output process data objects if the output parameters are not required for the application.

8 CoE Interface

8.1 General Description

The CoE interface (CANopen over EtherCAT) is used for parameter management of EtherCAT devices. The CoE interface displays all the objects and parameters which are required for operating and diagnosing the ECAT-2093 device. Some parameters are fixed and can not be modified, they for example indicate the operating status of the device or the device properties. Encoder configuration parameters need to be set before the actual motion control starts. These parameter settings are determined by the encoder type and the setup of the system.

CoE parameters have to be accessed via the CAN over EtherCAT protocol. The EtherCAT master accesses the local CoE lists of the slaves via CAN over EtherCAT. The user does not need to understand the CoE protocol when using the TwinCAT System Manager for CoE parameter configuration.

The CoE parameters describe a wide range of features such as manufacturer ID, device name, process data settings and configuration parameters.

The relevant ranges of the CoE list are:

- 0x1000: Stores fixed information of the device, including name, manufacturer, serial number etc.. In addition stores information about the current and available process data configurations.
 - 0x1600: RxPDO mapping
 - 0x1A00: TxPDO mapping
- 0x8000: Stores all the configuration data which are required for the encoder counter.
- 0x6000: Input PDOs ("input" from the perspective of the EtherCAT master)
- 0x7000: Output PDOs ("output" from the perspective of the EtherCAT master)

The Figure 27 shows all of the CoE objects available for the ECAT-2093 device, ranging from 0x1000 to 0xF008. The parameters of the objects can be accessed by expanding the tree in the "CoE-Online" tab. The objects and their properties are described in chapter 9.

Index	Name	Flags	Value
1000	Device type	M RO	0x00020000 (131072)
1001	Error register	RO	0x00 (0)
1008	Device name	RO	ECAT-2093
1009	Hardware version	RO	1.3
100A	Software version	RO	1.0
1018:0	Identity		> 4 <
10F1:0	Error Settings		> 2 <
1600:0	ENC Control Ch.0		> 5 <
1610:0	ENC Control Ch.1		> 5 <
1620:0	ENC Control Ch.2		> 5 <
1A00:0	ENC Status Ch.0		> 11 <
1A10:0	ENC Status Ch.1		> 11 <
1A20:0	ENC Status Ch.2		> 11 <
1C00:0	Sync manager type		> 4 <
1C12:0	SyncManager 2 assignment		> 3 <
1C13:0	SyncManager 3 assignment		> 3 <
1C32:0	SM output parameter		> 32 <
1C33:0	SM input parameter		> 32 <
6000:0	ENC Inputs Ch.0		> 18 <
6010:0	ENC Inputs Ch.1		> 18 <
6020:0	ENC Inputs Ch.2		> 18 <
7000:0	ENC Outputs Ch.0		> 3 <
7010:0	ENC Outputs Ch.1		> 3 <
7020:0	ENC Outputs Ch.2		> 3 <
8000:0	ENC Settings Ch.0		> 10 <
8010:0	ENC Settings Ch.1		> 10 <
8020:0	ENC Settings Ch.2		> 10 <
F008:0	Internal EEPROM		> 6 <

Figure 27: "CoE - Online " tab

8.2 Save Configuration Data to Memory

In this section the procedure of saving encoder configuration parameters to the non-volatile memory of the ECAT-2093 is being discussed.

The CoE object range 0x8000 to 0x8020 contains all the parameters needed to configure the ECAT-2093. TwinCAT allows the user to set the configuration parameters via the System Manager (Figure 27) or from a TwinCAT PLC via ADS (TcEtherCAT.lib library).

If slave CoE parameters are set online, the ECAT-2093 device does not automatically store the data to its non-volatile memory, therefore the data will be lost once the device is switched off. The 0xF008 object provides functions to store the configuration data permanently to the non-volatile memory of the ECAT-2093 and the setting will be immediately available immediately after a restart.

Procedure for storing configuration data to the local ECAT-2093 memory:

Step 1: Make sure the TwinCAT System Manager is connected to the ECAT-2093 and the "CoE-Online" tab is showing that the slave is online.

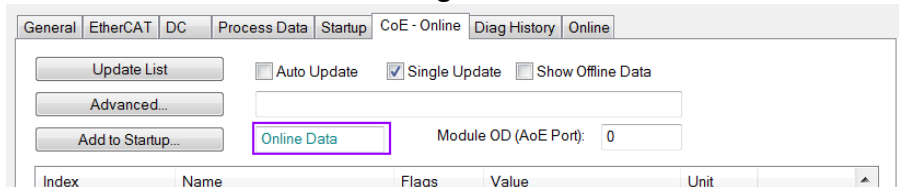

Step 2: Do all the necessary configuration by entering the correct parameter values for the configuration objects (0x8000, 0x8010, 0x8020). The setting is being done by double clicking the configuration parameter and selecting an option from the shown drop list box. In the following picture the signal polarity of the A signal of encoder channel 0 is being set.

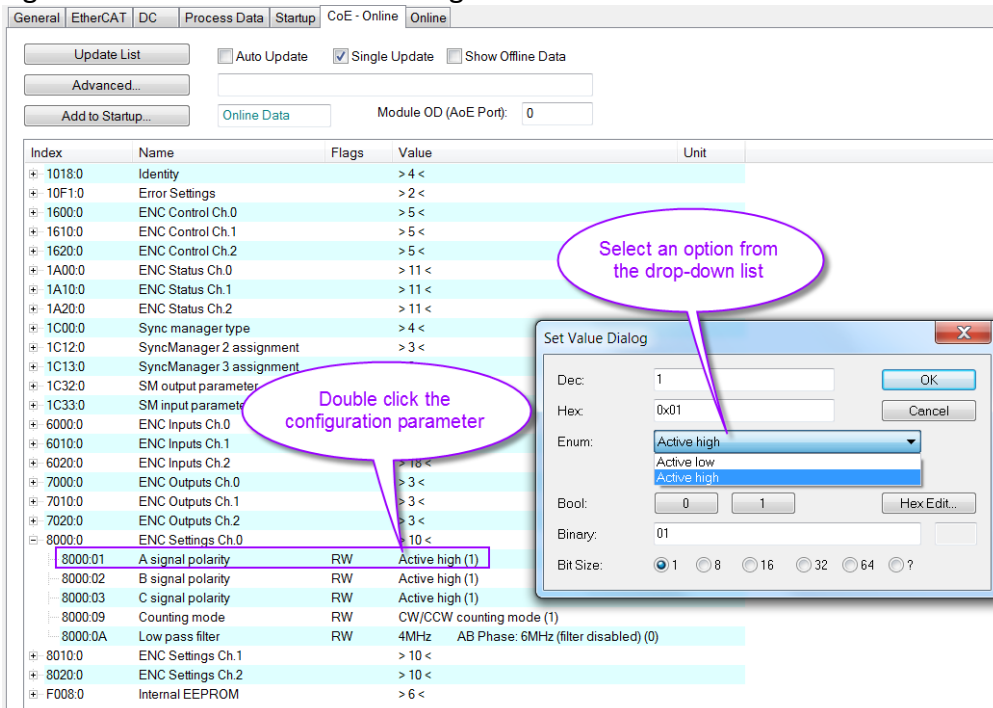

Step 3: After all the configurations have been done set the slave into Pre-Op mode. Data can only be stored to the local device if it is in Pre-Op mode. On the "Online" tab click the "Pre-OP" button to put the slave into Pre-OP mode.

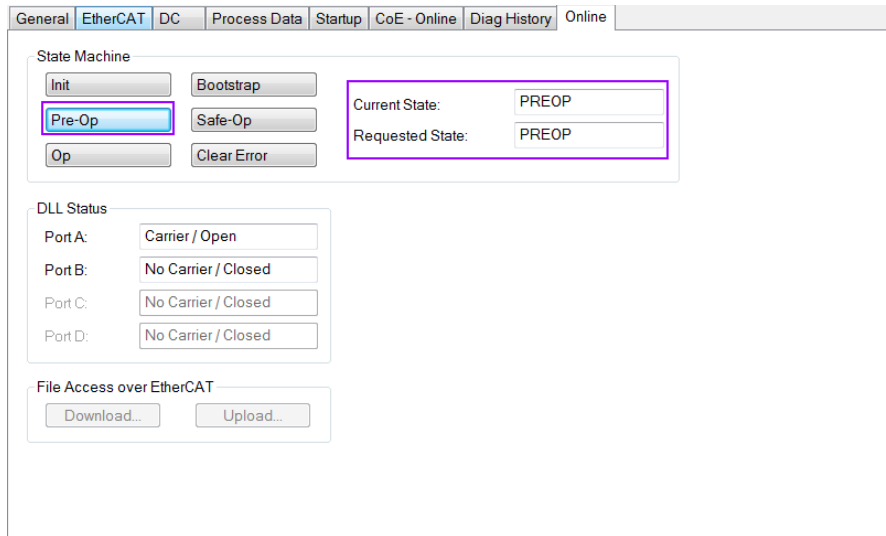

- Step 4:** The parameters of the 0xF008 object handles the save procedure.
1. Scroll to the end of the "CoE-Online" list and expand the tree view of the 0xF008 object
 2. Enter the value 0x12345678 for the "Code Word"
 3. Set the "Save configuration data" from FALSE to TRUE in order to save the configuration data to the internal EEPROM. The parameter "Save error encountered" (F008:05) indicates whether an error occurred during the save process.
 4. In order for the configuration data to be loaded after a device restart set the "Load factory default" to FALSE. It is always possible to return to the factory default setting by setting this value back to TRUE.
 5. The "Save Counter" (F008:02) shows how often configuration data has been stored to the local memory in the lifetime of the device.

ATTENTION:

The local memory only supports a limited number of save operations. Depending on the memory version once the save operation exceeds 10000 cycles it can no longer be guaranteed that data are reliably saved or are still readable. Therefore the "Save configuration data" (F008:04) and the "Load factory default" (F008:03) should not be continuously set from the controlling application program.

General | EtherCAT | DC | Process Data | Startup | CoE - Online | Online

Update List Auto Update Single Update Show Offline Data

Advanced...

Add to Startup... Online Data Module OD (AoE Port):

Index	Name	Flags	Value
+ 1C00:0	Sync manager type		> 4 <
+ 1C12:0	SyncManager 2 assignment		> 3 <
+ 1C13:0	SyncManager 3 assignment		> 3 <
+ 1C32:0	SM output parameter		> 32 <
+ 1C33:0	SM input parameter		> 32 <
+ 6000:0	ENC Inputs Ch.0		> 18 <
+ 6010:0	ENC Inputs Ch.1		> 18 <
+ 6020:0	ENC Inputs Ch.2		> 18 <
+ 7000:0	ENC Outputs Ch.0		> 3 <
+ 7010:0	ENC Outputs Ch.1		> 3 <
+ 7020:0	ENC Outputs Ch.2		> 3 <
+ 8000:0	ENC Settings Ch.0		> 10 <
+ 8010:0	ENC Settings Ch.1		> 10 <
+ 8020:0	ENC Settings Ch.2		> 10 <
- F008:0	Internal EEPROM		> 6 <
F008:01	Code word	RW	0x12345678 (305419896)
F008:02	Save counter	RO	0xFFFF (65534)
F008:03	Load factory default	RW	FALSE
F008:04	Save configuration data	RW	TRUE
F008:05	Save error encountered	RO	FALSE
F008:06	Initialization error	RO	FALSE

Step 5: Set the ECAT-2093 back into OP mode.

General | EtherCAT | DC | Process Data | Startup | CoE - Online | Diag History | Online

State Machine

Init Bootstrap

Pre-Op Safe-Op

Op Clear Error

Current State:

Requested State:

DLL Status

Port A:

Port B:

Port C:

Port D:

File Access over EtherCAT

Download... Upload...

9 Object Description and Parameterization

9.1 Standard Objects

Index 1000 Device type

Index (hex)	Name	Description	Data type	Flags	Default
1000:0	Device type	Device type of the EtherCAT slave	UINT32	RO	0x00020000

Index 1008 Device name

Index (hex)	Name	Description	Data type	Flags	Default
1008:0	Device name	Device name of the EtherCAT slave	STRING	RO	ECAT-2093

Index 1009 Hardware version

Index (hex)	Name	Description	Data type	Flags	Default
1009:0	Hardware version	Hardware version of the EtherCAT slave	STRING	RO	1.3 (or greater)

Index 100A Software version

Index (hex)	Name	Description	Data type	Flags	Default
100A:0	Software version	Software version of the EtherCAT slave	STRING	RO	1.0 (or greater)

Index 1018 Identity

Index (hex)	Name	Description	Data type	Flags	Default
1018:0	Identity		UINT8	RO	0x04
1018:01	Vendor ID	Vendor ID of the EtherCAT slave	UINT32	RO	0x00494350
1018:02	Product code	Product code of the EtherCAT slave	UINT32	RO	0x0000082D (2093)
1018:03	Revision	Revision number of the EtherCAT slave	UINT32	RO	0x00010000
1018:04	Serial number	Serial number of the EtherCAT slave (not supported)	UINT32	RO	0x00000000

Index 10F1 Error settings

Index (hex)	Name	Description	Data type	Flags	Default
10F1:0	Error settings		UINT8	RO	0x02
10F1:01	Local error reaction	Not implemented	UINT32	RW	0x00000001
10F1:02	Sync error counter limit	For DC mode only: The Sync Error Counter is incremented with every missing Sync Management Event by three and decremented by one if an event is	UINT16	RW	0x0004

		received. If the Sync Error Counter exceeds this limit the system changes into the SAFEOP state with the 'Synchronization Lost' error. The Sync Error Counter is reset when the error was acknowledged.			
--	--	---	--	--	--

9.2 RxPDO Mapping Objects

Index 0x16n0 ENC Control Ch.n (RxPDO-Map)

Index (hex)	Name	Description	Data type	Flags	Default
16n0:0	ENC Control _Ch0_	Encoder control	UINT8	RO	0x05
16n0:01	Control__Enable latch C	Enable the encoder latch (1 Bit)	UINT32	RO	0x70n00101
16n0:02	Control__Gap1	empty (1 Bit)	UINT32	RO	0x00000001
16n0:03	Control__Reset encoder counter	Set encoder (1 Bit)	UINT32	RO	0x70n00301
16n0:04	Control__Gap2	BYTE padding (5 Bit)	UINT32	RO	0x00000005
16n0:05	Control__Gap3	WORD padding (8 Bit)	UINT32	RO	0x00000008

"n" represents the channel number (0 to 2)

9.3 TxPDO Mapping Objects

Index 0x1An0 ENC StatusCh.n (TxPDO-Map)

Index (hex)	Name	Description	Data type	Flags	Default
1An0:0	ENC Status	Encoder status	UINT8	RO	0x0B
1An0:01	Status__Reset counter done	Counter reset to zero (1 Bit)	UINT32	RO	0x60n00101
1An0:02	Status__Gap1	empty (1 Bit)	UINT32	RO	0x00000001
1An0:03	Status__Signal of input A	Channel A input signal (1 Bit)	UINT32	RO	0x60n00301
1An0:04	Status__Signal of input B	Channel B input signal (1 Bit)	UINT32	RO	0x60n00401
1An0:05	Status__Signal of input C	Channel C input signal (1 Bit)	UINT32	RO	0x60n00501
1An0:06	Status__Gap2	BYTE padding	UINT32	RO	0x00000003

		(3 Bit)			
1An0:07	Status__Gap3	empty (6 Bit)	UINT32	RO	0x00000006
1An0:08	Status__Sync error	Sync error (1 Bit)	UINT32	RO	0x60n00F01
1An0:09	Status__TxPDO Toggle	TxPDO Toggle (1 Bit)	UINT32	RO	0x60n01001
1An0:0A	Status__Encoder counter value	Encoder counter value (32-Bit)	UINT32	RO	0x60n01120
1An0:0B	Status__Latched counter value	Latched encoder counter (32-Bit)	UINT32	RO	0x60n01220

"n" represents the channel number (0 to 2)

9.4 Sync Manager Objects

Index 0x1C00 Sync manager type

Index (hex)	Name	Description	Data type	Flags	Default
1C00:0	Sync manager type	Using the sync managers	UINT8	RO	0x04
1C00:01	SubIndex 001	Sync-Manager Type Channel 1: Mailbox Write	UINT8	RO	0x01
1C00:02	SubIndex 002	Sync-Manager Type Channel 2: Mailbox Read	UINT8	RO	0x02
1C00:03	SubIndex 003	Sync-Manager Type Channel 3: Process Data Write (Outputs)	UINT8	RO	0x03
1C00:04	SubIndex 004	Sync-Manager Type Channel 4: Process Data Read (Inputs)	UINT8	RO	0x04

Index 0x1C12 RxPDO assign

Index (hex)	Name	Description	Data type	Flags	Default
1C12:0	RxPDO assign	SyncManager 2 assignment: PDO Assign Outputs	UINT8	RO	0x1C
1C12:01	SubIndex 001	Default assignment: ENC Control Channel 0	UINT16	RW	0x1600
1C12:02	SubIndex 002	Default assignment: ENC Control Channel 1	UINT16	RW	0x1610
1C12:03	SubIndex 003	Default assignment: ENC Control Channel 2	UINT16	RW	0x1620

Index 0x1C13 TxPDO assign

Index	Name	Description	Data type	Flags	Default
-------	------	-------------	-----------	-------	---------

(hex)					
1C13:0	TxPDO assign	SyncManager 3 assignment: PDO Assign Inputs	UINT8	RO	0x20
1C13:01	SubIndex 001	Default assignment: ENC Status Channel 0	UINT16	RW	0x1A00
1C13:02	SubIndex 002	Default assignment: ENC Status Channel 1	UINT16	RW	0x1A10
1C13:03	SubIndex 003	Default assignment: ENC Status Channel 2	UINT16	RW	0x1A20

Index 0x1C32 Sync Manager (SM) output parameter

Index (hex)	Name	Description	Data type	Flags	Default
1C32:0	SM output parameter	Synchronization parameters for the outputs	UINT8	RO	0x20
1C32:01	Synchronization Type	Current synchronization mode: <ul style="list-style-type: none"> 0: Free Run 1: Synchronous without SM 2 event 2: DC-Mode - Synchronous with SYNC0 Event 3: DC-Mode - Synchronous with SYNC1 event 	UINT8	RO	0x0001
1C32:02	Cycle Time	Cycle time (in ns): <ul style="list-style-type: none"> Free Run: Cycle time of the local timer Synchronous with SM 2 event: Master cycle time DC mode: SYNC0/SYNC1 Cycle Time 	UINT8	RO	0x00000000
1C32:04	Synchronization Types supported	Supported synchronization modes: <ul style="list-style-type: none"> Bit 0 = 1: free run is supported Bit 1 = 1: Synchron with SM 2 event is supported Bit 2-3 = 01: DC mode is supported Bit 4-5 = 10: Output shift with SYNC1 event (only DC mode) 	UINT8	RO	0x8007
1C32:05	Minimum Cycle Time	Minimum cycle time (in ns)		RO	0x00000000
1C32:06	Calc and Copy Time	Minimum time between SYNC0 and SYNC1 event (in ns, DC mode only)		RO	0x00000000
1C32:08	Get Cycle Time	<ul style="list-style-type: none"> 0: Measurement of the local cycle time is stopped 1: Measurement of the local cycle time is started 		RW	0x0000

		Set parameter to 1 in order to update the Cycle Time (1C32:02, 1C33:02) parameter with the maximum measured value			
1C32:09	Delay Time	Time between SYNC1 event and output (in ns, DC mode only)		RO	0x00000000
1C32:0A	Sync0 Cycle Time			RW	0x00000000
1C32:0B	SM-Event Missed	Number of missed SM events in OPERATIONAL (DC mode only)		RO	0x0000
1C32:0C	Cycle Time Too Small	Cycle was not completed in time or the next cycle began too early		RO	0x0000
1C32:20	Sync Error	The synchronization was not correct in the last cycle (outputs were output too late; DC mode only)		RO	FALSE

Index 0x1C33 Sync Manager (SM) input parameter

Index (hex)	Name	Description	Data type	Flags	Default
1C33:0	SM input parameter	Synchronization parameters for the inputs	UINT8	RO	0x20
1C33:01	Synchronization Type	Current synchronization mode: <ul style="list-style-type: none"> 0: Free Run 1: Synchron with SM 3 Event (no outputs available) 2: DC - Synchron with SYNC0 Event 3: DC - Synchron with SYNC1 Event 34: Synchron with SM 2 Event (outputs available) 	UINT8	RO	0x0022
1C33:02	Cycle Time	Cycle time (in ns): <ul style="list-style-type: none"> Free Run: Cycle time of the local timer Synchronous with SM 2 event: Master cycle time DC mode: SYNC0/SYNC1 Cycle Time 	UINT8	RO	0x00000000
1C33:04	Synchronization Types supported	Supported synchronization modes: <ul style="list-style-type: none"> Bit 0 = 1: free run is supported Bit 1 = 1: Synchron with SM 2 event is supported Bit 2-3 = 01: DC mode is supported 	UINT8	RO	0x8007

		<ul style="list-style-type: none"> Bit 4-5 = 10: Output shift with SYNC1 event (only DC mode) 			
1C33:05	Minimum Cycle Time	Minimum cycle time (in ns)		RO	0x00000000
1C33:06	Calc and Copy Time	Time between reading of the inputs and availability of the Inputs data for the master (in ns, only DC mode)		RO	0x00000000
1C33:08	Get Cycle Time	<ul style="list-style-type: none"> 0: Measurement of the local cycle time is stopped 1: Measurement of the local cycle time is started Set parameter to 1 in order to update the Cycle Time (1C32:02, 1C33:02) parameter with the maximum measured value		RW	0x0000
1C33:09	Delay Time	Time between SYNC1 event and reading of the inputs (in ns, only DC mode)		RO	0x00000000
1C33:0A	Sync0 Cycle Time			RW	0x00000000
1C33:0B	SM-Event Missed	Number of missed SM events in OPERATIONAL (DC mode only)		RO	0x0000
1C33:0C	Cycle Time Too Small	Cycle was not completed in time or the next cycle began too early		RO	0x0000
1C33:20	Sync Error	The synchronization was not correct in the last cycle (outputs were output too late; DC mode only)		RO	FALSE

9.5 Input Data

Index 0x60n0 ENC Inputs Ch.n

Index (hex)	Name	Description	Data type	Flags	Default
60n0:0	Get encoder input status	Encoder status inputs	UINT8	RO	0x12
60n0:01	Reset counter done	Reset counter to zero completed. Indicates whether the "Reset encoder counter" (70n0:03) action was successful	BOOLEAN	RO	
60n0:03	Signal of input A	Signal of input A	BOOLEAN	RO	
60n0:04	Signal of input B	Signal of input B	BOOLEAN	RO	

60n0:05	Signal of input C	Signal of input C	BOOLEAN	RO	
60n0:0F	Sync error	The Sync error bit is only required for DC mode. It indicates whether a synchronization error has occurred during the previous cycle	BOOLEAN	RO	
60n0:10	TxPDO Toggle	The TxPDO toggle is toggled by the slave when the data of the associated TxPDO is updated	BOOLEAN	RO	
60n0:11	Actual counter value	The encoder counter value	INT32	RO	
60n0:12	Latched counter value	The latched counter value. Hardware index latch function needs to be activated via "Enable Latch C" (70n0:01). The trigger condition (falling or rising edge) has to be set via "C signal polarity" (80n0:03). A latch event is generated every time when the trigger condition is being met.	INT32	RO	

"n" represents the channel number (0 to 2)

9.6 Output Data

Index 0x70n0 ENC Outputs Ch.n

Index (hex)	Name	Description	Data type	Flags	Default
70n0:0	ENC Outputs		UINT8	RO	0x03
70n0:01	Enable Latch C	Enable the encoder to latch the encoder value at each C channel input signal <ul style="list-style-type: none"> By setting this Boolean from FALSE to TRUE the hardware index latch function is enabled. The encoder value (60n0:11) will be latch when the C input level is being 	BOOLEAN	RO	FALSE

		triggered <ul style="list-style-type: none"> By setting this variable to FALSE the index latch function will be disabled and the latched counter value register (60n0:12) reset to zero 			
70n0:03	Reset encoder counter	Reset the encoder counter to zero <ul style="list-style-type: none"> By setting this bit from FALSE to TRUE the Encoder counter value (60n0:11) will be set to zero 	BOOLEAN	RO	FALSE

"n" represents the channel number (0 to 2)

9.7 Configuration Data

Index 0x80n0 ENC Settings Ch.n

Index (hex)	Name	Description	Data type	Flags	Default
80n0:0	ENC Settings	Encoder settings	UINT8	RO	0x0E
80n0:01	A signal polarity	Polarity of A input signal	DT0803EN01	RW	0x00 ("Active low")
80n0:02	B signal polarity	Polarity of B input signal	DT0803EN01	RW	0x00 ("Active low")
80n0:03	C signal polarity	Polarity of C input signal	DT0803EN01	RW	0x00 ("Active low")
80n0:09	Counting mode	Counter mode selection: <ul style="list-style-type: none"> CW/CCW, Pulse/Direction, Quadrant 	DT0801EN08	RW	0x03 ("Quadrant counting mode")
80n0:0A	Low pass filter	Low pass filter setting	DT0802EN08	RW	0x00 ("4MHz AB Phase: 6MHz (filter disabled)")

"n" represents the channel number (0 to 2)

9.8 Configuration Parameters Storage

Index 0xF008 Internal EEPROM

Index (hex)	Name	Description	Data type	Flags	Default
F008:0	Internal EEPROM	Storing CoE parameters to the internal EEPROM.	UINT8	RO	0x05
F008:01	Code Word	Password for saving CoE configuration data to the EEPROM Password: 0x12345678	UINT32	RW	0x00000000
F008:02	Save Counter	Total number of save sequence	UINT16	RO	0x0000
F008:03	Load factory default	Load factory default configuration immediately after power on. <ul style="list-style-type: none"> By setting this parameter to FALSE the user set configuration data (0x8000 to 0x8020) will be loaded after power on 	BOOLEAN	RW	TRUE
F008:04	Save configuration data	Save all configuration setting to local non-volatile memory. <ul style="list-style-type: none"> Set to TRUE in order to save the configuration data (0x8000 to 0x8020) to the memory of the ECAT-2093 	BOOLEAN	RW	FALSE
F008:05	Save error encountered	Indicates whether data has been successfully written to memory	BOOLEAN	RO	FALSE

