

---

# IR-712-MTCP

## Universal IR Learning Remote Module

User Manual  
v1.2



[www.icpdas.com](http://www.icpdas.com)



---

## **Warranty**

All products manufactured by ICP DAS are under warranty regarding defective materials for a period of one year from the date of delivery to the original purchaser.

## **Warning**

ICP DAS assumes no liability for damages resulting from the use of this product. ICP DAS reserves the right to change this manual at any time without notice. The information furnished by ICP DAS is believed to be accurate and reliable. However, no responsibility is assumed by ICP DAS for its use, or for any infringements of patents or other rights of third parties resulting from its use.

## **Copyright**

Copyright 2015 by ICP DAS. All rights are reserved.

## **Trademark**

The names used for identification only may be registered trademarks of their respective companies.

---

# Contents

<b>1. Introduction</b>	<b>3</b>
1.1 Features	4
<b>2. Hardware</b>	<b>5</b>
2.1 Specifications	5
2.2 Appearance	6
2.3 Pin assignments	7
2.4 Wire connection	8
2.4.1 IR Output Jack	8
2.4.2 Power connection	8
2.5 Watchdog setting	9
2.6 DIP Switch for Firmware Update/Default Communication	10
2.6.1 Update firmware / Default Communication	10
2.6.2 Firmware operation mode	11
2.7 LED Indicators	12
<b>3. Software</b>	<b>13</b>
3.1 Configuration tool- IR Utility	13
3.2 IR-712-MTCP Utility	14
3.2.1 Main Window of the IR-712-MTCP Utility	15
3.2.2 Menu	16
3.2.3 Communication Interface (Connect/Disconnect)	20
3.2.4 Set Device & IR Command Quantity	20
3.2.5 Test and Save IR Learned Commands	22
3.2.6 Test the IR commands in IR-712-MTCP	24
<b>4. Example of Learning IR commands</b>	<b>25</b>
4.1 Connect to the IR-712-MTCP	25
4.2 Configure the quantity of the IR commands	26
4.3 Learning and Testing IR commands	27
4.4 Saving the Learned IR Commands to a File	28
4.5 Download the IR Learning Commands	28
4.6 Test the IR commands saved in the IR-712-MTCP	28
4.7 Load the IR Learning Commands from the File	29
4.8 Load IR Learning Commands from the Module	29
4.9 Copy IR commands from other IR learning data files	29
<b>5. Modbus Registers Addresses</b>	<b>32</b>
<b>6. Technical support</b>	<b>34</b>
<b>Appendix A Update Firmware</b>	<b>35</b>

# 1. Introduction

IR-712-MTCP is a universal IR learning remote module which can learn IR remote commands of diverse electronic appliances. The IR learning commands can be stored in the module or saved to a file. IR-712-MTCP supplies 2 IR output channels for individual or simultaneous control on multiple appliances. The Ethernet interface with Modbus/TCP and Modbus/UDP protocol provides more flexible expansion and control on the module. Besides, the software utility provides users with easy configuration, IR learning, test and storage of IR commands on the IR-712-MTCP. As a replacement of IR remote controls and a module that can be easily integrated with Modbus client devices (e.g. PAC, PLC, PC... etc.), IR-712-MTCP is well-suited for smart home and building automation.

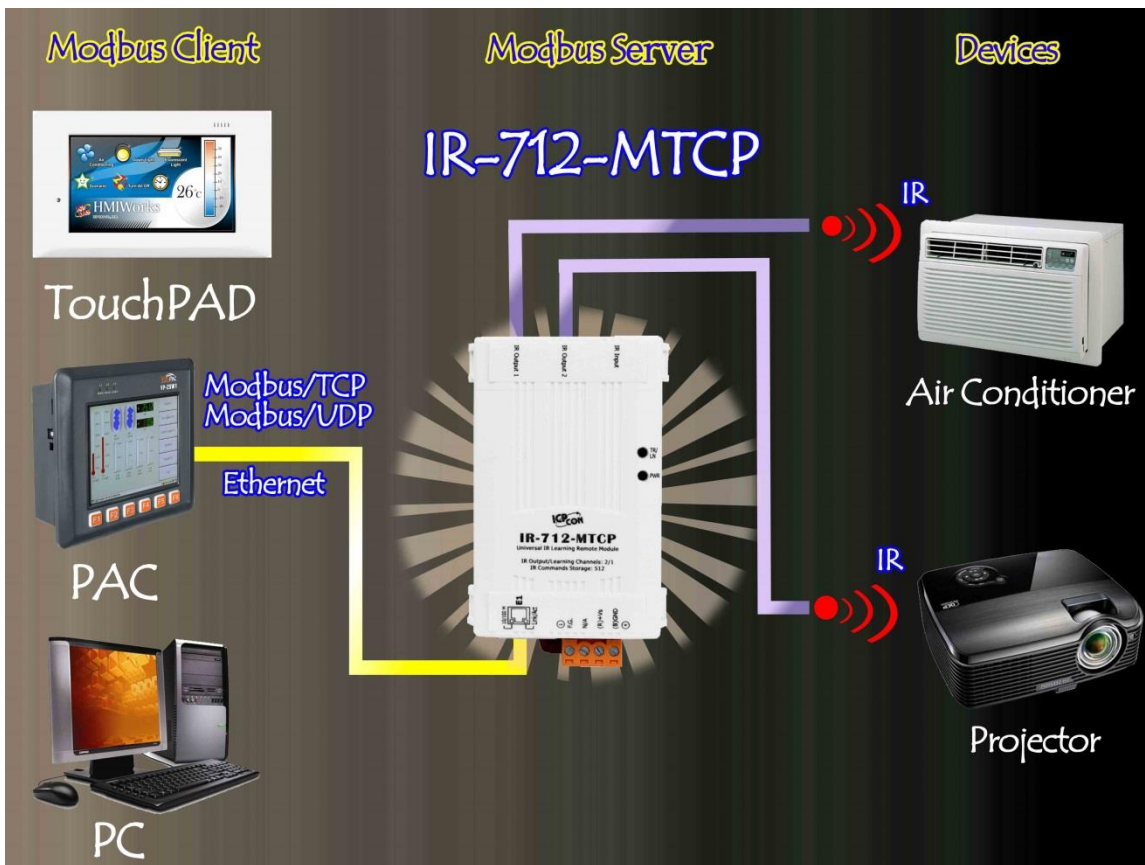

Figure 1-1 The basic application architecture of the IR-712-MTCP.

---

## 1.1 Features

### [IR-712-MTCP]

- 2 IR output channels for controlling multiple devices.
- 1 IR learning input.
- Supports 6 IR carrier frequencies: 32.768 、 36 、 37.037 、 38 、 40 and 56 kHz.
- Can store 512 IR commands.
- Supports Ethernet interface.
- Supports Modbus/TCP and Modbus/UDP protocol (FC6 and FC16).
- Supports connections of 5 Modbus/TCP clients
- Assignable Modbus Network IDs: 1 ~ 247
- Provides transmitting / learning and power indication LEDs.
- Built-in Watchdog.
- RoHS Compliance.

### [Utility]

- Configuration of IR command quantity.
- IR commands learning and testing.
- Save IR learning commands to files.
- Get / Set IR learning commands from / to IR-712-MTCP.
- Reference to Modbus commands.
- Set / Reset basic settings of IR-712-MTCP.
- Supports Windows Vista, Windows 7 and Windows 8 with .NET framework 4.5 platform.

### [Applications]

- Home Entertainment Devices
- Video Conferencing System
- Surveillance System
- e-Classroom service
- Lighting Scenario Control
- Home and Building Automation

---

## 2. Hardware

### 2.1 Specifications

IR Interface		
IR Output Channels	2 channels with 3.5 mm audio jack	
IR Learning Input	1 channel. Supports 6 IR carrier frequencies: 32.768, 36, 37.037, 38, 40, 56 kHz.	
Serial Communication Interface		
Ethernet	10/100 Base-TX, 8-Pin RJ-45 x1 (Auto-negotiating, Auto-MDI/MDIX, LED indicator)	
Protocol	Modbus/TCP and Modbus/UDP (server)	
LED Indicator		
LED	2 LEDs: TR/LN (IR Transmitting/Learning) and PWR (Power)	
Power		
Connector	4-pin (F.G., N/A, +Vs, and GND) screw terminal connector	
Power supply	+10 ~ +30 V <sub>DC</sub>	
Power Consumption	Stand By	1.7 W
	Using 1 IR Output	3.4 W
	Using 2 IR Outputs	5.8 W (Max.)
Mechanical		
Installation	DIN-Rail Mounting	
Dimensions	52 mm x 27 mm x 85 mm (W x L x H)	
Dip Switch	OP (Normal operation) and FW / Init (Firmware update / Default Communication)	
Environmental		
Operating Temperature	-25 °C ~ +75 °C	
Storage Temperature	-30 °C ~ +80 °C	
Humidity	10 ~ 90% RH, non-condensing	

## 2.2 Appearance

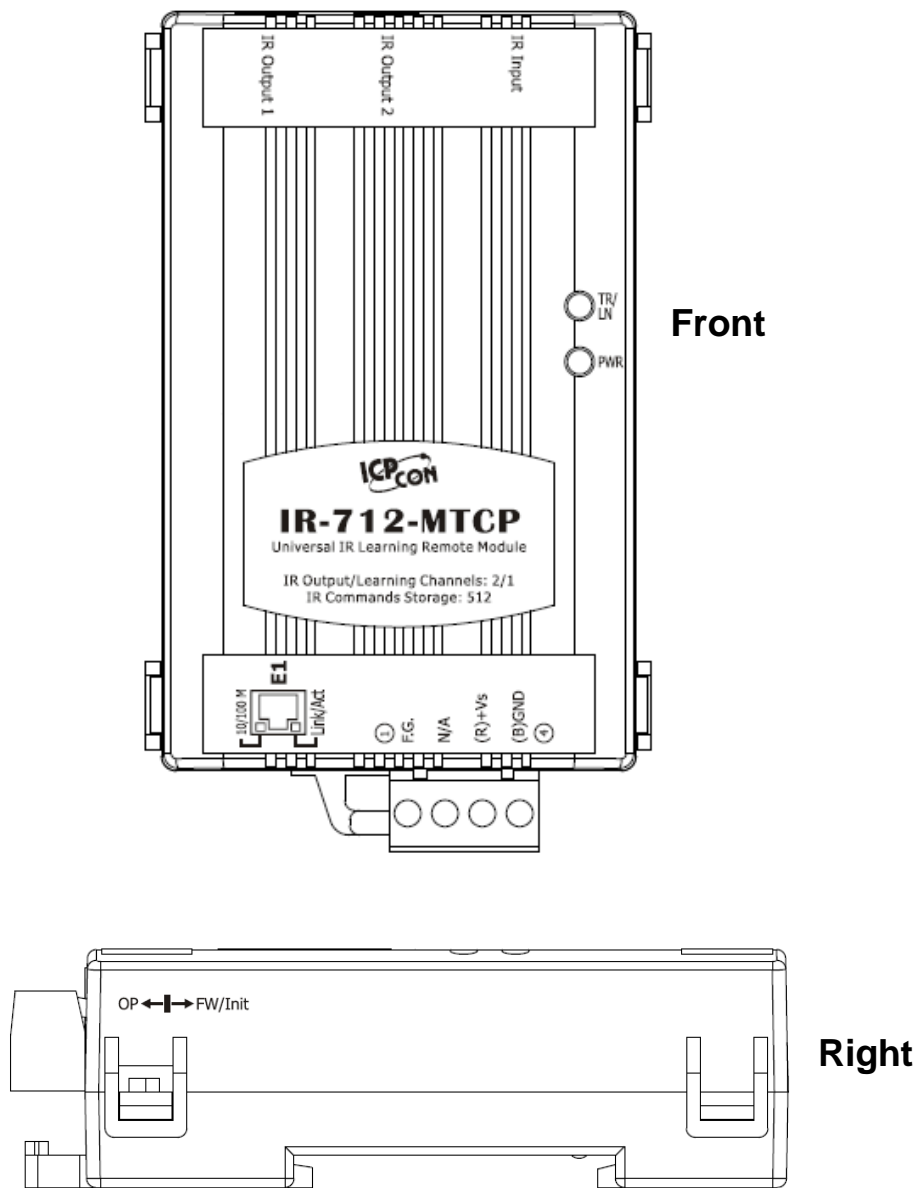

**Figure 2-1** The appearance of the IR-712-MTCP

## 2.3 Pin assignments

### ● The IR Output Jack

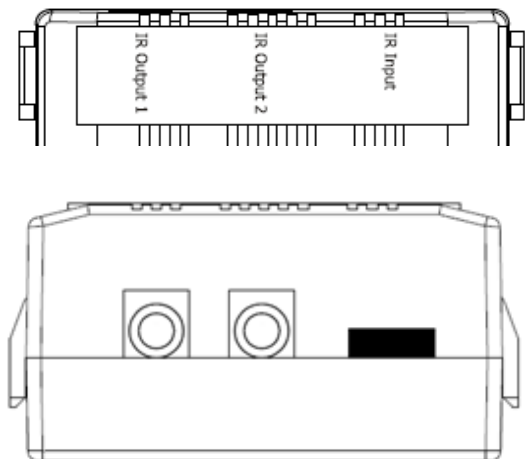

Figure 2-2 IR output 3.5 mm audio jack

Table 2-1 IR interface

IR Interface of the IR-712-MTCP	
IR Input	IR Input
IR Output (3.5 mm audio jack)	IR Output 1
	IR Output 2

### ● The terminal at the bottom

Table 2-2 IR-712-MTCP terminal pin assignments

Interface	Pin
Ethernet	E1
Power	GND
	+Vs
Frame Ground	F.G.

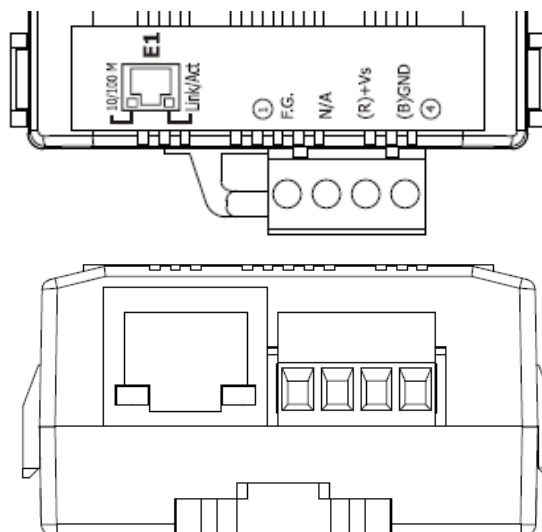

Figure 2-3 Communication terminal



---

## 2.4 Wire connection

The IR-712-MTCP provides one Ethernet communication port. Two IR outputs jacks on the front panel are for 3.5 mm audio jack plugs.

### 2.4.1 IR Output Jack

There are two IR output channels with 3.5 mm audio jacks at the upper side of the IR-712-MTCP. The IR-712-MTCP supports TRS and TS connection jack plugs. The figure 2-4 shows the relation of IR output and TRS connector. The figure 2-5 shows the relation of IR output and TS connector.

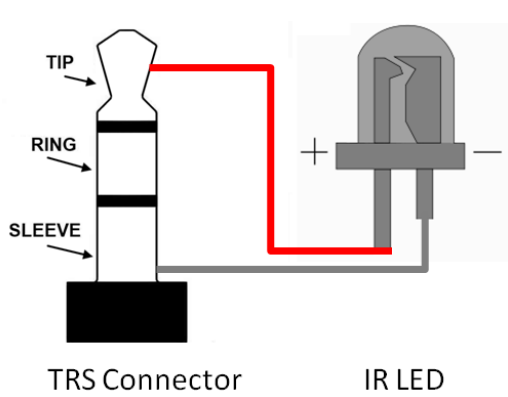

Figure 2-4 TRS connection

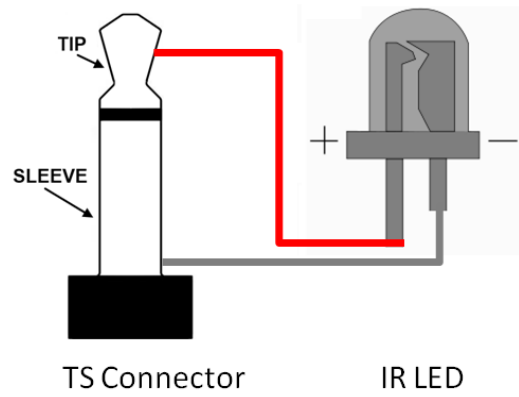

Figure 2-5 TS connection

### 2.4.2 Power connection

The IR-712-MTCP supports +10~+30 VDC. The power connection is shown in the figure 2-6.

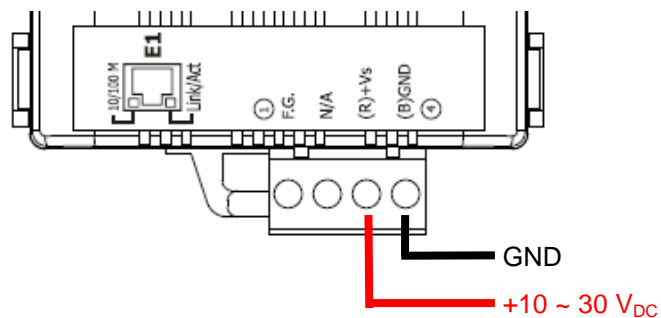

Figure 2-6 Power connection

---

## 2.5 Watchdog setting

The watchdog is the system inside timer to reset system due to some fault conditions causing system halted.. The watchdog of the IR-712-MTCP can be enabled or disabled by JP2. It is necessary to open the case of the IR-712-MTCP to set the JP2. The setting of JP2 is shown in the figure 2-7. The default of the watchdog is enabled.



**Figure 2-7** JP2 setting for Watchdog timer

---

## 2.6 DIP Switch for Firmware Update/Default Communication

There is a switch at the right side of the IR-712-MTCP case for the firmware update / default communication mode.

### 2.6.1 Update firmware / Default Communication

Please pull the dip switch to the FW/Init position as depicted in the Figure 2-8. Power cycle the IR-712-MTCP to enable the FW/Init mode. The TR/LN and PWR LEDs will both blink 6 seconds long (can start update firmware) and then go to the state with TR/LN LED off and PWR LED on. The module is in the default communication settings (basic settings) and can be updated firmware at this state.

(a) Please refer to the **Appendix A** for the procedure of firmware update.

**Note:** The basic settings and the stored IR commands will not be changed after the firmware update.

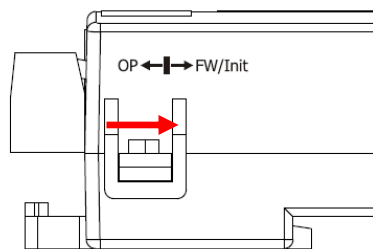

**Figure 2-8** DIP switch (FW/Init mode)

(b) The default basic settings

**Table 2-2** Default basic settings of the IR-712-MTCP

Default Communication Settings	
Address Type	Static IP
IP Address	192.168.255.1
Subnet Mask	255.255.0.0
Gateway	192.168.0.1
Modbus ID	1
Idle Timeout	0 ms (disable)
Default IR Learning Parameter	
GapTime	36 ms

---

## 2.6.2 Firmware operation mode

The firmware operation mode needs the DIP switch to be set to the “OP” position in the figure 2-9 and then power cycle the IR-712-MTCP. In this mode, users can use the custom basic settings.

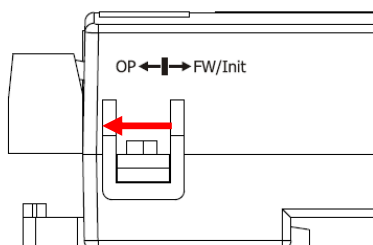

**Figure 2-9** *DIP switch (OP mode)*

## 2.7 LED Indicators

There are two LEDs in the IR-712-MTCP to show different states:

**Table 2-2** *Default basic settings of the IR-712-MTCP*

LED	IR-712-MTCP state	LED state
TR / LN	Emitting IR signal	ON during emitting IR
	IR learning mode ON	ON
	IR learning mode OFF	OFF
PWR	Power is normal.	ON
	Power is failed.	OFF
	MBTCP client connection	Blinks once every 2 seconds.
All LEDs	OP mode	TR/LN LED is OFF and PWR LED is ON. Note: Push the DIP switch to the <b>OP</b> position and power cycle the module.
	FW / Init mode	TR/LN & PWR LED are both blinking 6 seconds after power cycling. After that, TR/LN is OFF and PWR is ON. ° Note: Push the DIP switch to the <b>FW/Init</b> position and power cycle the module.

---

## 3. Software

### 3.1 Configuration tool– IR Utility

IR Utility is for setting the IR series modules. It is the .NET Framework 4.5 client profile program based on Microsoft Windows OS. IR-712-MTCP utility, contained in the IR utility, is for IR-712-MTCP to set parameters and learning IR commands. Users can download the IR Utility (IR\_Util\_Setup\_v#\_#\_#\_#.zip) from:

[ftp://ftp.icpdas.com/pub/cd/usbcd/napdos/ir/ir\\_utility/](ftp://ftp.icpdas.com/pub/cd/usbcd/napdos/ir/ir_utility/)

If the environment of .NET Framework 4.5 is not available in the Microsoft Windows OS, please download and install the redistributable packages as follows:

- Web Installer

<http://www.microsoft.com/en-US/download/details.aspx?id=30653>

- Offline Installer

<http://go.microsoft.com/fwlink/?LinkId=225702>

### 3.2 IR-712-MTCP Utility

IR utility can be launched from [Start] → [ICPDAS] → [IR Utility]. Select “IR-712-MTCP” in the Module combobox. The main window for searching the IR-712-MTCP will appear as shown in the Figure 3-1..

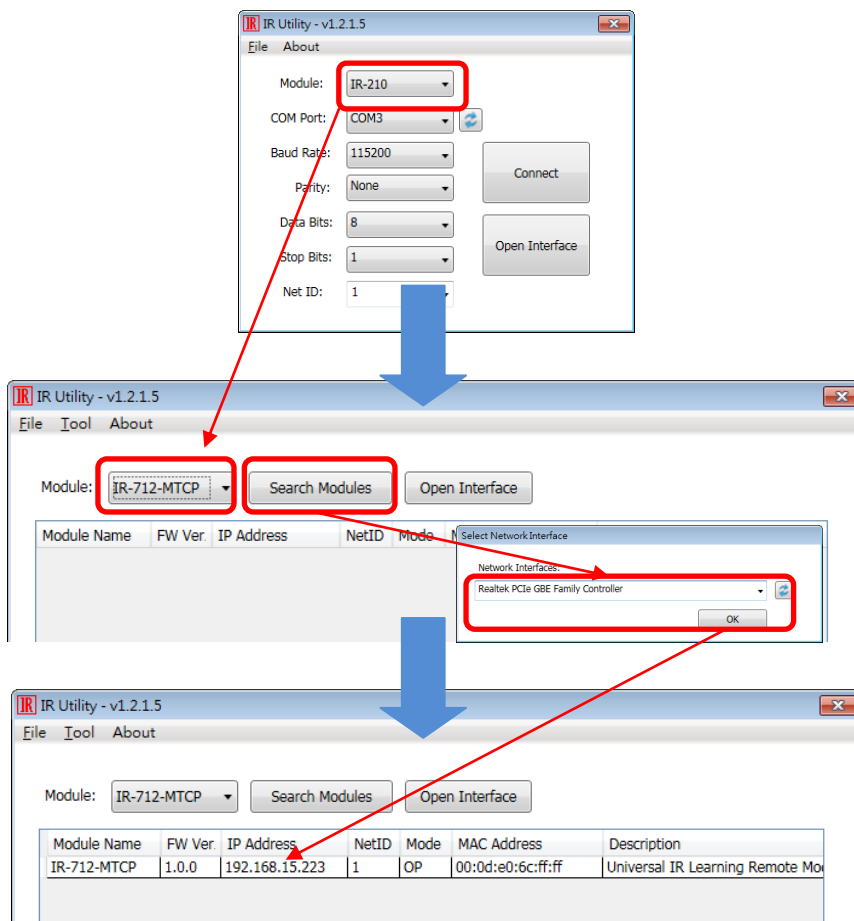

**Figure 3-1** Main windows of the IR utility for the IR-712-MTCP utility

### 3.2.1 Main Window of the IR-712-MTCP Utility

Continued from the main window of the IR utility in the Figure 3-1, where

1) “Search Modules” button:

For searching the IR-712-MTCP. The searched modules are listed in the underneath table. Mouse left double-clicking the item in the table can go to the main window of the IR-712-MTCP utility with the connection established.

2) “Open Interface” button:

Go to the main window of the IR-712-MTCP Utility but without connection to the module.

Search the IR-712-MTCP by pressing the “Search Modules” button. The utility will search the modules by the selected network interface. Double click the searched module in the underneath table to go to the main window of the IR-712-MTCP utility as shown in the Figure 3-2..

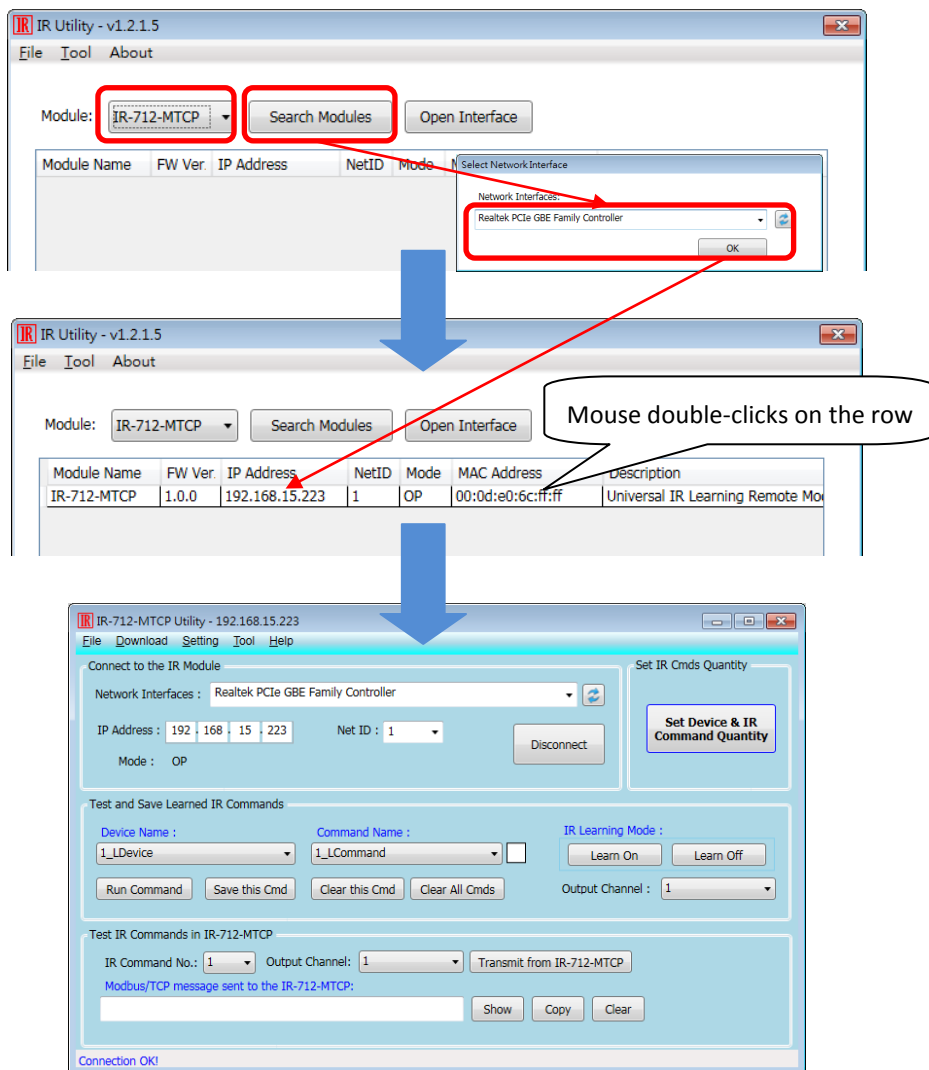

**Figure 3-2** Main window of the IR-712-MTCP Utility



---

### 3.2.2 Menu

Table 3-1 explains the menu of the IR-712-MTCP Utility.

**Table 3-1** *The items of menu.*

<b>Item</b>	<b>Sub item</b>	<b>Description</b>
File	Load IR Commands from File	Load the IR command file to the utility.
	Unload IR Commands	Unload the IR commands from the utility.
	Save IR Commands to File	Save the IR command to the defined file from the utility.
	Copy IR Commands from File	Copy part of an IR learning data file.
	Exit	Exit by the utility.
Download	Download IR Commands to IR-712-MTCP	Download the temporary IR commands of the utility to the flash memory of IR-712-MTCP.
	Load IR Commands from IR-712-MTCP	Load the temporary IR commands from the flash memory to the utility.
Setting	IR-712-MTCP Basic Settings	The basic settings of the IR-712-MTCP.
Tool	Update Firmware to IR-712-MTCP	This function provides users to update the firmware of the IR-712-MTCP.
Help	About IR-712-MTCP Utility	Version of utility and firmware.

#### (1) File

- **Load IR Command from File**

The saved file name is \*.ird which includes the information of the learned IR commands. Click this item would pop up the window for users to select the saved file. Then, the IR commands would be downloaded to the utility.

- **Unload IR Commands**

This function would clear the temporary IR commands from the utility. The “Device Name” and “Command Name” list in “Test and Save Learning Commands” field would be recovered to the default values

- **Save IR Commands to File**

This function provides a dialog to save the temporary IR commands as the defined file.

- **Copy IR Commands from File**

Click this item will appear a Copy window for copying part of an IR learning data file. It

---

can use the existing IR learning data files more effectively. Please note that the IR leaning data file of the IR-712-MTCP cannot be used by the IR-210/IR-712A. Please refer to the section 4.9 for more detail.

- **Exit**

Close the utility and back to the main window of the IR utility.

## (2) Download

- **Download IR Commands to IR-712-MTCP**

This function can save the IR learning commands buffered in the utility to the flash memory of the IR-712-MTCP. There will be a window appeared to show the download progress as shown in the figure 3-3.

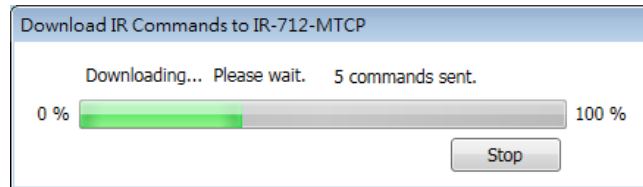

**Figure 3-3** Download the IR commands to the IR-712-MTCP.

- **Load IR Commands from IR-712-MTCP**

The item provides the function to load the IR commands to the utility from the IR-712-MTCP's flash memory. That would appear the window to show the download progress as shown in the figure 3-4.

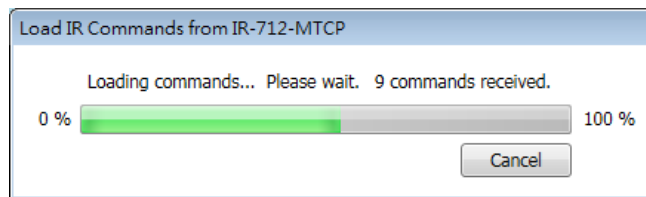
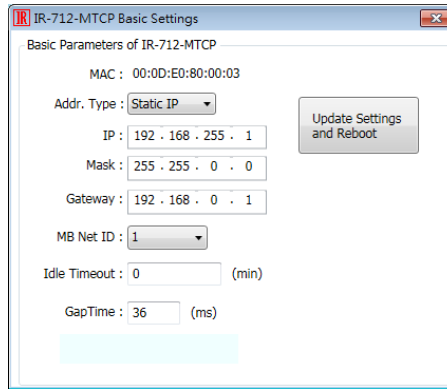

**Figure 3-4** Load the IR commands from the IR-712-MTCP.

## (3) Setting

- **IR-712-MTCP Basic Settings**

This item can get or set the basic settings of the IR-712-MTCP as shown in the Figure 3-5.



**Figure 3-5** The basic settings of the IR-712-MTCP.

These settings include “Communication Parameters” and “IR Learning Parameter” as shown in the Table 3-2.

**Table 3-2** IR-712-MTCP Basic Settings

Communication Parameters	Default value	Range
Address Type	Static IP	Static IP / DHCP <sup>(1)</sup>
IP Address	192.168.255.1	--
Subnet Mask	255.255.0.0	--
Gateway	192.168.0.1	--
Modbus ID	1	1 ~ 247
Idle Timeout	0 min (disabled)	0 ~ 65535 min <sup>(2)</sup>
IR Learning Parameter	Default value	Range
GapTime	72 ms	6 ~ 200 ms <sup>(3)</sup>

**Note:**

- (1) DHCP is only effective if there is a DHCP server in the local area network.
- (2) Idle Timeout is the time interval (0 ~ 65535 minutes) when no communication for the Modbus/TCP connection. After exceeding the timeout, IR-712-MTCP will close the connection. The default is 0 ms (disabled).
- (3) GapTime is the maximum space time in the IR protocol (6 ~ 65 ms; default: 36 ms) E.g.,the GapTime should be longer than 42 ms to learn the IR commands of the Sharp TV successfully. (Figure 3-6)

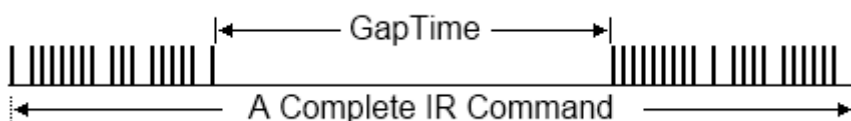

**Figure 3-6** The IR protocol with longer GapTime.

---

The parameters of the basic settings will be read back when opening the dialog of the Basic Settings. Press the “Update Settings and Reboot” button can change the basic settings and reboot the module.

#### **(4) Tool**

- **Update Firmware to IR-712-MTCP**

Open the “Update firmware” window. Please refer to the Appendix A for the firmware update.

#### **(5) Help**

- **About IR-712-MTCP Utility**

This item shows the version of the IR-712-MTCP utility and the firmware. The firmware version can be shown when connecting to the IR-712-MTCP.

---

### 3.2.3 Communication Interface (Connect/Disconnect)

If the IP address and Modbus net ID of the IR-712-MTCP are known, users can use the “Connect to the IR Module” section to connect to the module directly as shown in the Figure 3-7.

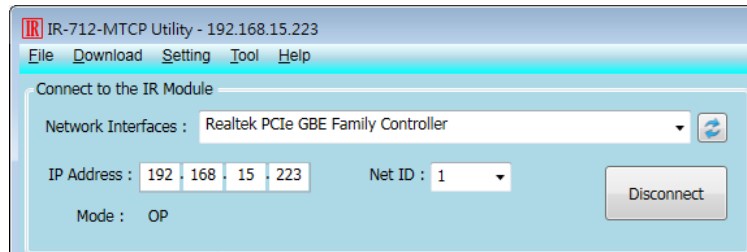

**Figure 3-7** Connect to the IR Module

### 3.2.4 Set Device & IR Command Quantity

The IR device & command quantity for IR learning can be configured in this interface. Please click “Set Device & IR Command Quantity” button (Fig. 3-8) to set them up in three steps (Fig. 3-9 ~ Fig. 3-12).

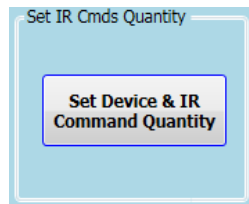

**Figure 3-8** Configure IR command quantity for learning.

- **Step 1 : Set the number of the IR devices.**

The maximum quantity of the IR controlled devices is 10. This function is convenient for users to set IR commands to different groups as shown in the figure 3-9.

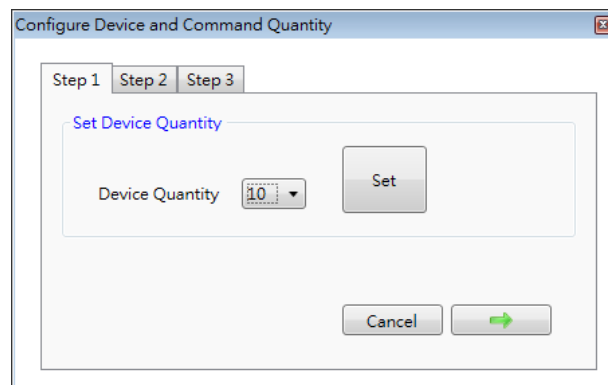
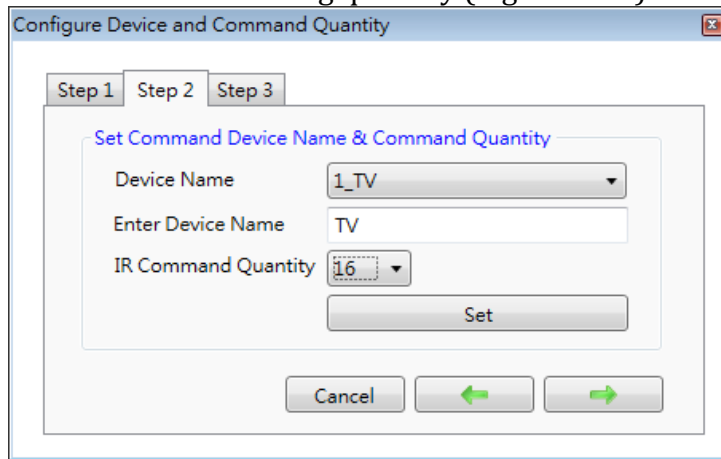

**Figure 3-9** The quantity setting of the device (Step1).

---

- **Step 2 : Define the device name and set the quantity of the IR commands**

This step can set the name of the IR controlled devices and the quantity of the IR commands (Figure 3-10). The prefix number is the number of the device. The quantity of the IR command cannot be over 512. When the number is over 512, the utility will appear a warning dialog and shows the remaining quantity (Figure 3-11).



**Figure 3-10** Define the name and the quantity of the IR commands (Step2)

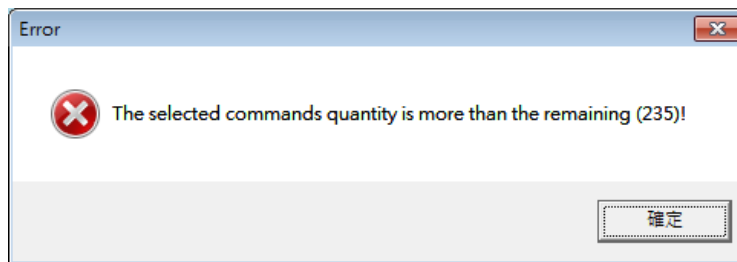

**Figure 3-11** The warning message dialog.

- **Step 3 : Define the IR command name**

This step can define the IR command names for convenience to know the IR command function. The prefix number of the name is the number of the IR command. This number is the reference to the IR commands stored in the IR-712-MTCP.

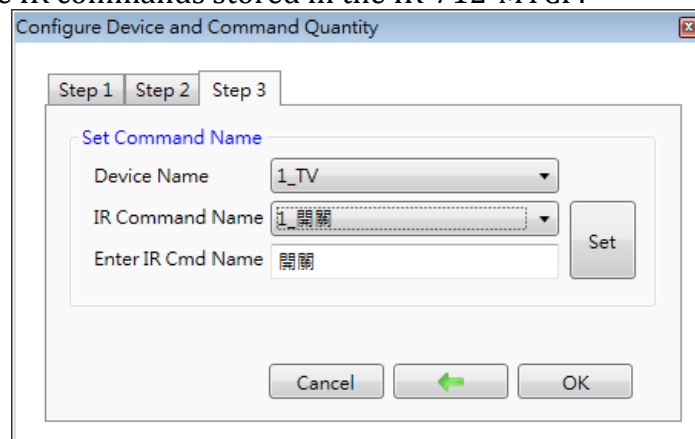
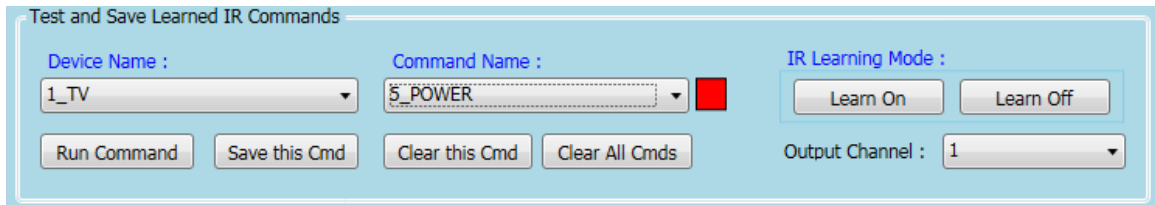

**Figure 3-12** Define the name of the IR commands (Step3)

---

### 3.2.5 Test and Save IR Learned Commands

This interface provides the function to enable the IR learning mode, buffer the IR learning data and test the learned IR commands as shown in the figure 3-13.



**Figure 3-13** Test & save learned IR commands interface

#### ➤ IR Learning Mode

This section (Figure 3-14) provides “Learn On” and “Learn Off” buttons. After clicking “Learn On” button, the IR-712-MTCP will go to the IR learning mode and the TR/LN LED is on to wait for the remote control’s IR signal. The “Learn Off” button can disable the IR learning mode.

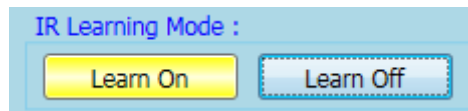

**Figure 3-14** Enable/Disable IR learning mode

#### ➤ Test and Save Learned Commands

The functions in this section are described as follows:



**Fig. 3-15** Test & save IR commands interface

- Device Name / Command Name combobox

After the device & IR command quantity are set, the configured names can be checked in the comboboxes of the “Device Name:” and “Command Name”. Users can do the IR learning according to these items.

- IR command learning state

The square block at the right side (Figure 3-16) indicates the storage state for the items of the current “Command Name” combobox. The states are listed in the Table 3-3.

**Table 3-3** *The states of IR command storage*

<b>Square Color</b>	<b>State Description</b>
Red	The learned IR command data has been saved in the item of the “Command Name” combobox. The data won’t be disappeared after selecting other items.
Yellow	Get the IR learned command temporarily. If other command name item has been selected, the data for the item would be disappeared.
White	No IR learning data.

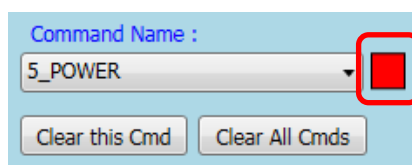

**Figure 3-16** *The IR learning state dialog*

- Run Command button

When finishing learning IR command, users can test and emit this IR command from the IR-712-MTCP by clicking “Run Command” button. The IR output channels are determined by the “Output Channel” combobox.

- Save this Cmd button

If no error in testing the learned IR command, press this button to save the learned data to the item of the “Command Name” combobox. After all IR commands’ learning are finished, users can select Menu [File]->[Save IR Commands to File] to backup them into a file. Or download them to the module by clicking Menu [Download]->[Download IR Commands to IR-712-MTCP].

- Clear this Cmd button

Clicking “Clear this Cmd” button can remove the learned IR command in the item of the “Command Name” combobox.

- Clear All Cmds

This button can clear all the learned IR commands in the Utility. The device and command names would not be changed. However, selecting [File]-[Unload IR Commands] will clear all commands and change the names and quantity of the device and IR command to the default values.

- Output Channel



---

The “Output Channel” combobox specifies the output channels of the IR signal when clicking the “Run Command” button.

### 3.2.6 Test the IR commands in IR-712-MTCP

This section (Fig. 3-17) can help users to test the IR commands saved in the IR-712-MTCP after downloading IR commands to IR-712-MTCP. Click the “Transmit from IR-712-MTCP” button to send a Modbus command to the IR-712-MTCP with the specified IR command number and the IR output channel. Meanwhile, a Modbus/TCP command text for reference is shown underneath. Users can click “Copy” button to copy the Modbus command to the clipboard and use it in programming their applications.

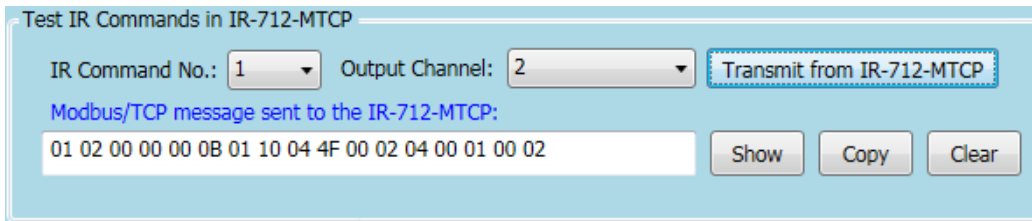

**Figure 3-17** Test IR commands saved in IR-712-MTCP.

---

## 4. Example of Learning IR commands

After the IR Utility connects to the IR-712-MTCP, please follow the subsequent sections to understand how to configure and learn IR commands by the IR-712-MTCP utility.

### 4.1 Connect to the IR-712-MTCP

The default basic settings parameters of the IR-712-MTCP are listed in Table 3-2. There are communication parameters and IR learning parameter.

Please refer to Figure 4-1 for the steps of utility connecting to the IR-712-MTCP:

- (1) Search modules: Press the “Search Modules” button.
- (2) Select the network interface which can communicate with the module and press OK.
- (3) Mouse double-clicks the row of the searched modules.
- (4) Appear the main window of the IR-712-MTCP utility and with the module connected.

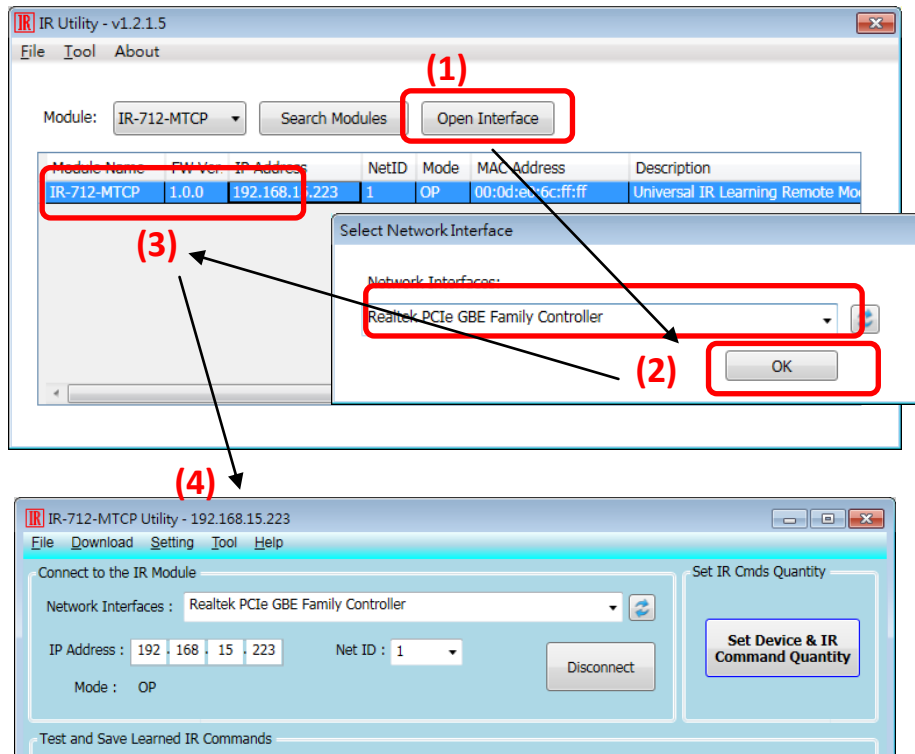

**Figure 4-1** Search the module and connect.

## 4.2 Configure the quantity of the IR commands

Click the “Set Device & IR Command Quantity” button at top-right corner (Fig. 4-2) to open the configuration dialog. Follow three steps below to finish the configuration of the devices and IR commands quantity in advance of the next IR learning.

**Step 1 :** Set the quantity of the IR-controlled devices as shown in fig. 4-3.

**Step 2 :** Set the device name and the quantity of the IR commands as the fig. 4-4.

**Step 3 :** Set the IR command names as depicted in fig. 4-5.

The prefix numbers of these IR command names (e.g. 1\_Play) represent the numbers of 512 IR commands saved in the IR-712-MTCP module. They will be used as IR command number in the Modbus command for communication with IR-712-MTCP.

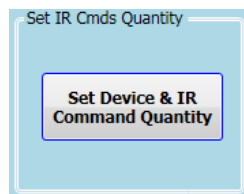

**Figure 4-2** The button for configuration of IR command quantity.

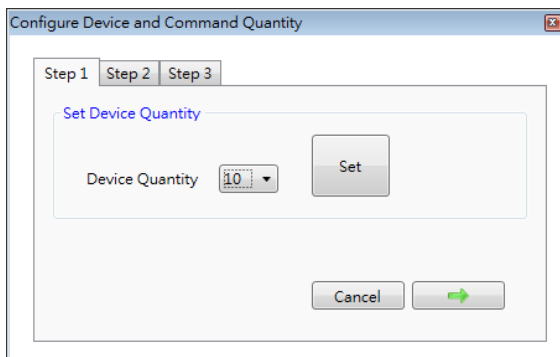

**Figure 4-3** Set Device quantity.



**Figure 4-4** Set device names & IR cmd quantity.

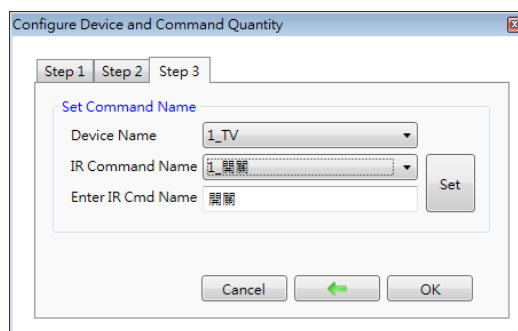

**Figure 4-5** Set names of IR commands.

### 4.3 Learning and Testing IR commands

Follow the steps below and the illustration in figure 4-6 to learn and test IR commands:

- (1) Determine the IR command for learning by selecting the items in the “Device Name” and “Command Name” comboboxes.
- (2) Click the “Learn On” button to enable the IR learning mode on the IR-712-MTCP. At the same time, the TR/LN LED is turned on to show the Learn On state.
- (3) Aim the IR emitter head of the device’s remote control at the IR input of IR-712-MTCP. The distance less than 3 cm between the remote control and the IR-712-MTCP would be best. Then, press the button of the remote control which is to be learned. If the learning for the IR command is finished, the TR/LN LED will be turned off.
- (4) Select the IR output channel. For example in the figure 4-6, the IR output channel is 1.
- (5) Aim the head of the IR emitter cable plugged in the IR output 1 at the corresponding IR-controlled appliance. Click “Run Command” button to emit the IR command from the IR-712-MTCP. You can check if the learned IR command is OK by investigate the action of the appliance. If not, please repeat step 2 and step 3 again.
- (6) Click “Save this Cmd” button to save this IR learning command to the current item of the “Command Name” combobox, e.g. the item is “Play” in figure 4-6.
- (7) Repeat the above steps (1) ~ (6) to learn all the IR commands.

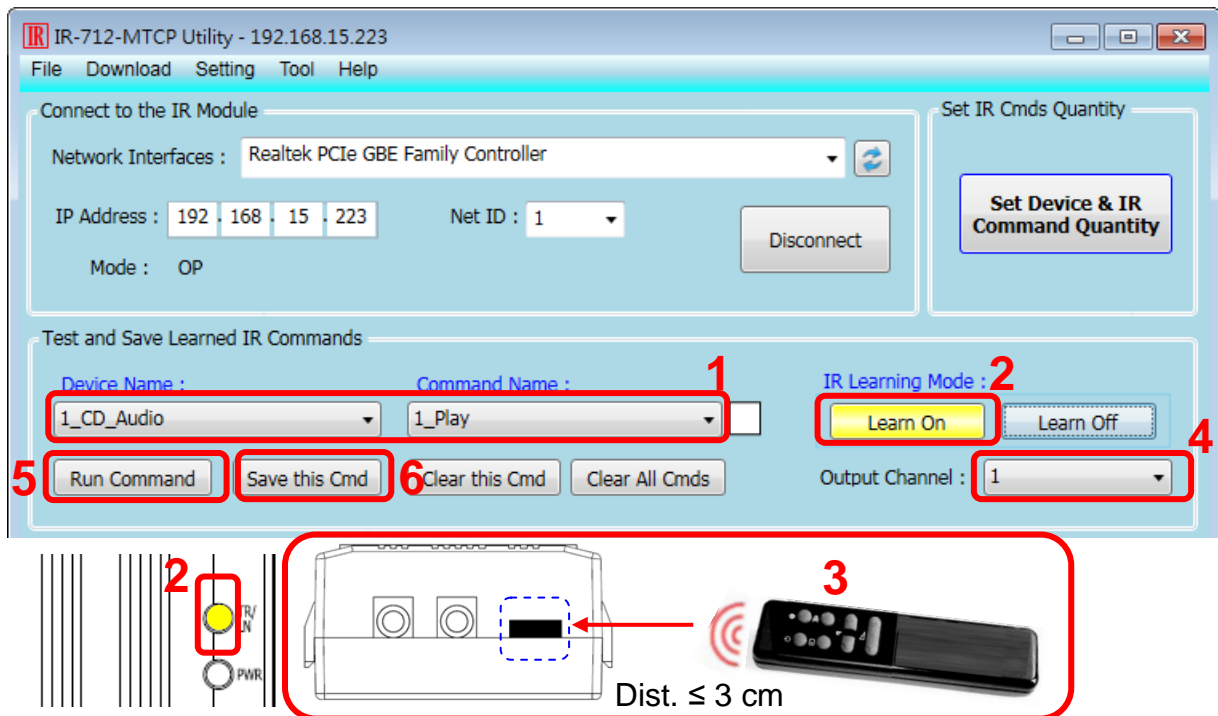

Figure 4-6 The steps to learn IR commands.

---

When the IR learning process is finished, it is advised to save these learning data into a file for backup by clicking [File] in menu. Besides, it is necessary to download these learned IR commands to the IR-712-MTCP by selecting the [Download]->[Download IR Commands to IR-712-MTCP] in the menu.

#### 4.4 Saving the Learned IR Commands to a File

Click [File]->[Save IR commands to file] to save the learned IR commands as a file. The extension of the file name is \*.ird.

#### 4.5 Download the IR Learning Commands

After the learning IR command procedure or loading learning data from the file, it is necessary to download these learning data to the IR-712-MTCP by clicking [Download]-> [Download IR Commands to IR-712-MTCP] in the menu and a progress window will appear as shown in figure 4-7.

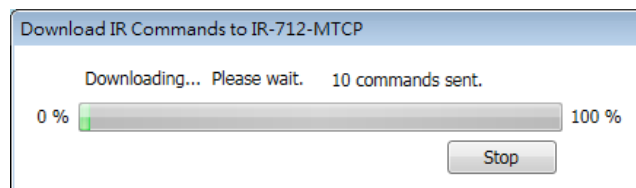
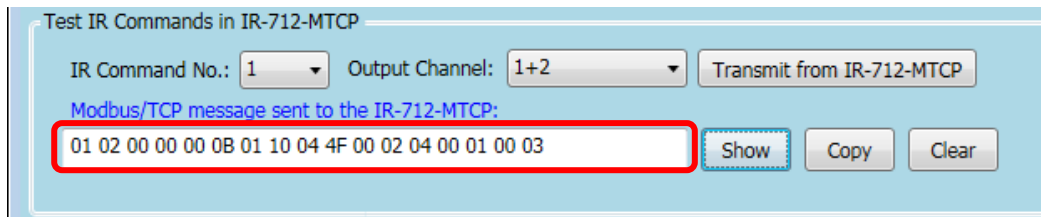

**Figure 4-7** Download the learned IR command to the IR-712-MTCP

#### 4.6 Test the IR commands saved in the IR-712-MTCP

The section of the “Test IR Commands in IR-712-MTCP” can help users to test the learned IR commands stored in the IR-712-MTCP as shown in figure 4-8. By clicking “Transmit from IR-712-MTCP” button, the specified IR command (the prefix no. explained in 4.2) would be emitted from the selected output channel of the module. You can check if the learned IR command is correct in this way.

At the same time, the Modbus/TCP message sent to the IR-712-MTCP is shown in the underneath textbox. This Modbus message is a reference for users to help program the application to control the IR-712-MTCP.



**Figure 4-8** Test the IR commands saved in the IR-712-MTCP

## 4.7 Load the IR Learning Commands from the File

Select [File]->[Load IR Commands from File] in the menu to load IR learning data into the IR-712-MTCP Utility from the \*.ird files.

## 4.8 Load IR Learning Commands from the Module

Select [Download]->[Load IR Commands from IR-712-MTCP] in the menu to load the IR commands from the IR-712-MTCP. A progress window will appear as shown in figure 4-9.

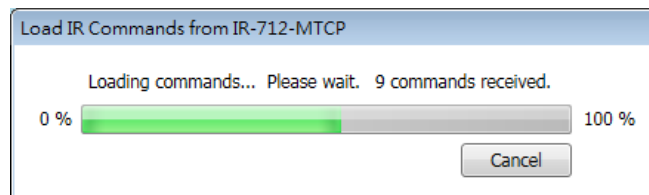
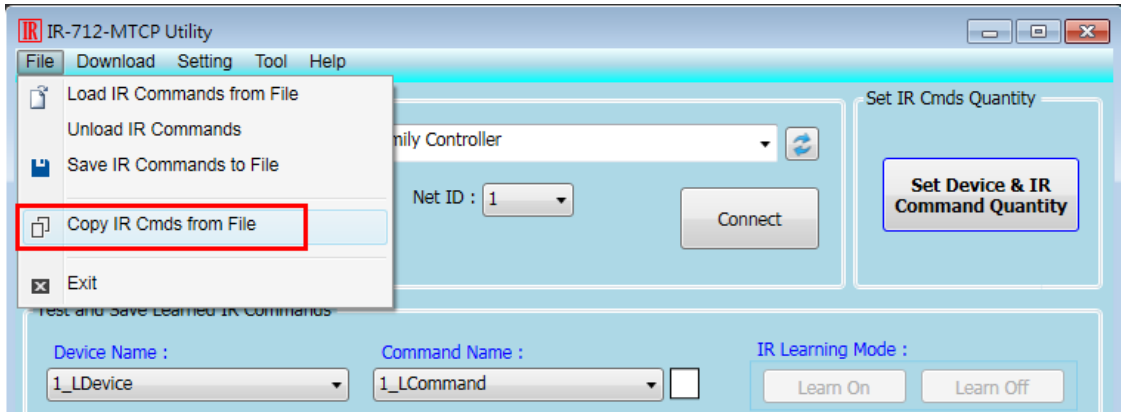

**Figure 4-9** Load the IR commands from the IR-712-MTCP

## 4.9 Copy IR commands from other IR learning data files

Use this function to load the part commands of an IR learning data file. It can use the existing IR learning data file more effectively to avoid learning IR commands again.

(1) Mouse clicks [File]->[Copy IR Cmds from File]

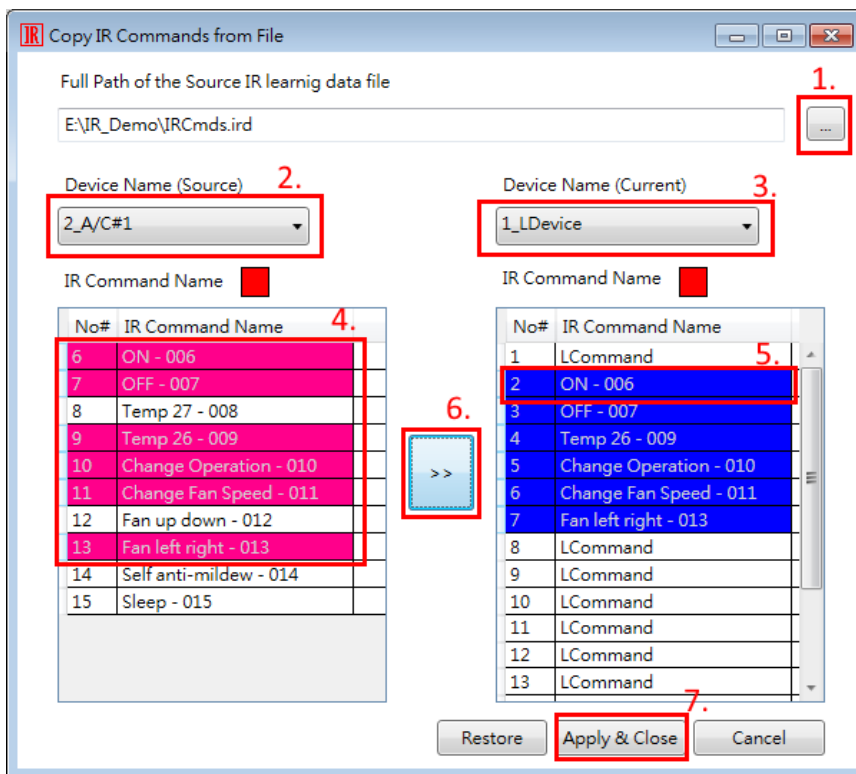

**Figure 4-10** Open the Copy IR Cmds window

(2) Please refer to the steps depicted in the figure 4-11 :

1. Open source IR learning data file (\*.ird) .
2. Select the device name of the source IR leaning data.
3. Select the device name of the current IR leaning data.
4. Select (can multi-select) the source IR commands for copy.
5. Select (only single-select) the current IR command as the start position of copy.
6. Press the copy button (>>).
7. Press the “Apply & Close” button to finish the copy action.

The “Restore” button can restore the current IR commands after pressing the copy button.



**Figure 4-11** Step 1~7 for copying IR commands.

(3) Back to main window to see the copy result as shown in the figure 4-12.

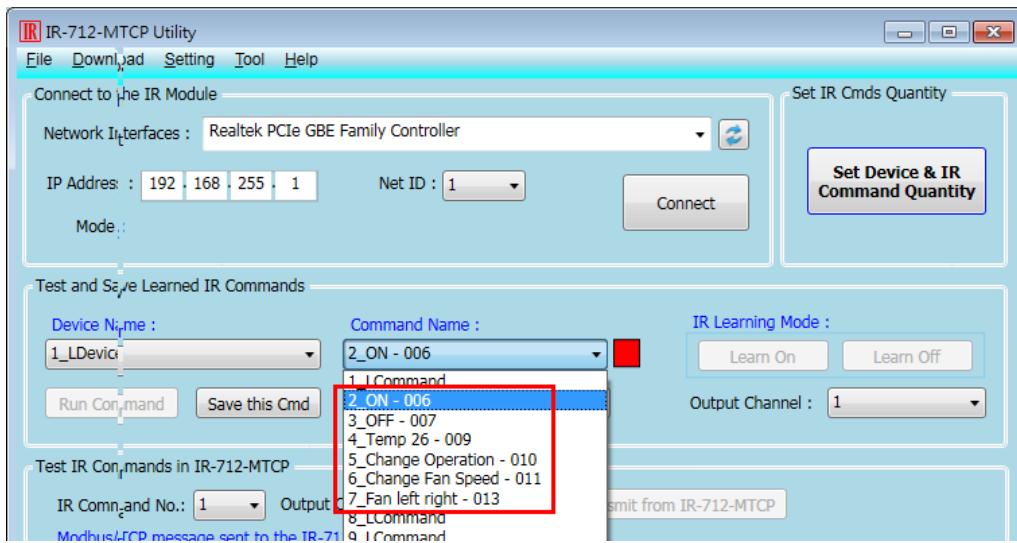

**Figure 4-12** Result of copying IR commands.



## 5. Modbus Registers Addresses

Table 5-1 is the description of the Modbus holding registers (4xxxx) for the IR-712-MTCP. The Modbus client device can send Modbus commands to the IR-712-MTCP to emit the IR commands from the output channels. The function codes (FC) of Modbus to write data to Modbus registers are 6 and 16. Each Modbus address occupies 2 bytes.

**Table 5-1** *Modbus Holding Registers in the IR-712-MTCP*

Start Address [4xxxx]	Description
1103 (0x44F) [41104]	The number of IR command (1 ~ 512)
1104 (0x450) [41105]	<p>IR output channels. Valid value: 0x01 ~ 0x03 ° The first bit (LSB) of the value represents the 1<sup>st</sup> channel. The 2<sup>th</sup> bit represents the 2<sup>th</sup> channel.</p> <p>Example :</p> <ul style="list-style-type: none"> <li>• The 1<sup>st</sup> output channel : 0x01 == <u>01</u> (Binary)</li> <li>• The 1<sup>st</sup> and 2<sup>nd</sup> output channels : 0x03 == <u>11</u>(Binary)</li> </ul>

Table 5-2 is the example of a Modbus FC16 command to emit IR signal from the IR-712-MTCP. (Modbus ID:1, IR command No.:1, IR output channel: 2)

**Table 5-2:** *An example of Modbus FC16 Command for the IR-712-MTCP*

Request		Response	
Field Name	Hex Value	Field Name	Hex Value
MBAP Header	01	MBAP Header	01
	02		02
	00		00
	00		00
	00		00
	0B		06
Unit Identifier (Net ID)	01	Unit Identifier (Net ID)	01
Function Code	10	Function Code	10
Starting Address Hi	04	Starting Address Hi	04
Starting Address Lo	4F	Starting Address Lo	4F
Word Count Hi	00	Word Count Hi	00
Word Count Lo	02	Word Count Lo	02
Byte Count	04	--	--
IR command number Hi	00	--	--
IR command number Lo	01	--	--
IR output channel Hi	00	--	--
IR output channel Lo	02	--	--

The following is an example of using Modbus FC6 commands for IR-712-MTCP, where [41104] and [41105] should be written sequentially. (Modbus ID:1, the IR command No.:1, output channel: 1 + 2) (See Table 5-2 & Table 5-3)

**Table 5-2: An example of Modbus FC6 Command (address [41104])**

Field Name		Hex Value	
Field Name	Hex Value	Field Name	Hex Value
MBAP Header	01	MBAP Header	01
	02		02
	00		00
	00		00
	00		00
	06		06
Unit Identifier (Net ID)	01	Unit Identifier (Net ID)	01
Function Code	06	Function Code	06
Starting Address Hi	04	Starting Address Hi	04
Starting Address Lo	4F	Starting Address Lo	4F
IR command number Hi	00	IR command number Hi	00
IR command number Lo	01	IR command number Lo	01

**Table 5-2: An example of Modbus FC6 Command (address [41105])**

Field Name		Hex Value	
Field Name	Hex Value	Field Name	Hex Value
MBAP Header	01	MBAP Header	01
	02		02
	00		00
	00		00
	00		00
	06		06
Unit Identifier (Net ID)	01	Unit Identifier (Net ID)	01
Function Code	06	Function Code	10
Starting Address Hi	04	Starting Address Hi	04
Starting Address Lo	50	Starting Address Lo	50
IR command number Hi	00	IR command number Hi	00
IR command number Lo	03	IR command number Lo	03

Note:

(1) MBAP header: Modbus Application Protocol header.

---

## 6. Technical support

Please contact us if you have any questions about products.

ICP DAS website: <http://www.icpdas.com>

Email: [service@icpdas.com](mailto:service@icpdas.com)

---

## Appendix A Update Firmware

Please get the new firmware file in the following link:

<ftp://ftp.icpdas.com/pub/cd/usbcd/napdos/ir/ir-712-mtcp/firmware/>

### ■ Steps of updating firmware

- (1) Push the DIP switch to the location of “FW/Init” (Figure A-1) and power cycle the IR-712-MTCP.
- (2) Click the “Search Modules” button to search the IR-712-MTCP (Figure A-2) .
- (3) Mouse selects the searched module in the table.
- (4) Click [Tool]->[Update Firmware to the IR-712-MTCP] to open the update dialog.
- (5) Select the firmware file (ir712mtcp\_v###.dat).
- (6) Press the “Update Firmware” button.
- (7) A Console window appears to finish the update progress 100% (Figure A-3).

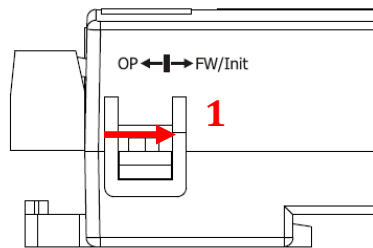

Figure A-1

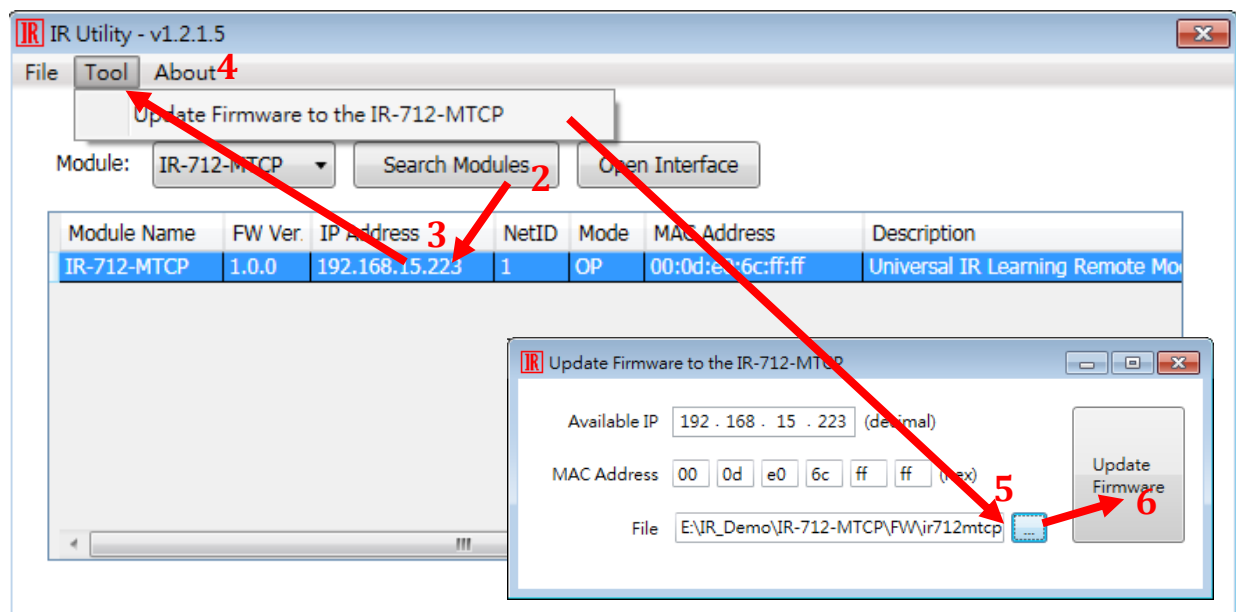
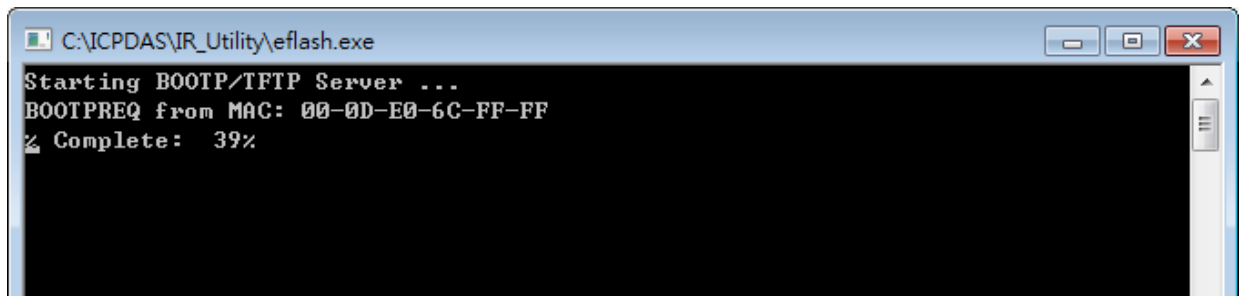

Figure A-2



**Figure A-3**

After the firmware update, push the DIP switch back to the “OP” position and power cycle the module.