



# LA4708

## 20 W 2-channel BTL AF Power Amplifier for Car Stereos

### Overview

The LA4708 is a BTL two-channel power IC for car audio developed in pursuit of excellent sound quality. Low-region frequency characteristics have been improved through the use of a new NF capacitorless circuit, and crosstalk which causes “muddy” sound has been reduced by improving both circuit and pattern layout. As a result, the LA4708 provides powerful bass and clear treble. In addition, the LA4708 features on-chip protectors and standby switch. The LA4708 is also pin-compatible with the LA4705NA (car stereo-use 17 W two-channel power IC), and can be substituted for the LA4705NA for higher power. (When the board is shared, pins 1 and 9 must be left open.)

### Features

- High power: supports total output of 30 W + 30 W ( $V_{CC} = 13.2$  V, THD = 30%,  $R_L = 4 \Omega$ )
- Supports  $R_L = 2 \Omega$  ( $P_O = 30$  W when  $V_{CC} = 13.2$  V, THD = 10%)
- Designed for excellent sound quality ( $f_L < 10$  Hz,  $f_H = 130$  kHz)
- NF capacitorless
- Any on time settable by external capacitor
- Less pop noise
- Standby switch circuit on chip (microprocessor supported)
- Various protectors on chip (output-to-ground short/output-to- $V_{CC}$  short/load short/overvoltage/thermal shutdown circuit)

### Package Dimensions

unit: mm

#### 3109-SIP18H

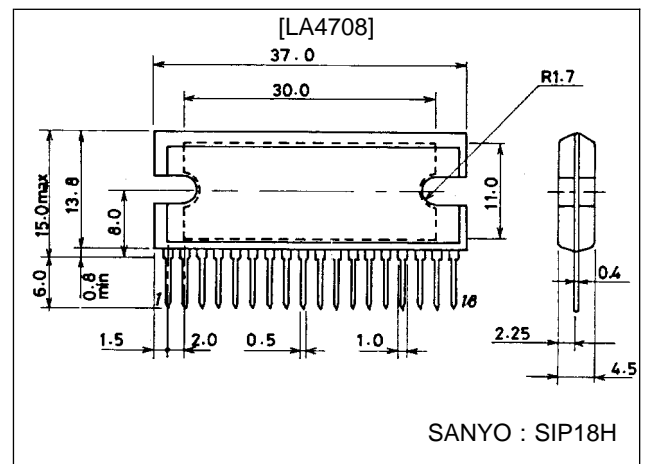

■ Any and all SANYO products described or contained herein do not have specifications that can handle applications that require extremely high levels of reliability, such as life-support systems, aircraft's control systems, or other applications whose failure can be reasonably expected to result in serious physical and/or material damage. Consult with your SANYO representative nearest you before using any SANYO products described or contained herein in such applications.

■ SANYO assumes no responsibility for equipment failures that result from using products at values that exceed, even momentarily, rated values (such as maximum ratings, operating condition ranges, or other parameters) listed in products specifications of any and all SANYO products described or contained herein.

## Specifications

### Maximum Ratings at Ta = 25°C

Parameter	Symbol	Conditions	Ratings	Unit
Maximum supply voltage	V <sub>CC</sub> max 1	No signal, t = 60 s	24	V
	V <sub>CC</sub> max 2		16	V
Surge supply voltage	V <sub>CC</sub> surge	t ≤ 0.2 s, single giant pulse	50	V
Maximum output current	I <sub>O</sub> peak	Per channel	4.5	A
Allowable power dissipation	Pd max	Arbitrarily large heat sink	37.5	W
Operating temperature	Topr		-35 to +85	°C
Storage temperature	Tstg		-40 to +150	°C

\* Set V<sub>CC</sub>, R<sub>L</sub> in a range that does not exceed Pd max = 37.5 W

### Operating Conditions at Ta = 25°C

Parameter	Symbol	Conditions	Ratings	Unit
Recommended supply voltage	V <sub>CC</sub>		13.2	V
Operating voltage range	V <sub>CC</sub> op	Range where Pd max is not exceeded	9 to 16	V
Recommended load resistance	R <sub>L</sub>		4	Ω
Recommended load resistance range	R <sub>L</sub> op		2 to 4	Ω

### Operating Characteristics at Ta = 25°C, V<sub>CC</sub> = 13.2 V, R<sub>L</sub> = 4 Ω, f = 1 kHz, Rg = 600 Ω

Parameter	Symbol	Conditions	min	typ	max	Unit
Quiescent current	I <sub>CCO</sub>		70	150	250	mA
Standby current	I <sub>st</sub>			10	60	μA
Voltage gain	VG		38	40	42	dB
Total harmonic distortion	THD	P <sub>O</sub> = 2 W		0.07	0.4	%
Output power	P <sub>O1</sub>	THD = 10%	16	20		W
	P <sub>O2</sub>	THD = 10%, V <sub>CC</sub> = 14.4 V		24		W
	P <sub>O3</sub>	THD = 10%, R <sub>L</sub> = 2 Ω		30		W
Output offset voltage	V <sub>N</sub> offset	Rg = 0	-300		+300	mV
Output noise voltage	V <sub>NO</sub>	Rg = 0, B.P.F. = 20 Hz to 20 kHz		0.1	0.5	mVrms
Ripple rejection ratio	SVRR	Rg = 0, f <sub>R</sub> = 100 Hz, V <sub>R</sub> = 0 dBm	40	50		dB
Channel separation	CHsep	Rg = 10 kΩ, V <sub>O</sub> = 0 dBm	50	60		dB
Input resistance	r <sub>i</sub>		21	30	39	kΩ
Standby pin applied voltage	V <sub>st</sub>	Amp on, applied through 10 kΩ	2.5		V <sub>CC</sub>	V

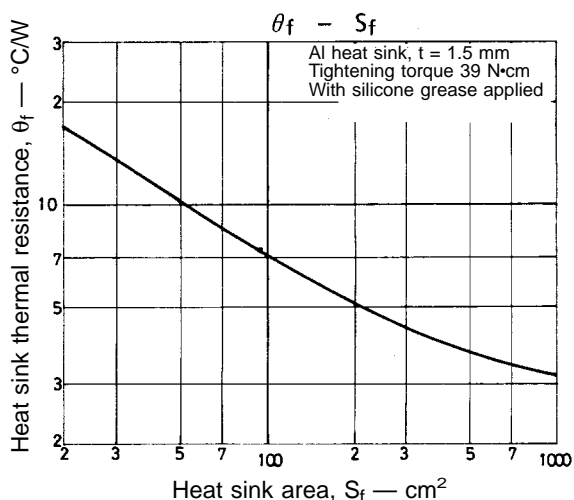
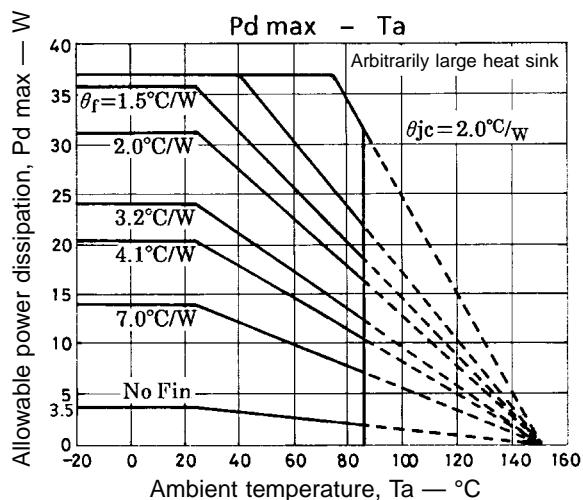

Equivalent Circuit Block Diagram

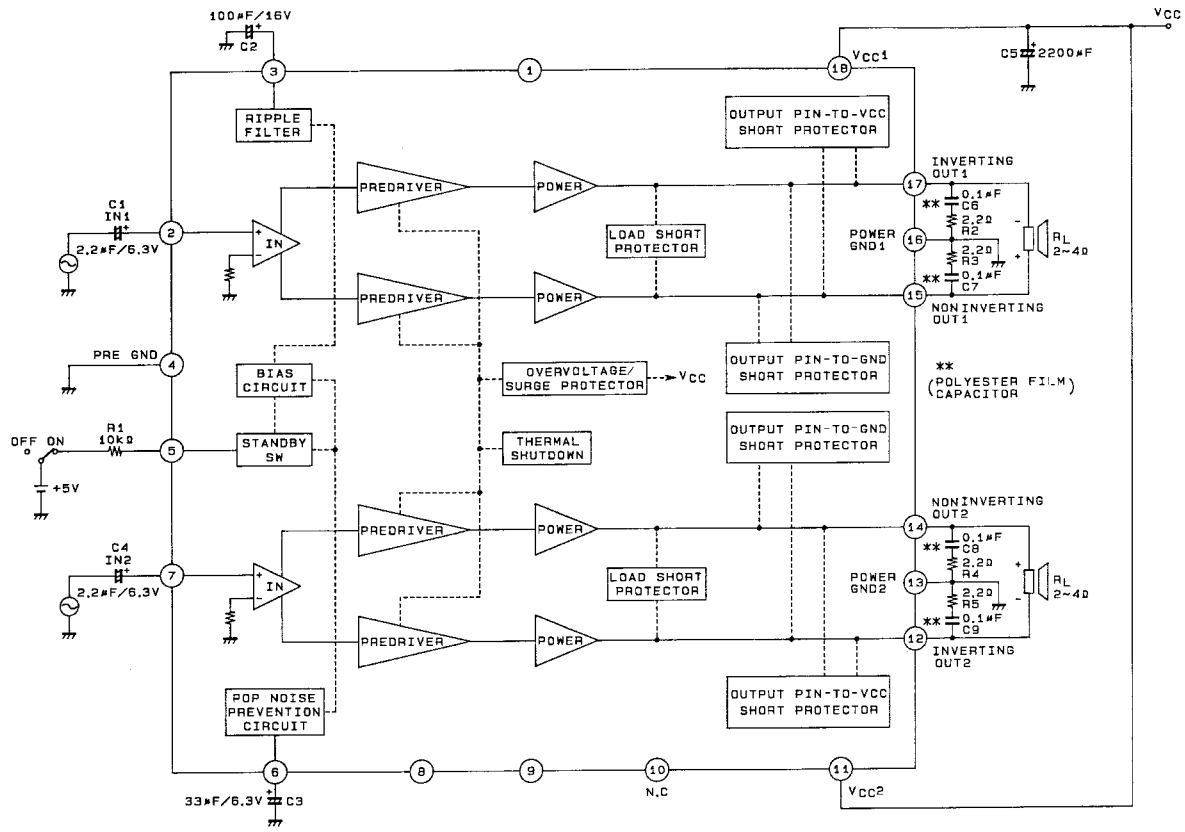

Pins 1,9 : Don't use  
Pin 10 : No connection

A04699

Each Pin Voltage

$V_{CC} = 13.2\text{ V}$ ,  $5\text{ V}$  applied through  $STBY = 10\text{ k}\Omega$ ,  $R_L = 4\ \Omega$ ,  $R_g = 0$

Pin No.	1	2	3	4	5	6
Name		IN1	DC	Pre-GND	STBY	ON TIME
Pin voltage (V)	0.29	1.58	6.55	0	3.2	2.28
Pin No.	7	8	9	10	11	12
Name	IN2	POP	-	N.C	$V_{CC2}$	-OUT 2
Pin voltage (V)	1.58	2.08	0.29	0	13.2	6.5
Pin No.	13	14	15	16	17	18
Name	PWR-GND 2	+OUT 2	+OUT 1	PWR-GND 1	-OUT 1	$V_{CC1}$
Pin voltage (V)	0	6.5	6.5	0	6.5	13.2

Sample Print Pattern

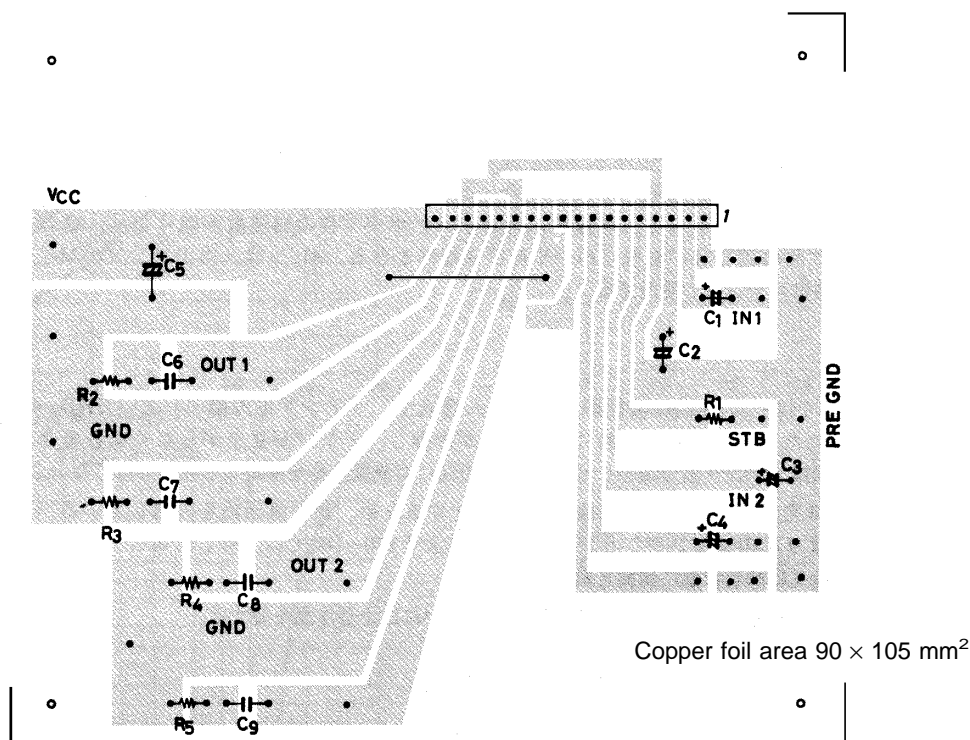

Description of External Components

C1, C4	Input capacitors	2.2 μF is recommended. $f_L$ can be varied by C1, C4 capacitances to adjust the bass range.
C2	Decoupling capacitor (ripple filter)	
C3	Amplifier on time setting capacitor	Approximately 0.8 second for 33 μF. Since the on time is proportional to this capacitance, it can be set as desired by varying this capacitance. (Refer to the characteristics curve.)
C5	Power supply capacitor	
C6, C7, C8, C9	Oscillation blocking capacitors	Use polyester film capacitors (Mylar capacitors) with good temperature characteristics. (R2, R3, R4, and R5 used jointly.) Since stability may be affected slightly by the pattern layout, etc., 0.1 μF or more is recommended.
R1	Standby switch current limiting resistor	10 kΩ is recommended (when the applied voltage for the standby switch is 2.5 V to 13.2 V). This resistor cannot be removed.

## Features of IC Inside and Usage Notes

### Standby function

- Pin 5 is the standby switch pin. The amplifier is turned on by applying approximately 2.5 V or more to this pin through an external resistor (R1).
- If voltage in excess of 13.2 V is to be applied to the standby switch, calculate the value of R1 using the following formula so that the current flowing into pin 5 is 500  $\mu$ A or less:

$$R1 = \frac{\text{Applied voltage} - 1.4 \text{ V}}{500 \mu\text{A}} - 10 \text{ k}\Omega$$

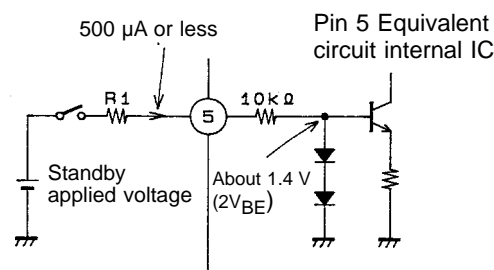

A04589

### Mute function

- Pin 6 is the connector for the capacitor that determines the on time in order to prevent pop noise. By grounding this pin, the amplifier can implement mute operation. In this case, the recovery time depends on C3.

### How to reduce pop noise

- Although the LA4708 reduces pop noise, an electrolytic capacitor of between 0.47 and 2.2  $\mu$ F can be connected between pin 8 and the pre-GND to further reduce pop noise that occurs when power supply is turned on/off (standby switch on/off). The larger the capacitance, the lower the frequency of pop noise, and it is barely audible, but sound residue of the sound signal is liable to linger when power is turned off. Pin 8 is the bias pin for the output amplifier and normally is left open.

### Protectors

- In an output-to-ground and output-to- $V_{CC}$  short protector system configuration, if a DC resistor is connected between amplifier output pin and GND, the protector may operate, causing the amplifier not to start operating. Therefore, as a general rule, no DC resistor should be connected between amplifier output pin and GND.
- In order to prevent damage or degradation which may be caused by abnormally heated IC, the LA4708 has a thermal shutdown protector. Accordingly, if the IC junction temperature ( $T_j$ ) climbs to around 170 to 180°C due to inadequate heat dissipation, the thermal shutdown protector will operate to control the output gradually into attenuation.
- Also be fully careful of handling other protectors built in the LA4708.

### Miscellaneous

- Since pins 1 and 9, which are unused, are connected internally, they must be left open.
- Pin 10 is an NC pin (no internal connection).

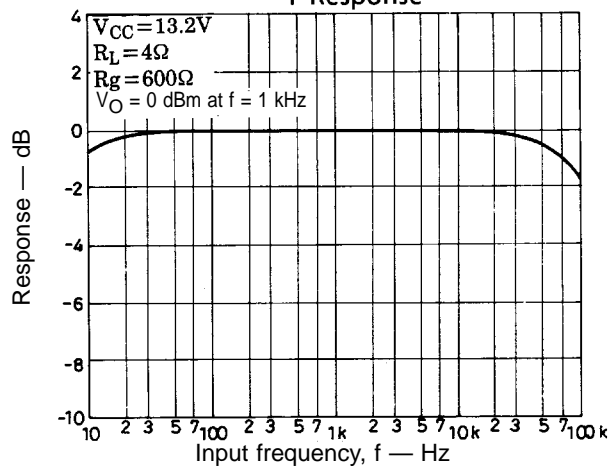
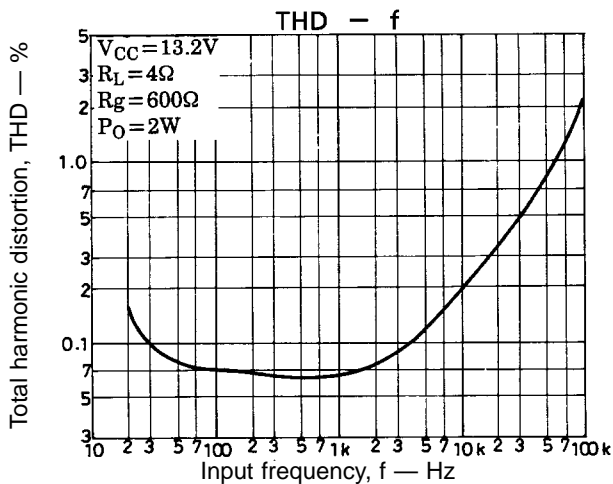
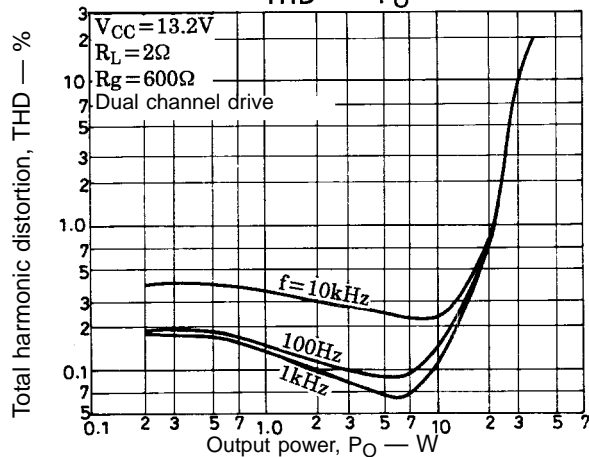
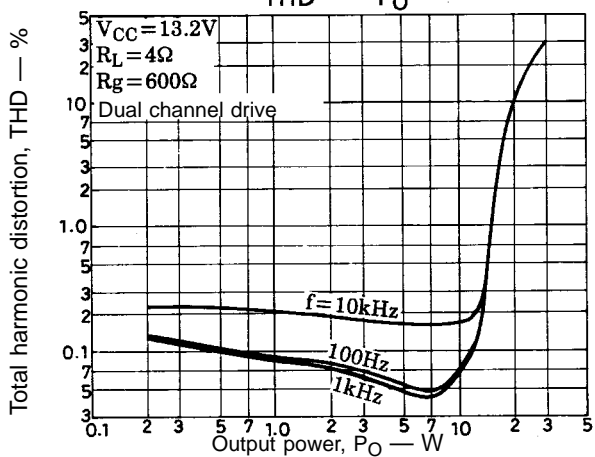
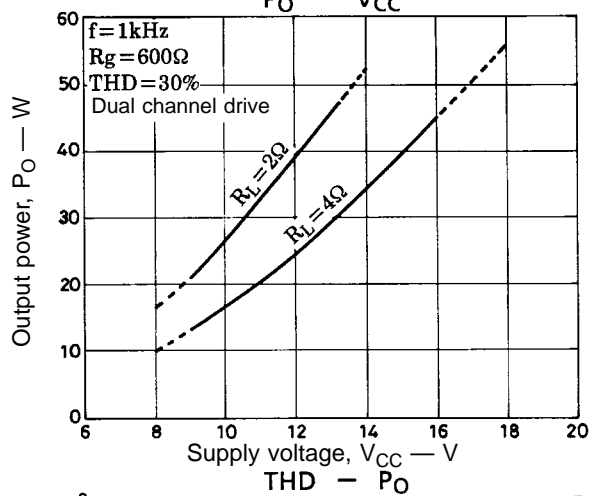
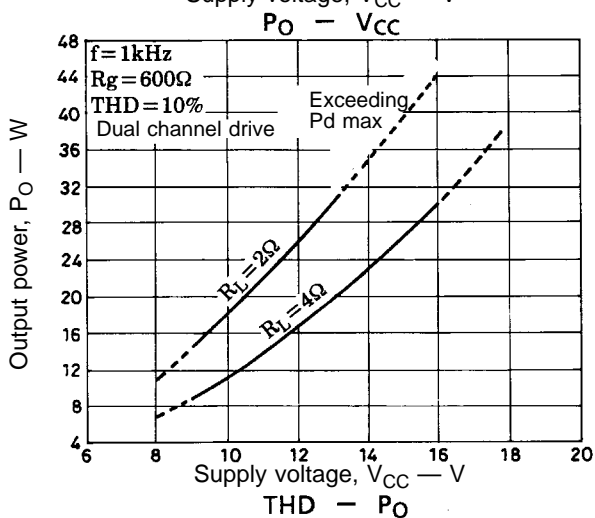
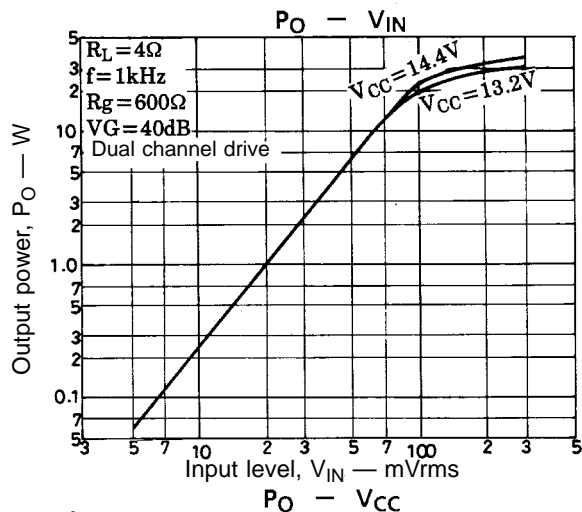
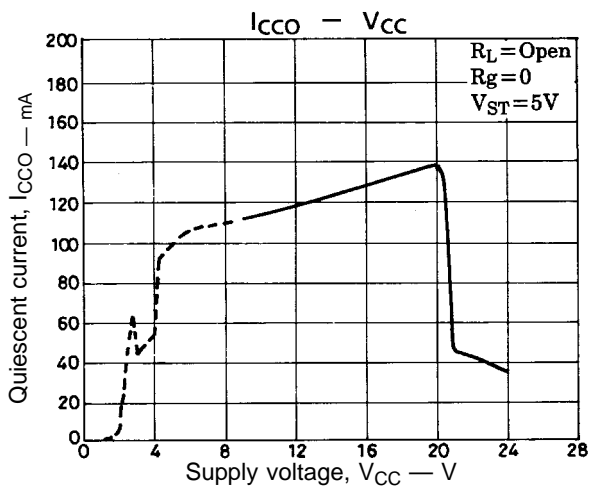

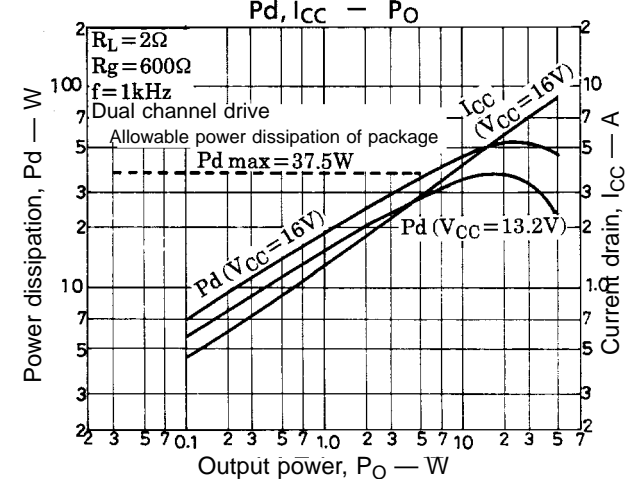
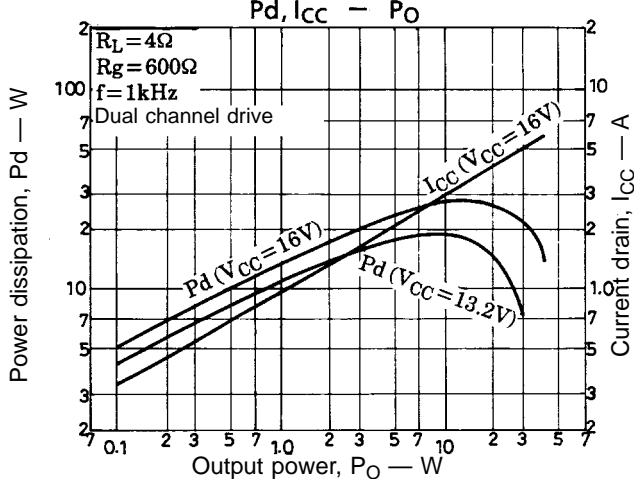
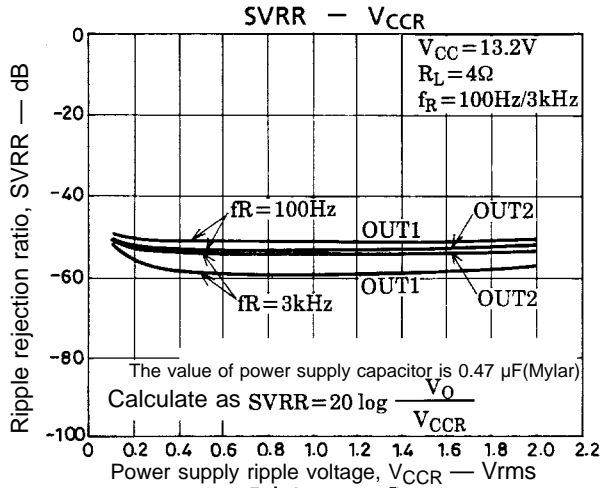
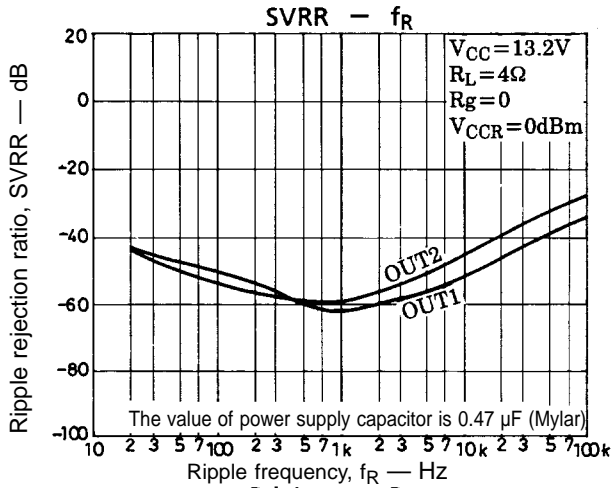
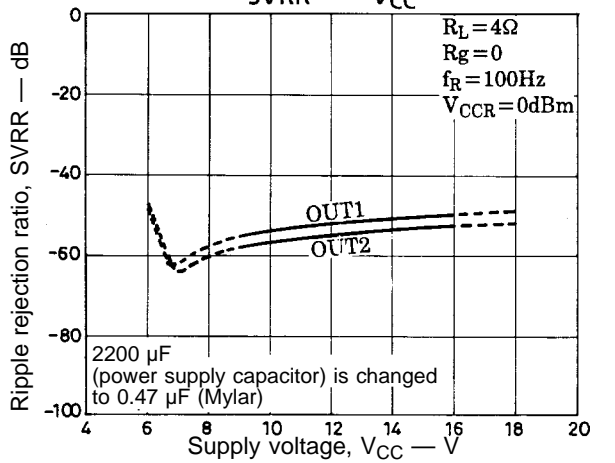
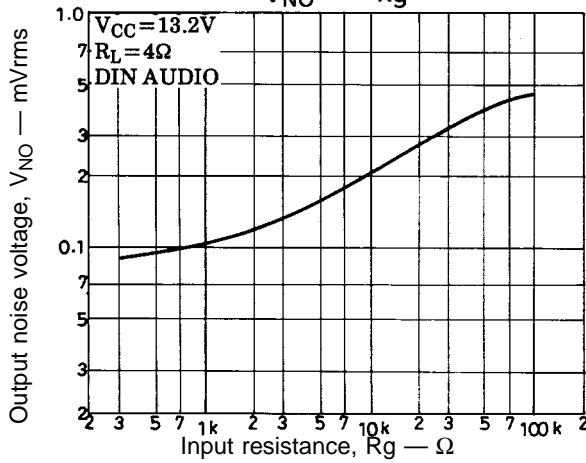
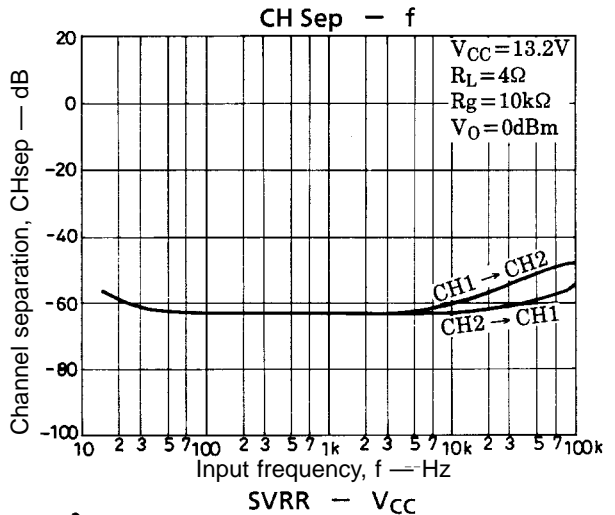
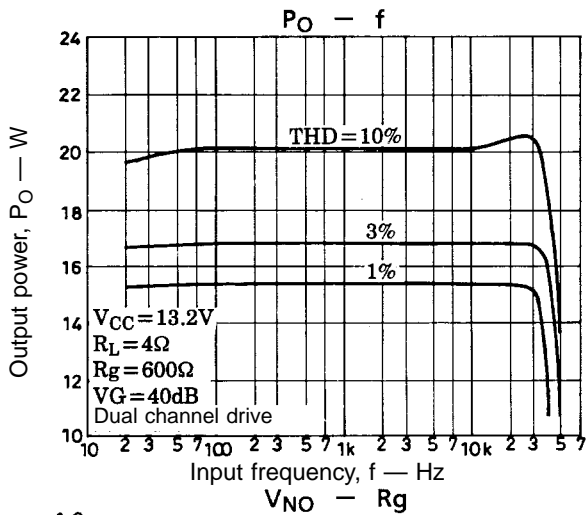

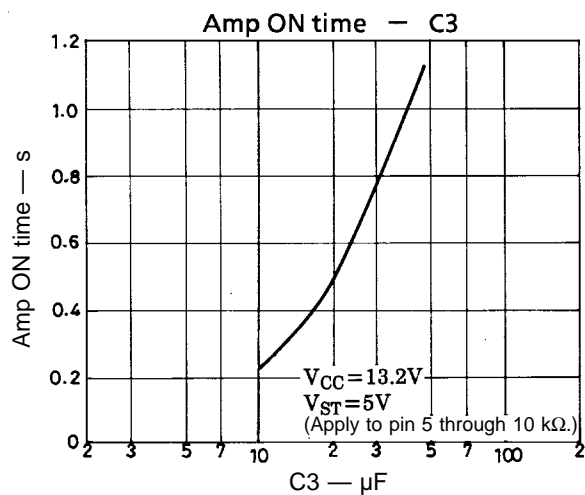
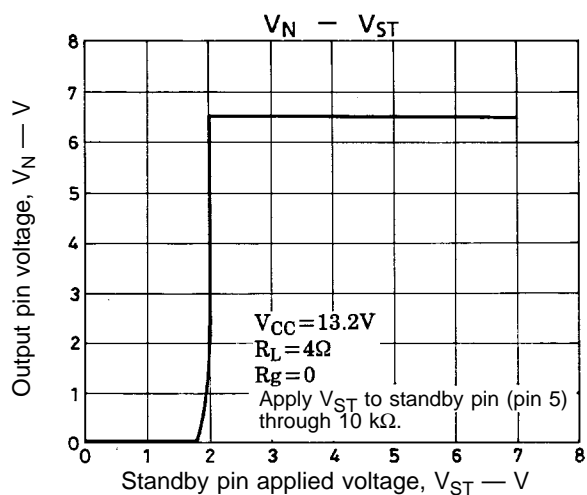
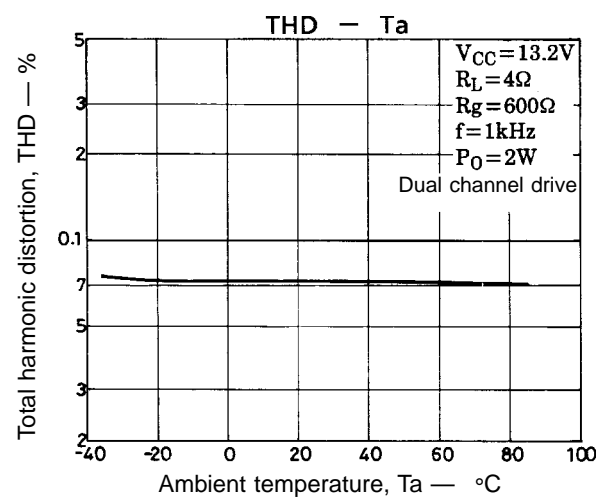
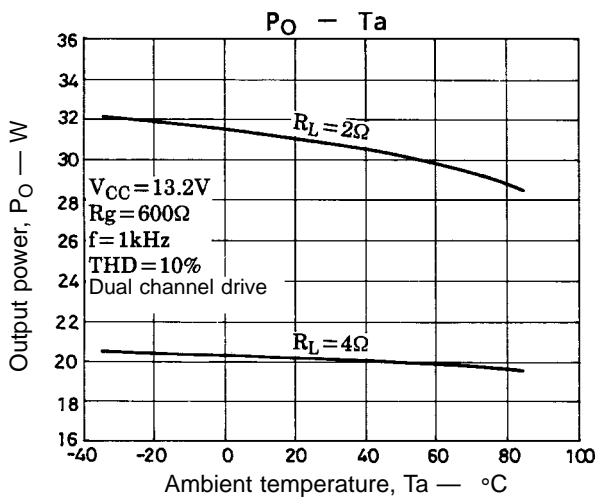
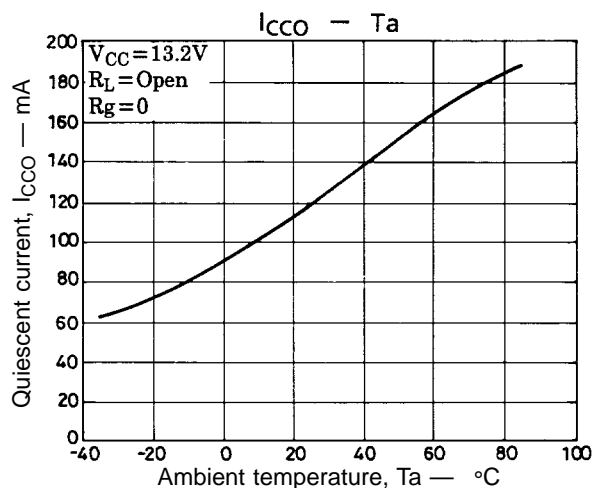
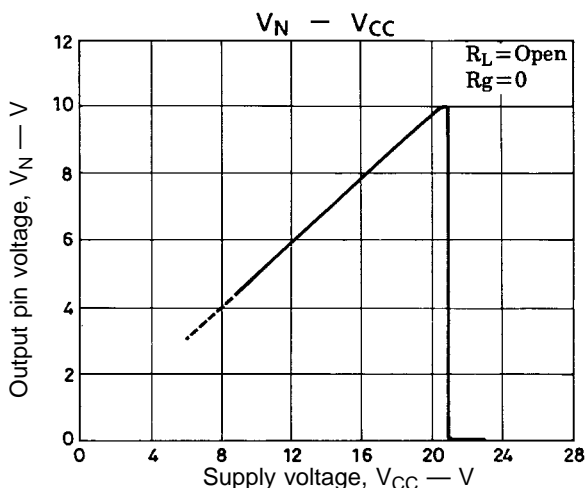



- Specifications of any and all SANYO products described or contained herein stipulate the performance, characteristics, and functions of the described products in the independent state, and are not guarantees of the performance, characteristics, and functions of the described products as mounted in the customer's products or equipment. To verify symptoms and states that cannot be evaluated in an independent device, the customer should always evaluate and test devices mounted in the customer's products or equipment.
- SANYO Electric Co., Ltd. strives to supply high-quality high-reliability products. However, any and all semiconductor products fail with some probability. It is possible that these probabilistic failures could give rise to accidents or events that could endanger human lives, that could give rise to smoke or fire, or that could cause damage to other property. When designing equipment, adopt safety measures so that these kinds of accidents or events cannot occur. Such measures include but are not limited to protective circuits and error prevention circuits for safe design, redundant design, and structural design.
- In the event that any or all SANYO products(including technical data, services) described or contained herein are controlled under any of applicable local export control laws and regulations, such products must not be exported without obtaining the export license from the authorities concerned in accordance with the above law.
- No part of this publication may be reproduced or transmitted in any form or by any means, electronic or mechanical, including photocopying and recording, or any information storage or retrieval system, or otherwise, without the prior written permission of SANYO Electric Co., Ltd.
- Any and all information described or contained herein are subject to change without notice due to product/technology improvement, etc. When designing equipment, refer to the "Delivery Specification" for the SANYO product that you intend to use.
- Information (including circuit diagrams and circuit parameters) herein is for example only ; it is not guaranteed for volume production. SANYO believes information herein is accurate and reliable, but no guarantees are made or implied regarding its use or any infringements of intellectual property rights or other rights of third parties.

This catalog provides information as of September, 1996. Specifications and information herein are subject to change without notice.