

User Manual

iR-AI04-TR User Manual

This guide walks through important information about iR-Axxx-TR.

UM018014E_20210818

Table of Contents

1. Product Overview	1
2. Specifications	2
2.1 Module Specification	2
2.2 Temperature Specification	2
3. LED Indicators	4
3.1 LV LED	4
3.2 RUN LED	4
3.3 ERR LED	4
3.4 STA LED	4
4. Error Handling	5
5. Wiring	6
6. Features	7
6.1 Feature List	7
6.2 Configurable Mode	7
6.3 Disconnection Detection	8
6.4 User-Defined Temperature Table	8
6.5 Analog Input – Filter Frame Size	8
7. Registers	9
8. iR-ETN Coupler Address Mapping	14
9. iR-COP Coupler Address Mapping	16
10. Downloading User-Defined Temperature Table to a Module	18
Appendix : Creating User-defined Temperature Reference Tables	21

1. Product Overview

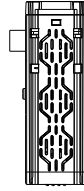

Top View

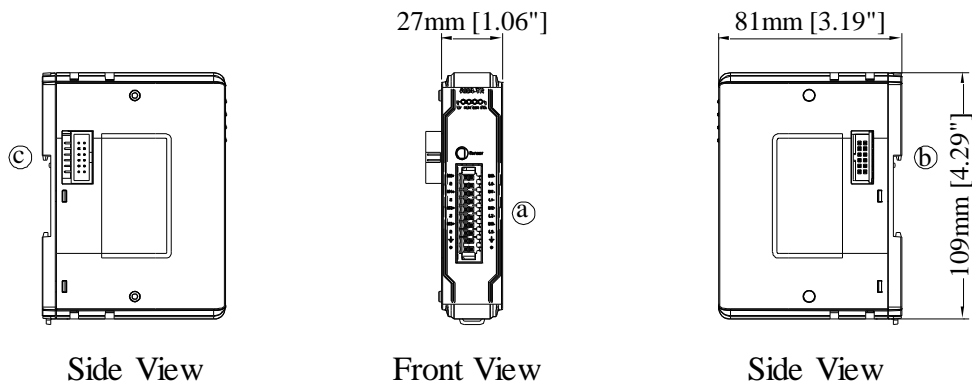

Side View

Front View

Side View

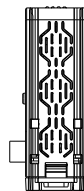

Bottom View

<i>a</i>	Terminal	<i>b.c</i>	Expansion Connector
----------	----------	------------	---------------------

2. Specifications

2.1 Module Specification

Module Name		iR-AI04-TR
Number of Input Channels		4
Current Consumption		65mA@5VDC
Analog Power Supply		24 VDC (20.4 VDC~28.8 VDC) (-15%~+20%)
Specification	PCB Coating	Yes
	Enclosure	Plastic
	Dimensions WxHxD	27 x 109 x 81 mm
	Weight	Approx. 0.12 kg
	Mount	35mm DIN rail mounting
Environment	Protection Structure	IP20
	Storage Temperature	-20° ~ 70°C (-4° ~ 158°F)
	Operating Temperature	0° ~ 55°C (32° ~ 131°F)
	Relative Humidity	10% ~ 90% (non-condensing)
	Vibration Resistance	Conforms to EN 60068-2-6 / EN 60068-2-27
Connection	Cross-section	AWG 28-16
Certification	EMC Immunity	Conforms to EN 55032: 2012+AC: 2013, Class A EN 61000-6-4: 2007+A1:2011 EN 55024: 2010+A1: 2015 EN 61000-6-2:2005

2.2 Temperature Specification

	Type	Standard	Material	Temperature Range
	Thermocouple	J	IEC 60584	Fe-CuNi
K		NiCr-Ni		-270 °C - 1370 °C
R		PtRh-Pt (Pt 13%)		-50 °C - 1760 °C
S		PtRh-Pt (Pt 10%)		-50 °C - 1760 °C
T		Cu-CuNi		-270 °C - 400 °C
E		NiCr-CuNi		-200 °C - 1000 °C
N		NiCrSi-NiSi		-270 °C - 1300 °C
B		PtRh-PtRh		200 °C - 1820 °C
C		W-Re(IEC 584)		0 °C - 2320 °C
L		DIN 43714	Fe-CuNi	0 °C - 900 °C
U			Cu-CuNi	-200 °C - 600 °C
TXK/XK(L)		P8.585-2001	Ni-9.5%Cr/Cu-44%Ni-13% Rh	-200 °C - -800 °C
TBP / BP(A)-1			W-5%Re/W-20%Re	0-2500
TBP / BP(A)-2			W-5%Re/W-20%Re	0-1800
TBP / BP(A)-3			W-5%Re/W-20%Re	0-1800
M			Cu-CuNi	-200-100
		Conversion Time	100ms/channel	
	Resolution	0.1°C/0.1°F		
	Accuracy	± [0.4 % + 3°C] Full Scale @ 25°C ± [0.6 % + 3°C] Full Scale @ 0° ~ 55°C		
RTD	Type	Pt100	Temperature Coefficient	Temperature Range
			α: 0.00385	-200°C ~850°C
			α: 0.00392	-200°C ~660°C
	jPt100		JIS C 1609	-200°C ~600°C
	PT200		α: 0.00385	-200°C ~850°C
	PT500		α: 0.00385	-200°C ~850°C
	Pt1000		α: 0.00385	-200°C ~850°C
			α: 0.00392	-200°C ~660°C
	LG-Ni1000		--	- 60~250°C
	Ni100		0.00617	-100~180°C
Ni120		0.00672	-80~260°C	
Ni1000		0.00617	-100~180°C	

	CU50	0.00428	-50°C ~150°C
	CU100	0.00428	-50°C ~150°C
	Conversion Time	200ms/channel	
	Resolution	0.1°C/0.1°F	
	Accuracy	± 0.2 % Full Scale@25°C ± 0.3 % Full Scale@0° ~ 55°C	
Voltage	Type	Conversion Time	Resolution
	±2V	100ms/channel	16bit
	±1V		
	±500mV		
	±250mV		
	±125mV		
	±62.5mV		
	±31.25mV		
Resistance	Type		
	0-5000Ω (0-30000)	200ms /channel	0.167Ω
	0-500Ω (0-30000)		0.0167Ω
Isolation	500 VDC : (Analog / Digital)		
Diagnose	Supply Voltage Wire break Overflow/underflow		

3. LED Indicators

3.1 L.V LED

State	Description
OFF	24V power normal
Blinking	Detect 24V power
ON	24V power error

3.2 RUN LED

State	Description
OFF	No Power
Blinking	iBus initiating
ON	iBus working

3.3 ERR LED

State	Description
OFF	No error
Blinking	Analog channel error
ON	Unable to perform conversion (Analog hardware error)

3.4 STA LED

State	Description
OFF	No error
Blinking	Conversion in progress

4. Error Handling

State	Description	Error Handling
L.V LED ON	24V power error	Check 24V power
L.V LED Blinking	Detect 24V power	Check 24V power
RUN LED is OFF	No Power	Check whether the coupler is properly powered, or if module malfunction occurs. Send the malfunction unit for repair.
ERR LED ON	Unable to perform conversion	Hardware error, send the unit for repair.
RUN LED Blinking	iBus initiating	Check whether the coupler is functioning, if not, send the unit for repair.
ERR LED Blinking	Channel conversion error	<p>Check the error code to find out whether the output value exceeds allowable range.</p> <p>Check the error code to find out whether the channel is set to a correct mode, or sensor disconnection occurs, or output value exceeds allowable range.</p>

5. Wiring

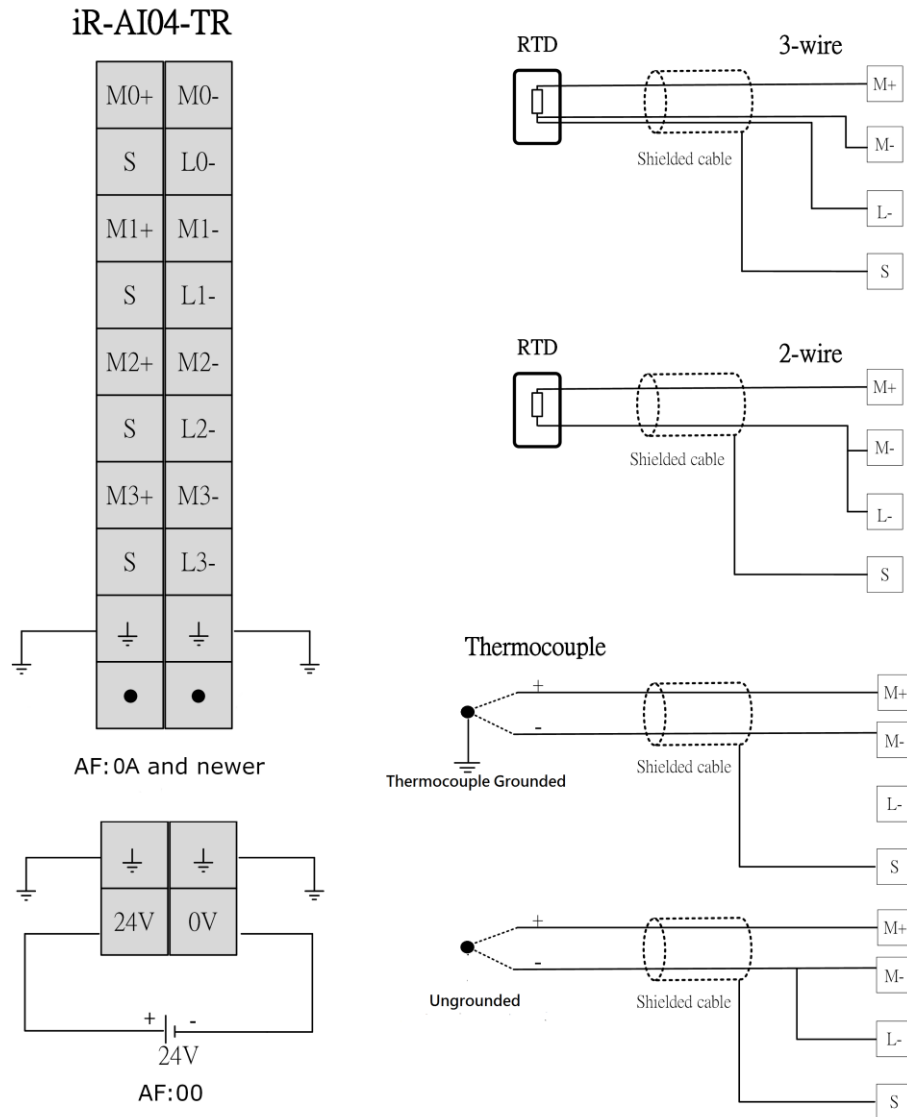

When using Thermocouple, please short the M0- and L0- pins.

AF:00 The terminals "24V" and "0V" are two contacts for users to wire as needed.

The supply voltage supplies the module with a voltage of 24V.

AF:0A The terminals "24V" and "0V" of AF:00 are changed to unused terminals. The internal system power supply delivers the voltage required by the module.

6. Features

6.1 Feature List

No.	Feature	Descriptions
1	Configurable mode (RTC / TC / Voltage / Resistance)	
3	Diagnose	RTD Thermocouple
5	User-Defined Temperature Table	
6	Digital Filter	

6.2 Configurable Mode

This module supports most of the thermocouple and RTC on the market. An input channel can be configured as Voltage or Resistance mode.

	Type	Standard	Material	Temperature Range	
	Thermocouple	J	IEC 60584	Fe-CuNi	-210 °C - 1200 °C
K		NiCr-Ni		-270 °C - 1370 °C	
R		PtRh-Pt (Pt 13%)		-50 °C - 1760 °C	
S		PtRh-Pt (Pt 10%)		-50 °C - 1760 °C	
T		Cu-CuNi		-270 °C - 400 °C	
E		NiCr-CuNi		-200 °C - 1000 °C	
N		NiCrSi-NiSi		-270 °C - 1300 °C	
B		PtRh-PtRh		200 °C - 1820 °C	
C		W-Re(IEC 584)		0 °C - 2320 °C	
L		DIN 43714	Fe-CuNi	0 °C - 900 °C	
U			Cu-CuNi	-200 °C - 600 °C	
TXK/XK(L)		P8.585-2001	Ni-9.5%Cr/Cu-44%Ni-13% Rh	-200 °C - -800 °C	
TBP / BP(A)-1			W-5%Re/W-20%Re	0-2500	
TBP / BP(A)-2			W-5%Re/W-20%Re	0-1800	
TBP / BP(A)-3			W-5%Re/W-20%Re	0-1800	
M			Cu-CuNi	-200-100	
		Conversion Time	100ms/channel		
		Resolution	0.1°C/0.1°F		
	Accuracy	± [0.4 % + 3°C] Full Scale @ 25°C ± [0.6 % + 3°C] Full Scale @ 0° ~ 55°C			
RTD	Pt100		α: 0.00385	-200°C ~850°C	
			α: 0.00392	-200°C ~660°C	
	jPt100		JIS C 1609	-200°C ~600°C	
	PT200		α: 0.00385	-200°C ~850°C	
	PT500		α: 0.00385	-200°C ~850°C	
	Pt1000		α: 0.00385	-200°C ~850°C	
			α: 0.00392	-200°C ~660°C	
	LG-Ni1000		--	- 60~250°C	
	Ni100		0.00617	-100~180°C	
	Ni120		0.00672	-80~260°C	
	Ni1000		0.00617	-100~180°C	
	CU50		0.00428	-50°C ~150°C	
	CU100		0.00428	-50°C ~150°C	
		Conversion Time	200ms/channel		
		Resolution	0.1°C/0.1°F		
	Accuracy	± 0.2 % Full Scale@25°C ± 0.3 % Full Scale@0° ~ 55°C			
Voltage	Type	Conversion Time	Resolution		
	±2V	100ms/channel	16bit		

	±1V		
	±500mV		
	±250mV		
	±125mV		
	±62.5mV		
	±31.25mV		
Resistance	Type	Conversion Time	Resolution
	0-5000Ω (0-30000)	200ms /channel	0.167 Ω
	0-500Ω (0-30000)		0.0167 Ω
Isolation	500 VDC : (Analog / Digital)		
Diagnose	Supply Voltage Wire break Overflow/underflow		

6.3 Disconnection Detection

A channel alarm will be generated when input sensor disconnection is detected.

6.4 User-Defined Temperature Table

Apart from the temperature tables of common Thermocouple and RTD, users can defined their own temperature reference tables so that even when the sensor type is not in the built-in list, the user can still define corresponding temperature table and use the temperature module to collect temperature values from the sensors.

Allowable ranges are: 0-500 ohm, 0-5k ohm.

6.5 Analog Input – Filter Frame Size

The Filter Frame Size can stabilize the signal by averaging sampled values, in order to achieve better control.

7. Registers

No.	Description	Default	Read/Write
0	Channel 0 Mode	1	Read/Write
1	Channel 1 Mode	1	Read/Write
2	Channel 2 Mode	1	Read/Write
3	Channel 3 Mode	1	Read/Write
4	Channel 0 Scale Range Upper Limit	32000	Read/Write
5	Channel 1 Scale Range Upper Limit	32000	Read/Write
6	Channel 2 Scale Range Upper Limit	32000	Read/Write
7	Channel 3 Scale Range Upper Limit	32000	Read/Write
8	Channel 0 Scale Range Lower Limit	-32000	Read/Write
9	Channel 1 Scale Range Lower Limit	-32000	Read/Write
10	Channel 2 Scale Range Lower Limit	-32000	Read/Write
11	Channel 3 Scale Range Lower Limit	-32000	Read/Write
12	Channel 0 Filter Frame Size	5	Read/Write
13	Channel 1 Filter Frame Size	5	Read/Write
14	Channel 2 Filter Frame Size	5	Read/Write
15	Channel 3 Filter Frame Size	5	Read/Write
16	Error Code	0	Read
17	Command	0	Read/Write
18	Channel Detection	FFh	Read/Write
19	Celsius / Fahrenheit Setting	0	Read/Write
20	Channel 0 Temperature Offset	0	Read/Write
21	Channel 1 Temperature Offset	0	Read/Write
22	Channel 2 Temperature Offset	0	Read/Write
23	Channel 3 Temperature Offset	0	Read/Write
24	Channel 0 Maximum Value	0	Read
25	Channel 1 Maximum Value	0	Read
26	Channel 2 Maximum Value	0	Read
27	Channel 3 Maximum Value	0	Read
28	Channel 0 Minimum Value	0	Read
29	Channel 1 Minimum Value	0	Read
30	Channel 2 Minimum Value	0	Read
31	Channel 3 Minimum Value	0	Read

* Scale range setting is only available for Voltage mode.

* Temperature offset setting is only available for temperature mode.

- Mode Setting

Value	Description	
0	Close	
1	Thermocouple	J
2		K
3		R
4		S
5		T
6		E
7		N
8		B
9		C
10		L
11		U
12		TXK/XK(L)
13		TBP / BP(A)-1
14		TBP / BP(A)-2
15		TBP / BP(A)-3
16		M
17	RTD	Pt100 -385
18		Pt100 -392
19		Pt1000-385
20		Pt1000-392
21		LG-Ni1000
22		Ni100
23		Ni1000
24		CU50
25		CU100
26		User-defined Temperature Table
27	Resistance	0-500 Ω
28		0-5K Ω
29		Reserved
30		Reserved
31		Reserved
32		Reserved

33		Reserved
34		Reserved
35	Voltage	$\pm 2V$
36		$\pm 1V$
37		$\pm 500mV$
38		$\pm 250mV$
39		$\pm 125mV$
40		$\pm 62.5mV$
41		$\pm 31.25mV$
42	RTD	JPt100
43	RTD	Pt200
44	RTD	Pt500
45	x	Reserved
46	RTD	Ni120

- Voltage Mode connection at inputs:

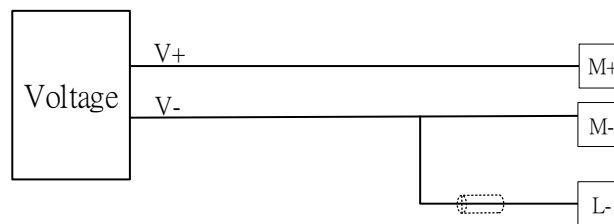

(L- connected to V- contact with low-resistance)

- Displaying digital value:
 - The temperature resolution for thermocouple and RTD is 0.1 degree. That is, 101.5 degrees = 1015 digital value.
 - In Resistance mode, the range of digital value is 0~30000. For example, in 500 ohm mode, when the sensor detects 250 ohm, the digital value obtained is 15000. When the sensor detects 100 ohm, the digital value obtained is 6000.
 - In Voltage mode, the digital value is determined by the upper and lower limit of the voltage range. In $\pm 500mV$ mode, the upper limit of the scale range is 32000 by default, and the lower limit is -32000 by default. When the sensor detects 500mv, the digital value obtained is 32000, and when the sensor detects -500mv, the digital value obtained is -32000. (Please note that scale range setting is only applicable for Voltage mode.)

- Scale Range Setting

This setting is only available for voltage mode. Please note that setting the upper limit and lower limit to the same value will make the system use the default value.

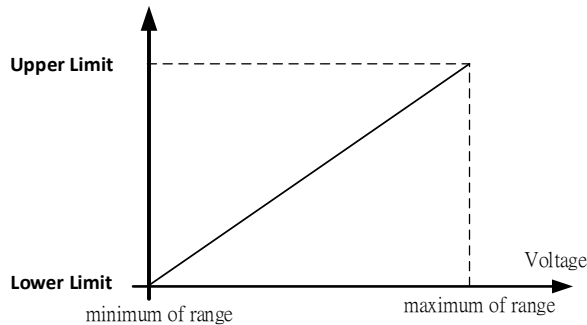

Setting	Description	Default
Upper Limit	Allowable range: -32768~32767	32000
Lower Limit	Allowable range: -32768~32767	-32000

- Analog Input maximum / minimum value

This setting keeps on recording the maximum and minimum digital value. The record can be cleared by giving a command (restart recording).

Setting	Description	Default
Input Max./Min. Value	Allowable range: -32768~32767	0

- Error Code

Error Code	Description
0	Power error
1	Hardware error
2	Device isn't calibrated
3	Reserved
4	Conversion cannot be performed.
5	cold junction compensation error
6	Reserved
7	Reserved
8	Input Channel 0 error
9	Input Channel 1 error
10	Input Channel 2 error
11	Input Channel 3 error

12	Reserved
13	Reserved
14	Reserved
15	Reserved

- Command

Value	Description
0x0001	Restore factory default
0x0002	Reset the max./min. value of analog input channel 0
0x0003	Reset the max./min. value of analog input channel 1
0x0004	Reset the max./min. value of analog input channel 2
0x0005	Reset the max./min. value of analog input channel 3
0x0006	Reset the max./min. value of analog input channel 0-3

- Celsius / Fahrenheit Setting

Value	Description
0	Celsius
1	Fahrenheit

- Channel Detection

Bit	Description	Value	
		1	0
0	Analog Input Channel 0 Detection	Enable	Disable
1	Analog Input Channel 1 Detection	Enable	Disable
2	Analog Input Channel 2 Detection	Enable	Disable
3	Analog Input Channel 3 Detection	Enable	Disable
4-15	Reserved		

8. iR-ETN Coupler Address Mapping

Module No.	Module Registers	iR-ETN Modbus Address
1 st	500	20000-20499
2 nd	500	20500-20999
3 rd	500	21000-21499
4 th	500	21500-21999
.....
16 th	500	27500-27999

● Example:

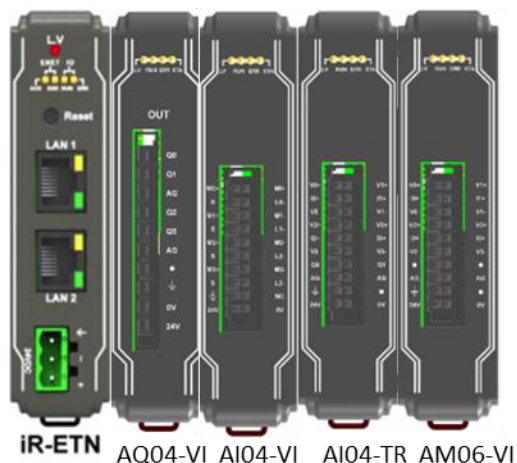

Module No.	Module Name
0	iR-ETN
1	iR-AQ04-VI
2	iR-AI04-VI
3	iR-AI04-TR
4	iR-AM06-VI

Module	Module Register	iR-ETN Modbus Address
iR-AQ04-VI	0# Channel 0 Output Mode	20000
	1# Channel 1 Output Mode	20001
	2# Channel 2 Output Mode	20002
	3# Channel 3 Output Mode	20003

	16# Error Code	20016

iR-AI04-VI	20# Channel 0 Input Mode	20520
	21# Channel 1 Input Mode	20521
	22# Channel 2 Input Mode	20522
	23# Channel 3 Input Mode	20523

iR-AI04-TR	0# Channel 0 Input Mode	21500

	1# Channel 1 Input Mode	21501
	2# Channel 2 Input Mode	21502
	3# Channel 3 Input Mode	21503

iR-AM06-VI	0# Channel 0 Output Mode	21500
	1# Channel 1 Output Mode	21501

	20# Channel 0 Input Mode	21520
	21# Channel 1 Input Mode	21521
	22# Channel 2 Input Mode	21522
	23# Channel 3 Input Mode	21523

Module	Module Analog Channel		iR-ETN Modbus Address
iR-AI04-VI	Analog Input	Channel 0 Digital Value	0
		Channel 1 Digital Value	1
		Channel 2 Digital Value	2
		Channel 3 Digital Value	3
iR-AI04-TR		Channel 0 Digital Value	4
		Channel 1 Digital Value	5
		Channel 2 Digital Value	6
		Channel 3 Digital Value	7
iR-AM06-VI		Channel 0 Digital Value	8
		Channel 1 Digital Value	9
		Channel 2 Digital Value	10
		Channel 3 Digital Value	11
iR-AQ04-VI	Analog Output	Channel 0 Digital Value	256
		Channel 1 Digital Value	257
		Channel 2 Digital Value	258
		Channel 3 Digital Value	259
iR-AM06-VI		Channel 0 Digital Value	260
		Channel 1 Digital Value	261

*Modbus Read Function Codes: 03h, 04h, 17h; Write Function Code: 06h, 10h, 17h

9. iR-COP Coupler Address Mapping

Module No.	Module Registers	Object Dictionary	
		Index	Sub-Index
1 st	127	3000h	01h-80h
2 nd	127	3001h	01h-80h
3 rd	127	3002h	01h-80h
4 th	127	3003h	01h-80h
.....	01h-80h
16 th	127	300Fh	01h-80h

● Example:

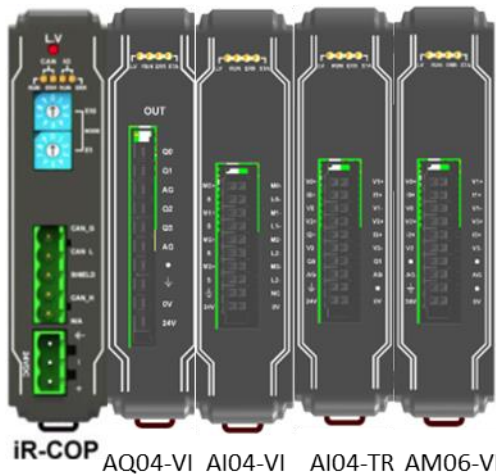

Module No.	Module Name
0	iR-COP
1	iR-AQ04-VI
2	iR-AI04-VI
3	iR-AI04-TR
4	iR-AM06-VI

Module	Module Register	Index	Sub-Index
iR-AQ04-VI	0# Channel 0 Output Mode	3000h	01h
	1# Channel 1 Output Mode	3000h	02h
	2# Channel 2 Output Mode	3000h	03h
	3# Channel 3 Output Mode	3000h	04h

	16# Error Code	3000h	10h

iR-AI04-VI	20# Channel 0 Input Mode	3001h	15h
	21# Channel 1 Input Mode	3001h	16h
	22# Channel 2 Input Mode	3001h	17h
	23# Channel 3 Input Mode	3001h	18h

iR-AI04-TR	0# Channel 0 Input Mode	3002h	01h
	1# Channel 1 Input Mode	3002h	02h
	2# Channel 2 Input Mode	3002h	03h
	3# Channel 3 Input Mode	3002h	04h

iR-AM06-VI	0# Channel 0 Output Mode	3003h	01h
	1# Channel 1 Output Mode	3003h	02h

	20# Channel 0 Input Mode	3003h	15h
	21# Channel 1 Input Mode	3003h	16h
	22# Channel 2 Input Mode	3003h	17h
	23# Channel 3 Input Mode	3003h	18h

10. Downloading User-Defined Temperature Table to a Module

Step 1. Connect iR-AI04-TR to iR-ETN, and then launch EasyRemotIO software to find this module.

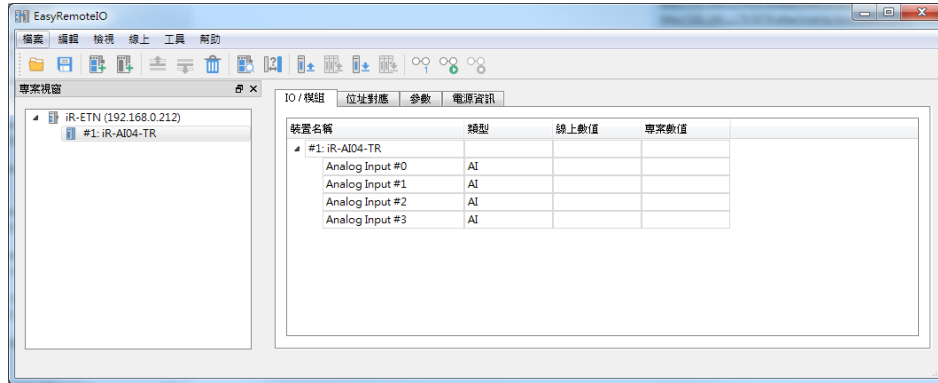

Step 2. Select iR-AI04-TR, and then select [Online] » [User Defined Temp. Table].

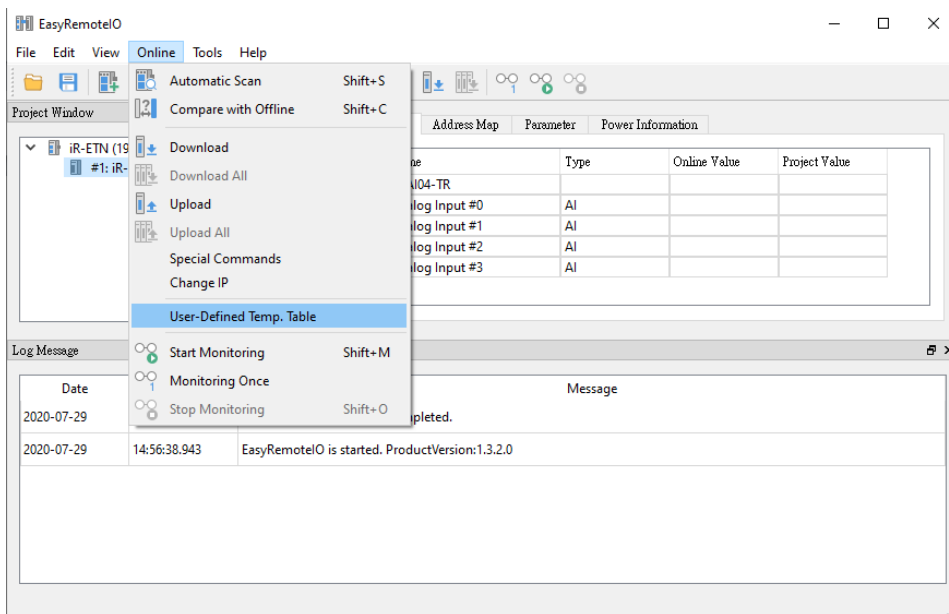

Step 3. In Temperature Dialog, you may load the pre-defined temperature tables into your device, or import the temperature tables you defined and saved into a CSV file. (For more information on defining your own temperature tables, please see the appendix in this user manual.)

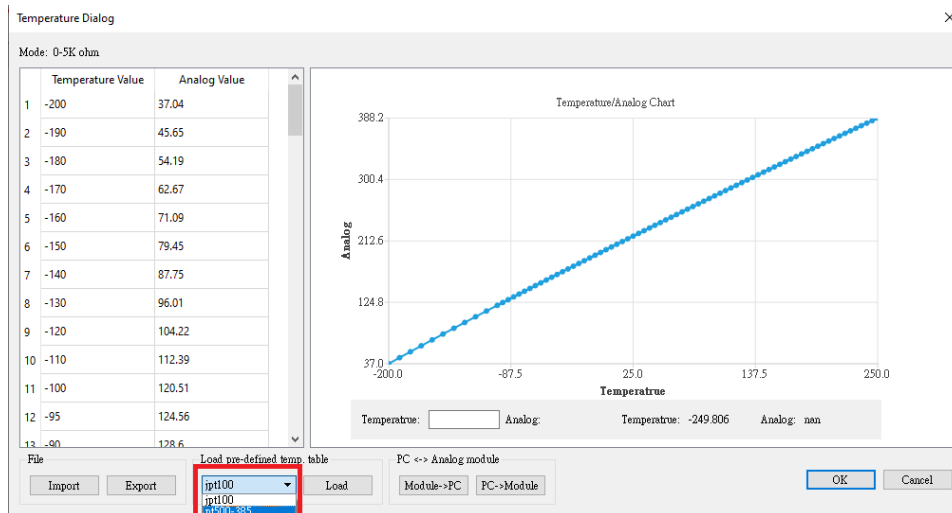

Step 4. Click [PC-Module] to download the user-defined temperature reference table to the module.

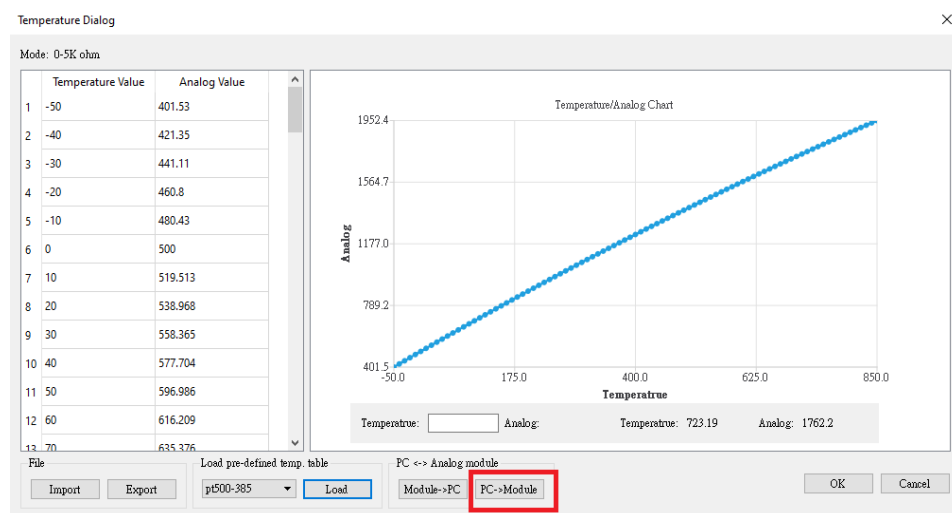

✳️Select User Defined for Input Modes.

Channel Name	Online Value	Project Value
▲ #1: iR-AI04_TR		
Product code		
Firmware revision		
Hardware revision		
Power consumption		
Point Of Digital input		
Point Of Digital output		
Number Of Analog input		
Number Of Analog output		
Input Mode #0		User Defined
Input Mode #1		User Defined
Input Mode #2		User Defined
Input Mode #3		User Defined
Input Scale Range Max #0		32000
Input Scale Range Max #1		32000
Input Scale Range Max #2		32000
Input Scale Range Max #3		32000
Input Scale Range Min #0		-32000
Input Scale Range Min #1		-32000

Appendix : Creating User-defined Temperature Reference Tables

Exporting an existing temperature table and then changing the content to make a user-defined table is recommended.

- Step 1.** Open a CSV file, enter the temperature reference one by one in Temperature column, and then enter the corresponding resistance points in Analog column. Please keep the same interval between temperatures.

	A	B	C
1	Temperatu	Analog	
2	-200	17.1362	
3	-190	21.4619	
4	-180	25.8016	
5	-170	30.1247	
6	-160	34.4186	
7	-150	38.68	
8	-140	42.909	
9	-130	47.1106	
10	-120	51.2854	
11	-110	55.4368	
12	-100	59.5673	
13	-90	63.6789	
14	-80	67.7729	
15	-70	71.8506	
16	-60	75.9129	
17	-50	79.9606	
18	-40	83.9944	
19	-30	88.0148	

- Step 2.** For resistance range between 0-500 ohm, enter 0 for Mode. For resistance range between 0-5000 ohm, enter 1 for Mode. Please note that this setting is not applicable for resistance range over 5000 ohm.

82	600	317.2773	
83			
84	Mode	0	
85			
86	0-500 ohm	0	
87	0-5K ohm	1	