

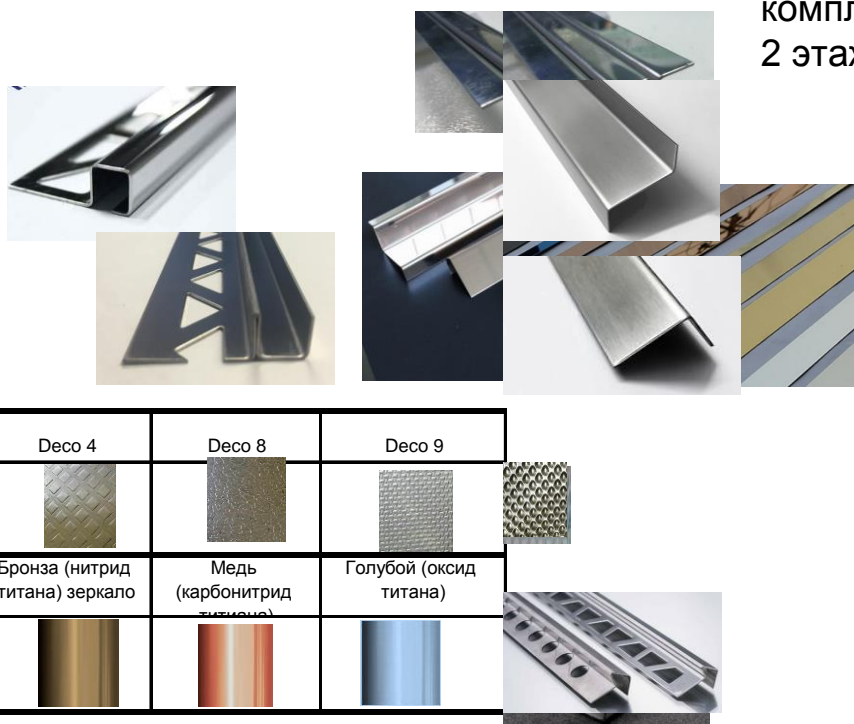

Euroline Comp.
 +7 (921) 997 47 18
 СПб., ул. Типанова, 27/39. Торговый
 комплекс "Космос" Галерея Мебели,
 2 этаж. aleuroline@mail.ru

Материал / поверхность / цвет					
AISI 430 зеркальный и шлифованный	Зеркало/полипрванная	Шлифованная			
AISI 304 зеркальный и шлифованный	Зеркало/полипрванная	Шлифованная			
AISI 304 Декорированный	Deco 1	Deco 2	Deco 4	Deco 8	Deco 9
AISI 304 Нитрид Титан	Золото (нитрид титана) зеркало	Золото (нитрид титана) шиф	Бронза (нитрид титана) зеркало	Медь (карбонитрид титана)	Голубой (оксид титана)



Изготовление профилей из нержавеющей стали на заказ

Помимо большого ассортимента уже готовых изделий, мы так же принимаем заказы на изготовление профиля из нержавеющей листовой стали или титана по вашему чертежу. Для этого нужно иметь заказ не менее 50 погонных метров. Достаточно начертить профиль на листке бумаги, расписать все размеры сторон, градусы углов, радиусы загибов и т.д., и выслать ваш заказ на почту. Чем подробнее будет ваш заказ

на изготовление нержавеющей стали, тем точнее мы сможем изготовить изделие с помощью наших технологий на

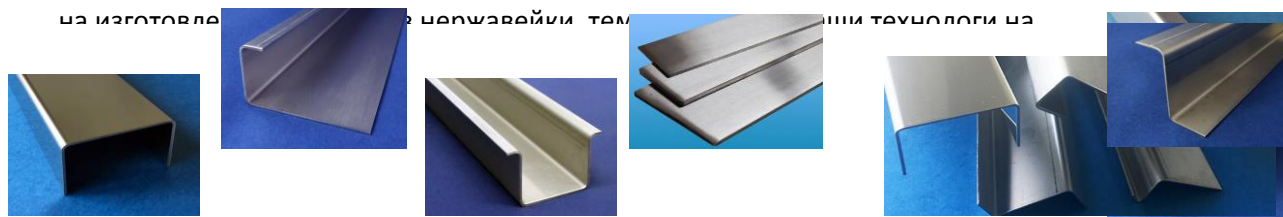

Цена указана в рублях за единицу изделия. Длина может быть 2 / 2,5 / 2,7 / 3.0 метра



--	--	--

ВИД	РАЗМЕР, мм	АРТИКУЛ
-----	------------	---------

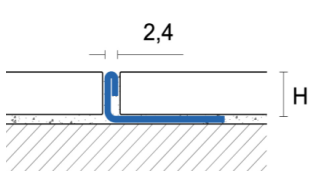
Г - образный профиль

 	4,5	TR 45
	6	TR 60
	8	TR 80
	10	TR 100
	12,5	TR 125
	15	TR 150
	17,5	TR 175
	22	TR 220
	25	TR 250
	30	TR 300

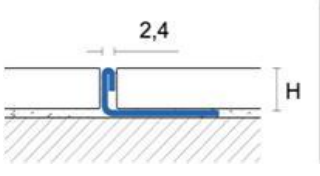
Гибкий Г - образный профиль

  	4,5	TRD 45
	6	TRD 60
	8	TRD 80
	10	TRD 100
	12,5	TRD 125
	15	TRD 150
	17,5	TRD 175
	25	TRD 250

Г - образный профиль с полочкой 5 мм

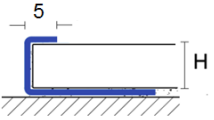
 	4,5	UN 45
	6	UN 60
	8	UN 80
	10	UN 100
	12,5	UN 125

С - образный профиль

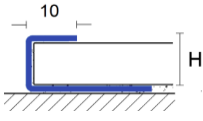

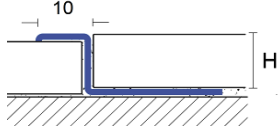

 	6	LU 60
	8	LU 80
	10	LU 100
	12,5	LU 125
	15	LU 150
	22	LU 220

ВИД	РАЗМЕР, мм	АРТИКУЛ
-----	------------	---------

Z - образный профиль

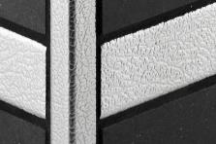
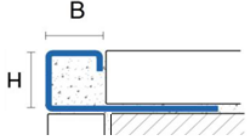
 	10	EP 100
	12,5	EP 125

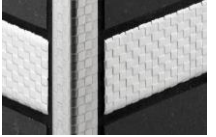
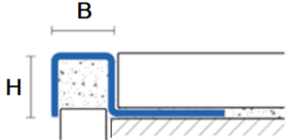
Квадратный профиль

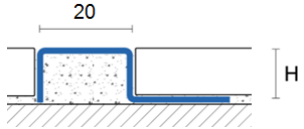
  	8x8	LUP 80
	10x10	LUP 100
	12,5x12,5	LUP 125
	15x15	LUP 15
  	8x8	CU 80
	10x10	CU 100
	12,5x12,5	CU 125
 	20x10	CU 2010
	20x12.5	CU 2012

Омега профиль

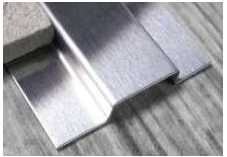
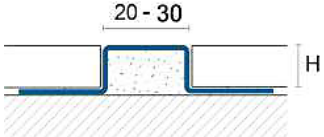

 	20x10	PO 2010
	30x12.5	PO 30 12

ВИД	РАЗМЕР, мм	АРТИКУЛ
-----	------------	---------

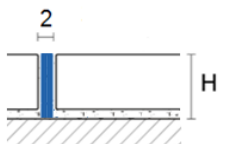
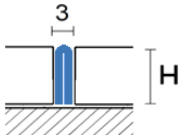

Разделительные стыковочные профили

		15x2	PP 150
		20x2	PP 200
		30x2	PP 300
		40x2	PP 400
		12x3	PT 120
		15x3	PT 150
		20x3	PT 200

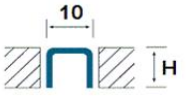
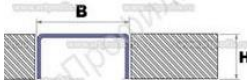
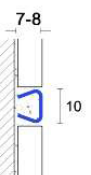
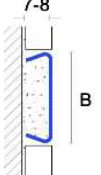
П - образный профиль

 		8x8	PU 8
		10x10	PU 10
		10x15x10	PU 1510
		10x20x10	PU 2010
		10	LI 10
		15	LI 15
		20	LI 20
		25	LI 25

Т - образный профиль под базу

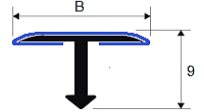
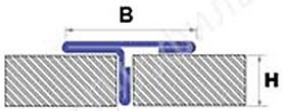

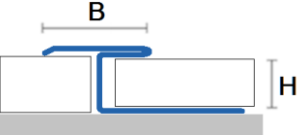

 		15x8	SPA 15
		22x8	SPA 22
		27x8	SPA 27
		15x9	SP 15
		20x9	SP 20
		26x9	SP 26
		30x9	SP 30

Т - образный профиль



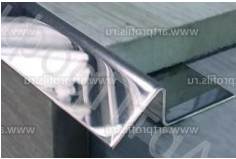
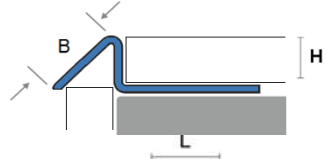

		16x11	MP 1611
		25x11	MP 2511
		30x13	MP 3013

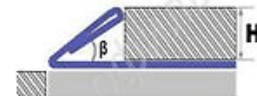
ВИД	РАЗМЕР, мм	АРТИКУЛ
-----	------------	---------

Краевой профиль для полов, несопадающих по высоте на 7-17мм

		10	ZR 100
		12,5	ZR 125
		10	ZRM 100
		10	ZRR 100
		10	DS 10

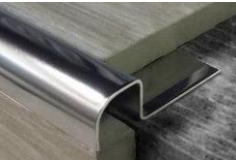
Внешний закругленный профиль

		6	RJ 609
		8	RJ 809
		10	RJ 1009
		12,5	RJ 1259
		10	RJZ 100
		12,5	RJZ 125
		15	RJZ 150
		10	RD 100

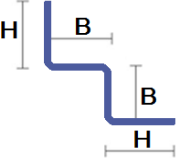

	10x7x7x10	RN 107

ВИД	РАЗМЕР, мм	АРТИКУЛ
-----	------------	---------

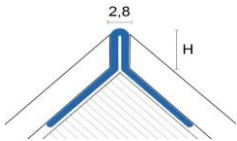
Минимальный угловой профиль

 	8	RJF 80
	10	RJF 100
	12,5	RJF 125
	8	TRV 80
	10	TRV 100
	12,5	TRV 125

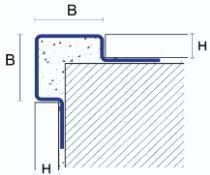
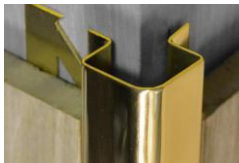
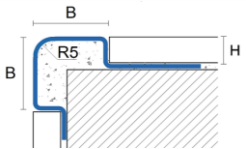
Антивандальный профиль

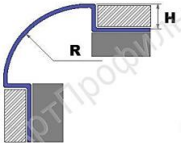
     	16x8x0,8	RE 1508
	20x10x0,8	RE 2010
	25x10x0,8	RE 2510
	30x10x0,8	RE 3010
	30x12,5x0,8	RE 3012
	30x15x0,8	RE 3015
	25x10	REP 2510
	30x12,5	REP 3012
	25x10x1	REP 3012/1
	30x12,5x1	REP 3012/1
	10	RAP 20/10
	12,5	RAP 20/12

Внутренний угол под плитку

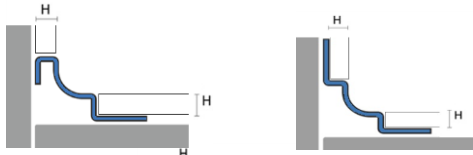
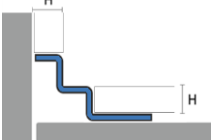
  	10	RI 100
	12,5	RI 125
	10	RQ 100
	12,5	RQ 125

ВИД	РАЗМЕР, мм	АРТИКУЛ
-----	------------	---------

Внутренний угол под плитку

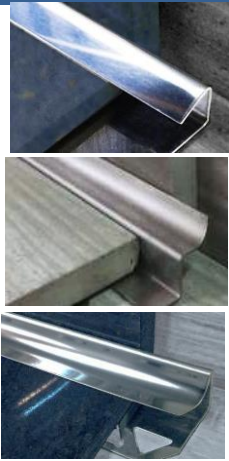
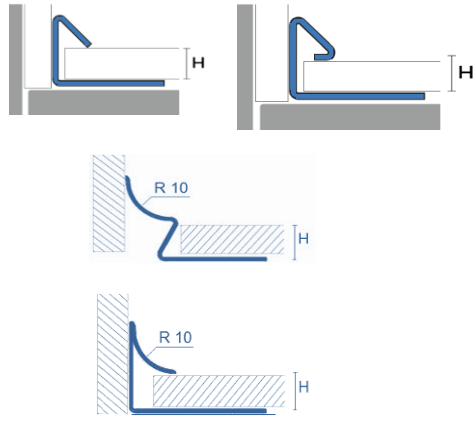
		10	IJT 100
		12,5	IJT 125
		10	IJC 100
		12,5	IJC 125
		10	IJV 100
		12,5	IJV 125

Окантовочные профили для ступеней

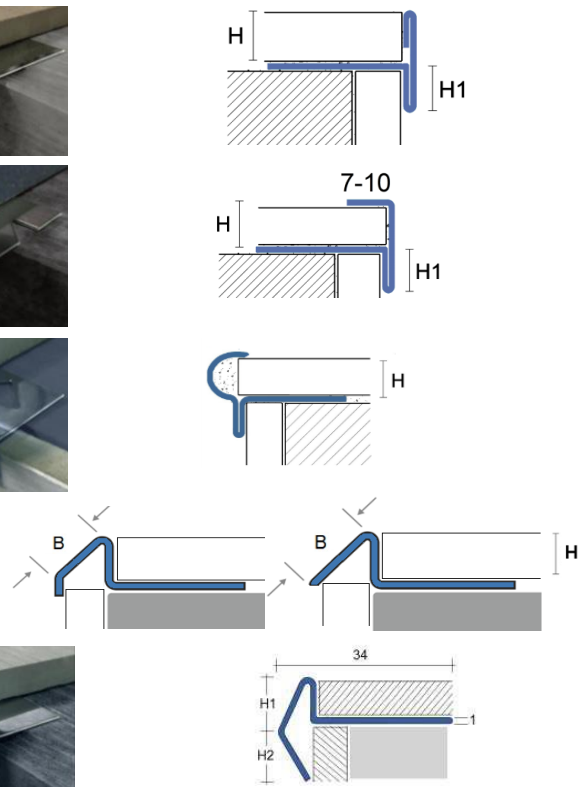
		10x12,5	SR 10/12
		12,5x15	SR 12/15
		10	SK 100A
		12,5	SK 125
		15	SK 150
		10	FL 100
		12,5	FL 125
		10	ZR 100
		12,5	ZR 125
		10	FLM 100
		12,5	FLM 125

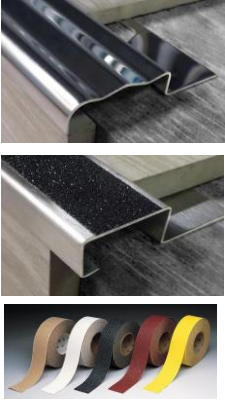
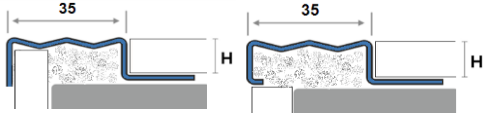
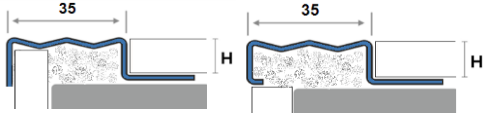
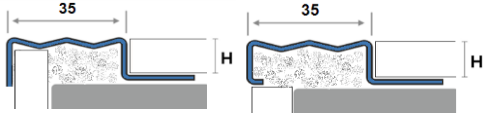
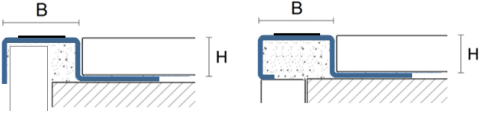
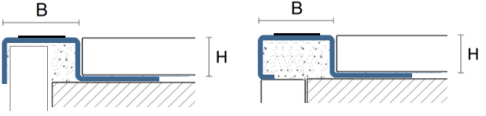
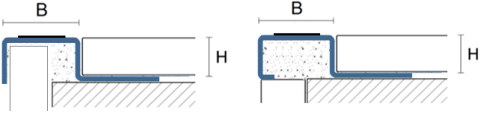
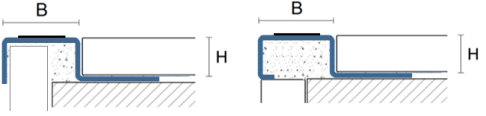
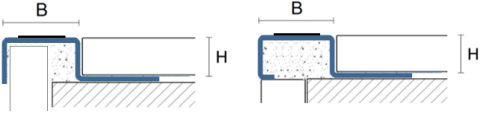
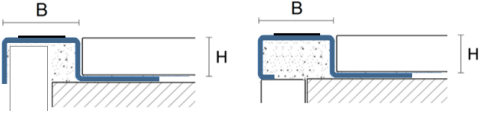
ВИД	РАЗМЕР, мм	АРТИКУЛ	
		10x0,8	FO 100/0,8
		10x1	FO 100
		12,5x1	FO 125
		25x10x1	FI 2510
		25x12,5x1	FI 2512
		33x10x1	FI 3310
		33x12,5x1	FI 3312
	Карборундовая лента		
		19	SW 19
		25	SW 25

Угловой профиль для защиты краев ступеней против скольжения. Установка на готовую поверхность.

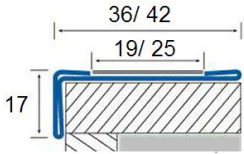
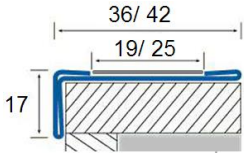
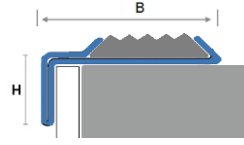
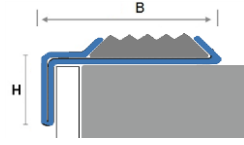
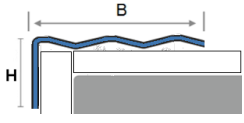
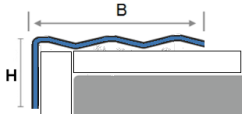
		36x17x1	SA 35x17
		42x17x1	SA 41x17
	Карборундовая лента		
		19	SW 19
		25	SW 25
		45x25	SM 45x25
	Резиновая вставка		
	40x22x1	PLN 40x20	

Уголок разносторонний

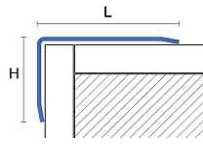
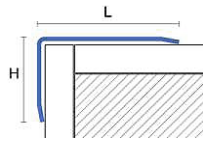
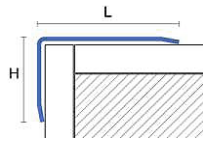
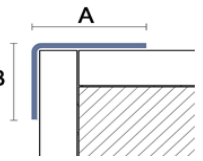
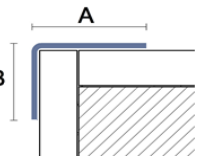
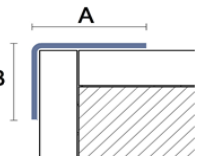
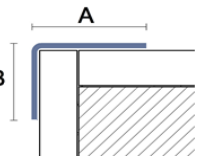
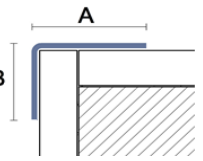
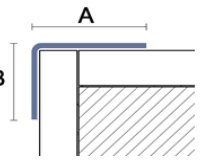
		30x15x0.8	COL 30x15/0.8
		40x20x0.8	COL 40x20/0.8
		60x30x1	COL 60x30/1
		15x8x0.8	PL 15x8/0,8
		20x10x0.8	PL 20x10/0,8
		30x15x0.8	PL 30x15/0,8
		40x20x1	PL 40x20/1
		70x30x1	PL 70x30/1
		80x40x1,2	PL 80x40/1,2

ВИД	РАЗМЕР, мм	АРТИКУЛ
-----	------------	---------

Уголок отделочный наружный

	15x15x0,8	CO 15/0.8
	20x20x0.8	CO 20/0.8
	25x25x0.8	CO 25/0.8
	30x30x0.8	CO 30/0.8
	40x40x0.8	CO 40/0.8
	50x50x0.8	CO 50/0.8
	50x50x1	CO 50/1
	60x60x1	CO 60/1
	70x70x1	CO 70/1
	100x100x1	CO100/1
	20x20x0.8	RA 20/0.8
	30x30x0.8	RA 30/0.8

Уголок отделочный внутренний

	15x15x0.6	IC 15/0.6	
	15x15x0.8	IC 15/0.8	
	20x20x0.8	IC 20/0.8	
	30x30x0.8	IC 20/0.8	
	23x23x0.8	ICR 18/0.8	
	23x23x1	ICR 18/1	

Уголок равносторонний



	10x10	PA 10
	15x15	PA 15
	20x20	PA 20
	25x25	PA 25
	30x30	PA 30
	40x40x1	PA 40/1
	50x50x1	PA 50/1
	60x60x1	PA 60/1
	80x80x1	PA 80/1
	100x100x1	PA 100/1

ВИД	РАЗМЕР, мм	АРТИКУЛ
-----	------------	---------

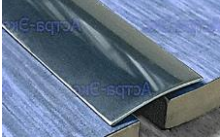
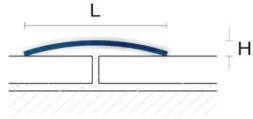
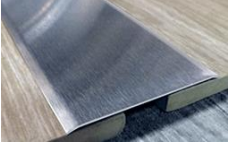
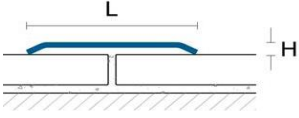
Стыковочный порог

		25	ST 25A
		30	ST 30A
		35	ST 35A
		ть пробивки одного отверстия 4.	
		40x0,8	CP 40
		50x0,8	CP 50
		60x1	CP 60/1
		80x1	CP 80/1
		100x1	CP 100/1
		150x1,2	CP 150/1,2

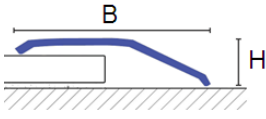
Соединительный порог для разновысотных полов

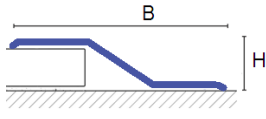
		30x5	RP 50
		35x8	RP 80
		40x10	RP 100
		ть пробивки одного отверстия 4.	
		5x36	DK 36
		10x42	DK 42
		16x48	DK 48

Полоса

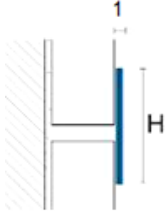
		20x0,8	PP 20
		30x0,8	PP 30
		40x0,8	PP 40
		40x1	PP 40/1
		60x1	PP 60/1
		80x1	PP 80/1
		100x1	PP 100/1
		150x1	PP 150/1
		200x1	PP 200/1
		300x1,2	PP 300/1,2

ВИД	РАЗМЕР, мм	АРТИКУЛ
-----	------------	---------

Компенсационные швы.

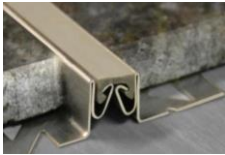
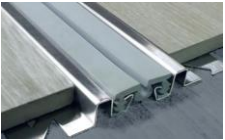
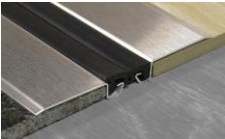
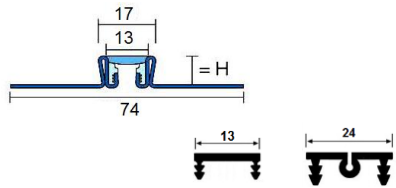
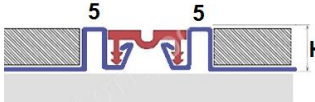
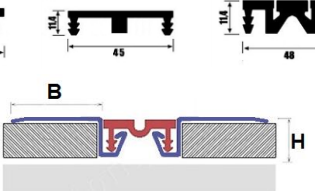
  		10	CB (CBL) 100	
		12,5	CB (CBL)125	
		15	CB (CBL)150	
		22	CB (CBL) 220	
		Резиновый уплотнитель 13 мм		
		Резиновый уплотнитель 24 мм		
			5x15	DSV 15
			5x30	DSV 30
		Резиновый уплотнитель 28 мм		
	Резиновый уплотнитель 45 мм			
	Резиновый уплотнитель 48 мм			
		55x13	DSN 55	
		65x13	DSN 65	

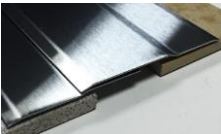
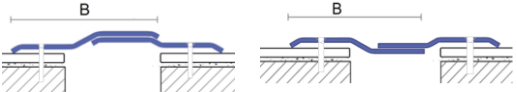
		85x1.2	CPD 110
		110x1.2	CPD 110

Накладки на деформационный шов

			
	цены рассчитываются по запросу		

Плинтус для установки панелей из гипсокартона.

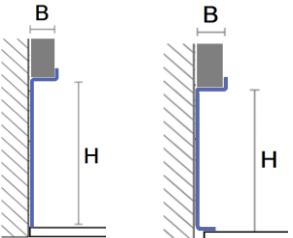

		70x15	BG 100/70
		100x15	BG 100/100

ВИД	РАЗМЕР, мм	АРТИКУЛ
-----	------------	---------

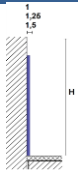
Линейный плинтус PP

 	60x1	PP 60/1
	80x1	PP 80/1
	90x1	PP 90/1
	100x1	PP 100/1
	120x1	PP 120/1

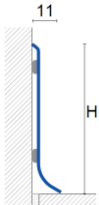
Плинтус пристеночный ВА аналог (790-Profilpas/ BTAC-Progress)



  	40x11x0,8	BA 40	угловые элементы из ПВХ поштучно
	50x11x0,8	BA 50	
	60x11x0,8	BA 60	
	70x18x0,8	BA 70	
	80x11x0,8	BA 80	
	100x11x0,8	BA 100	
	60x11x1	BA 60	
	80x11x1	BA 80	
	100x11x1	BA 100	
	120x11x1	BA 120	

угловые элементы из ПВХ поштучно

Плинтус плоский PKL

  	60x10x0,8	PKL 60/10
	80x10x0,8	PKL 80/10
	100x10x0,8	PKL 100/10

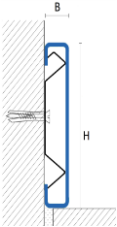
Плинтус с кабель-каналом BU

  	45x13	BU 45/13	угловые элементы из ПВХ поштучно заглушки, угловая накладка из нержавеющей стали крепежная клипса
	60x10	BU 60/10	
	80x14	BU 80/14	
	100x14	BU 100/14	
	120x14	BU 120/14	
	150x10	BU 150/10	

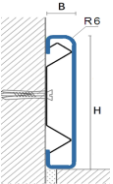
ВИД	РАЗМЕР, мм	АРТИКУЛ
	120x13	BR 120
	130x13	BR 130
	угловые элементы и ПВХ поштучно	
	заглушки из нержавеющей стали	
крепежная клипса		

Плинтус с кабель-каналом на клипсах VI

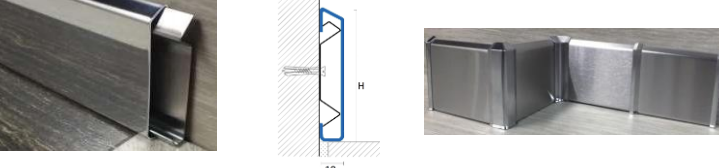
	70x10	VI 700
	100x10	VI 1000
	угловые элементы из ПВХ поштучно	
	крепежная клипса	

Плинтус с кабель-каналом под светодиодную подсветку

	80x14	BLL80
	заглушки, угловая накладка из нержавеющей стали	
	крепежная клипса	

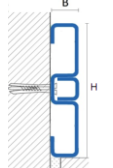
	45x13	BU 45/13/15
	60x10	BU 60/10/20
	80x14	BU 80/14/20
	угловые элементы из ПВХ поштучно	
заглушки, угловая накладка из нержавеющей стали		

Отбойник для стены

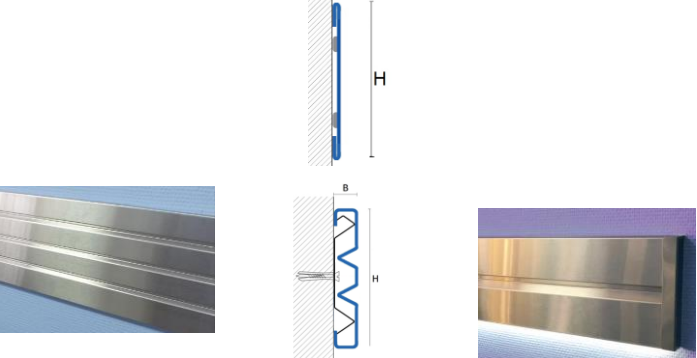
	200x0,8	
	300x0,8	
	200x20	
	300x20	
	200x20	с подсветкой
	заглушки из нержавеющей стали	
	крепежная клипса	

Изготовим профили по Вашим чертежам.

