

BG Ръководство за употреба	2	RU Инструкция по	
CS Návod k použití	33	эксплуатации	330
DE Benutzerinformation	62	SK Návod na používanie	362
EN User Manual	93	UK Інструкція	392
ES Manual de instrucciones	122		
FR Notice d'utilisation	151		
HU Használati útmutató	181		
IT Istruzioni per l'uso	210		
NL Gebruiksaanwijzing	241		
PL Instrukcja obsługi	270		
PT Manual de instruções	300		

USER MANUAL

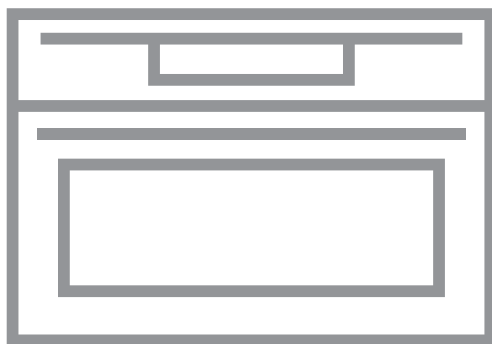

ЗА ОТЛИЧНИ РЕЗУЛТАТИ

Благодарим Ви, че избрахте продукт на AEG. Ние го създадохме, за да Ви предоставим безупречна експлоатация в продължение на много години, с иновативни технологии, които правят живота по-лесен – функции, които не можете да откриете при обикновените уреди. Моля, отделете няколко минути за четене, за да извлечете най-доброто. Посетете нашия уебсайт за:



Вижте полезни съвети за употреба, брошури, отстраняване на неизправности, информация за сервиз и ремонт:

www.aeg.com/support



Регистрирайте Вашия продукт за по-добро обслужване:

www.registeraeg.com



Купете аксесоари, консумативи и оригинални резервни части за Вашия уред:

www.aeg.com/shop

ОБСЛУЖВАНЕ НА КЛИЕНТИ

Винаги използвайте оригинални резервни части.

Когато се свързвате с нашия оторизиран отдел „Обслужване“, трябва да имате под ръка следната информация: Модел, PNC, сериен номер.

Информацията може да бъде открита на табелката с основни данни

 Предупреждение / Внимание – Информация за безопасност

 Обща информация и съвети

 Информация за околната среда

Запазваме си правото на изменения.

СЪДЪРЖАНИЕ

1. ИНФОРМАЦИЯ ЗА БЕЗОПАСНОСТ.....	3	4. КАК ДА ВКЛЮЧВАТЕ И ИЗКЛЮЧВАТЕ ФУРНАТА.....	11
1.1 Безопасност за деца и хора в неравностойно положение.....	3	4.1 Контролен панел.....	11
1.2 Обща безопасност.....	4	4.2 Екран.....	12
2. ИНСТРУКЦИИ ЗА БЕЗОПАСНОСТ.....	6	5. ПРЕДИ ПЪРВА УПОТРЕБА.....	13
2.1 Инсталация.....	6	5.1 Първоначално почистване	13
2.2 Електрическо свързване.....	8	5.2 Първо свързване.....	13
2.3 Използване.....	8	6. ВСЕКИДНЕВНА УПОТРЕБА.....	13
2.4 Грижа и почистване.....	9	6.1 Как да настроите функцията: Грил + МВ, Грил.....	13
2.5 Вътрешно осветление.....	9	6.2 Как да настроите: Функции за нагриване с микровълни.....	15
2.6 Обслужване.....	10	6.3 Начин на използване: Бърз старт на микровълновата.....	16
2.7 Изхвърляне.....	10	6.4 Функции за затопляне.....	16
3. ОПИСАНИЕ НА УРЕДА.....	10		
3.1 Общ преглед.....	10		
3.2 Аксесоари.....	10		

7. ФУНКЦИИ НА ЧАСОВНИКА.....	18	11. ГРИЖИ И ПОЧИСТВАНЕ.....	26
7.1 Описание на функциите на часовника.....	18	11.1 Бележки относно почистването.....	26
7.2 Как да настроите: Функции на часовника.....	18	12. ОТСТРАНЯВАНЕ НА НЕИЗПРАВНОСТИ.....	27
8. КАК ДА СЕ ИЗПОЛЗВА ПРИНАДЛЕЖНОСТИ.....	20	12.1 Как да постъпите, ако.....	27
8.1 Поставяне на аксесоари.....	20	12.2 Начин на управление: Кодове за грешка.....	28
9. ДОПЪЛНИТЕЛНИ ФУНКЦИИ.....	20	12.3 Данни за сервизно обслужване.....	28
9.1 Как да запазите: Предпочитани.....	20	13. ЕНЕРГИЙНА ЕФЕКТИВНОСТ.....	29
9.2 Заклучване на функция.....	21	13.1 Енергоспестяваща.....	29
9.3 Охлаждащ вентилатор.....	21	14. СТРУКТУРА НА МЕНЮТО.....	29
10. ПРЕПОРЪКИ И СЪВЕТИ.....	21	14.1 Меню.....	29
10.1 Препоръки за готвене.....	21	14.2 Подменю за: Опции.....	29
10.2 Препоръки за микровълново готвене.....	22	14.3 Подменю за: Настройка.....	30
10.3 Подходящи готварски съдове и материали за микровълнова.....	22	14.4 Подменю за: Сервиз.....	30
10.4 Препоръчителни настройки на мощността за различни видове храна.....	24	15. ЛЕСНО Е!.....	31
10.5 Таблици за готвене за изпитващи институции.....	25	16. ОПАЗВАНЕ НА ОКОЛНАТА СРЕДА.....	32

1. ⚠ ИНФОРМАЦИЯ ЗА БЕЗОПАСНОСТ

Преди монтирането и употребата на уреда внимателно прочетете предоставените инструкции. Производителят не е отговорен за наранявания или повреди в резултат на неправилна инсталация или употреба. Винаги дръжте инструкциите на безопасно и лесно достъпно място за справка в бъдеще.

1.1 Безопасност за деца и хора в неравностойно положение

- Този уред може да бъде използван от деца над 8-годишна възраст, както и от лица с намалени физически, сетивни и умствени възможности или от лица без опит и познания, само ако те са под наблюдение или бъдат инструктирани относно безопасната употреба на уреда и

разбират възможните рискове. Деца под 8-годишна възраст и хора с тежки или комплексни увреждания трябва да се държат далеч от уреда, освен ако не са под постоянно наблюдение.

- Децата трябва да бъдат под наблюдение, за да се гарантира, че не си играят с уреда.
- Дръжте всички опаковки далече от деца и изхвърлете опаковките по местните правила.
- **ПРЕДУПРЕЖДЕНИЕ:** Пазете децата и домашните любимци далече от уреда, когато работи или когато изстива. Има достъпни части, които се нагряват по време на употреба.
- Ако уредът има устройство за детска безопасност, то трябва да се активира.
- Деца не трябва да извършват почистване или поддръжка на уреда, когато са без надзор.

1.2 Обща безопасност

- Този уред е предназначен само за готвене.
- Този уред е предназначен за домашна употреба в затворени помещения.
- Този уред може да се използва в офиси, стаи в хотел, стаи в мотел, къщи за гости и други подобни места за настаняване, където това използване не надвишава (средно) нивото на домашна употреба.
- Само квалифицирано лице трябва да инсталира уреда и да смени кабела.
- Не използвайте уреда, преди да го инсталирате във вградената конструкция.
- Преди извършването на каквато и да е поддръжка, изключете уреда от електрозахранването.
- Ако захранващият кабел е повреден, той трябва да се смени от производителя, негов оторизиран сервизен център или квалифицирано лице, за да се избегне опасност.

- **ПРЕДУПРЕЖДЕНИЕ:** Уверете се, че уредът е изключен, преди да смените лампата, за да избегнете евентуален токов удар.
- **ПРЕДУПРЕЖДЕНИЕ:** Уредът и неговите достъпни части се нагорещават по време на употреба. Трябва да се внимава и да се избягва докосване на нагриващите се елементи.
- Винаги използвайте ръкавици за фурна при изваждане или поставяне на аксесоари или съдове за печене.
- Използвайте само шиша и опората му, които са предназначени за този уред.
- Не активирайте микровълновата функция, когато уредът е празен. Металните части във вътрешната част могат да създадат електрическа дъга.
- Метални контейнери за храна и напитки не се разрешават за готвене в микровълнова. Изискването не е приложимо, ако производителят конкретизира размер и форма на металните контейнери подходящи за микровълнова фурна.
- **ПРЕДУПРЕЖДЕНИЕ:** Ако вратата или уплътненията на вратата са повредени, уредът не трябва да работи, докато не бъде поправен от квалифицирано лице.
- **ПРЕДУПРЕЖДЕНИЕ:** Само квалифицирано лице може да извърши каквато и да е сервисна или ремонтна операция, която включва отстраняване на капак, който осигурява защита срещу излагане на микровълнова енергия.
- **ПРЕДУПРЕЖДЕНИЕ:** Не загрявайте течности и други храни в затворени съдове. Те могат да експлодират.
- Използвайте само съдове, които са подходящи за употреба в микровълнови фурни.
- При затопляне на храна в пластмасови или хартиени опаковки, проверявайте често фурната, поради опасност от запалване.

ИНСТРУКЦИИ ЗА БЕЗОПАСНОСТ

- Уредът е предназначен за затопляне на храни и напитки. Сушенето на храна или дрехи и нагриването на подгриващи подложки, чехли, гъби, влажни кърпи и други подобни може да доведе до риск от нараняване, запалване или пожар.
- Ако се отделя дим, изключете уреда от копчето или от контакта и дръжте вратата затворена, за да потушите пламъците, ако има такива.
- Микровълновото затопляне на напитки може да доведе до забавено еруптивно кипене. Трябва да се внимава при работа с контейнера.
- Съдържанието на бутилките за хранене и бурканите за бебешка храна се разбърква или разклаща, като температурата им трябва да се провери преди консумация, за да се избегнат изгаряния.
- Яйца с черупка и цели твърдо сварени яйца не трябва да се затоплят в уреда, тъй като могат да експлодират, дори след приключване на загряването в микровълновата фурна.
- Уредът трябва да се почиства редовно и да се отстраняват остатъците от храна.
- Не почиствайте уреда с парочистачка.
- Не използвайте груби, абразивни, почистващи препарати или остри, метални стъргалки за почистване на стъклото на вратата, защото те могат да надраскат повърхността и това да доведе до счупване на стъклото.
- Неподдържането на уреда в чисто състояние може да доведе до влошаване на повърхността, което може да повлияе неблагоприятно на живота на уреда и евентуално да доведе до опасна ситуация.

2. ИНСТРУКЦИИ ЗА БЕЗОПАСНОСТ

2.1 Инсталация

**ВНИМАНИЕ!**

Само квалифициран човек може да извърши монтажа на уреда.

ИНСТРУКЦИИ ЗА БЕЗОПАСНОСТ

- Махнете всички опаковки.
- Не монтирайте и не използвайте повреден уред.
- Следвайте инструкциите за инсталиране, приложени към уреда.
- Винаги внимавайте, когато местите уреда, тъй като е тежък. Винаги използвайте предпазни ръкавици и затворени обувки.
- Не дърпайте уреда за дръжката.
- Монтирайте уреда на безопасно и подходящо място, което отговаря на монтажните изисквания.
- Трябва да спазвате минималното разстояние до други уреди и устройства.
- Преди да монтирате уреда, проверете дали вратата на фурната се отваря безпроблемно.
- Уредът е оборудван с електрическа система за охлаждане. Трябва да се използва с електрозахранването.
- Вграденият уред трябва да отговаря на изискванията за стабилност на DIN 68930.

Минимална височина на отвора за вграждане (Минимална височина на отвора за вграждане под работния плот)	444 (460) мм
Ширина на отвора за вграждане	560 мм
Дълбочина на отвора за вграждане	550 (550) мм
Височина в предната част на уреда	455 мм
Височина в задната част на уреда	440 мм
Ширина в предната част на уреда	595 мм
Ширина в задната част на уреда	559 мм
Дълбочина на уреда	567 мм
Дълбочина на вграждане на уреда	546 мм
Дълбочина при отворена врата	882 мм
Минимален размер на отвора за вентилация. Отвор разположен в долната задна страна	560x20 мм
Дължина на основния захранващ кабел. Кабелът е разположен в десния ъгъл на задната страна	1500 мм
Монтажни винтове	3.5x25 мм

2.2 Електрическо свързване



ВНИМАНИЕ!

Риск от пожар или токов удар.

- Всички ел. връзки трябва да се направят от квалифициран електротехник.
- Уредът трябва да е заземен.
- Уверете се, че параметрите на табелката с технически данни са съвместими с електрическите данни на захранващата мрежа.
- Винаги използвайте правилно монтиран контакт със защита от токов удар.
- Не използвайте разклонители или адаптери с много входове.
- Внимавайте да не повредите захранващия щепсел и захранващия кабел. Ако захранващият кабел трябва да бъде подменен, това трябва да бъде извършено от нашия оторизиран сервизен център.
- Не допускайте захранващите кабели да се доближават до вратичката на уреда или пространството под него, особено когато е включен или когато вратичката е гореща.
- Защитата от токов удар на горещите и изолирани части трябва да бъде затегната по такъв начин, че да не може да се отстрани без инструменти.
- Свържете кабела за захранването към контакта единствено в края на инсталацията. Уверете се, че щепселът за захранване е достъпен след инсталирането.
- Ако контактът е разхлабен, не свързвайте захранващия щепсел.
- Не издърпвайте захранващия кабел, за да изключите уреда. Винаги издърпвайте щепсела на захранването.
- Използвайте само правилни устройства за изолация: предпазни прекъсвачи на мрежата, предпазители (предпазителите от винтов тип трябва да се извадят от фасунгата), изключватели и контактори за утечка на заземяването.
- Електрическата инсталация трябва да има изолиращо устройство, което Ви позволява да изключите уреда от ел. мрежата при всички полюси. Изолиращото устройство трябва да е с ширина на отваряне на контакта минимум 3 мм.
- Този уред се доставя с електрозахранващи щепсел и кабел.

2.3 Използване



ВНИМАНИЕ!

Риск от нараняване, изгаряния, токов удар или експлозия.

- Не променяйте предназначението на уреда.
- Уверете се, че вентилационните отвори не са блокирани.
- Не оставяйте уреда без надзор по време на работа.
- Изключвайте уреда след всяко използване.
- Бъдете внимателни, когато отваряте вратата на уреда, докато уредът работи. Може да излезе горещ въздух.
- Не работете с уреда с мокри ръце или когато има контакт с вода.
- Не оказвайте натиск върху отворената врата.
- Не използвайте уреда като работна повърхност или повърхност за съхранение.
- Отваряйте внимателно вратата на уреда. Използването на съставки с алкохол може да предизвика смесване на алкохол и въздух.
- Не позволявайте искри или открит пламък да влизат в контакт с уреда, когато отваряте вратата.

- Не поставяйте запалими продукти или предмети, които са намокрени със запалими продукти, в близост до уреда или върху него.
- Не използвайте микровълновата функция за подгриване на фурната.



ВНИМАНИЕ!

Опасност от повреда в уреда.

- За да се избегнат повреди и обезцветяване на емайла:
 - не поставяйте алуминиево фолио директно върху дъното на уреда.
 - не поставяйте вода директно в горещия уред.
 - не поставяйте влажни съдове и храна в уреда, след като приключите с готвенето.
 - бъдете внимателни, когато махате или поставяте аксесоарите.
- Обезцветяването на емайла или неръждаемата стомана не оказва влияние върху работата на уреда.
- Винаги гответе при затворена вратичка на уреда.
- Ако уредът е инсталиран зад преграда от мебелен тип, напр. зад вратичка в шкаф, тази вратичка трябва винаги да е отворена, докато уредът работи. Ако е затворена, могат да се акумулират топлина и влага, които впоследствие да повредят уреда, шкафа или пода. Не затваряйте преградата, докато уредът не изстине напълно след употреба.

2.4 Грижа и почистване



ВНИМАНИЕ!

Опасност от нараняване, пожар или повреда на уреда.

- Преди поддръжка изключете уреда и извадете щепсела на захранването от контакта на ел. мрежата.
- Уверете се, че уредът е студен. Има опасност стъклените панели да се счупят.
- Сменяйте незабавно стъклените панели на вратичката, когато са повредени. Свържете се с оторизиран сервизен център.
- Внимавайте, когато сваляте вратичката от уреда. Вратичката е тежка!
- Подсушавайте вътрешността, обръщателната платформа и вратичката след всяко използване. Изпусканата по време на работата на уреда пара се кондензира върху стените на вътрешността и може да предизвика корозия.
- Почиствайте редовно уреда, за да предотвратите разваляне на повърхностния материал.
- Остатъчни мазнини и храни в уреда, могат да причинят пожар или токов удар, когато работи микровълновата функция.
- Почистете уреда с мокра и мека кърпа. Използвайте само неутрални препарати. Не използвайте абразивни продукти, грапави, почистващи кърпи, разтворители или метални предмети.
- Ако използвате спрей за фурна, следвайте инструкциите за безопасност върху опаковката му.

2.5 Вътрешно осветление



ВНИМАНИЕ!

Опасност от токов удар.

- Относно лампата(ите) вътре в този продукт и резервните лампи, продавани отделно: Тези лампи са предназначени да издържат на екстремни физически условия в

ОПИСАНИЕ НА УРЕДА

домакински уреди, като температура, вибрации, влажност или са предназначени да сигнализират информация за работното състояние на уреда. Те не са предназначени за използване в други приложения и не са подходящи за осветяване на помещения в домакинството.

- Този продукт включва светлинен източник с клас на енергийна ефективност G.
- Използвайте само лампи със същите спецификации.

2.6 Обслужване

- За поправка на уреда се свържете с оторизирания сервизен център.
- Използвайте само оригинални резервни части.

2.7 Изхвърляне



ВНИМАНИЕ!

Риск от нараняване или задушаване.

- Свържете се с общинските власти за информация как да изхвърлите уреда.
- Изключете уреда от електрозахранването.
- Извадете захранващия ел. кабел в близост до уреда и го изхвърлете.
- Премахнете дръжката на вратичката, за да предотвратите заклепването на деца, или домашни любимци в уреда.

3. ОПИСАНИЕ НА УРЕДА

3.1 Общ преглед

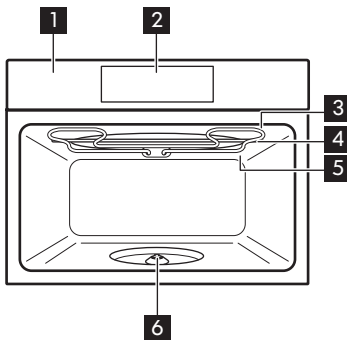

- 1 Контролен панел
- 2 Екран
- 3 Нагряващ елемент
- 4 Микровълнов генератор
- 5 Лампа
- 6 Въртящ се вал

3.2 Аксесоари

Комплек за шиш

За приготвяне на храна.

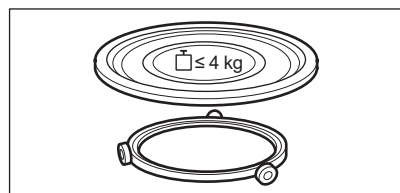

КАК ДА ВКЛЮЧВАТЕ И ИЗКЛЮЧВАТЕ ФУРНАТА

Комплект скари
За грил.

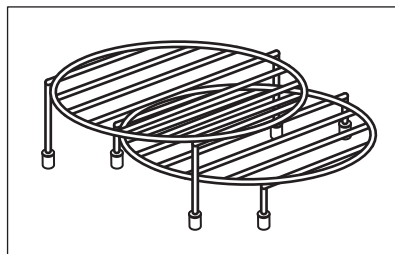

4. КАК ДА ВКЛЮЧВАТЕ И ИЗКЛЮЧВАТЕ ФУРНАТА

4.1 Контролен панел

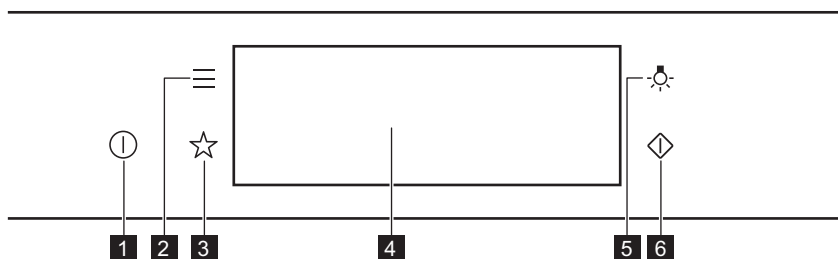

1	ВКЛ. / ИЗКЛ.	Натиснете и задръжете, за да включите и изключите фурната.
2	Меню	Изброява функциите на фурната.
3	Предпочитани	Изброява любимите настройки.
4	Екран	Показва текущите настройки на фурната.
5	Превключвател за лампичката	За включване и изключване на лампата.
6	Бърз старт на микровълновата	За включване на микровълновата функция (1000 W и 30 секунди).

 Натиснете	 Преместете	 Натиснете и задръжете
---------------	----------------	---------------------------

КАК ДА ВКЛЮЧВАТЕ И ИЗКЛЮЧВАТЕ ФУРНАТА

Докоснете повърхността с върха на пръста си.	Плъзнете пръста си по повърхността.	Докоснете повърхността за 3 секунди.
--	-------------------------------------	--------------------------------------

4.2 Екран

	<p>След включване се показва основният екран с функцията и интензивността на грила по подразбиране.</p> <p>A. Час от денонощието B. СТАРТ/СТОП C. Интензивност на грила D. Функции нагряване E. Микровълнова мощност F. Таймер</p>
	<p>Ако не използвате фурната над 2 минути, екранът преминава в режим на готовност.</p>
	<p>По време на готвене, екранът показва зададените функции и други налични опции.</p>

Индикатори на екрана

Основни индикатори - за навигиране по екрана.

<p>OK</p> <p>За потвърждаване на избора / настройката.</p>	<p><</p> <p>За връщане едно ниво назад в менюто.</p>	<p>↶</p> <p>За отмяна на последното действие.</p>	<p>☑</p> <p>За включване и изключване на опции.</p>
--	---	---	---

Звукова аларма индикатори за функции - когато зададеното време за готвене свърши, се чува сигнал.

<p>🔔</p> <p>Функцията е включена.</p>	<p>🔔 STOP</p> <p>Функцията е включена. Готвенето спира автоматично.</p>	<p>🔔</p> <p>Звуковата аларма е изключена.</p>
---------------------------------------	---	---

Индикатори на таймера



За настройване на функцията: Забавен старт.



За отмяна на настройката.



5. ПРЕДИ ПЪРВА УПОТРЕБА



ВНИМАНИЕ!

Вж. глава "Безопасност".

5.1 Първоначално почистване

		
<p>Стъпка 1</p>	<p>Стъпка 2</p>	<p>Стъпка 3</p>
<p>Извадете всички принадлежности от фурната.</p>	<p>Почистете фурната и принадлежностите с мека кърпа, топла вода и лек препарат за почистване.</p>	<p>Поставете принадлежностите във фурната.</p>

5.2 Първо свързване

Дисплеят показва приветствено съобщение след първото свързване.

Трябва да зададете: Език, Яркост на екрана, Звук на бутоните, Сила на звук. сигнал, Час от денонощието.

6. ВСЕКИДНЕВНА УПОТРЕБА



ВНИМАНИЕ!

Вж. глава "Безопасност".

6.1 Как да настроите функцията: Грил + МВ, Грил

Фурната може да издава звуци при използване на функцията: Грил + МВ. Те са нормални за тази функция.

Задаване на функцията: Грил + МВ

<p>Стъпка 1</p>	<p>Поставете долния грил рафт.</p>
------------------------	------------------------------------

ВСЕКИДНЕВНА УПОТРЕБА

Задаване на функцията: Грил + МВ	
Стъпка 2	Включете фурната. Дисплеят показва функцията на затопляне по подразбиране.
Стъпка 3	Натиснете символа на функцията на затопляне, за да влезете в подменюто.
Стъпка 4	Изберете функцията:  . Натиснете: OK.
Стъпка 5	Изберете нивото на интензивност на грила.
Функция	Ниво на интензивност на грила
Lo	Ниско
Hi	Високо
Стъпка 6	Натиснете: OK.
Стъпка 7	Натиснете: START .
STOP – натиснете, за да изключите фурната.	
Стъпка 8	Изключете фурната.

Микровълновата мощност е ограничена до 500W, когато използвате функцията: Грил + МВ.

Задаване на функцията: Грил	
Стъпка 1	Поставете най-високия грил рафт.
Стъпка 2	Включете фурната. Дисплеят показва функцията на затопляне по подразбиране.
Стъпка 3	Натиснете символа на функцията на затопляне, за да влезете в подменюто.

Задаване на функцията: Грил	
Стъпка 4	Изберете функцията:  . Натиснете: OK.
Стъпка 5	Изберете нивото на интензивност на грила.
Функция	Ниво на интензивност на грила
Lo	Ниско
Hi	Високо
Стъпка 6	Натиснете: OK.
Стъпка 7	Натиснете: START .
STOP - натиснете, за да изключите функцията.	
Стъпка 8	Изключете фурната.

6.2 Как да настроите: Функции за нагряване с микровълни

Стъпка 1	Включете фурната.
Стъпка 2	Натиснете символа на функцията на затопляне, за да влезете в подменюто.
Стъпка 3	Изберете функцията на микровълново затопляне и натиснете: OK. Екранът показва: мощността на микровълновата.
Стъпка 4	Задайте: мощност на микровълновата. Натиснете: OK.
Стъпка 5	Натиснете: START .
STOP - натиснете, за да изключите функцията.	
Стъпка 6	Изключете фурната.

ВСЕКИДНЕВНА УПОТРЕБА

Максималното времетраене на микровълновата функция зависи от зададената мощност:

МОЩНОСТ НА МИКРОВЪЛНОВА	МАКСИМАЛНО ВРЕМЕ
100 – 600W	59 минути
Повече от 600W	7 минути



Ако отворите вратичката, функцията спира. За да стартирате отново, натиснете **START**.

Изберете клавиш за бърз достъп!

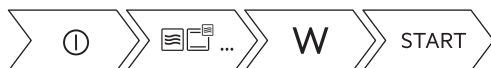



6.3 Начин на използване: Бърз старт на микровълновата

Стъпка 1	Натиснете и задръжте. . Микровълновата функция ще работи 30 сек.	
Стъпка 2	За да увеличите времето за готвене:	
	Натиснете стойността за време, за да преминете на настройките за време. Задайте на времето за готвене.	Натиснете +30 s.
Микровълновата може да бъде включена по всяко време с/с: Бърз старт на микровълновата.		





6.4 Функции за затопляне

СТАНДАРТНИ

Функция за затопляне	Приложение
 Грил	За запичане на тънки храни или препичане на хляб.

Функция за затопляне	Приложение
 Грил + МВ	За готвене на храна за кратко време и препичане. Можете да зададете 2 нива на интензивност на грила: ниско и високо.
 Микровълни	Загриване, готвене, обхват на мощността: 100 - 1000 W

МИКРОВЪЛНИ

Функция за затопляне	Приложение
 Размразяване	Размразяване на месо, риба, кейкове, обхват на мощността: 100 - 200 W
 Топене	Разтапяне на шоколад и масло, обхват на мощността: 100 - 400 W
 Затопляне	Затопляне на предварително приготвени и фини храни, обхват на мощността: 300 - 700 W
 Пуканки	Приготвяне на пуканки, обхват на мощността: 700 - 1000 W
 Течности	Загриване на напитки и супи, обхват на мощността: 800 - 1000 W

7. ФУНКЦИИ НА ЧАСОВНИКА



7.1 Описание на функциите на часовника

Функция Часовник	Приложение
Време за готвене	За да зададете времетраене на готвенето. Максимумът е 23 ч. и 59 мин.
Прекратяване на действието	За настройване какво да се случи при края на отброяването на таймера.
Удължаване на времето	За увеличаване на времето за готвене.
Напомняне	За настройка на обратно броене. Максимумът е 23 ч. и 59 мин. Тази функция не влияе върху работата на фурната.
Брояч	Седи колко време работи функцията. Брояч – можете да я включвате и изключвате.

7.2 Как да настроите: Функции на часовника

Как да настроите часовника	
Стъпка 1	Натиснете: Час от денонощието.
Стъпка 2	Настройте таймера. Натиснете: ОК.

Как да настроите времето за готвене	
Стъпка 1	Изберете функцията за затопляне.
Стъпка 2	Натиснете:  .
Стъпка 3	Настройте таймера. Натиснете: ОК.

Как да изберете опция за край	
Стъпка 1	Изберете функцията за затопляне.
Стъпка 2	Натиснете:  .
Стъпка 3	Задайте времето за готвене.
Стъпка 4	Натиснете:  .
Стъпка 5	Натиснете: Прекратяване на действието.
Стъпка 6	Изберете предпочитания: Прекратяване на действието.
Стъпка 7	Натиснете: OK. Повторете действието, докато на дисплея се покаже основният екран.

Как да удължите времето за готвене	
Когато остава 10% от времето за готвене, а изглежда, че храната не е готова, можете да удължите времето за готвене. Можете също да промените и функцията на затопляне.	
Натиснете +1 мин. , за да удължите времето за готвене.	

Как да промените настройките на таймера	
Стъпка 1	Натиснете:  .
Стъпка 2	Настройте стойността на таймера.
Стъпка 3	Натиснете: OK.
Можете да промените във всеки момент зададеното време докато готвите.	

8. КАК ДА СЕ ИЗПОЛЗВА ПРИНАДЛЕЖНОСТИ

8.1 Поставяне на аксесоари

Използвайте само подходящи готварски съдове и материал. Вижте глава „Полезни съвети“, Съдове и материали, подходящи за микровълнови фурни.

Комплек за шиш:

Винаги гответе храната върху въртящата се поставка.

Поставете водача около въртящата се поставка. Поставете стъклената част на въртящата се поставка върху водача. Използвайте само набора на въртящата се поставка, доставен заедно с фурната.

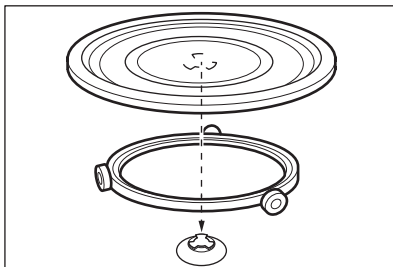

Комплект скари:

Поставете скарата на грила със силиконовите поставки надолу върху въртящата се поставка.

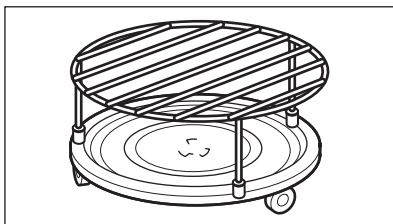

9. ДОПЪЛНИТЕЛНИ ФУНКЦИИ

9.1 Как да запазите: Предпочитани



Можете да запазите любимите си настройки, като функцията на затопляне, времето за готвене или функцията за почистване. Можете да запазите 3 любими настройки.

Стъпка 1	Включете фурната.
Стъпка 2	Изберете предпочитаната функция.
Стъпка 3	Натиснете:  Select (Изберете): Предпочитани.
Стъпка 4	Изберете: Запази текущите настройки.

Стъпка 5	Натиснете + , за да добавите настройката към списъка със: Предпочитани. Натиснете OK .
<p>↶ - натиснете, за да нулирате настройката.</p> <p>⊗ - натиснете, за да отмените настройката.</p>	

9.2 Заклучване на функция

Тази функция предотвратява случайна промяна на функцията за затопляне.

Стъпка 1	Включете фурната.
Стъпка 2	Задайте функция за затопляне.
Стъпка 3	  – натиснете едновременно, за да включите функцията.
За да изключите функцията, повторете стъпка 3.	

9.3 Охлаждащ вентилатор

Когато фурната работи, охлаждащият вентилатор се включва автоматично, за да поддържа повърхностите на фурната хладни. Ако изключите фурната, вентилаторът за охлаждане може да продължи да работи, докато фурната се охлади.

10. ПРЕПОРЪКИ И СЪВЕТИ

10.1 Препоръки за готвене

<p>Температурата и времето за готвене в таблиците са само ориентировъчни. Те зависят от рецептите, качеството и количеството на използваните съставки.</p> <p>Вашата фурна може да пече по-различно от досегашната Ви фурна. Съветите по-долу показват препоръчаните функции нагряване и настройки за времето за готвене за специфични типове храна.</p> <p>Ако не можете да намерите настройките за специална рецепта, потърсете подобни рецепти. За повече препоръки за готвене вижте таблиците за готвене на нашия уебсайт. За да откриете подходящата книжка с рецепти, проверете PNC (номер на продукт) на фирмената табела от предната част на уреда.</p>

10.2 Препоръки за микровълново готвене

Хайде да готвим!

Не поставяйте храна директно върху въртящата се повърхност. Винаги използвайте съдове, подходящи за микровълнова фурна.

Поставете готварските съдове в центъра на въртящата се повърхност.

Допирът между два прекалено горещи или прекалено студени предмета може да счупи въртящата се повърхност.

Обърнете или разбъркайте храната по средата на времето за размразяване или готвене.

От време на време разбърквайте течните ястия.

Разбърквайте храната преди сервиране.

Покрийте храната при готвене и претопляне.

Поставете лъжицата към бутилката или чашата, когато затопляте напитки, за да се гарантира по-добро разпределение на топлината.

Поставете храната във фурната без опаковки. Пакетираните готови храни могат да бъдат поставени във фурната само, когато опаковката е подходяща за микровълнова фурна (прочетете информацията върху опаковката).



Готвене в микровълнова фурна

Гответе в покрит съд. Ако искате храната да е хрупкава, гответе без капак.

Не прекалявайте с готвенето на ястията, като изберете прекалено висока настройка на мощността и прекалено дълго време. Храната може да изсъхне, да изгори или да предизвика пожар.

Не използвайте фурната за приготвяне на яйца или охлуви с черупки, защото те могат да се пръснат. Продупчете жълтъка на пържените яйца, преди да ги претоплите.

Преди готвене продупчете храната с кожа или кора няколко пъти.

Нарежете зеленчуците на парченца с подобни размери.

След като изключите фурната, извадете храната и я оставете да престои няколко минути, като така топлината ще се разпредели равномерно.



Размразяване в микровълнова фурна

Поставете замразената и неразопакована храна върху малка обърната наобратно чиния със съд под нея, на поставката за размразяване или пластмасово сито, за да се събира течността от размръзване.

Отстранете размразените парчета последователно.

За приготвяне на плодове и зеленчуци без да ги размразявате, може да използвате микровълновата фурна на по-висока мощност.

10.3 Подходящи готварски съдове и материали за микровълнова

Използвайте само подходящи готварски съдове и материали за микровълновата фурна.





Използвайте долната таблица за справка.

Проверете спецификациите на съдовете за готвене / материала преди употреба.

ПРЕПОРЪКИ И СЪВЕТИ



Готварски съдове / Материал				
Огнеупорно стъкло или порцелан без метални части, напр. огнеупорно стъкло	✓	✓	✓	✓
Неогнеупорно стъкло и порцелан без сребърни, златни, платинени или други метални декорации	✓	x	x	x
Стъкло и стъклокерамика, изработени от огнеупорен / устойчив на замръзване материал	✓	✓	✓	✓
Керамични и глинени съдове без кварцови или метални компоненти и покрития, които съдържат метал	✓	✓	x	x
Керамика, порцелан и глинени съдове с неглазирано дъно или с малки отвори, напр. на дръжките	x	x	x	x
Пластмаса, устойчива на топлина до 200°C	✓	✓	x	x
Картон, хартия	✓	x	x	x
Домакинско прозрачно фолио	✓	x	x	x
Фолио за печене с безопасно затваряне в микровълнова фурна	✓	✓	x	x
Съдове за печене от метал, напр. емайл, чугун	x	x	✓	x
Тави за печене, покрити с черен лак или силикон	x	x	✓	x

ПРЕПОРЪКИ И СЪВЕТИ

Готварски съдове / Материал				
Готварски съдове за употреба в микровълнова фурна, напр. плитка тава	X	✓	X	X
Комплект скари за грил	X	X	✓	✓





10.4 Препоръчителни настройки на мощността за различни видове храна

Данните в таблицата са само ориентировъчни.

800 - 1000W	
 Запечатване в началото на процеса на готвене	 Затопляне на течности

500 - 700 W					
 Готвене на зеленчуци	 Готвене на ястия с яйца	 Задушено месо на ба- вен огън	 Варене на ориз на тих огън	 Затопляне на ястия в един съд	 Размразя- ване и за- топляне на замразени храни

300 - 400 W		
 Топене на сирене, шоколад, масло	 Готвене / Затопляне на фини хранителни продукти	 Продължително готвене

100 – 200W				
 Затопляне на бебешка храна	 Размразяване на хляб	 Размразяване на плодове и сладкиши	 Размразяване на сирене, сметана, мас- ло	 Размразяване на месо, риба

10.5 Таблицы за готвене за изпитващи институции.





Информация за изпитващи лаборатории

Изпитвания съгласно IEC 60705.

МИКРОВЪЛНО- ВА ФУНКЦИЯ	 POWER (W)	 (кг)		 (мин.)	
Пандишпанов кейк	600	0.475	Въртяща се по- ставка	5 - 7	-
Руло „Стефани“	500	0.9	Въртяща се по- ставка	18 - 20	-
Яйчен крем	500	1	Въртяща се по- ставка	15 - 17	-
Размразяване на месо	200	0.5	Въртяща се по- ставка	8 - 9	-

ГРИЖИ И ПОЧИСТВАНЕ

Използвайте функцията: Печене на микровълнова фурна.
Използвайте долния грил рафт.

КОМБИНИРАНА МИКРОВЪЛНОВА ФУНКЦИЯ	 POWER (W)	 Ниво на интензивност на грила	 (мин.)	
Запечени картофи, 1,1 кг	300	ниско	30 - 35	-
Пиле, 1,1 кг	300	високо	30 - 35	Поставете месото в кръгъл стъклен съд.

11. ГРИЖИ И ПОЧИСТВАНЕ



ВНИМАНИЕ!

Вж. глава "Безопасност".

11.1 Бележки относно почистването



Препарати за почистване

Почистете лицевата част на фурната с мека кърпа с топла вода и лек препарат за почистване.

Използвайте почистващ разтвор, за да почистите металните повърхности.

Почистете петната с лек почистващ препарат.



Всекидневна употреба

Почиствайте вътрешността след всяка употреба. Натрупвания на мазнини или други остатъци могат да доведат до пожар. Внимателно почиствайте тавана на фурната от остатъци и мазнина.

Не съхранявайте храната във фурната за повече от 20 минути. Подсушавайте вътрешността на фурната с мека кърпа след всяка употреба.



Акcesoари

Почиствайте принадлежностите на фурната след всяко ползване и ги оставайте да изсъхнат. Преди почистване изчакайте въртящата се поставка да изстине. Има опасност въртящата се поставка да се счупи. Използвайте мека кърпа с топла вода и лек почистващ препарат. Не почиствайте принадлежностите в съдомиялна.

Не почиствайте незалепващите акcesoари с абразивно почистващо средство или предмети с остри ръбове.

12. ОТСТРАНЯВАНЕ НА НЕИЗПРАВНОСТИ



ВНИМАНИЕ!

Вж. глава "Безопасност".

12.1 Как да постъпите, ако...



Фурната не се включва или не загрива



Възможна причина



Решение

Фурната не е свързана към електрозахранването или е свързана неправилно.

Проверете дали фурната е свързана правилно към електрозахранването.

Часовникът не е настроен.

Настройте часовника, за подробности вижте глава „Функции на часовника“; Как да направите настройката: Функции на часовника.

Вратата не е добре затворена.

Затворете плътно вратата.



Предпазителят е изгорял.

Проверете дали предпазителят е причина за неизправността. Ако проблемът се появи отново, обадете се на квалифициран техник.

Функцията „Защита за деца“ е включена.



Вижте глава „Меню“, подменю за: Опции.

ОТСТРАНЯВАНЕ НА НЕИЗПРАВНОСТИ

 Компоненти	
 Описание	 Решение
Лампичката е изгоряла.	Сменете лампичката, за подробности вижте глава „Грижа и почистване“, Начин на подмяна: Лампа.
Въртящата се поставка издава шум.	Има остатъци от храна под въртящата се поставка.

12.2 Начин на управление: Кодове за грешка

При наличие на софтуерна грешка на дисплея се извежда съобщение за грешка. В този раздел ще откриете списък с проблеми, които може да разрешите сами.

 Код и описание	 Отстраняване
F240, F439 – сензорните полета на дисплея не работят правилно.	Почистете повърхността на дисплея. Уверете се, че сензорните полета не са замърсени.
F908 – системата на фурната не е в състояние да се свърже с контролния панел.	Изключете и включете фурната.

12.3 Данни за сервизно обслужване

Ако не можете да намерите решение на проблема сами, обърнете се към търговеца си или към упълномощен сервизен център.

Данните, необходими за сервизния център, са посочени на табелката с данни. Табелката с данни се намира на предната рамка на вътрешността на фурната. Не отстранявайте табелката с данни от вътрешността на фурната.

Препоръчваме Ви да запишете данните тук:	
Модел (MOD.)
Номер на продукт (PNC)
Сериен номер (S.N.)

13. ЕНЕРГИЙНА ЕФЕКТИВНОСТ

13.1 Енергоспестяваща



Фурната съдържа функции, които ви позволяват да спестявате енергия при ежедневното готвене.

Уверете се, че вратата на фурната е затворена, когато фурната работи. Не отваряйте вратата на фурната твърде често по време на готвене. Поддържайте уплътнението на вратата чисто и се уверете, че е добре фиксирано в своята позиция.

Когато е възможно, не загревайте предварително фурната, преди готвене.

Когато пригответе няколко ястия наведнъж, свеждайте интервалите между готвенето им до минимум.

Готвене с изключена лампичка

Изключете лампичката по време на готвене. Включвайте я само, когато имате нужда от нея.

14. СТРУКТУРА НА МЕНЮТО

14.1 Меню

Натиснете , за да отворите Меню.

Елемент от менюто		Приложение
Предпочитани		Изброява любимите настройки.
Опции		За задаване на конфигурацията на фурната.
Настройки	Настройка	За задаване на конфигурацията на фурната.
	Сервиз	Показва конфигурацията и версията на софтуера.

14.2 Подменю за: Опции

Подменю	Приложение
Осветление	Включва и изключва лампата.

СТРУКТУРА НА МЕНЮТО

Подменю	Приложение
Защита за деца	Предотвратява случайно активиране на фурната. Когато опцията е включена, при включване на фурната текстът "Защита за деца" се появява на екрана. За да активирате фурната, изберете кодовите букви по азбучен ред. Достъпът до таймера, дистанционното управление и лампичката е възможен с включена Защита за деца.
Посочване на времето	Включва и изключва часовника.
Дигиталнен часовник	Сменя формата на показваната индикация за време.

14.3 Подменю за: Настройка

Подменю	Описание
Език	Задава езика за опрaвление.
Яркост на екрана	Задава яркостта на екрана.
Звук на бутоните	Включва и изключва звука при натискане на сензорните полета. Не е възможно да заглушите звука за: ①.
Сила на звук. сигнал	Задава силата на звука на бутоните и сигналите.
Час от денонощието	Задава текущите час и дата.

14.4 Подменю за: Сервиз

Подменю	Описание
Демо режим	Код за активация/деактивация: 2468
Софтуерна версия	Информация относно софтуерната версия.
Зануляване на настройките	Възстановява фабричните настройки.

15. ЛЕСНО Е!

Преди първата употреба, трябва да настроите:

Език	Яркост на екрана	Звук на бутоните	Сила на звук сигнал	Час от денонощието
------	------------------	------------------	---------------------	--------------------

Запознайте се с основните икони на контролния панел и екрана:

 ВКЛ. / ИЗКЛ.	 Меню	 Предпочитани	 Таймер	START / STOP
--	--	--	--	--------------

Започнете да използвате фурната

Бърз старт на MW	Стартирайте микровълновата фурна по всяко време с настройките по подразбиране: 30 сек / 1000W.	Натиснете:  .
-------------------------	--	--



			
загряване / готвене 100 - 1000 Вт	готвене / запичане интензивност: ниска / висока	готвене / запичане	затопляне на течности 800 - 1000 Вт
			
претопляне 300 - 700 Вт	размразяване 100 - 200 Вт	разтопяване 100 - 400 Вт	приготвяне на пуканки 700 - 1000 Вт

Настройки на микровълновата		Съвети за микровълновата
Микровълнова мощност:	Максимално време:	Покрийте храната при готвене и претопляне. Обърнете или разбъркайте храната по средата на времето за размразяване или готвене. Поставете лъжицата в съда, когато загряват течности. Поставете храната във фурната без опаковка (само такава, която е подходяща за микровълнова).
100 – 600 Вт	59 мин	
> 600 Вт	7 мин	

Започнете да готвите				
Стъпка 1	Стъпка 2	Стъпка 3	Стъпка 4	Стъпка 5
 - натиснете, за да включите фурната.	 ... - изберете функцията.	Вт - задайте мощността на микровълновата функция.	ОК - натиснете, за да потвърдите.	START - натиснете, за да започнете готвенето.

Използвайте бързите функции, за да зададете времето за готвене	
10% финален асистент Използвайте 10% финален асистент, за да добавите допълнително време, когато остане 10% от времето за готвене.	За да увеличите времето за готвене, натиснете +1min.

16. ОПАЗВАНЕ НА ОКОЛНАТА СРЕДА

Рециклирайте материалите със символа . Поставете опаковките в съответните контейнери за рециклирането им. Помогнете за опазването на околната среда и човешкото здраве, както и за рециклирането на отпадъци от електрически и електронни уреди. Не изхвърляйте уредите, означени със символа , заедно с битовата смет. Върнете уреда в местния пункт за рециклиране или се обърнете към вашата общинска служба.

PRO DOKONALÉ VÝSLEDKY

Děkujeme vám, že jste si zvolili výrobek značky AEG. Aby vám bezchybně sloužil mnoho let, vyrobili jsme jej s pomocí inovativních technologií, které usnadňují život, a vybavili funkcemi, které u obyčejných spotřebičů nespíš nenajdete. Aby vám sloužil co nejlépe, stačí věnovat pár minut čtení.

Navštivte naše webové stránky:



Rady k používání, brožury, poradce při potížích a informace o servisu a opravách získáte na:

www.aeg.com/support



Zaregistrujte svůj spotřebič a získejte lepší servis:

www.registreaeg.com



Nákup příslušenství, spotřebního materiálu a originálních náhradních dílů pro váš spotřebič:

www.aeg.com/shop

PÉČE O ZÁKAZNÍKY A SERVIS

Doporučujeme používat originální náhradní díly.

V případě kontaktování našeho autorizovaného servisního střediska mějte u sebe následující údaje: Model, výrobní číslo, sériové číslo.

Tyto informace naleznete na typovém štítku.

 Varování / Důležité bezpečnostní informace

 Všeobecné informace a rady

 Informace o ochraně životního prostředí

Změny vyhrazeny.

OBSAH

1. BEZPEČNOSTNÍ INFORMACE.....	34	3. POPIS SPOTŘEBIČE.....	41
1.1 Bezpečnost dětí a zranitelných osob.....	34	3.1 Celkový pohled.....	41
1.2 Všeobecné bezpečnostní informace.....	35	3.2 Příslušenství.....	41
2. BEZPEČNOSTNÍ POKYNY	37	4. JAK ZAPNOUT A VYPNOUT TROUBU...41	
2.1 Instalace.....	37	4.1 Ovládací panel.....	41
2.2 Připojení k elektrické síti.....	38	4.2 Displej.....	42
2.3 Použití.....	39	5. PŘED PRVNÍM POUŽITÍM.....	43
2.4 Čištění a údržba.....	39	5.1 První čištění	44
2.5 Vnitřní osvětlení.....	40	5.2 První připojení.....	44
2.6 Servis.....	40	6. DENNÍ POUŽÍVÁNÍ.....	44
2.7 Likvidace.....	40	6.1 Jak nastavit funkci: Gril + MV, Gril.....	44

6.2 Jak nastavit: Mikrovlnné pečicí funkce.....	46	10.4 Doporučená nastavení výkonu pro různé druhy pokrmů.....	53
6.3 Jak použít: Rychlý start mikrovlnné trouby.....	46	10.5 Tabulky vaření pro zkušební.....	54
6.4 Pečicí funkce.....	47	11. ČIŠTĚNÍ A ÚDRŽBA.....	55
7. FUNKCE HODIN.....	48	11.1 Poznámky k čištění.....	55
7.1 Popis funkcí hodin.....	48	12. ODSTRAŇOVÁNÍ ZÁVAD.....	56
7.2 Jak nastavit: Funkce hodin.....	48	12.1 Co dělat, když.....	56
8. POUŽITÍ: PŘÍSLUŠENSTVÍ.....	49	12.2 Jak spravovat: Chybové kódy.....	57
8.1 Vkládání příslušenství.....	49	12.3 Servisní údaje.....	57
9. DOPLŇKOVÉ FUNKCE.....	50	13. ENERGETICKÁ ÚČINNOST.....	58
9.1 Jak uložit: Oblíbené.....	50	13.1 Úspora energie.....	58
9.2 Blokování tlačítek.....	50	14. STRUKTURA NABÍDKY.....	58
9.3 Chladicí ventilátor.....	51	14.1 Nabídka.....	58
10. TIPY A RADY.....	51	14.2 Dílčí nabídka pro: Funkce.....	58
10.1 Doporučení k pečení.....	51	14.3 Dílčí nabídka pro: Nastavení.....	59
10.2 Doporučení k mikrovlnné troubě.....	51	14.4 Podnabídka pro: Obsluha.....	59
10.3 Nádobí a materiály vhodné do mikrovlnné trouby.....	52	15. JE TO SNADNÉ!.....	59
		16. POZNÁMKY K OCHRANĚ ŽIVOTNÍHO PROSTŘEDÍ.....	61

1. ⚠️ BEZPEČNOSTNÍ INFORMACE

Tento návod si pečlivě přečtěte ještě před instalací spotřebiče a jeho prvním použitím. Výrobce nenese odpovědnost za žádný úraz ani škodu v důsledku nesprávné instalace nebo použití. Návod k použití vždy uchovávejte na bezpečném a přístupném místě pro jeho budoucí použití.

1.1 Bezpečnost dětí a zranitelných osob

- Tento spotřebič smí používat děti starší osmi let nebo osoby se sníženými fyzickými, smyslovými nebo duševními schopnostmi nebo osoby bez patřičných zkušeností a znalostí, pouze pokud tak činí pod dozorem nebo obdržely instrukce týkající se bezpečného provozu spotřebiče a pokud rozumí rizikům spojeným s provozem spotřebiče. Děti mladší osmi let a osoby s rozsáhlým a komplexním postižením bez stálého dozoru udržujte z dosahu spotřebiče.

- Nenechte děti hrát si se spotřebičem.
- Všechny obaly uschovejte mimo dosah dětí a řádně je zlikvidujte.
- **VAROVÁNÍ:** Je-li spotřebič v provozu nebo pokud chladne, nedovolte dětem a domácím zvířatům, aby se k němu přibližovaly. Přístupné části se při použití zahřívají na vysokou teplotu.
- Je-li spotřebič vybaven dětskou bezpečnostní pojistkou, doporučuje se ji aktivovat.
- Čištění a uživatelskou údržbu spotřebiče by neměly provádět děti bez dozoru.

1.2 Všeobecné bezpečnostní informace

- Spotřebič je určen výhradně pro přípravu jídel.
- Tento spotřebič je určen k použití v běžné nespolečné domácnosti ve vnitřních prostorách.
- Tento spotřebič lze používat v kancelářích, hotelových pokojích, motelech, agropenzionech a v podobných ubytovacích zařízeních, kde využití nepřesahuje (průměrnou) úroveň využití v domácnosti.
- Tento spotřebič smí instalovat a výměnu kabelu provádět jen kvalifikovaná osoba.
- Nepoužívejte spotřebič, dokud není nainstalován do vestavné konstrukce.
- Před prováděním jakékoli údržby vždy spotřebič odpojte od napájení.
- Je-li napájecí kabel poškozený, smí ho vyměnit pouze výrobce, autorizované servisní středisko nebo osoby s podobnou příslušnou kvalifikací. Jinak by mohlo dojít k úrazu elektrickým proudem.
- **VAROVÁNÍ:** Před výměnou žárovky se ujistěte, že je spotřebič vypnutý, abyste zabránili možnému úrazu elektrickým proudem.

- **VAROVÁNÍ:** Spotřebič a jeho přístupné části se při použití zahřívají na vysokou teplotu. Nedotýkejte se topných článků.
- Při vkládání nebo vyjímání příslušenství či nádobí vždy používejte kuchyňské chňapky.
- Používejte pouze otočný talíř a nosič talíře určený pro tento spotřebič.
- Je-li spotřebič prázdný, nezapínejte funkci mikrovlnné trouby. Kovové součásti uvnitř trouby mohou způsobit elektrický oblouk.
- Pro přípravu pokrmů a nápojů v mikrovlnné troubě nesmí být použity kovové nádoby. Tento požadavek neplatí, pokud výrobce stanoví velikost a tvar kovových nádob, které jsou vhodné pro přípravu v mikrovlnné troubě.
- **VAROVÁNÍ:** Jsou-li poškozena dvířka nebo těsnění dvířek, nesmí se spotřebič používat, dokud jej neopraví kvalifikovaná osoba.
- **VAROVÁNÍ:** Opravy či údržbu, které zahrnují sejmutí krytu chránícího před vystavením mikrovlnné energii, může provádět pouze kvalifikovaná osoba.
- **VAROVÁNÍ:** Tekutiny a další potraviny neohřívejte v uzavřených nádobách. Mohly by vybuchnout.
- Používejte pouze nádobí vhodné k použití v mikrovlnných troubách.
- Při ohřívání potravin v plastových či papírových nádobách sledujte spotřebič z důvodu jejich možného vznícení.
- Spotřebič je určen k ohřívání potravin a nápojů. Sušení potravin nebo oděvů a ohřívání zahřívacích podložek, pantoflů, houbiček, vlhkých hadrů a podobných předmětů může vést k poranění, vznícení nebo požáru.
- Uvolňuje-li se ze spotřebiče kouř, vypněte jej nebo vypojte ze zásuvky a dvířka nechte zavřená, aby se případné plameny udusily.
- Ohřívání nápojů v mikrovlnné troubě může mít za následek zpožděný eruptivní var. Při manipulaci s nádobou je třeba dbát opatrnosti.

- Obsah kojeneckých lahví a skleniček s dětskou výživou by měl být před konzumací zamíchán nebo protřepán a ověřena jeho teplota, aby nedošlo k popálení.
- Vajíčka ve skořápce a celá vajíčka vařená natvrdo by se neměla ve spotřebiči ohřívat, protože mohou explodovat, a to i po dokončení mikrovlnného ohřevu.
- Spotřebič je nutné pravidelně čistit a odstraňovat jakékoliv zbytky potravin.
- K čištění spotřebiče nepoužívejte čisticí zařízení na páru.
- K čištění skleněných dvířek nepoužívejte drsné čisticí prostředky nebo ostré kovové škrabky. Mohly by poškrábat povrch, což by mohlo následně vést k rozbití skla.
- Nebudete-li udržovat spotřebič čistý, může to vést k poškození povrchu, které by mohlo nepříznivě ovlivnit životnost spotřebiče a vést k nebezpečným situacím.

2. BEZPEČNOSTNÍ POKYNY

2.1 Instalace



VAROVÁNÍ!

Tento spotřebič smí instalovat jen kvalifikovaná osoba.

- Odstraňte veškerý obalový materiál.
- Poškozený spotřebič neinstalujte ani nepoužívejte.
- Řiďte se pokyny k instalaci dodanými spolu s tímto spotřebičem.
- Při přemísťování spotřebiče buďte vždy opatrní, protože je těžký. Vždy používejte ochranné rukavice a uzavřenou obuv.
- Netahejte spotřebič za držadlo.
- Spotřebič nainstalujte na bezpečném a vhodném místě, které splňuje požadavky na instalaci.
- Dodržujte minimální vzdálenosti od ostatních spotřebičů a nábytku.
- Před instalací spotřebiče ověřte, zda se dvířka trouby otevírají bez omezení.
- Spotřebič je vybaven elektrickým chladicím systémem. Musí být zapojen do elektrické sítě.
- Vestavná jednotka musí splňovat požadavky na stabilitu dle normy DIN 68930.

Minimální výška skříňky (minimální výška skříňky pod pracovní deskou)	444 (460) mm
Šířka skříňky	560 mm
Hloubka skříňky	550 (550) mm

BEZPEČNOSTNÍ POKYNY

Výška přední části spotřebiče	455 mm
Výška zadní části spotřebiče	440 mm
Šířka přední části spotřebiče	595 mm
Šířka zadní části spotřebiče	559 mm
Hloubka spotřebiče	567 mm
Vestavná hloubka spotřebiče	546 mm
Hloubka s otevřenými dvířky	882 mm
Minimální velikost ventilačního otvoru. Otvor umístěný na spodní zadní straně	560x20 mm
Délka napájecího síťového kabelu. Kabel se nachází v pravém rohu zadní strany	1500 mm
Montážní šrouby	3.5x25 mm

2.2 Připojení k elektrické síti



VAROVÁNÍ!

Hrozí nebezpečí požáru nebo úrazu elektrickým proudem.

- Veškerá elektrická připojení by měla být provedena kvalifikovaným elektrikářem.
- Spotřebič musí být uzemněn.
- Zkontrolujte, zda údaje na typovém štítku souhlasí s parametry elektrické sítě.
- Vždy používejte správně instalovanou síťovou zásuvku s ochranou proti úrazu elektrickým proudem.
- Nepoužívejte rozbočovací zástrčky ani prodlužovací kabely.
- Dbejte na to, abyste nepoškodili napájecí kabel a síťovou zástrčku. Jestliže potřebujete přivodní kabel vyměnit, musí výměnu provést námi autorizované servisní středisko.
- Síťové kabely se nesmí dotýkat nebo se nacházet v blízkosti dvířek spotřebiče nebo výklenku pod spotřebičem, obzvláště je-li spotřebič v provozu nebo jsou-li dvířka horká.
- Ochrana před úrazem elektrickým proudem u živých či izolovaných částí musí být připevněna tak, aby nešla odstranit bez použití nástrojů.
- Síťovou zástrčku zapojte do síťové zásuvky až na konci instalace spotřebiče. Po instalaci musí zůstat síťová zástrčka nadále dostupná.
- Pokud je síťová zásuvka uvolněná, nezapojujte do ni síťovou zástrčku.
- Neodpojujte spotřebič ze zásuvky tahem za kabel. Vždy tahejte za zástrčku.
- Používejte pouze správná izolační zařízení: ochranné vypínače vedení, pojistky (pojistky šroubového typu se musí odstranit z držáku), ochranné zemnicí jističe a stykače.

- Je nutné instalovat vhodný vypínač nebo izolační zařízení k řádnému odpojení všech napájecích vodičů spotřebiče. Toto izolační zařízení musí mít mezeru mezi kontakty alespoň 3 mm širokou.
- Spotřebič se dodává se síťovou zástrčkou a napájecím kabelem.

2.3 Použití



VAROVÁNÍ!

Hrozí nebezpečí zranění, popálení, úrazu elektrickým proudem či výbuchu.

- Neměňte technické parametry spotřebiče.
- Ujistěte se, že větrací otvory nejsou zablokované.
- Během provozu nenechávejte spotřebič bez dozoru.
- Po každém použití spotřebič vypněte.
- Pokud je spotřebič v provozu, buďte při otevírání jeho dvířek opatrní. Může uniknout horký vzduch.
- Nepoužívejte spotřebič, máte-li vlhké ruce, nebo když je v kontaktu s vodou.
- Na otevřená dvířka netlačte.
- Nepoužívejte spotřebič jako pracovní nebo odkládací plochu.
- Dvířka spotřebiče otvírejte opatrně. Používáte-li přísady obsahující alkohol, může vzniknout směs alkoholu a vzduchu.
- Při otvírání dvířek nesmí být v blízkosti spotřebiče jiskry ani otevřený oheň.
- Do spotřebiče, do jeho blízkosti nebo na spotřebič neumísťujte hořlavé předměty nebo předměty nasáklé hořlavinami.
- Mikrovlnnou funkci nepoužívejte k předeheatí trouby.



VAROVÁNÍ!

Hrozí nebezpečí poškození spotřebiče.

- Aby nedošlo k poškození nebo změnám barvy smaltu:
 - Nepokládejte hliníkovou fólii přímo na dno vnitřku spotřebiče.
 - Nenalévejte vodu přímo do horkého spotřebiče.
 - Po dokončení přípravy jídla nenechávejte ve spotřebiči vlhké talíře ani jídlo.
 - Při vkládání nebo vyjímání příslušenství buďte opatrní.
- Barevné změny na smaltovaném povrchu nebo nerezové oceli nemají vliv na výkon spotřebiče.
- Vždy vařte se zavřenými dvířky spotřebiče.
- Je-li spotřebič instalován za nábytkovým panelem (např. dvířky), dvířka nábytku nesmí být nikdy zavřená, když je spotřebič v provozu. Za zavřeným nábytkovým panelem může docházet k nárůstu horka a vlhka, což může následně poškodit spotřebič, pouzdro nebo podlahu. Nezavírejte nábytkový panel, dokud spotřebič po použití zcela nevychladne.

2.4 Čištění a údržba



VAROVÁNÍ!

Hrozí nebezpečí poranění, požáru nebo poškození spotřebiče.

- Před čištěním nebo údržbou spotřebič vždy vypněte a vytáhněte síťovou zástrčku ze zásuvky.
- Přesvědčte se, že spotřebič už vychladl. Mohlo by dojít k prasknutí skleněných panelů.
- Poškozené skleněné panely okamžitě vyměňte. Kontaktujte autorizované servisní středisko.

BEZPEČNOSTNÍ POKYNY

- Při snímání dvířek spotřebiče buďte opatrní. Dvířka jsou těžká!
- Dbejte na to, aby vnitřek spotřebiče, otočný talíř a dvířka byly po každém použití vytřeny dosucha. Pára, která se tvoří během provozu spotřebiče, se sráží na stěnách vnitřku spotřebiče a může způsobovat korozi.
- Spotřebič čistěte pravidelně, abyste zabránili poškození materiálu jeho povrchu.
- Zbytky tuků či jídel ve spotřebiči mohou při chodu mikrovlnné funkce způsobit požár a elektrický oblouk.
- Vyčistěte spotřebič vlhkým měkkým hadrem. Používejte pouze neutrální mycí prostředky. Nepoužívejte prostředky s drsnými částicemi, drátěnky, rozpouštědla nebo kovové předměty.
- Použijete-li sprej do trouby, řiďte se bezpečnostními pokyny uvedenými na jeho balení.

2.5 Vnitřní osvětlení



VAROVÁNÍ!

Nebezpečí úrazu elektrickým proudem!

- Pokud jde o žárovku (žárovky) v tomto spotřebiči a samostatně prodávané náhradní žárovky: Tyto žárovky jsou navrženy tak, aby odolaly extrémním fyzickým podmínkám v domácích spotřebičích, ať už jde o teplotu, vibrace či vlhkost, nebo jsou určeny k signalizaci informací o provozním stavu spotřebiče. Nejsou určeny k použití v jiných spotřebičích a nejsou vhodné k osvětlení místností v domácnosti.
- Tento výrobek obsahuje světelný zdroj s třídou energetické účinnosti G.
- Používejte pouze žárovky se stejnými vlastnostmi .

2.6 Servis

- Je-li nutná oprava spotřebiče, obraťte se na autorizované servisní středisko.
- Používejte pouze originální náhradní díly.

2.7 Likvidace



VAROVÁNÍ!

Hrozí nebezpečí úrazu či udušení.

- Pro informace ohledně správné likvidace spotřebiče se obraťte na místní úřady.
- Odpojte spotřebič od elektrické sítě.
- Odřízněte síťový kabel v blízkosti spotřebiče a zlikvidujte jej.
- Odstraňte dveřní západku, abyste zabránili uvěznění dětí a domácích zvířat ve spotřebiči.

3. POPIS SPOTŘEBIČE

3.1 Celkový pohled

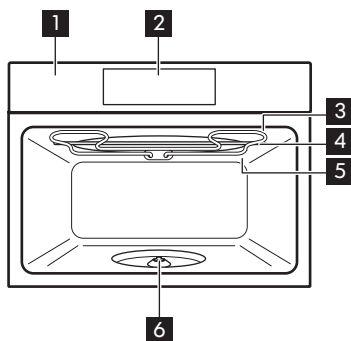

- 1** Ovládací panel
- 2** Displej
- 3** Topné těleso
- 4** Generátor mikrovln
- 5** Osvětlení

- 6** Hřídel otočného stolu

3.2 Příslušenství

Sada Turntable

K přípravě potravin.

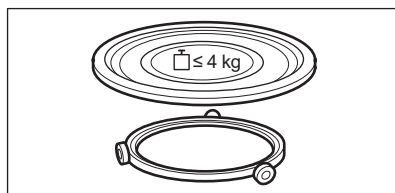

Sada grilovacího roštu

Ke grilování.

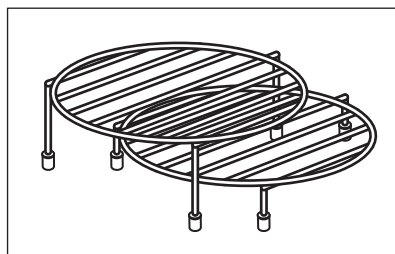

4. JAK ZAPNOUT A VYPNOUT TROUBU

4.1 Ovládací panel

JAK ZAPNOUT A VYPNOUT TROUBU

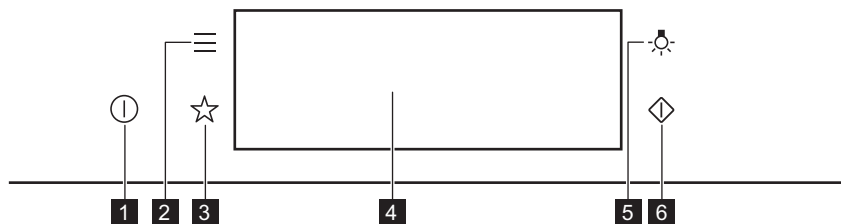



1	Zapnout / Vypnout	Stisknutím a podržením zapnete a vypnete troubu.
2	Nabídka	Zobrazí funkce trouby.
3	Oblíbené	Zobrazí oblíbená nastavení.
4	Displej	Zobrazí aktuální nastavení trouby.
5	Spínač osvětlení	Slouží k zapnutí a vypnutí osvětlení.
6	Rychlý start mikrovlnné trouby	Slouží k zapnutí mikrovlnné funkce (1 000 W a 30 sekund).

<p>Mačkejte tlačítko</p>	<p>Posuňte</p>	<p>Stiskněte a podržte</p>
Dotkněte se povrchu konečkem prstu.	Posuňte konečkem prstu po povrchu.	Dotkněte se povrchu na tři sekundy.

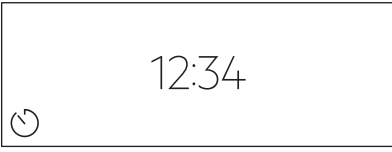

4.2 Displej

<p>The diagram shows a rectangular display area. At the top right, 'A' points to the time '12:34'. On the left, '300W' is shown above a power icon, with 'F' and 'E' below it. In the center, a grill icon is above 'High', with 'D' and 'C' below it. At the bottom right, 'START' is shown above a button icon, with 'B' below it.</p>	<p>Po zapnutí se na displeji zobrazí hlavní obrazovka s funkcí a výchozí intenzitou grilu.</p> <p>A. Denní čas B. ZAPNOUT/VYPNOUT C. Intenzita grilu D. Pečící funkce E. Mikrovlnný výkon F. Časovač</p>
--	---

	<p>Pokud troubu nepoužijete během 2 minut, displej se přepne do pohotovostního režimu.</p>
	<p>Při pečení se na displeji zobrazí nastavené a další dostupné funkce.</p>

Ukazatele na displeji

Základní ukazatele – slouží k navigaci na displeji.

<p>OK K potvrzení volby/nastavení.</p>	<p> K návratu o jednu úroveň v nabídce.</p>	<p> K vrácení posledního úkolu.</p>	<p> K zapnutí a vypnutí funkcí.</p>
---	--	--	--

Ukazatele funkce Zvukový signál – když skončí nastavený čas přípravy pokrmu, zazní zvukový signál.

<p> Funkce je zapnutá.</p>	<p> Funkce je zapnutá. Pečení se automaticky vypne.</p>	<p> Zvukový signál je vypnutý.</p>
---	--	---

Ukazatele časovače

<p> Pro nastavení funkce: Odložený start.</p>	<p> Ke zrušení nastavení.</p>
--	--

5. PŘED PRVNÍM POUŽITÍM





VAROVÁNÍ!

Viz kapitoly o bezpečnosti.

DENNÍ POUŽÍVÁNÍ

5.1 První čištění

		
Krok 1	Krok 2	Krok 3
Vyjměte z trouby všechno příslušenství.	Troubu a příslušenství otřete měkkým hadříkem, teplou vodou a šetrným mycím prostředkem.	Vložte příslušenství do trouby.

5.2 První připojení

Po prvním připojení se na displeji zobrazí uvítací zpráva.

Musíte nastavit: Jazyk, Displej jas, Tóny tlačítek, Hlasitost zv. signalizace, Denní čas.

6. DENNÍ POUŽÍVÁNÍ



VAROVÁNÍ!

Viz kapitoly o bezpečnosti.

6.1 Jak nastavit funkci: Gril + MV, Gril

Trouba může vydávat zvuky, když používáte funkci: Gril + MV. To je u této funkce běžné.

Nastavení funkce: Gril + MV	
Krok 1	Vložte spodní grilovací rošt.
Krok 2	Zapněte troubu. Na displeji se zobrazí výchozí pečicí funkce.
Krok 3	Stisknutím symbolu pečicí funkce přejděte do dílčí nabídky.
Krok 4	Zvolte funkci:  . Stiskněte: OK.
Krok 5	Zvolte úroveň intenzity grilu.
Funkce	Stupeň intenzity grilu
Lo	Nízký
Hi	Vysoký

Nastavení funkce: Gril + MV	
Krok 6	Stiskněte: OK.
Krok 7	Stiskněte: START.
STOP – stisknutím vypnete troubu.	
Krok 8	troubu vypněte.

Mikrovlnný výkon je omezen na 500 W, když použijete funkci: Gril + MV.

Nastavení funkce: Gril	
Krok 1	Vložte vysoký grilovací rošt.
Krok 2	Zapněte troubu. Na displeji se zobrazí výchozí pečicí funkce.
Krok 3	Stisknutím symbolu pečicí funkce přejděte do dílčí nabídky.
Krok 4	Zvolte funkci:  . Stiskněte: OK.
Krok 5	Zvolte úroveň intenzity grilu.
Funkce	Stupeň intenzity grilu
Lo	Nízký
Hi	Vysoký
Krok 6	Stiskněte: OK.
Krok 7	Stiskněte: START.
K vypnutí funkce stiskněte STOP.	
Krok 8	troubu vypněte.

6.2 Jak nastavit: Mikrovlnné pečicí funkce

Krok 1	Zapněte troubu.
Krok 2	Stisknutím symbolu pečicí funkce přejděte do dílčí nabídky.
Krok 3	Zvolte pečicí funkci mikrovlnné trouby a stiskněte: OK . Na displeji se zobrazí: mikrovlnný výkon.
Krok 4	Nastavte: mikrovlnný výkon. Stiskněte: OK .
Krok 5	Stiskněte: START .
K vypnutí funkce stiskněte STOP .	
Krok 6	troubu vypněte.

Maximální délka mikrovlnných funkcí závisí na nastaveném mikrovlnném výkonu:

MIKROVLNNÝ VÝKON	MAXIMÁLNÍ ČAS
100–600 W	59 minut
Více než 600 W	7 minut

 Otevřením dvířek se funkce vypne. Funkci opět spustíte stisknutím **START**.

Využijte zkratku!

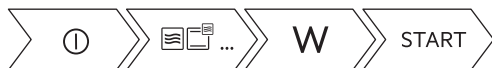



6.3 Jak použít: Rychlý start mikrovlnné trouby

Krok 1	Stiskněte a podržte:  . Mikrovlnná trouba poběží po dobu 30 sekund.	
Krok 2	K prodloužení doby přípravy:	
	Stisknutím hodnoty běžícího času přejdete na nastavení času. Nastavte dobu přípravy.	Stiskněte +30 s.





Mikrovlny lze kdykoliv zapnout pomocí Rychlý start mikrovlnné trouby.

6.4 Pečicí funkce

STANDARDNÍ

Pečicí funkce	Použití
 Gril	Ke grilování tenkých kusů potravin a opékání chleba.
 Gril + MV	K pečení pokrmů s kratší dobou přípravy a současnému opékání. Můžete nastavit 2 úrovně intenzity grilu: nízkou a vysokou.
 Mikrovlnná trouba	Ohřev, vaření, rozsah výkonu: 100–1000 W

MIKROVLNNÁ TROUBA

Pečicí funkce	Použití
 Rozmrazování	Rozmrazování masa, ryb, dortů, rozsah výkonu: 100–200 W
 Rozmrazování	Rozpouštění čokolády a másla, rozsah výkonu: 100–400 W
 Ohřívání	Ohřev hotových pokrmů a choulostivých potravin, rozsah výkonu: 300–700 W
 Popcorn	Příprava popcornu, rozsahu výkonu: 700–1000 W

FUNKCE HODIN

Pečicí funkce	Použití
 Tekutina	Ohřev nápojů a polévek, rozsah výkonu: 800–1000 W

7. FUNKCE HODIN

7.1 Popis funkcí hodin

Funkce hodiny	Použití
Čas pečení	K nastavení délky přípravy jídla. Maximum je 23 h 59 min.
Ukončit akci	K nastavení toho, co se stane po dokončení počítání časovače.
Prodloužení doby pečení	K prodloužení doby přípravy.
Připomínka	K nastavení odpočítávání času. Maximum je 23 h 59 minut. Tato funkce nemá žádný vliv na provoz trouby.
Časovač	Kontroluje, jak dlouho je tato funkce v provozu. Časovač – můžete jej zapnout a vypnout.

7.2 Jak nastavit: Funkce hodin

Jak nastavit hodiny	
Krok 1	Stiskněte: Denní čas.
Krok 2	Nastavte čas. Stiskněte: OK.

Jak nastavit dobu přípravy	
Krok 1	Zvolte pečicí funkci.
Krok 2	Stiskněte:  .
Krok 3	Nastavte čas. Stiskněte: OK.

Jak zvolit funkci ukončení	
Krok 1	Zvolte pečicí funkci.
Krok 2	Stiskněte:  .
Krok 3	Nastavte dobu přípravy.
Krok 4	Stiskněte: ● ● ● .
Krok 5	Stiskněte: Ukončit akci.
Krok 6	Zvolte upřednostňované: Ukončit akci.
Krok 7	Stiskněte: OK. Opakujte, dokud se na displeji nezobrazí hlavní obrazovka.

Jak prodloužit dobu přípravy
Když zbývá 10 % doby přípravy a jídlo se nezdá být hotové, můžete prodloužit dobu přípravy. Také můžete změnit pečicí funkci.
Stisknutím +1min prodloužíte dobu přípravy.

Jak změnit nastavení časovače	
Krok 1	Stiskněte:  .
Krok 2	Nastavte hodnotu časovače.
Krok 3	Stiskněte: OK.
Nastavený čas lze změnit kdykoliv během přípravy jídla.	

8. POUŽITÍ: PŘÍSLUŠENSTVÍ

8.1 Vkládání příslušenství

Používejte výhradně vhodné nádoby a materiály. Viz kapitola „Tipy a rady“, Nádoby a materiály vhodné k použití v mikrovlnné troubě.

DOPLŇKOVÉ FUNKCE

Sada Turntable:

Vždy připravujte jídlo na soupravě otočného talíře.

Vodící lištu válečků nasadte kolem hřídele otočného talíře. Skleněný otočný talíř položte na vodící lištu válečků.

Používejte pouze soupravu otočného talíře dodávanou s troubou.

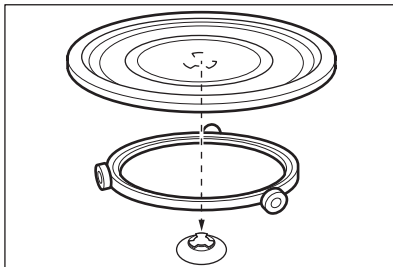

Sada grilovacího roštu:

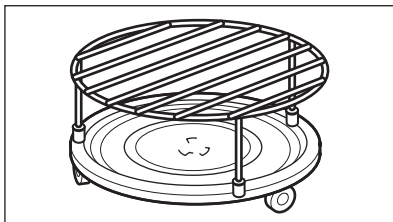

Vložte grilovací rošt na soupravu otočného talíře silikonovými krytkami dolů.



9. DOPLŇKOVÉ FUNKCE



9.1 Jak uložit: Oblíbené

Můžete ukládat svá oblíbená nastavení, jako např. pečicí funkci, dobu pečení nebo čisticí funkci. Můžete uložit tři oblíbená nastavení.

Krok 1	Zapněte troubu.
Krok 2	Zvolte upřednostňované nastavení.
Krok 3	Stiskněte:  . Zvolte: Oblíbené.
Krok 4	Vyberte: Uložit aktuální nastavení.
Krok 5	Stisknutím + přidáte nastavení do seznamu: Oblíbené. Stiskněte tlačítko OK.
	– stisknutím resetujete nastavení.
	– stisknutím zrušíte nastavení.

9.2 Blokování tlačítek

Tato funkce brání náhodné změně pečicí funkce.

Krok 1	Zapněte troubu.
Krok 2	Nastavte pečicí funkci.
Krok 3	Současným stisknutím  a  zapněte funkci.
K vypnutí funkce zopakujte krok 3.	

9.3 Chladicí ventilátor

Když je trouba v provozu, chladicí ventilátor se automaticky zapne, aby udržoval povrch trouby chladný. Jestliže troubu vypnete, bude chladicí ventilátor pokračovat v chlazení až do úplného ochlazení trouby.

10. TIPY A RADY

10.1 Doporučení k pečení

<p>Teploty a časy přípravy v tabulkách jsou pouze orientační. Závisí na receptu, kvalitě a množství použitých přísad.</p> <p>Vaše trouba může péct jinak, než jak jste byli zvyklí u staré trouby. Níže uvedené rady představují doporučené pečicí funkce a nastavení délky přípravy pro specifické druhy pokrmů.</p> <p>Jestliže nemůžete najít nastavení pro konkrétní recept, snažte se vybrat podobný.</p> <p>Více doporučení ohledně vaření naleznete v tabulkách vaření na naší webové stránce. Tipy pro vaření naleznete pomocí výrobního čísla PNC, které je uvedeno na typovém štítku na předním rámu vnitřku trouby.</p>

10.2 Doporučení k mikrovlnné troubě

Pojdme vařit!

Pokrm neumísťujte přímo na otočný talíř. Vždy používejte nádoby vhodné pro mikrovlnnou troubu.

Varnou nádobu postavte do středu otočného talíře.

Přijde-li otočný talíř do kontaktu s příliš horkými nebo příliš studenými předměty, může prasknout.

V polovině doby rozmrazování a pečení jídlo otočte nebo zamíchejte.

Tekuté pokrmy čas od času zamíchejte.

Před servírováním jídlo zamíchejte.

Jídlo při pečení i opakovaném ohřevu zakrývejte.

Vložte-li do lahve nebo sklenice lžici, teplo se při ohřevu nápojů lépe rozvede.

Jídlo vložte do trouby bez obalu. Balená hotová jídla lze do trouby vložit pouze tehdy, pokud lze obal bezpečně použít v mikrovlnné troubě (zkontrolujte údaje na obalu).



Příprava pokrmů v mikrovlnné troubě

Jídlo připravujte zakryté. Chcete-li uchovat kůrčičku, připravujte pokrm nezakrytý.

Nepřevařte potraviny nastavením příliš vysokého výkonu a příliš dlouhého času. Potraviny by mohly vyschnout, spálit se nebo způsobit požár.

V troubě nepřipravujte vejce ve skořápkách a šneky, protože mohou prasknout. Před opětovným ohřevem smaženého vejce propíchněte žloutek.

Potraviny se slupkou před vařením několikrát propíchněte.

Zeleninu rozřízněte na podobně velké kusy.

Po vypnutí trouby jídlo vyjměte a nechte ho několik minut odstát, aby se teplo rovnoměrně rozvedlo.



Rozmrazování v mikrovlnné troubě

Rozbalené zmražené potraviny umístěte na malý obrácený talíř pod který vložíte nádobku nebo na rozmrazovací rošt či plastové síto, aby při rozmrazování mohla odtékat tekutina.





Rozmrazené kousky následně odeberte.





Chcete-li ovoce a zeleninu vařit, aniž byste je rozmrazili, můžete použít vyšší mikrovlnný výkon.

10.3 Nádobí a materiály vhodné do mikrovlnné trouby

V mikrovlnné troubě používejte výhradně vhodné nádobí a materiály. Řiďte se údaji v tabulce níže.



Před použitím ověřte technické údaje nádobí/materiálu.







Nádobí/materiál				
Žáruvzdorné sklo a porcelán bez kovových dílů	✓	✓	✓	✓
Nežáruvzdorné sklo a porcelán bez stříbrných, zlatých, platinových nebo jiných kovových dekorací	✓	X	X	X
Sklo a sklokeramika z ohnivzdorného a mrazuvzdorného materiálu	✓	✓	✓	✓
Keramika a kamenina bez skleněných nebo kovových částí a bez glazury s obsahem kovu	✓	✓	X	X
Keramika, porcelán a kamenina s neglazovaným dnem nebo s malými dírkami, např. na rukojetích	X	X	X	X
Plast, žáruvzdorný do 200 °C	✓	✓	X	X



Nádobi/materiál				
Karton, papír	✓	X	X	X
Potravinová fólie	✓	X	X	X
Fólie na pečení s uzávěrem vhodným pro mikrovlnnou troubu	✓	✓	X	X
Pečicí nádoby vyrobené z kovu, např. smalt, litina	X	X	✓	X
Formy na pečení, černě lakované nebo se silikonovou vrstvou	X	X	✓	X
Nádoby do mikrovlnné trouby, například pražičí pánvička	X	✓	X	X
Sada grilovacího roštu	X	X	✓	✓





10.4 Doporučená nastavení výkonu pro různé druhy pokrmů

Údaje v tabulce jsou pouze orientační.

800–1000 W	
 Osmažení na začátku přípravy jídla	 Ohřev tekutin

500–700 W					
 Příprava zeleniny	 Vaření pokrmů z vajec	 Pomalou dušené pokrmy	 Dušení rýže	 Ohřívání jídel na jeden talíř	 Rozmrazování a ohřívání mražených jídel





300–400 W		
 Rozpouštění sýrů, čokolády, másla	 Vaření/ohřívání choulostivých potravin	 Další vaření

100–200 W				
 Ohřívání dětské výživy	 Rozmrazování chleba	 Rozmrazování ovoce a koláčů	 Rozmrazování sýrů, smetany, másla	 Rozmrazování masa, ryb





10.5 Tabulky vaření pro zkušebny

Informace pro zkušebny

Testy podle normy IEC 60705.

MIKROVLNNÁ FUNKCE	 POWER (W)	 (kg)		 (min.)	
Piškotový koláč	600	0.475	Souprava otočného talíře	5 - 7	-
Sekaná	500	0.9	Sada Turntable	18 - 20	-
Vaječný krém	500	1	Souprava otočného talíře	15 - 17	-
Rozmrazování masa	200	0.5	Souprava otočného talíře	8 - 9	-

**Použijte funkci: Mikrovlnný gril.
Použijte spodní grilovací rošť.**

KOMBINOVANÁ MIKROVLNNÁ FUNKCE	 POWER (W)	 Stupeň intenzity grilu	 (min.)	
Zapečené brambory, 1,1 kg	300	nizký	30 - 35	-
Kuře, 1,1 kg	300	vysoký	30 - 35	Vložte maso do kulaté skleněné nádoby.

11. ČIŠTĚNÍ A ÚDRŽBA



VAROVÁNÍ!

Viz kapitoly o bezpečnosti.

11.1 Poznámky k čištění



Čistící prostředky

Přední stranu trouby otřete měkkým hadříkem namočeným v roztoku teplé vody a šetrného mycího prostředku.

Kovové plochy očistěte pomocí čistícího roztoku.

Skvrny vyčistěte pomocí šetrného čistícího prostředku.



Každodenní použití

Vnitřek trouby očistěte po každém použití. Hromadění mastnoty či zbytků jídel může způsobit požár.
Strop vnitřku trouby důkladně očistěte od zbytků jídla a mastnoty.

Neuchovávejte potraviny v troubě déle než 20 minut. Osušte vnitřek měkkým hadrem po každém použití.

ODSTRAŇOVÁNÍ ZÁVAD

	Vyčistěte všechno příslušenství po každém použití a nechte jej vysušit. Před čištěním vyčkejte, dokud otočný talíř nevychladne. Mohlo by dojít k prasknutí otočného talíře. Použijte měkký hadr a vlažnou vodu s šetrným mycím prostředkem. Nečistěte příslušenství v myčce nádobí
	Příslušenství Nepřilnavé příslušenství nečistěte pomocí abrazivních čisticích prostředků nebo ostrých předmětů.



12. ODSTRAŇOVÁNÍ ZÁVAD





VAROVÁNÍ!

Viz kapitoly o bezpečnosti.



12.1 Co dělat, když...

 Trouba se nezapne nebo se neohřívá	
 Možná příčina	 Řešení
Trouba není zapojená do elektrické sítě nebo je zapojená nesprávně.	Zkontrolujte, zda je trouba správně zapojena do elektrické sítě.
Hodiny nejsou nastavené.	Nastavte hodiny. Instrukce naleznete v kapitole „Funkce hodin“ v části Jak nastavit: Funkce hodin.
Dvířka nejsou správně zavřená.	Zcela zavřete dvířka.
Je spálená pojistka.	Zkontrolujte, zda není příčinou závady pojistka. Pokud problém přetrvává, obraťte se na kvalifikovaného elektrikáře.
Dětská bezpečnostní pojistka trouby je zapnutá.	Viz kapitola „Nabídka“, podnabídka pro: Funkce.

 Součásti	
 Popis	 Řešení
Spálená žárovka.	Vyměňte žárovku. Podrobnosti naleznete v kapitole „Čištění a údržba“ v části Jak vyměnit: Osvětlení.
Otočný talíř je hlučný.	Pod soupravou otočného talíře jsou zbytky jídla.

12.2 Jak spravovat: Chybové kódy

Když dojde k chybě software, na displeji se zobrazí chybová zpráva. V této části naleznete seznam problémů, které můžete zvládnout sami.

 Kód a popis	 Řešení
F240, F439 - dotyková tlačítka na displeji nefungují správně.	Vyčistěte povrch displeje. Ujistěte se, že na dotykových políčkách nejsou nečistoty.
F908 - systém trouby se nemohl připojit k ovládacímu panelu.	Troubu vypněte a zapněte.

12.3 Servisní údaje

Pokud problém nemůžete vyřešit sami, obraťte se na svého prodejce nebo autorizované servisní středisko.

Potřebné údaje pro servisní středisko najdete na typovém štítku. Typový štítek se nachází na předním rámu vnitřku trouby. Nesundávejte typový štítek z vnitřní části trouby.

Doporučujeme vám zapsat si údaje sem:	
Model (Mod.)
Výrobní číslo (PNC)
Sériové číslo (S.N.)

13. ENERGETICKÁ ÚČINNOST

13.1 Úspora energie



Trouba je vybavena funkcemi, které vám pomohou ušetřit energii při každodenním pečení.

Při provozu spotřebiče se přesvědčte, že jsou dvířka trouby zavřena. Během pečení neotvírejte dvířka trouby příliš často. Těsnění dvířek udržujte čisté a kontrolujte, zda je na svém místě řádně uchyceno.

Je-li to možné, troubu před pečením nepřehřívejte.

Připravujete-li několik jídel najednou, snažte se, aby prodlevy při pečení byly co nejkratší.

Pečení s vypnutým osvětlením

Při pečení vypněte osvětlení. Zapněte ho pouze tehdy, když ho skutečně potřebujete.

14. STRUKTURA NABÍDKY

14.1 Nabídka

Stisknutím otevřete Nabídka.

Položka nabídky		Použití
Oblíbené		Zobrazí oblíbená nastavení.
Funkce		K nastavení konfigurace trouby.
Nastavení	Nastavení	K nastavení konfigurace trouby.
	Obsluha	Zobrazuje verzi software a konfiguraci.

14.2 Dílčí nabídka pro: Funkce

Dílčí nabídka	Použití
Osvětlení	Slouží k zapnutí a vypnutí osvětlení.
Dětská bezp. pojistka	Brání náhodnému zapnutí trouby. Když je tato funkce zapnutá, na displeji se po zapnutí trouby zobrazí text „Dětská bezp. pojistka“. Abyste mohli troubu používat, zvolte písmeno kódu v abecedním pořadí. Přístup k časovači, dálkovému ovládání a osvětlení je možné provést pomocí se zapnutou dětskou bezpečnostní pojistkou.
Časové údaje	Slouží k zapnutí a vypnutí hodin.

Dílčí nabídka	Použití
Formát digitálních hodin	Slouží ke změně formátu zobrazování časových údajů.

14.3 Dílčí nabídka pro: Nastavení

Dílčí nabídka	Popis
Jazyk	K nastavení jazyka trouby.
Displej jas	K nastavení jasu displeje.
Tóny tlačítek	K zapnutí a vypnutí tónů dotykových políček. Ozvučení nelze vypnout u:  .
Hlasitost zv. signalizace	K nastavení hlasitosti tónů tlačítek a signalizace.
Denní čas	K nastavení aktuálního času a data.

14.4 Podnabídka pro: Obsluha





Podnabídka	Popis
Režim demo	Aktivační / deaktivací kód: 2468
Verze software	Informace o verzi softwaru.
Zrušit všechna nastavení	K obnovení továrního nastavení.

15. JE TO SNADNÉ!

Před prvním použitím musíte nastavit:				
Jazyk	Displej jas	Tóny tlačítek	Hlasitost zv. signalizace	Denní čas





JE TO SNADNÉ!

Seznamte se se základními symboly na ovládacím panelu a displeji:

 Zapnout / Vypnout	 Nabídka	 Oblíbené	 Časovač	START / STOP
--	--	---	--	--------------



Zahájení používání trouby

Rychlé spuštění MV	Mikrovlnnou troubu můžete kdykoliv spustit s výchozím nastavením: 30 s / 1000 W.	Stiskněte:  .
---------------------------	--	--

			
ohřev/pečení 100–1000 W	pečení/opékání intenzita: nízká/vysoká	pečení/opékání	ohřev tekutin 800–1000 W
			
opakovaný ohřev 300–700 W	rozmrazování 100–200 W	rozpouštění 100–400 W	příprava popcornu 700–1000 W

Nastavení mikrovlnné trouby		Tipy pro mikrovlnnou troubu
Mikrovlnný výkon:	Maximální čas:	Jídlo při pečení i opakovaném ohřevu zakryvejte. V polovině doby rozmrazování a pečení jídlo otočte nebo zamíchejte. Do nádobí při ohřevu tekutin vložte lžičku. Vložte jídlo do trouby bez obalu (není-li určen pro použití v mikrovlnné troubě).
100–600 W	59 min.	
>600 W	7 min.	

Zahájení vaření

Krok 1	Krok 2	Krok 3	Krok 4	Krok 5
 – stisknutím zapněte troubu.	 ... – zvolte funkci.	W – nastavte mikrovlnný výkon.	OK – potvrďte stisknutím.	START – stisknutím spustíte vaření.



K nastavení doby přípravy použijte rychlé funkce.

Podpora dokončení přípravy při 10 %

Když zbývá jen 10 % doby přípravy, použijte možnost Podpora dokončení přípravy při 10 %, která přidá dodatečný čas.

Stisknutím **+1min** prodloužíte dobu přípravy.

16. POZNÁMKY K OCHRANĚ ŽIVOTNÍHO PROSTŘEDÍ

Recyklujte materiály označené symbolem . Obaly vyhodte do příslušných odpadních kontejnerů k recyklaci. Pomáhejte chránit životní prostředí a lidské zdraví a recyklovat elektrické a elektronické spotřebiče určené k likvidaci. Spotřebiče označené příslušným symbolem  nelikvidujte spolu s domovním odpadem. Spotřebič odevzdejte v místním sběrném dvoře nebo kontaktujte místní úřad.

FÜR PERFEKTE ERGEBNISSE

Danke, dass Sie sich für dieses AEG Produkt entschieden haben. Wir haben es geschaffen, damit Sie viele Jahre von seiner ausgezeichneten Leistung und den innovativen Technologien, die Ihnen das Leben erleichtern, profitieren können. Es ist mit Funktionen ausgestattet, die in gewöhnlichen Geräten nicht vorhanden sind. Bitte nehmen Sie sich ein paar Minuten Zeit, um das Beste aus ihm herauszuholen.

Besuchen Sie uns auf unserer Website, um:



Anwendungshinweise, Prospekte, Informationen zu Fehlerbehebung, Service und Reparatur zu erhalten:

www.aeg.com/support



Registrieren Sie Ihr Produkt, um einen erstklassigen Service zu erhalten:

www.registreaeg.com



Um Zubehör, Verbrauchsmaterial und Original-Ersatzteile für Ihr Gerät zu kaufen:

www.aeg.com/shop

KUNDENDIENST UND SERVICE

Verwenden Sie immer Original-Ersatzteile.

Halten Sie folgende Angaben bereit, wenn Sie sich an einen autorisierten Kundendienst wenden: Modell, PNC, Seriennummer.

Die Daten finden Sie auf dem Typenschild.

 Warnungs-/Sicherheitshinweise

 Allgemeine Informationen und Empfehlungen

 Informationen zum Umweltschutz

Änderungen vorbehalten.

INHALTSVERZEICHNIS

1. SICHERHEITSHINWEISE.....	63	3. GERÄTEBESCHREIBUNG.....	70
1.1 Sicherheit von Kindern und schutzbedürftigen Personen.....	63	3.1 Gesamtansicht.....	70
1.2 Allgemeine Sicherheit.....	64	3.2 Zubehör.....	71
2. SICHERHEITSANWEISUNGEN.....	67	4. EIN- UND AUSSCHALTEN DES BACKOFENS.....	71
2.1 Montage.....	67	4.1 Bedienfeld.....	71
2.2 Elektrischer Anschluss.....	68	4.2 Display.....	72
2.3 Gebrauch.....	68	5. VOR DER ERSTEN VERWENDUNG.....	73
2.4 Reinigung und Pflege.....	69	5.1 Erste Reinigung	73
2.5 Innenbeleuchtung.....	70	5.2 Erste Verbindung.....	73
2.6 Wartung.....	70		
2.7 Entsorgung.....	70		

6. TÄGLICHER GEBRAUCH.....	74	10.4 Empfohlene Leistungseinstellungen für verschiedene Arten von Lebensmitteln.....	84
6.1 So stellen Sie die Funktion ein: Grill + MW, Grill.....	74	10.5 Gartabellen für Prüfinstitute.....	84
6.2 Einstellung: Mikrowellengarfunktionen.....	75	11. REINIGUNG UND PFLEGE.....	85
6.3 Benutzung: Mikrowellen-Schnellstart.....	76	11.1 Hinweise zur Reinigung.....	86
6.4 Ofenfunktionen.....	76	12. FEHLERSUCHE.....	86
7. UHRFUNKTIONEN.....	78	12.1 Was zu tun ist, wenn 86	
7.1 Beschreibung der Uhrfunktionen... 78		12.2 Handhabung: Fehlercodes..... 87	
7.2 Einstellung: Uhrfunktionen..... 78		12.3 Servicedaten..... 88	
8. VERWENDUNG: ZUBEHÖR.....	80	13. ENERGIEEFFIZIENZ.....	88
8.1 Einsetzen des Zubehörs..... 80		13.1 Energiesparen..... 88	
9. ZUSATZFUNKTIONEN.....	80	14. MENÜSTRUKTUR.....	88
9.1 So speichern Sie: Favoriten..... 80		14.1 Menü..... 88	
9.2 Tastensperre..... 81		14.2 Untermenü für: Optionen..... 89	
9.3 Kühlgebläse..... 81		14.3 Untermenü für: Setup..... 89	
10. TIPPS UND HINWEISE.....	81	14.4 Untermenü von: Service..... 90	
10.1 Garempfehlungen..... 81		15. DAS IST GANZ EINFACH!.....	90
10.2 Mikrowellenempfehlungen 81		16. UMWELTTIPPS.....	91
10.3 Mikrowellengeeignetes Kochgeschirr und Materialien 82			

1. SICHERHEITSHINWEISE

Lesen Sie vor der Montage und dem Gebrauch des Geräts zuerst die Bedienungsanleitung. Bei Verletzungen oder Schäden infolge nicht ordnungsgemäßer Montage oder Verwendung übernimmt der Hersteller keine Haftung. Bewahren Sie die Anleitung zum Nachschlagen an einem sicheren und zugänglichen Ort auf.

1.1 Sicherheit von Kindern und schutzbedürftigen Personen

- Das Gerät kann von Kindern ab 8 Jahren und Personen mit eingeschränkten physischen, sensorischen oder geistigen Fähigkeiten oder mit mangelnder Erfahrung/mangelndem Wissen benutzt werden, wenn sie durch eine für ihre Sicherheit zuständige Person beaufsichtigt werden oder von

dieser Person Anweisungen erhalten haben, wie das Gerät sicher zu bedienen ist und welche Gefahren bei nicht ordnungsgemäßer Bedienung bestehen. Kinder unter 8 Jahren und Personen mit schweren Behinderungen oder Mehrfachbehinderung sollten vom Gerät ferngehalten werden, wenn sie nicht ständig beaufsichtigt werden.

- Kinder sollten beaufsichtigt werden, um sicherzustellen, dass sie nicht mit dem Gerät.
- Halten Sie sämtliches Verpackungsmaterial von Kindern fern und entsorgen Sie es ordnungsgemäß.
- **WARNUNG:** Halten Sie Kinder und Haustiere von dem Gerät fern, wenn es in Betrieb oder in der Abkühlphase ist. Die zugänglichen Geräteteile werden beim Betrieb sehr heiß.
- Falls Ihr Gerät mit einer Kindersicherung ausgestattet ist, empfehlen wir, diese einzuschalten.
- Kinder dürfen keine Reinigung und Wartung des Geräts ohne Beaufsichtigung durchführen.

1.2 Allgemeine Sicherheit

- Dieses Gerät ist nur zum Kochen bestimmt.
- Dieses Gerät ist für den Hausgebrauch in einem Einfamilienhaus in Innenräumen bestimmt.
- Dieses Gerät darf in Büros, Hotelzimmern, Gästezimmern in Pensionen, Bauernhöfen und anderen ähnlichen Unterkünften verwendet werden, wenn diese Nutzung das (durchschnittliche) Nutzungsniveau im Haushalt nicht überschreitet.
- Die Montage des Geräts und der Austausch des Kabels muss von einer Fachkraft vorgenommen werden.
- Verwenden Sie das Gerät nicht, bevor es in den Einbauschrank gesetzt wird.
- Vor Wartungsarbeiten ist das Gerät von der elektrischen Stromversorgung zu trennen.

- Wenn das Netzkabel beschädigt ist, muss es vom Hersteller, seinem autorisierten Kundenservice oder einer gleichermaßen qualifizierten Person ausgetauscht werden, um Gefahren durch elektrischen Strom zu vermeiden.
- **WARNUNG:** Vergewissern Sie sich, dass das Gerät ausgeschaltet ist, bevor Sie die Lampe austauschen, um einen Stromschlag zu vermeiden.
- **WARNUNG:** Das Gerät und die zugänglichen Geräteteile werden während des Betriebs heiß. Seien Sie vorsichtig und berühren Sie niemals die Heizelemente.
- Verwenden Sie stets Topfhandschuhe, um Zubehör oder Geschirr zu herauszunehmen oder zu verstauen.
- Verwenden Sie stets nur den für dieses Gerät vorgesehenen Drehteller und den Drehtellerträger.
- Schalten Sie die Mikrowellenfunktion nicht ein, wenn das Gerät leer ist. Metallteile im Garraum können einen Lichtbogen erzeugen.
- Verwenden Sie beim Garen in der Mikrowelle keine Metallbehälter für Speisen und Getränke. Diese Vorgabe gilt nicht, wenn der Hersteller Angaben zur Größe und Form der Metallbehälter, die geeignet für das Garen in der Mikrowelle sind, zur Verfügung gestellt hat.
- **WARNUNG:** Wenn die Tür oder Türdichtungen beschädigt sind, darf das Gerät erst wieder in Betrieb genommen werden, wenn es von einer Fachkraft repariert wurde.
- **WARNUNG:** Nur eine qualifizierte Fachkraft darf Wartungs- oder Reparaturarbeiten ausführen, die Entfernung einer Abdeckung beinhalten, die Schutz vor der Mikrowellenenergie bietet.
- **WARNUNG:** Erhitzen Sie keine Flüssigkeiten und andere Lebensmittel in geschlossenen Behältern. Sie können explodieren.
- Verwenden Sie nur mikrowellengeeignetes Kochgeschirr.

- Wenn Sie Lebensmittel in Behältern aus Kunststoff oder Papier erwärmen, beobachten Sie das Gerät aufmerksam, da die Möglichkeit einer Entflammung besteht.
- Das Gerät ist zum Erhitzen von Speisen und Getränken bestimmt. Das Trocknen von Lebensmitteln oder Kleidungsstücken und das Erhitzen von Wärmekissen, Hausschuhen, Schwämmen, feuchten Tüchern und Ähnlichem kann zu Verletzungen, Entzündungen oder Bränden führen.
- Wenn Rauch austritt, schalten Sie das Gerät aus oder ziehen Sie den Netzstecker aus der Steckdose und halten Sie die Tür geschlossen, um Flammen zu ersticken.
- Das Erhitzen von Getränken in der Mikrowelle kann zu einem verzögerten Überkochen führen. Seien Sie beim Umgang mit dem Behälter vorsichtig.
- Der Inhalt von Trinkflaschen und Gläsern mit Babynahrung muss vor dem Verzehr umgerührt oder geschüttelt und die Temperatur geprüft werden, um Verbrennungen zu vermeiden.
- Eier mit Schale und ganze, hart gekochte Eier dürfen nicht im Gerät erhitzt werden, da sie explodieren können, auch nachdem die Erhitzung in der Mikrowelle beendet ist.
- Das Gerät muss regelmäßig gereinigt und alle Speisereste entfernt werden.
- Reinigen Sie das Gerät nicht mit einem Dampfstrahlreiniger.
- Benutzen Sie zum Reinigen der Glastür keine scharfen Scheuermittel oder Metallschwämmchen; sie könnten die Glasfläche verkratzen und zum Zersplittern der Scheibe führen.
- Wird das Gerät nicht in einem sauberen Zustand gehalten, kann dies zu einer Verschlechterung der Oberfläche führen, die sich negativ auf die Lebensdauer des Geräts auswirkt und möglicherweise zu einer gefährlichen Situation führen kann.

2. SICHERHEITSANWEISUNGEN

2.1 Montage



WARNUNG!

Die Montage des Geräts darf nur von einer qualifizierten Fachkraft durchgeführt werden.

- Entfernen Sie das gesamte Verpackungsmaterial.
- Montieren Sie ein beschädigtes Gerät nicht und benutzen Sie es nicht.
- Halten Sie sich an die mitgelieferte Montageanleitung.
- Seien Sie beim Umsetzen des Gerätes vorsichtig, da es sehr schwer ist. Tragen Sie stets Sicherheitshandschuhe und festes Schuhwerk.
- Ziehen Sie das Gerät nicht am Griff.
- Montieren Sie das Gerät an einem sicheren und geeigneten Ort, der den Montageanforderungen entspricht.
- Die Mindestabstände zu anderen Geräten und Küchenmöbeln sind einzuhalten.
- Überprüfen Sie vor der Montage des Gerätes, ob sich die Ofentür ohne Kraftanwendung öffnen lässt.
- Das Gerät ist mit einem elektrischen Kühlsystem ausgestattet. Es muss mit der elektrischen Stromversorgung betrieben werden.
- Das Einbaugerät muss die Stabilitätsanforderungen von DIN 68930 erfüllen.

Mindesthöhe des Einbaumöbels (Mindesthöhe des Schanks unter der Arbeitsplatte)	444 (460) mm
Schrankbreite	560 mm
Schrantiefe	550 (550) mm
Höhe der Gerätevorderseite	455 mm
Höhe der Geräterückseite	440 mm
Breite der Gerätevorderseite	595 mm
Breite der Geräterückseite	559 mm
Gerätetiefe	567 mm
Geräteeinbautiefe	546 mm
Tiefe bei geöffneter Tür	882 mm
Mindestgröße der Belüftungsöffnung. Öffnung auf der Rückseite unten	560x20 mm

SICHERHEITSANWEISUNGEN

Länge des Netzanschlusskabels. Das Kabel befindet sich in der rechten Ecke auf der Rückseite	1500 mm
Befestigungsschrauben	3.5x25 mm

2.2 Elektrischer Anschluss



WARNUNG!

Brand- und Stromschlaggefahr.

- Alle elektrischen Anschlüsse sind von einem geprüften Elektriker vorzunehmen.
- Das Gerät muss geerdet sein.
- Stellen Sie sicher, dass die Daten auf dem Typenschild mit den elektrischen Nennwerten der Netzspannung übereinstimmen.
- Schließen Sie das Gerät nur an eine ordnungsgemäß installierte Schutzkontaktsteckdose an.
- Verwenden Sie keine Mehrfachsteckdosen oder Verlängerungskabel.
- Achten Sie darauf, Netzstecker und Netzkabel nicht zu beschädigen. Falls das Netzkabel des Geräts ersetzt werden muss, lassen Sie diese Arbeit durch unseren autorisierten Kundendienst durchführen.
- Achten Sie darauf, dass das Netzkabel die Gerätetür oder die Nische unter dem Gerät nicht berührt oder in ihre Nähe gelangt, insbesondere wenn das Gerät eingeschaltet oder die Tür heiß ist.
- Alle Teile, die gegen direktes Berühren schützen, sowie die isolierten Teile müssen so befestigt werden, dass sie nicht ohne Werkzeug entfernt werden können.
- Stecken Sie den Netzstecker erst nach Abschluss der Montage in die Steckdose. Stellen Sie sicher, dass der Netzstecker nach der Montage noch zugänglich ist.
- Falls die Steckdose lose ist, schließen Sie den Netzstecker nicht an.
- Ziehen Sie nicht am Netzkabel, wenn Sie das Gerät von der Stromversorgung trennen möchten. Ziehen Sie stets am Netzstecker.
- Verwenden Sie nur geeignete Trenneinrichtungen: Überlastschalter, Sicherungen (Schraubsicherungen müssen aus dem Halter entfernt werden können), Fehlerstromschutzschalter und Schütze.
- Die elektrische Installation muss eine Trenneinrichtung aufweisen, mit der Sie das Gerät allpolig von der Stromversorgung trennen können. Die Trenneinrichtung muss mit einer Kontaktöffnungsweite von mindestens 3 mm ausgeführt sein.
- Das Gerät wird mit einem Netzstecker und Netzkabel geliefert.

2.3 Gebrauch



WARNUNG!

Verletzungs-, Verbrennungs-, Stromschlag- oder Explosionsgefahr.

- Nehmen Sie keine technischen Änderungen am Gerät vor.
- Vergewissern Sie sich, dass die Lüftungsöffnungen nicht blockiert sind.
- Lassen Sie das Gerät während des Betriebs nicht unbeaufsichtigt.
- Schalten Sie das Gerät nach jedem Gebrauch aus.
- Gehen Sie beim Öffnen der Tür vorsichtig vor, wenn das Gerät in Betrieb ist. Es kann heiße Luft freigesetzt werden.

- Benutzen Sie das Gerät nicht mit nassen Händen oder wenn es mit Wasser Kontakt hat.
- Üben Sie keinen Druck auf die offene Tür aus.
- Verwenden Sie das Gerät nicht als Arbeits- oder Abstellfläche.
- Öffnen Sie die Gerätetür vorsichtig. Die Verwendung von Zutaten mit Alkohol kann eine Mischung aus Alkohol und Luft verursachen.
- Lassen Sie beim Öffnen der Tür keine Funken oder offenen Flammen mit dem Gerät in Kontakt kommen.
- Platzieren Sie keine entflammaren Produkte oder Gegenstände, die mit entflammaren Produkten benetzt sind, im Gerät, auf dem Gerät oder in der Nähe des Geräts.
- Heizen Sie den Backofen nicht mit der Mikrowellenfunktion vor.



WARNUNG!

Risiko von Schäden am Gerät.

- Um Beschädigungen und Verfärbungen der Emailbeschichtung zu vermeiden:
 - Legen Sie keine Alufolie direkt auf den Boden des Garraums.
 - Füllen Sie kein Wasser in das heiße Gerät.
 - Lassen Sie nach Abschluss des Garvorgangs kein feuchtes Geschirr oder feuchte Speisen im Gerät stehen.
 - Gehen Sie beim Herausnehmen oder Einsetzen des Zubehörs sorgfältig vor.
- Verfärbungen der Emaille- oder Edelstahlbeschichtung haben keine Auswirkung auf die Leistung des Geräts.
- Kochen Sie immer bei geschlossener Gerätetür.
- Ist das Gerät hinter einer Möbelfront (wie etwa einer Tür) installiert, achten Sie darauf, dass die Tür während des Gerätebetriebs nicht geschlossen wird. Hinter einer geschlossenen Möbelfront können sich Hitze und Feuchtigkeit ansammeln und das Gerät, das Gehäuse oder den Boden beschädigen. Schließen Sie die Möbelfront nicht, bevor das Gerät nach dem Gebrauch völlig abgekühlt ist.

2.4 Reinigung und Pflege



WARNUNG!

Verletzungs-, Brandgefahr sowie Risiko von Schäden am Gerät.

- Schalten Sie das Gerät immer aus und ziehen Sie den Netzstecker aus der Steckdose, bevor Reinigungsarbeiten durchgeführt werden.
- Vergewissern Sie sich, dass das Gerät abgekühlt ist. Es besteht die Gefahr, dass die Glasscheiben brechen.
- Ersetzen Sie die Türglasscheiben umgehend, wenn sie beschädigt sind. Wenden Sie sich an einen autorisierten Kundendienst.
- Gehen Sie beim Aushängen der Tür vorsichtig vor. Die Tür ist schwer!
- Wischen Sie den Garraum, den Drehteller und die Tür nach jedem Gebrauch trocken. Der während des Gerätebetriebs entstandene Dampf kondensiert auf den Wänden des Garraums und kann zur Korrosion führen.
- Reinigen Sie das Gerät regelmäßig, um eine Verschlechterung des Oberflächenmaterials zu verhindern.
- Fett- und Lebensmittelrückstände im Gerät können einen Brand und Funkenschlag verursachen, wenn die Mikrowellenfunktion genutzt wird.
- Reinigen Sie das Geräts mit einem weichen, feuchten Tuch. Verwenden Sie ausschließlich Neutralreiniger. Benutzen Sie keine Scheuermittel, scheuernde Reinigungsschwämmchen, Lösungsmittel oder Metallgegenstände.

GERÄTEBESCHREIBUNG

- Falls Sie ein Backofenspray verwenden, befolgen Sie die Sicherheitsanweisungen auf seiner Verpackung.

2.5 Innenbeleuchtung



WARNUNG!
Stromschlaggefahr.

- Bezüglich der Lampe(n) in diesem Gerät und separat verkaufter Ersatzlampen: Diese Lampen müssen extremen physikalischen Bedingungen in Haushaltsgeräten standhalten, wie z.B. Temperatur, Vibration, Feuchtigkeit, oder sollen Informationen über den Betriebszustand des Gerätes anzeigen. Sie sind nicht für den Einsatz in anderen Geräten vorgesehen und nicht für die Raumbeleuchtung geeignet.
- Dieses Produkt enthält eine Lichtquelle der Energieeffizienzklasse G.
- Verwenden Sie nur Lampen mit der gleichen Leistung .

2.6 Wartung

- Wenden Sie sich zur Reparatur des Geräts an den autorisierten Kundendienst.
- Dabei dürfen ausschließlich Originalersatzteile verwendet werden.

2.7 Entsorgung



WARNUNG!
Verletzungs- und Erstickungsgefahr.

- Informationen zur Entsorgung des Geräts erhalten Sie von Ihrer Gemeindeverwaltung.
- Trennen Sie das Gerät von der Stromversorgung.
- Schneiden Sie das Netzkabel in der Nähe des Geräts ab, und entsorgen Sie es.
- Entfernen Sie das Türschloss, um zu verhindern, dass sich Kinder, oder Haustiere im Gerät einschließen.

3. GERÄTEBESCHREIBUNG

3.1 Gesamtansicht

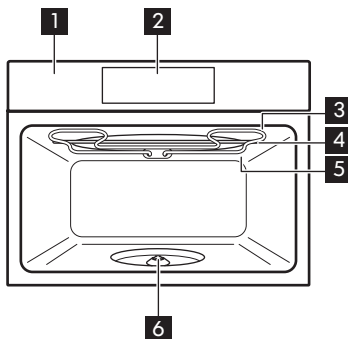

- 1 Bedienfeld
- 2 Display
- 3 Heizelement
- 4 Mikrowellengenerator
- 5 Lampe

- 6 Drehscheiben-Achse

EIN- UND AUSSCHALTEN DES BACKOFENS

3.2 Zubehör

Drehteller-Set

Zur Zubereitung von Lebensmitteln.

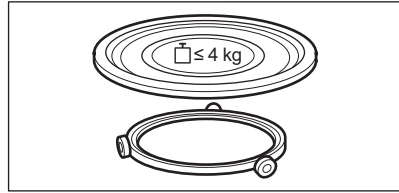

Brat- und Fettpfanne mit Einlegerost

Zum Grillen.

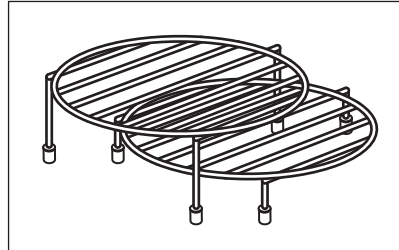

4. EIN- UND AUSSCHALTEN DES BACKOFENS

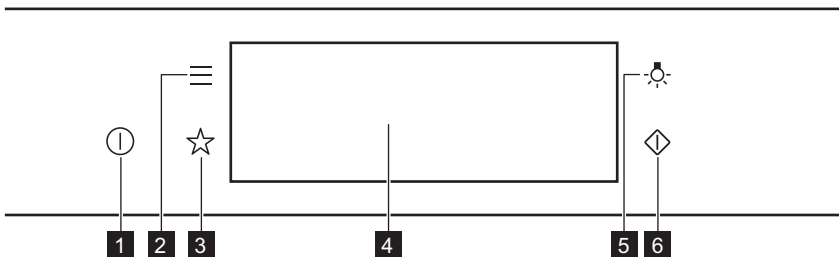

4.1 Bedienfeld





1	EIN / AUS	Gedrückt halten, um den Ofen ein- und auszuschalten.
2	Menü	Liste der Ofenfunktionen.
3	Favoriten	Liste der bevorzugten Einstellungen.
4	Display	Anzeige der aktuellen Ofeneinstellungen.
5	Lichtschalter	Ein- und Ausschalten der Beleuchtung.

EIN- UND AUSSCHALTEN DES BACKOFENS

6	Mikrowellen-Schnellstart	Einschalten der Mikrowellenfunktion (1000 W und 30 Sekunden).
----------	--------------------------	---

 START drücken.	 Wischen	 Gedrückt halten
Berühren Sie die Oberfläche mit der Fingerspitze.	Bewegen Sie die Fingerspitze über die Oberfläche.	Berühren Sie die Oberfläche 3 Sekunden lang.

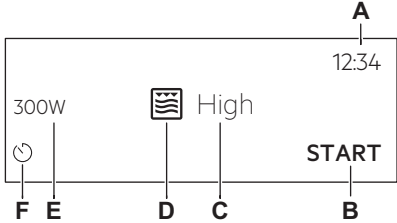
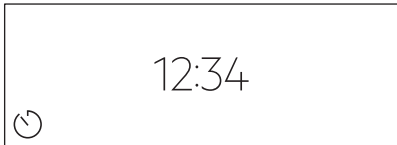







4.2 Display

	<p>Nach dem Einschalten zeigt das Display den Hauptbildschirm mit der Funktion und der Standard-Grillintensität an.</p> <ul style="list-style-type: none"> A. Uhrzeit B. START/STOP C. Grillintensität D. Ofenfunktionen E. Mikrowellenleistung F. Kurzzeitwecker
	<p>Wenn Sie den Backofen 2 Minuten lang nicht benutzen, schaltet das Display in den Standby-Modus.</p>
	<p>Während des Garvorgangs zeigt das Display die eingestellten Funktionen und weitere verfügbare Optionen an.</p>

Display-Anzeigen

Grundlegende Anzeigen - Navigieren im Display.

VOR DER ERSTEN VERWENDUNG

 Bestätigen der Auswahl / Einstellung.	 Zurückblättern um eine Menüebene.	 Rückgängig machen der letzten Aktion.	 Ein- und Ausschalten der Optionen.
Alarmsignal Funktionsanzeigen – Nach Ablauf der eingestellten Gardauer ertönt der Signalton.			
 Die Funktion ist eingeschaltet.	 Die Funktion ist eingeschaltet. Der Garvorgang stoppt automatisch.	 Das Alarmsignal ist ausgeschaltet.	
Timer-Anzeigen			
 Einstellen der Funktion: Zeitvorwahl.		 Abbrechen der Einstellung.	



5. VOR DER ERSTEN VERWENDUNG



WARNUNG!

Siehe Kapitel Sicherheitshinweise.

5.1 Erste Reinigung

		
Schritt 1	Schritt 2	Schritt 3
Entfernen Sie die Innenausstattung aus dem Backofen.	Feuchten Sie ein weiches Tuch mit warmem Wasser und etwas mildem Reinigungsmittel an, und reinigen Sie damit den Backofen und das Zubehör.	Setzen Sie das Zubehör in den Backofen.

5.2 Erste Verbindung

Nach der ersten Verbindung zeigt das Display eine Willkommensnachricht an.

Sie müssen folgende Einstellungen vornehmen: Sprache, Helligkeit, Tastentöne, Lautstärke, Uhrzeit.

6. TÄGLICHER GEBRAUCH



WARNUNG!

Siehe Kapitel Sicherheitshinweise.

6.1 So stellen Sie die Funktion ein: Grill + MW, Grill

Der Backofen kann bei Verwendung der folgenden Funktion Geräusche machen: Grill + MW. Diese sind bei dieser Funktion normal.

Einstellen der Funktion: Grill + MW	
Schritt 1	Setzen Sie den niedrigen Grillrost ein.
Schritt 2	Schalten Sie den Backofen ein. Das Display zeigt die Standard-Ofenfunktion an.
Schritt 3	Drücken Sie auf das Symbol der Ofenfunktion, um das Untermenü aufzurufen.
Schritt 4	Wählen Sie die Funktion:  . Drücken Sie: OK.
Schritt 5	Wählen Sie die Grillstärke.
Funktion	Stufe der Grillintensität
Lo	Niedrig
Hi	Hoch
Schritt 6	Drücken Sie: OK.
Schritt 7	Drücken Sie: START .
STOP – zum Ausschalten des Ofens drücken.	
Schritt 8	Schalten Sie den Backofen aus.

Die Mikrowellenleistung ist bei folgender Funktion auf 500 W begrenzt: Grill + MW.

Einstellen der Funktion: Grill	
Schritt 1	Setzen Sie den hohen Grillrost ein.
Schritt 2	Schalten Sie den Backofen ein. Das Display zeigt die Standard-Ofenfunktion an.
Schritt 3	Drücken Sie auf das Symbol der Ofenfunktion, um das Untermenü aufzurufen.
Schritt 4	Wählen Sie die Funktion:  . Drücken Sie: OK.
Schritt 5	Wählen Sie die Grillstärke.
Funktion	Stufe der Grillintensität
Lo	Niedrig
Hi	Hoch
Schritt 6	Drücken Sie: OK.
Schritt 7	Drücken Sie: START .
STOP - Drücken Sie zum Ausschalten der Funktion.	
Schritt 8	Schalten Sie den Backofen aus.

6.2 Einstellung: Mikrowellengarfunktionen

Schritt 1	Schalten Sie den Backofen ein.
Schritt 2	Drücken Sie auf das Symbol der Ofenfunktion, um das Untermenü aufzurufen.
Schritt 3	Wählen Sie die Mikrowellen-Ofenfunktion und drücken Sie: OK. Das Display zeigt die Mikrowellenleistung an.

TÄGLICHER GEBRAUCH

Schritt 4	Einstellen: Mikrowellenleistung. Drücken Sie: OK .
Schritt 5	Drücken Sie: START .
STOP - Drücken Sie zum Ausschalten der Funktion.	
Schritt 6	Schalten Sie den Backofen aus.

Die maximale Dauer der Mikrowellenfunktionen hängt von der eingestellten Mikrowellenleistung ab:

MIKROWELLENLEISTUNG	MAXIMALE DAUER
100 – 600 W	59 Minuten
Mehr als 600 W	7 Minuten

 Wenn Sie die Tür öffnen, wird die Funktion ausgeschaltet. Drücken Sie zum erneuten Einschalten **START** .

Wählen Sie eine Verknüpfung!





6.3 Benutzung: Mikrowellen-Schnellstart





Schritt 1	Halten Sie  gedrückt. Die Mikrowelle schaltet sich für 30 Sekunden ein.	
Schritt 2	Verlängern der Gardauer:	
	Drücken Sie auf den Laufzeitwert, um die Zeiteinstellungen aufzurufen. Stellen Sie die Gardauer ein.	Drücken Sie +30 s .
Die Mikrowelle kann jederzeit eingeschaltet werden mit: Mikrowellen-Schnellstart.		

6.4 Ofenfunktionen

STANDARDFUNKTIONEN

Ofenfunktion	Gerät
 Grill	Zum Grillen dünner Lebensmittel und zum Toasten von Brot.
 Grill + MW	Schnelleres Garen und Bräunen. Sie können zwei Grillstufen einstellen: niedrig und hoch.
 Mikrowelle	Aufwärmen, Kochen, Leistungsbereich: 100 - 1000 W

MIKROWELLE

Ofenfunktion	Gerät
 Auftauen	Auftauen von Fleisch, Fisch, Kuchen, Leistungsbereich: 100 - 200 W
 Schmelzen	Schmelzen von Schokolade und Butter, Leistungsbereich: 100 - 400 W
 Aufwärmen	Aufheizen von vorbereiteten Mahlzeiten und empfindlichen Lebensmitteln, Leistungsbereich: 300 - 700 W
 Popcorn Funktion	Zubereiten von Popcorn, Leistungsbereich: 700 - 1000 W
 Flüssigkeiten	Aufwärmen von Getränken und Suppen, Leistungsbereich: 800 - 1000 W

7. UHRFUNKTIONEN

7.1 Beschreibung der Uhrfunktionen

Uhrfunktion	Verwendung
Garzeitdauer	Einstellen der Garzeitdauer. Max. 23 Std. 59 Min.
Optionen nach Ablauf	Einstellung, wann der Timer mit dem Zählen aufhört.
Zeitverlängerung	Verlängern der Gardauer.
Erinnerung	Einstellen eines Countdowns. Max. 23 Std. 59 Min. Diese Funktion wirkt sich nicht auf den Betrieb des Backofens aus.
Uptimer	Überwachung der Einschaltdauer der Funktion. Uptimer - Sie können sie ein- oder ausschalten.

7.2 Einstellung: Uhrfunktionen

Einstellen der Uhr	
Schritt 1	Drücken Sie: Uhrzeit.
Schritt 2	Stellen Sie die Zeit ein. Drücken Sie: OK .

Einstellen der Gardauer	
Schritt 1	Wählen Sie die Ofenfunktion.
Schritt 2	Drücken Sie:  .
Schritt 3	Stellen Sie die Zeit ein. Drücken Sie: OK .

Auswählen der Option „Ende“	
Schritt 1	Wählen Sie die Ofenfunktion.

Auswählen der Option „Ende“	
Schritt 2	Drücken Sie:  .
Schritt 3	Stellen Sie die Gardauer ein.
Schritt 4	Drücken Sie: ● ● ● .
Schritt 5	Drücken Sie: Optionen nach Ablauf.
Schritt 6	Wählen Sie die gewünschte: Optionen nach Ablauf.
Schritt 7	Drücken Sie: OK . Wiederholen Sie die Aktion, bis das Display den Hauptbildschirm anzeigt.

Verlängern der Gardauer
Wenn 10 % der Gardauer verbleiben und die Speise nicht fertig zu sein scheint, können Sie die Gardauer verlängern. Sie können auch die Ofenfunktion ändern.
Drücken Sie +1min , um die Gardauer zu verlängern.

Ändern der Timer-Einstellungen	
Schritt 1	Drücken Sie:  .
Schritt 2	Stellen Sie den Timerwert ein.
Schritt 3	Drücken Sie: OK .
Sie können die eingestellte Zeit jederzeit während des Garvorgangs ändern.	

8. VERWENDUNG: ZUBEHÖR

8.1 Einsetzen des Zubehörs

Verwenden Sie nur geeignetes Kochgeschirr und Material. Siehe Kapitel „Ratschläge und Tipps“, geeignetes Kochgeschirr und Materialien für die Mikrowelle.

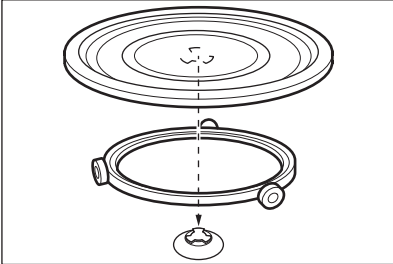
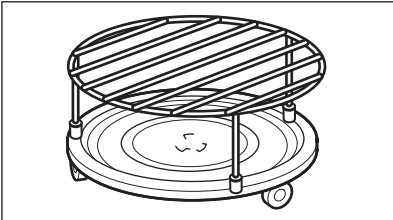

<p>Drehteller-Set: Garen Sie die Speisen stets auf dem Turntable-Set. Setzen Sie die Rollenführung um die Spindel des Turntables. Legen Sie das Turntable-Glas auf die Rollenführung. Verwenden Sie ausschließlich das mit dem Backofen gelieferte Turntable-Set.</p>	
<p>Brat- und Fettpfanne mit Einlegerost: Legen Sie den Grillrost mit den Silikonkappen nach unten auf das Turntable-Set.</p>	

9. ZUSATZFUNKTIONEN

9.1 So speichern Sie: Favoriten



Sie können Ihre bevorzugten Einstellungen, wie die Ofenfunktion, Gardauer oder die Reinigungsfunktion speichern. Sie können 3 Favoriten speichern.

<p>Schritt 1</p>	<p>Schalten Sie den Backofen ein.</p>
<p>Schritt 2</p>	<p>Wählen Sie die gewünschte Einstellung aus.</p>
<p>Schritt 3</p>	<p>Drücken Sie: . Wählen Sie: Favoriten.</p>
<p>Schritt 4</p>	<p>Wählen Sie: Aktuelle Einstellungen speichern.</p>

Schritt 5	Drücken Sie + , um die Einstellung hinzuzufügen zur Liste: Favoriten. Drücken Sie OK .
<p> – zum Zurücksetzen der Einstellung drücken.</p> <p> – zum Abbrechen der Einstellung drücken.</p>	

9.2 Tastensperre

Diese Funktion verhindert ein versehentliches Verstellen der Ofenfunktion.

Schritt 1	Schalten Sie den Backofen ein.
Schritt 2	Stellen Sie eine Backofenfunktion ein.
Schritt 3	  – gleichzeitig drücken, um die Funktion einzuschalten.
Zum Ausschalten der Funktion wiederholen Sie Schritt 3.	

9.3 Kühlgebläse

Wenn der Backofen in Betrieb ist, wird das Kühlgebläse automatisch eingeschaltet, um die Ofenoberflächen zu kühlen. Wenn Sie den Backofen ausschalten kann das Kühlgebläse weiter laufen, bis der Ofen abgekühlt ist.

10. TIPPS UND HINWEISE

10.1 Garempfehlungen

<p>Die Temperaturen und Garzeiten in den Tabellen sind nur Richtwerte. Sie hängen von den Rezepten sowie der Qualität und Menge der verwendeten Zutaten ab.</p> <p>Ihr Backofen gart unter Umständen anders als Ihr früherer Backofen. Die Hinweise unten enthalten die empfohlenen Ofenfunktionen und Einstellungen der Gardauer für die einzelnen Speisen. Finden Sie für ein bestimmtes Rezept keine konkreten Angaben, orientieren Sie sich an einem ähnlichem Rezept.</p> <p>Weitere Garempfehlungen finden Sie in den Kochtabellen auf unserer Website. Um die Gartipps zu finden, suchen Sie die PNC-Nummer auf dem Typenschild, das sich am vorderen Rahmen des Garraums befindet.</p>

10.2 Mikrowellenempfehlungen

 **Kochen wir!**

TIPPS UND HINWEISE

Legen Sie die Lebensmittel nicht direkt auf den Drehteller. Verwenden Sie stets mikrowellengeeignetes Kochgeschirr.

Stellen Sie das Kochgeschirr mittig auf den Drehteller.

Der Kontakt mit zu heißen oder zu kalten Gegenständen kann den Drehteller beschädigen.

Lebensmittel nach der Hälfte der Auftau- und Garzeit wenden oder umrühren.

Flüssige Speisen gelegentlich umrühren.

Rühren Sie das Gericht vor dem Servieren um.

Decken Sie das Gericht zum Garen und Aufwärmen ab.

Stellen Sie einen Löffel in die Flasche oder das Glas, wenn Sie Getränke erwärmen, um eine bessere Hitzeverteilung zu erreichen.

Geben Sie die Speisen ohne Verpackung in den Ofen. Fertiggerichte in Verpackungen können nur in den Ofen gegeben werden, wenn die Verpackung mikrowellengeeignet ist (prüfen Sie die Informationen auf der Verpackung).



Speisezubereitung in der Mikrowelle

Garen Sie Speisen abgedeckt. Speisen nur dann ohne Abdeckung garen, wenn eine Kruste gewünscht ist.

Verkohlen Sie die Speisen nicht, indem Sie die Leistung zu hoch und die Zeit zu lang einstellen. Die Speise kann austrocknen, verbrennen oder einen Brand verursachen.

Der Ofen eignet sich nicht zum Kochen von Eiern in der Schale oder zum Zubereiten von Schnecken im Schneckenhaus, da diese platzen können. Stechen Sie das Eigelb oder Spiegelei an, bevor Sie es erwärmen.

Stechen Sie Speisen mit Haut oder Schale mehrfach an, bevor Sie sie garen.

Gemüse in gleich große Stücke schneiden.

Nachdem Sie den Backofen ausgeschaltet haben, nehmen Sie die Speisen heraus und lassen Sie einige Minuten stehen, damit die Wärme gleichmäßig verteilt wird.



Auftauen in der Mikrowelle

Tiefgekühlte Lebensmittel aus der Verpackung nehmen und auf einen umgedrehten Teller geben, der auf einem Behälter steht, damit die Auftauflüssigkeit abtropfen kann. Alternativ kann auch ein Abtaugitter oder ein Plastiksieb verwendet werden.

Bereits angetaute Stücke nacheinander herausnehmen.

Durch Einstellen einer höheren Mikrowellenleistung kann Obst und Gemüse ohne vorheriges Auftauen gegart werden.

10.3 Mikrowellengeeignetes Kochgeschirr und Materialien

Verwenden Sie nur mikrowellengeeignetes Kochgeschirr und Materialien. Verwenden Sie die folgende Tabelle als Referenz.

Prüfen Sie vor der Verwendung die Kochgeschirr- und Materialspezifikationen.

Kochgeschirr / Material				
Feuerfestes Glas und Porzellan ohne Metallteile, z. B. hitzebeständiges Glas	✓	✓	✓	✓

















TIPPS UND HINWEISE

Kochgeschirr / Material				
Nicht feuerfestes Glas und Porzellan ohne Verzierung aus Silber, Gold, Platin oder Metall	✓	x	x	x
Glas und Glaskeramik aus hitze-/frostbeständigem Material	✓	✓	✓	✓
Keramik und Steingut ohne Quarz- oder Metallteile oder metallhaltige Glasur	✓	✓	x	x
Keramik, Porzellan und Steingut mit unglasiertem Boden oder mit kleinen Löchern, z. B. auf den Griffen	x	x	x	x
Hitzebeständiger Kunststoff bis 200 °C	✓	✓	x	x
Pappe, Papier	✓	x	x	x
Frischhaltefolie	✓	x	x	x
Bratfolie mit mikrowelleneigenem Verschluss	✓	✓	x	x
Bratgeschirr aus Metall, z. B. Emaille, Gusseisen	x	x	✓	x
Backformen, schwarz lackiert oder silikonbeschichtet	x	x	✓	x
Kochgeschirr für die Mikrowelle, z. B. Knusperpfanne	x	✓	x	x
Brat- und Fettpfanne mit Einlegerost	x	x	✓	✓

TIPPS UND HINWEISE

10.4 Empfohlene Leistungseinstellungen für verschiedene Arten von Lebensmitteln





Die Angaben in der Tabelle sind Richtwerte.

800 – 1000 W					
 Anbraten zu Beginn des Garvorgangs			 Erhitzen von Flüssigkeiten		
500 – 700 W					
 Garen von Gemüse	 Garen von Eiergerichten	 Köcheln von Eintöpfen	 Köcheln von Reis	 Erwärmen von Eintellergerichten	 Auftauen und Aufwärmen gefrorener Speisen
300 - 400 W					
 Schmelzen von Käse, Schokolade, Butter	 Garen/Erwärmen von empfindlichen Speisen		 Weiter garen		
100 - 200 W					
 Erwärmen von Babynahrung	 Auftauen von Brot	 Auftauen von Obst und Kuchen	 Auftauen von Käse, Sahne, Butter	 Auftauen von Fleisch, Fisch	





10.5 Gartabellen für Prüfinstitute

Informationen für Prüfinstitute

Tests gemäß IEC 60705.

MIKROWELLEN-FUNKTION	 (W)	 (kg)		 (Min.)	
Biskuit	600	0.475	Drehteller-Set	5 - 7	-
Hackbraten	500	0.9	Drehteller-Set	18 - 20	-
Eierstich	500	1	Drehteller-Set	15 - 17	-
Fleisch auftauen	200	0.5	Drehteller-Set	8 - 9	-

**Verwenden Sie die Funktion: Mikrowelle + Grill.
Verwenden Sie den niedrigen Grillrost.**

MIKROWELLENKOM-BIFUNKTION	 (W)	 Stufe der Grill- intensität	 (Min.)	
Kartoffelgratin, 1,1 kg	300	niedrig	30 - 35	-
Hähnchen, 1,1 kg	300	Hoch	30 - 35	Legen Sie das Fleisch in einen runden Glasbehäl- ter.

11. REINIGUNG UND PFLEGE





WARNUNG!

Siehe Kapitel Sicherheitshinweise.

FEHLERSUCHE

11.1 Hinweise zur Reinigung

 <p>Reinigungs- mittel</p>	<p>Feuchten Sie ein weiches Tuch mit warmem Wasser und etwas mildem Reinigungsmittel an, und reinigen Sie damit die Vorderseite des Backofens.</p>
	<p>Reinigen Sie die Metalloberflächen mit einer Reinigungslösung.</p>
	<p>Reinigen Sie Flecken mit einem milden Reinigungsmittel.</p>
 <p>Täglicher Ge- brauch</p>	<p>Reinigen Sie den Garraum nach jedem Gebrauch. Fettansammlungen oder andere Speisereste könnten einen Brand verursachen. Entfernen Sie Speise- und Fettreste vorsichtig von der Garraumdecke.</p>
	<p>Lassen Sie die Speisen nicht länger als 20 Minuten im Backofen stehen. Trocknen Sie den Garraum nach jedem Gebrauch mit einem weichen Tuch ab.</p>
 <p>Zubehör</p>	<p>Reinigen Sie alle Zubehörteile nach jedem Gebrauch und lassen Sie sie trocknen. Warten Sie vor dem Reinigen, bis der Drehteller kalt ist. Es besteht die Gefahr, dass der Drehteller bricht. Feuchten Sie ein weiches Tuch mit warmem Wasser und einem milden Reinigungsmittel an. Reinigen Sie die Zubehörteile nicht im Geschirrspüler.</p>
	<p>Reinigen Sie das Zubehör mit Antihafbeschichtung nicht mit Scheuermitteln oder scharfkantigen Gegenständen.</p>



12. FEHLERSUCHE









WARNUNG!

Siehe Kapitel Sicherheitshinweise.

12.1 Was zu tun ist, wenn ...



 <p>Der Backofen schaltet sich nicht ein oder heizt nicht auf</p>	
 <p>Mögliche Ursache</p>	 <p>Problembesehung</p>
<p>Der Backofen ist nicht oder nicht ordnungsgemäß an die Spannungsversorgung angeschlossen.</p>	<p>Prüfen Sie, ob der Backofen ordnungsgemäß an die Spannungsversorgung angeschlossen ist.</p>



 Der Backofen schaltet sich nicht ein oder heizt nicht auf	
 Mögliche Ursache	 Problembesehung
Die Uhrzeit ist nicht eingestellt.	Stellen Sie die Uhr ein; Einzelheiten finden Sie im Kapitel „Uhrfunktionen“, Einstellung: Uhrfunktionen.
Die Tür ist nicht richtig geschlossen.	Schließen Sie die Tür vollständig.
Die Sicherung ist durchgebrannt.	Vergewissern Sie sich, dass die Sicherung der Grund für die Störung ist. Wenn das Problem erneut auftritt, wenden Sie sich an einen qualifizierten Elektriker.
Die Kindersicherung des Backofens ist eingeschaltet.	Siehe Kapitel „Menü“, Untermenü: Optionen.

 Komponenten	
 Beschreibung	 Problembesehung
Die Lampe ist durchgebrannt.	Ersetzen Sie die Lampe, Einzelheiten finden Sie im Kapitel „Pflege und Reinigung“, Austausch: Lampe.
Das Drehteller-Set macht Geräusche.	Es befinden sich Lebensmittelrückstände unter dem Drehteller-Set.

12.2 Handhabung: Fehlercodes

Im Falle eines Softwarefehlers zeigt das Display eine Fehlermeldung an. Dieser Abschnitt enthält eine Liste mit Störungen, die Sie selbst beheben können.

 Code und Beschreibung	 Abhilfe
F240, F439 – Die Sensorfelder des Displays funktionieren nicht einwandfrei.	Reinigen Sie die Displayoberfläche. Stellen Sie sicher, dass sich kein Schmutz auf den Sensordfeldern befindet.

 Code und Beschreibung	 Abhilfe
F908 – Das Backofensystem kann sich nicht mit dem Bedienfeld verbinden.	Schalten Sie den Backofen aus und wieder ein.

12.3 Servicedaten

Wenn Sie das Problem nicht selbst lösen können, wenden Sie sich an Ihren Händler oder einen autorisierten Kundendienst.

Die vom Kundendienst benötigten Daten finden Sie auf dem Typenschild. Das Typenschild befindet sich auf dem vorderen Rahmen des Garraums. Entfernen Sie das Typenschild nicht vom Garraum.

Wir empfehlen Ihnen, die Daten hier zu notieren:	
Modell (MOD.):
Produktnummer (PNC)
Seriennummer (S.N.)

13. ENERGIEEFFIZIENZ

13.1 Energiesparen

 Der Backofen verfügt über Funktionen, mit deren Hilfe Sie beim täglichen Kochen Energie sparen können.

Achten Sie darauf, dass die Backofentür während des Ofenbetriebs geschlossen ist. Die Backofentür darf während des Garvorgangs nicht zu oft geöffnet werden. Halten Sie die Türdichtung sauber und stellen Sie sicher, dass sie sich fest in der richtigen Position befindet.

Heizen Sie, wenn möglich, den Backofen nicht vor.

Wenn Sie mehrere Speisen gleichzeitig zubereiten, halten Sie die Unterbrechungen beim Backen so kurz wie möglich.

Garen bei ausgeschalteter Backofenbeleuchtung

Schalten Sie die Lampe während des Garvorgangs aus. Schalten Sie sie nur ein, wenn Sie sie benötigen.

14. MENÜSTRUKTUR

14.1 Menü

Drücken Sie , um Menü zu öffnen.

Menüpunkt		Gerät
Favoriten		Liste der bevorzugten Einstellungen.
Optionen		Einstellen der Backofenkonfiguration.
Einstellungen	Setup	Einstellen der Backofenkonfiguration.
	Service	Anzeige der Softwareversion und Konfiguration.

14.2 Untermenü für: Optionen

Untermenü	Verwendung
Backofenbeleuchtung	Ein- und Ausschalten der Beleuchtung.
Kindersicherung	Verhindert ein versehentliches Einschalten des Ofens. Wenn die Option eingeschaltet ist, erscheint „Kindersicherung“ auf dem Display, wenn Sie den Backofen einschalten. Um den Backofen verwenden zu können, wählen Sie die Buchstaben des Codes in alphabetischer Reihenfolge. Der Zugriff auf den Timer, die Fernsteuerung und die Lampe sind mit eingeschalteter Kindersicherung möglich.
Zeitanzeige	Ein- und Ausschalten der Uhr.
Digitale Uhrzeitanzeige	Ändern des Formats der angezeigten Uhrzeit.

14.3 Untermenü für: Setup

Untermenü	Beschreibung
Sprache	Einstellen der Backofen-Sprache.
Helligkeit	Auswahl der Helligkeit.
Tastentöne	Ein- und Ausschalten der Tastentöne der Sensorfelder. Es ist nicht möglich, den Signalton für Folgendes stummzuschalten: ①.

DAS IST GANZ EINFACH!

Untermenü	Beschreibung
Lautstärke	Einstellen der Lautstärke der Tastentöne und Signale.
Uhrzeit	Einstellen der aktuellen Uhrzeit und des Datums.

14.4 Untermenü von: Service

Untermenü	Bezeichnung
DEMO	Aktivierungs-/Deaktivierungscode: 2468
Softwareversion	Informationen zur Softwareversion.
Gerät auf Werkseinstellungen zurücksetzen	Wiederherstellung der Werkseinstellungen.

15. DAS IST GANZ EINFACH!

Vor der ersten Inbetriebnahme müssen Sie folgende Einstellungen vornehmen:

Sprache	Helligkeit	Tastentöne	Lautstärke	Uhrzeit
---------	------------	------------	------------	---------





Machen Sie sich vertraut mit den Symbolen auf dem Bedienfeld und Display:

 EIN / AUS	 Menü	 Favoriten	 Kurzeitwecker	START / STOP
--	---	--	--	--------------



Beginnen Sie mit der Benutzung des Backofens

MW-Schnellstart	Sie können jederzeit die Funktion Schnellstart Mikrowelle mit den Voreinstellungen nutzen: 30 Sek. / 1000 W.	Drücken Sie:  .
------------------------	---	--

			
---	---	---	---



Erhitzen / Garen 100 - 1000 W	Garen / Bräunen Intensität: niedrig / hoch	Garen / Bräunen	Erhitzen von Flüssigkeiten 800 - 1000 W
			
Aufwärmen 300 - 700 W	Auftauen 100 - 200 W	Schmelzen 100 - 400 W	Zubereiten von Popcorn 700 - 1000 W

Einstellungen der Mikrowelle		Mikrowellentipps
Mikrowellenleistung:	Maximale Dauer:	Decken Sie das Gericht zum Garen und Aufwärmen ab. Lebensmittel nach der Hälfte der Auftau- und Garzeit wenden oder umrühren. Stecken Sie beim Erwärmen von Flüssigkeiten einen Löffel in den Behälter. Geben Sie die Speisen ohne Verpackung in den Backofen (nur mikrowelleneeignet).
100 – 600 W	59 Min.	
> 600 W	7 Min.	

Beginnen Sie mit dem Kochen				
Schritt 1	Schritt 2	Schritt 3	Schritt 4	Schritt 5
 - Drücken, um den Backofen einzuschalten.	 ... - Wählen Sie die Funktion.	W – Einstellung der Mikrowellenleistung.	OK - Zur Bestätigung drücken.	START - Zum Starten des Garvorgangs drücken.

Verwenden Sie die Schnellfunktionen zur Einstellung der Gardauer	
10% Finish Assist Verwenden Sie 10 % Finish Assist, um eine Zeitverlängerung festzulegen, wenn 10 % der Garzeit verbleiben.	Drücken Sie zur Verlängerung der Gardauer +1min.

16. UMWELTTIPPS

Recyceln Sie Materialien mit dem Symbol . Entsorgen Sie die Verpackung in den entsprechenden Recyclingbehältern. Recyceln Sie zum Umwelt- und Gesundheitsschutz elektrische und elektronische Geräte. Entsorgen Sie Geräte mit diesem Symbol  nicht mit

DAS IST GANZ EINFACH!

dem Hausmüll. Bringen Sie das Gerät zu Ihrer örtlichen Sammelstelle oder wenden Sie sich an Ihr Gemeindeamt.

FOR PERFECT RESULTS

Thank you for choosing this AEG product. We have created it to give you impeccable performance for many years, with innovative technologies that help make life simpler – features you might not find on ordinary appliances. Please spend a few minutes reading to get the very best from it.

Visit our website to:



Get usage advice, brochures, trouble shooter, service and repair information:
www.aeg.com/support



Register your product for better service:
www.registeraeg.com



Buy Accessories, Consumables and Original spare parts for your appliance:
www.aeg.com/shop

CUSTOMER CARE AND SERVICE

Always use original spare parts.

When contacting our Authorised Service Centre, ensure that you have the following data available: Model, PNC, Serial Number.

The information can be found on the rating plate.

Warning / Caution-Safety information

General information and tips

Environmental information

Subject to change without notice.

CONTENTS

1. SAFETY INFORMATION.....	94	3.2 Accessories.....	101
1.1 Children and vulnerable people safety.....	94	4. HOW TO TURN OVEN ON AND OFF.....	101
1.2 General Safety.....	95	4.1 Control panel.....	101
2. SAFETY INSTRUCTIONS.....	97	4.2 Display.....	102
2.1 Installation.....	97	5. BEFORE FIRST USE.....	103
2.2 Electrical connection.....	98	5.1 Initial Cleaning	104
2.3 Use.....	99	5.2 First connection.....	104
2.4 Care and cleaning.....	99	6. DAILY USE.....	104
2.5 Internal lighting.....	100	6.1 How to set the function: Grill + MW, Grill.....	104
2.6 Service.....	100	6.2 How to set: Microwave heating functions.....	106
2.7 Disposal.....	100	6.3 How to use: Microwave quick start	106
3. PRODUCT DESCRIPTION.....	101	6.4 Heating functions.....	107
3.1 General overview.....	101		

SAFETY INFORMATION

7. CLOCK FUNCTIONS.....	108	11. CARE AND CLEANING.....	115
7.1 Clock functions description.....	108	11.1 Notes on cleaning.....	115
7.2 How to set: Clock functions.....	108	12. TROUBLESHOOTING.....	116
8. HOW TO USE: ACCESSORIES.....	110	12.1 What to do if.....	116
8.1 Inserting accessories.....	110	12.2 How to manage: Error codes.....	117
9. ADDITIONAL FUNCTIONS.....	110	12.3 Service data.....	117
9.1 How to save: Favourites.....	110	13. ENERGY EFFICIENCY.....	117
9.2 Function lock.....	111	13.1 Energy saving.....	117
9.3 Cooling fan.....	111	14. MENU STRUCTURE.....	118
10. HINTS AND TIPS.....	111	14.1 Menu.....	118
10.1 Cooking recommendations.....	111	14.2 Submenu for: Options.....	118
10.2 Microwave recommendations ...	111	14.3 Submenu for: Setup.....	119
10.3 Microwave suitable cookware and materials	112	14.4 Submenu for: Service.....	119
10.4 Recommended power settings for different kinds of food.....	113	15. IT'S EASY!.....	119
10.5 Cooking tables for test institutes	114	16. ENVIRONMENTAL CONCERNS.....	121

1. SAFETY INFORMATION

Before the installation and use of the appliance, carefully read the supplied instructions. The manufacturer is not responsible for any injuries or damage that are the result of incorrect installation or usage. Always keep the instructions in a safe and accessible location for future reference.

1.1 Children and vulnerable people safety

- This appliance can be used by children aged from 8 years and above and persons with reduced physical, sensory or mental capabilities or lack of experience and knowledge if they have been given supervision or instruction concerning the use of the appliance in a safe way and understand the hazards involved. Children of less than 8 years of age and persons with very extensive and complex disabilities shall be kept away from the appliance unless continuously supervised.
- Children should be supervised to ensure that they do not play with the appliance.

- Keep all packaging away from children and dispose of it appropriately.
- **WARNING:** Keep children and pets away from the appliance when it operates or when it cools down. Accessible parts become hot during use.
- If the appliance has a child safety device, it should be activated.
- Children shall not carry out cleaning and user maintenance of the appliance without supervision.

1.2 General Safety

- This appliance is for cooking purposes only.
- This appliance is designed for single household domestic use in an indoor environment.
- This appliance may be used in, offices, hotel guest rooms, bed & breakfast guest rooms, farm guest houses and other similar accommodation where such use does not exceed (average) domestic usage levels.
- Only a qualified person must install this appliance and replace the cable.
- Do not use the appliance before installing it in the built-in structure.
- Disconnect the appliance from the power supply before carrying out any maintenance.
- If the mains power supply cable is damaged, it must be replaced by the manufacturer, its Authorised Service Centre or similarly qualified persons to avoid an electrical hazard.
- **WARNING:** Ensure that the appliance is switched off before replacing the lamp to avoid the possibility of electric shock.
- **WARNING:** The appliance and its accessible parts become hot during use. Care should be taken to avoid touching heating elements.
- Always use oven gloves to remove or insert accessories or ovenware.

SAFETY INFORMATION

- Use only the turntable and the turntable support designed for this appliance.
- Do not activate the microwave function when the appliance is empty. Metal parts inside the cavity can create electric arcing.
- Metallic containers for food and beverages are not allowed during microwave cooking. This requirement is not applicable if the manufacturer specifies size and shape of metallic containers suitable for microwave cooking.
- **WARNING:** If the door or door seals are damaged, the appliance must not be operated until it has been repaired by a qualified person.
- **WARNING:** Only a qualified person can carry out any service or repair operation that involves the removal of a cover which gives protection against exposure to microwave energy.
- **WARNING:** Do not heat liquids and other foods in sealed containers. They are liable to explode.
- Use only utensils that are suitable for use in microwave ovens.
- When heating food in plastic or paper containers, observe the appliance due to the possibility of ignition.
- The appliance is intended for heating food and beverages. Drying of food or clothing and heating of warming pads, slippers, sponges, damp cloth and similar may lead to risk of injury, ignition or fire.
- If smoke is emitted, switch off or unplug the appliance and keep the door closed in order to stifle any flames.
- Microwave heating of beverages can result in delayed eruptive boiling. Care must be taken when handling the container.
- The contents of feeding bottles and baby food jars shall be stirred or shaken and the temperature checked before consumption, in order to avoid burns.

- Eggs in their shell and whole hard-boiled eggs should not be heated in the appliance since they may explode, even after microwave heating has ended.
- The appliance should be cleaned regularly and any food deposits removed.
- Do not use a steam cleaner to clean the appliance.
- Do not use harsh abrasive cleaners or sharp metal scrapers to clean the glass door since they can scratch the surface, which may result in shattering of the glass.
- Failure to maintain the appliance in a clean condition could lead to deterioration of the surface that could adversely affect the life of the appliance and possibly result in a hazardous situation.

2. SAFETY INSTRUCTIONS

2.1 Installation

**WARNING!**

Only a qualified person must install this appliance.

- Remove all the packaging.
- Do not install or use a damaged appliance.
- Follow the installation instructions supplied with the appliance.
- Always take care when moving the appliance as it is heavy. Always use safety gloves and enclosed footwear.
- Do not pull the appliance by the handle.
- Install the appliance in a safe and suitable place that meets installation requirements.
- Keep the minimum distance from other appliances and units.
- Before mounting the appliance, check if the oven door opens without restraint.
- The appliance is equipped with an electric cooling system. It must be operated with the electric power supply.
- The built-in unit must meet the stability requirements of DIN 68930.

Cabinet minimum height (Cabinet under the work-top minimum height)	444 (460) mm
Cabinet width	560 mm
Cabinet depth	550 (550) mm
Height of the front of the appliance	455 mm

SAFETY INSTRUCTIONS

Height of the back of the appliance	440 mm
Width of the front of the appliance	595 mm
Width of the back of the appliance	559 mm
Depth of the appliance	567 mm
Built in depth of the appliance	546 mm
Depth with open door	882 mm
Ventilation opening minimum size. Opening placed on the bottom rear side	560x20 mm
Mains supply cable length. Cable is placed in the right corner of the back side	1500 mm
Mounting screws	3.5x25 mm

2.2 Electrical connection



WARNING!

Risk of fire and electric shock.

- All electrical connections should be made by a qualified electrician.
- The appliance must be earthed.
- Make sure that the parameters on the rating plate are compatible with the electrical ratings of the mains power supply.
- Always use a correctly installed shockproof socket.
- Do not use multi-plug adapters and extension cables.
- Make sure not to cause damage to the mains plug and to the mains cable. Should the mains cable need to be replaced, this must be carried out by our Authorised Service Centre.
- Do not let mains cables touch or come near the appliance door or the niche below the appliance, especially when it operates or the door is hot.
- The shock protection of live and insulated parts must be fastened in such a way that it cannot be removed without tools.
- Connect the mains plug to the mains socket only at the end of the installation. Make sure that there is access to the mains plug after the installation.
- If the mains socket is loose, do not connect the mains plug.
- Do not pull the mains cable to disconnect the appliance. Always pull the mains plug.
- Use only correct isolation devices: line protecting cut-outs, fuses (screw type fuses removed from the holder), earth leakage trips and contactors.
- The electrical installation must have an isolation device which lets you disconnect the appliance from the mains at all poles. The isolation device must have a contact opening width of minimum 3 mm.
- This appliance is supplied with a main plug and a main cable.

2.3 Use



WARNING!

Risk of injury, burns and electric shock or explosion.

- Do not change the specification of this appliance.
- Make sure that the ventilation openings are not blocked.
- Do not let the appliance stay unattended during operation.
- Deactivate the appliance after each use.
- Be careful when you open the appliance door while the appliance is in operation. Hot air can release.
- Do not operate the appliance with wet hands or when it has contact with water.
- Do not apply pressure on the open door.
- Do not use the appliance as a work surface or as a storage surface.
- Open the appliance door carefully. The use of ingredients with alcohol can cause a mixture of alcohol and air.
- Do not let sparks or open flames to come in contact with the appliance when you open the door.
- Do not put flammable products or items that are wet with flammable products in, near or on the appliance.
- Do not use microwave function to preheat the oven.



WARNING!

Risk of damage to the appliance.

- To prevent damage or discoloration to the enamel:
 - do not put aluminium foil directly on the bottom of cavity of the appliance.
 - do not put water directly into the hot appliance.
 - do not keep moist dishes and food in the appliance after you finish the cooking.
 - be careful when you remove or install the accessories.
- Discoloration of the enamel or stainless steel has no effect on the performance of the appliance.
- Always cook with the appliance door closed.
- If the appliance is installed behind a furniture panel (e.g. a door) make sure the door is never closed when the appliance operates. Heat and moisture can build up behind a closed furniture panel and cause subsequent damage to the appliance, the housing unit or the floor. Do not close the furniture panel until the appliance has cooled down completely after use.

2.4 Care and cleaning



WARNING!

Risk of injury, fire, or damage to the appliance.

- Before maintenance, deactivate the appliance and disconnect the mains plug from the mains socket.
- Make sure the appliance is cold. There is the risk that the glass panels can break.
- Replace immediately the door glass panels when they are damaged. Contact the Authorised Service Centre.
- Be careful when you remove the door from the appliance. The door is heavy!

SAFETY INSTRUCTIONS

- Make sure the cavity, the turntable and the door are wiped dry after each use. Steam produced during the operation of the appliance condensates on cavity walls and can cause corrosion.
- Clean regularly the appliance to prevent the deterioration of the surface material.
- Fat and food remaining in the appliance can cause fire and electric arcing when the microwave function operates.
- Clean the appliance with a moist soft cloth. Use only neutral detergents. Do not use abrasive products, abrasive cleaning pads, solvents or metal objects.
- If you use an oven spray, follow the safety instructions on its packaging.

2.5 Internal lighting

**WARNING!**

Risk of electric shock.

- Concerning the lamp(s) inside this product and spare part lamps sold separately: These lamps are intended to withstand extreme physical conditions in household appliances, such as temperature, vibration, humidity, or are intended to signal information about the operational status of the appliance. They are not intended to be used in other applications and are not suitable for household room illumination.
- This product contains a light source of energy efficiency class G.
- Use only lamps with the same specifications.

2.6 Service

- To repair the appliance contact the Authorised Service Centre.
- Use original spare parts only.

2.7 Disposal

**WARNING!**

Risk of injury or suffocation.

- Contact your municipal authority for information on how to dispose of the appliance.
- Disconnect the appliance from the mains supply.
- Cut off the mains electrical cable close to the appliance and dispose of it.
- Remove the door catch to prevent children or pets from becoming trapped in the appliance.

3. PRODUCT DESCRIPTION

3.1 General overview

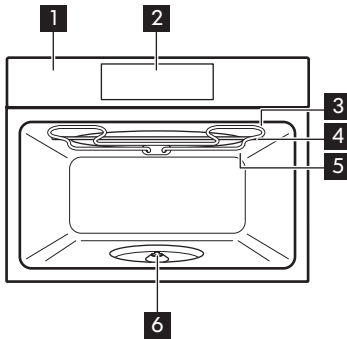

- 1** Control panel
- 2** Display
- 3** Heating element
- 4** Microwave generator
- 5** Lamp

- 6** Turntable shaft

3.2 Accessories

Turntable set
To prepare food.

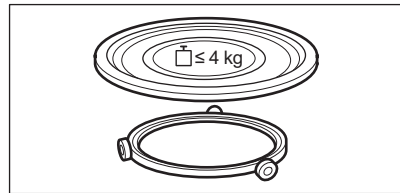

Grill rack set
To grill.

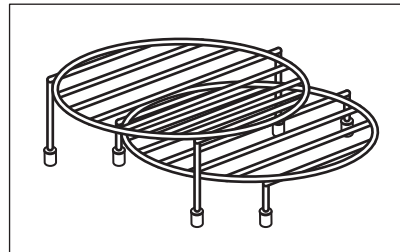



4. HOW TO TURN OVEN ON AND OFF

4.1 Control panel

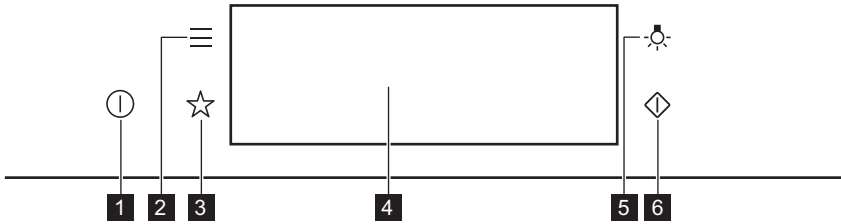
HOW TO TURN OVEN ON AND OFF









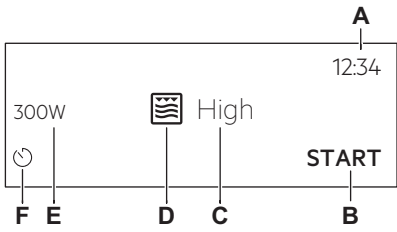

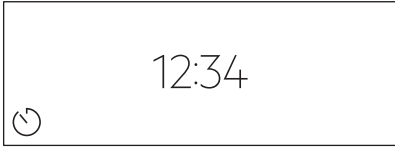

1	ON / OFF	Press and hold to turn the oven on and off.
2	Menu	Lists the oven functions.
3	Favourites	Lists the favourite settings.
4	Display	Shows the current settings of the oven.
5	Lamp switch	To turn the lamp on and off.
6	Microwave quick start	To turn on microwave function (1000 W and 30 seconds).

 <p>Press</p>	 <p>Move</p>	 <p>Press and hold</p>
Touch the surface with fingertip.	Slide fingertip over the surface.	Touch the surface for 3 seconds.

4.2 Display

	<p>After turning on, the display shows the main screen with the function and the default grill intensity.</p> <ul style="list-style-type: none"> A. Time of day B. START/STOP C. Grill intensity D. Heating functions E. Microwave power F. Timer
---	---



	<p>If you do not use the oven for 2 minutes, the display goes to standby.</p>
	<p>When you cook, the display shows the set functions and other available options.</p>

<p>Display indicators</p>			
<p>Basic indicators - to navigate on the display.</p>			
<p>OK To confirm the selection / setting.</p>	<p> To go one level back in the menu.</p>	<p> To undo the last action.</p>	<p> To turn the options on and off.</p>
<p>Sound alarm function indicators - when the set time of cooking ends, the signal sounds.</p>			
<p> The function is on.</p>	<p> The function is on. Cooking stops automatically.</p>	<p> Sound alarm is off.</p>	
<p>Timer indicators</p>			
<p> To set the function: Delayed start.</p>		<p> To cancel the setting.</p>	

5. BEFORE FIRST USE

	<p>WARNING! Refer to Safety chapters.</p>
--	--

5.1 Initial Cleaning

		
Step 1	Step 2	Step 3
Remove all accessories from the oven.	Clean the oven and the accessories with a soft cloth, warm water and a mild detergent.	Place the accessories in the oven.

5.2 First connection

The display shows welcome message after the first connection.

You have to set: Language, Display brightness, Key tones, Buzzer volume, Time of day.

6. DAILY USE



WARNING!

Refer to Safety chapters.

6.1 How to set the function: Grill + MW, Grill

The oven can make noises when using the function: Grill + MW. They are normal for this function.

Setting the function: Grill + MW	
Step 1	Insert the low grill rack.
Step 2	Turn on the oven. The display shows the default heating function.
Step 3	Press the symbol of the heating function to enter the submenu.
Step 4	Select the function:  . Press: OK.
Step 5	Select the grill intensity level.
Function	Grill intensity level
Lo	Low
Hi	High

Setting the function: Grill + MW	
Step 6	Press: OK.
Step 7	Press: START.
STOP - press to turn off the oven.	
Step 8	Turn off the oven.

Microwave power is limited to 500 W when you use the function: Grill + MW.

Setting the function: Grill	
Step 1	Insert the high grill rack.
Step 2	Turn on the oven. The display shows the default heating function.
Step 3	Press the symbol of the heating function to enter the submenu.
Step 4	Select the function:  . Press: OK.
Step 5	Select the grill intensity level.
Function	Grill intensity level
Lo	Low
Hi	High
Step 6	Press: OK.
Step 7	Press: START.
STOP - press to turn off the function.	
Step 8	Turn off the oven.

6.2 How to set: Microwave heating functions

Step 1	Turn on the oven.
Step 2	Press the symbol of the heating function to enter the submenu.
Step 3	Select the microwave heating function and press: OK . The display shows: microwave power.
Step 4	Set: microwave power. Press: OK .
Step 5	Press: START .
STOP - press to turn off the function.	
Step 6	Turn off the oven.

The maximum time of microwave functions depends on microwave power you set:

MICROWAVE POWER	MAXIMUM TIME
100 - 600 W	59 minutes
More than 600 W	7 minutes

 If you open the door, the function stops. To start it again, press **START**.

Take a shortcut!





6.3 How to use: Microwave quick start

Step 1	Press and hold:  . The microwave runs for 30 s.
---------------	--



Step 2	To extend the cooking time:	
	Press on the running time value to go to the time settings. Set the cooking time.	Press +30 s .
The microwave can be switched on at any time with: Microwave quick start.		

6.4 Heating functions



STANDARD

Heating function	Application
 Grill	To grill thin pieces of food and to toast bread.
 Grill + MW	To cook food in a short time and to brown it. You can set 2 levels of grill intensity: low and high.
 Microwave	Heating up, cooking, power range: 100 - 1000 W

MICROWAVE

Heating function	Application
 Defrost	Defrosting meat, fish, cakes, power range: 100 - 200 W
 Melting	Melting chocolate and butter, power range: 100 - 400 W
 Reheat	Heating up pre-prepared meals and delicate food, power range: 300 - 700 W

CLOCK FUNCTIONS

Heating function	Application
 Popcorn	Preparing popcorn, power range: 700 - 1000 W
 Liquid	Heating up drinks and soups, power range: 800 - 1000 W

7. CLOCK FUNCTIONS

7.1 Clock functions description

Clock function	Application
Cooking time	To set the length of cooking. Maximum is 23 h 59 min.
End action	To set what happens when the timer ends counting.
Time extension	To extend cooking time.
Reminder	To set a countdown. Maximum is 23 h 59 min. This function has no effect on the operation of the oven.
Uptimer	Monitors how long the function operates. Uptimer - you can turn it on and off.

7.2 How to set: Clock functions

How to set the clock	
Step 1	Press: Time of day.
Step 2	Set the time. Press: OK.

How to set cooking time	
Step 1	Choose the heating function.

How to set cooking time

Step 2

Press: .

Step 3

Set the time. Press: **OK**.

How to choose end option

Step 1

Choose the heating function.

Step 2

Press: .

Step 3

Set the cooking time.

Step 4

Press: ● ● ●.

Step 5

Press: End action.

Step 6

Choose the preferred: End action.

Step 7

Press: **OK**. Repeat the action until the display shows the main screen.

How to extend cooking time

When 10% of cooking time is left and the food seems not to be ready, you can extend cooking time. You can also change the heating function.

Press **+1min** to extend the cooking time.

How to change timer settings

Step 1

Press: .

Step 2

Set the timer value.

Step 3

Press: **OK**.

You can change the set time during cooking at any time.

8. HOW TO USE: ACCESSORIES

8.1 Inserting accessories

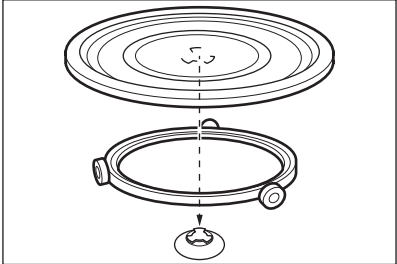
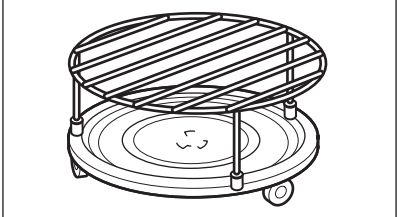

Use only suitable cookware and material. Refer to "Hints and tips" chapter, Microwave suitable cookware and materials.

<p>Turntable set: Always cook food on the turntable set. Place the roller guide around the turntable shaft. Place the turntable glass on the roller guide. Use only the turntable set supplied with the oven.</p>	
<p>Grill rack set: Place the grill rack with the silicon caps down on the turntable set.</p>	

9. ADDITIONAL FUNCTIONS



9.1 How to save: Favourites

You can save your favourite settings, such as the heating function, the cooking time or the cleaning function. You can save 3 favourite settings.

Step 1	Turn on the oven.
Step 2	Select the preferred setting.
Step 3	Press:  . Select: Favourites.
Step 4	Select: Save current settings.
Step 5	Press + to add the setting to the list of: Favourites. Press OK .
<p> - press to reset the setting.  - press to cancel the setting.</p>	

9.2 Function lock

This function prevents an accidental change of the heating function.

Step 1	Turn on the oven.
Step 2	Set a heating function.
Step 3	  - press at the same time to turn on the function.
To turn off the function repeat step 3.	

9.3 Cooling fan

When the oven operates, the cooling fan turns on automatically to keep the surfaces of the oven cool. If you turn off the oven, the cooling fan can continue to operate until the oven cools down.

10. HINTS AND TIPS

10.1 Cooking recommendations



The temperature and cooking times in the tables are guidelines only. They depend on the recipes and the quality and quantity of the ingredients used.
 Your oven may cook differently to the oven you had before. The hints below show recommended heating functions and settings for cooking time for specific types of the food.
 If you cannot find the settings for a special recipe, look for the similar one.
 For more cooking recommendations refer to cooking tables on our website. To find the Cooking Hints check the PNC number on the rating plate on the front frame of the oven cavity.

10.2 Microwave recommendations

Let's cook!

Do not place the food directly on the turntable. Always use the microwave suitable cookware. Place the cookware in the middle of the turntable.

Contact with too hot or too cold items can break the turntable.

Turn or stir the food halfway through the defrosting and cooking time.

Stir liquid dishes from time to time.

Stir the food before serving.

Cover the food for cooking and reheating.

Put the spoon to the bottle or glass when heating drinks to ensure better heat distribution.

Put the food into the oven without packaging. The packaged ready meals can be put into the oven only when the packaging is microwave safe (check information on the packaging).



Microwave cooking

Cook food covered. If you want to keep a crust cook food without a cover.

HINTS AND TIPS

Do not overcook the dishes by setting the power and time too high. The food can dry out, burn or cause fire.

Do not use the oven to cook eggs or snails in their shells, because they can burst. Pierce the yolk of fried egg before reheating it.

Pierce food with skin or peel several times before cooking.

Cut vegetables into similar-sized pieces.

After you turn off the oven, take the food out and let it stand for a few minutes to allow the heat distribute evenly.



Microwave defrosting





Put the frozen, unwrapped food on a small upturned plate with a container below it, or on a defrosting rack or plastic sieve so that the defrosting liquid can leak out.





Remove defrosted pieces subsequently.

To cook fruit and vegetables without defrosting them first, you can use a higher microwave power.

10.3 Microwave suitable cookware and materials



For the microwave use only suitable cookware and materials. Use below table as a reference. Check the cookware / material specification before use.

Cookware / Material				
Ovenproof glass and porcelain with no metal components, e.g. heat-proof glass	✓	✓	✓	✓
Non-ovenproof glass and porcelain without any silver, gold, platinum or other metal decorations	✓	x	x	x
Glass and glass ceramic made of ovenproof / frost-proof material	✓	✓	✓	✓
Ceramic and earthenware without any quartz or metal components and glazes which contain metal	✓	✓	x	x
Ceramic, porcelain and earthenware with unglazed bottom or with small holes, e.g. on handles	x	x	x	x







Cookware / Material				
Heat-resistant plastic up to 200 °C	✓	✓	X	X
Cardboard, paper	✓	X	X	X
Clingfilm	✓	X	X	X
Roasting film with microwave safe closure	✓	✓	X	X
Roasting dishes made of metal, e.g. enamel, cast iron	X	X	✓	X
Baking tins, black lacquer or silicon-coated	X	X	✓	X
Cookware for microwave use, e.g. crisp pan	X	✓	X	X
Grill rack set	X	X	✓	✓



10.4 Recommended power settings for different kinds of food





The data in the table is for guidance only.

800 - 1000 W	
 <p>Searing at the start of the cooking process</p>	 <p>Heating liquids</p>

HINTS AND TIPS

500 - 700 W					
 Cooking vegetables	 Cooking egg dishes	 Simmering stews	 Simmering rice	 Heating one-plate meals	 Defrosting and heating frozen meals





300 - 400 W			
 Melting cheese, chocolate, butter	 Cooking / Heating delicate food		 Continuing cooking

100 - 200 W				
 Heating baby food	 Defrosting bread	 Defrosting fruit and cakes	 Defrosting cheese, cream, butter	 Defrosting meat, fish





10.5 Cooking tables for test institutes

Information for test institutes





Tests according to IEC 60705.

MICROWAVE FUNCTION	 POWER (W)	 (kg)		 (min)	
Sponge cake	600	0.475	Turntable set	5 - 7	-
Meatloaf	500	0.9	Turntable set	18 - 20	-
Egg custard	500	1	Turntable set	15 - 17	-

CARE AND CLEANING

MICROWAVE FUNCTION	 POWER (W)	 (kg)		 (min)	
Meat defrosting	200	0.5	Turntable set	8 - 9	-

**Use the function: Microwave grilling.
Use the low grill rack.**

MICROWAVE COMBI FUNCTION	 POWER (W)	 Grill intensity level	 (min)	
Potato gratin, 1.1 kg	300	low	30 - 35	-
Chicken, 1.1 kg	300	high	30 - 35	Put the meat in round glass container.



11. CARE AND CLEANING



WARNING!

Refer to Safety chapters.

11.1 Notes on cleaning

 Cleaning Agents	Clean the front of the oven with a soft cloth with warm water and a mild detergent.
	Use a cleaning solution to clean metal surfaces.
	Clean stains with a mild detergent.
 Everyday Use	Clean the cavity after each use. Fat accumulation or other residue may cause fire. Clean the oven ceiling carefully from residue and fat.
	Do not store the food in the oven for longer than 20 minutes. Dry the cavity with a soft cloth after each use.



TROUBLESHOOTING



	<p>Clean all accessories after each use and let them dry. Before cleaning, wait until the turntable is cold. There is a risk that the turntable can break. Use a soft cloth with warm water and a mild detergent. Do not clean the accessories in a dishwasher.</p>
<p>Accessories</p>	<p>Do not clean the non-stick accessories using abrasive cleaner or sharp-edged objects.</p>

12. TROUBLESHOOTING

	<p>WARNING! Refer to Safety chapters.</p>
--	--



12.1 What to do if...

 <p>The oven does not turn on or does not heat up</p>	
 <p>Possible cause</p>	 <p>Remedy</p>
<p>The oven is not connected to an electrical supply or it is connected incorrectly.</p>	<p>Check if the oven is correctly connected to the electrical supply.</p>
<p>The clock is not set.</p>	<p>Set the clock, for details refer to "Clock Functions" chapter, How to set: Clock functions.</p>
<p>The door is not closed correctly.</p>	<p>Fully close the door.</p>
<p>The fuse is blown.</p>	<p>Make sure the fuse is the cause of the problem. If the problem recurs, contact a qualified electrician.</p>
<p>The oven Child Lock is on.</p>	<p>Refer to "Menu" chapter, Submenu for: Options.</p>

 Components	
 Description	 Remedy
The lamp is burnt out.	Replace the lamp, for details refer to "Care and Cleaning" chapter, How to replace: Lamp.
The turntable set makes noise.	There is food residue below the turntable set.

12.2 How to manage: Error codes

When the software error occurs, the display shows error message. In this section, you will find the list of the problems that you can handle on your own.

 Code and description	 Remedy
F240, F439 - the touch fields on the display do not work properly.	Clean the surface of the display. Make sure there is no dirt on the touch fields.
F908 - the oven system cannot connect with the control panel.	Turn the oven off and on.

12.3 Service data

If you cannot find a solution to the problem yourself, contact your dealer or an Authorised Service Centre.

The necessary data for the service centre is on the rating plate. The rating plate is on the front frame of the oven cavity. Do not remove the rating plate from the oven cavity.

We recommend that you write the data here:	
Model (MOD.)
Product number (PNC)
Serial number (S.N.)

13. ENERGY EFFICIENCY

13.1 Energy saving

 The oven has features which help you save energy during everyday cooking.
--

MENU STRUCTURE

Make sure that the oven door is closed when the oven operates. Do not open the oven door too often during cooking. Keep the door gasket clean and make sure it is well fixed in its position. When possible, do not preheat the oven before cooking.

Keep breaks between baking as short as possible when you prepare a few dishes at one time.

Cooking with the lamp off

Turn off the lamp during cooking. Turn it on only when you need it.

14. MENU STRUCTURE

14.1 Menu

Press  to open Menu.

Menu item		Application
Favourites		Lists the favourite settings.
Options		To set the oven configuration.
Settings	Setup	To set the oven configuration.
	Service	Shows the software version and configuration.

14.2 Submenu for: Options

Submenu	Application
Light	Turns the lamp on and off.
Child Lock	Prevents accidental activation of the oven. When the option is on, the text "Child Lock" appears on the display when you turn on the oven. To enable the oven use, choose the code letters in the alphabetical order. Access to the timer, the remote operation and the lamp is available with the Child Lock on.
Time indication	Turns the clock on and off.
Digital clock style	Changes the format of the displayed time indication.

14.3 Submenu for: Setup

Submenu	Description
Language	Sets the oven language.
Display brightness	Sets the display brightness.
Key tones	Turns the tone of the touch fields on and off. It is not possible to mute the tone for: ①.
Buzzer volume	Sets the volume of key tones and signals.
Time of day	Sets the current time and date.

14.4 Submenu for: Service

Submenu	Description
Demo mode	Activation / deactivation code: 2468
Software version	Information about software version.
Reset all settings	Restores factory settings.

15. IT'S EASY!

Before first use you have to set:









Language	Display brightness	Key tones	Buzzer volume	Time of day
----------	--------------------	-----------	---------------	-------------

Familiarize yourself with the basic icons on the control panel and the display:



① ON / OFF	☰ Menu	☆ Favourites	🕒 Timer	START / STOP
---------------	-----------	-----------------	------------	--------------

IT'S EASY!

Start using the oven		
MW quick start	Start Microwave at any time with default settings: 30 sec / 1000W.	Press: 



			
heating / cooking 100 - 1000 W	cooking / browning intensity: low / high	cooking / browning	heating liquids 800 - 1000 W
			
reheating 300 - 700 W	defrosting 100 - 200 W	melting 100 - 400 W	preparing popcorn 700 - 1000 W

Settings of the microwave		Microwave tips
Microwave power:	Maximum time:	Cover the food for cooking and reheating. Turn or stir the food halfway through the defrosting and cooking time. Put the spoon to the dish when heating liquids. Put the food into the oven without packaging (only microwave safe).
100 - 600 W	59 min	
> 600 W	7 min	

Start cooking				
Step 1	Step 2	Step 3	Step 4	Step 5
 - press to turn on the oven.	 ... - select the function.	W - set the microwave power.	OK - press to confirm.	START - press to start cooking.

Use quick functions to set the cooking time	
10% Finish assist Use 10% Finish assist to add extra time when 10% of the cooking time is left.	To extend the cooking time press +1min .

16. ENVIRONMENTAL CONCERNS

Recycle materials with the symbol . Put the packaging in relevant containers to recycle it. Help protect the environment and human health by recycling waste of electrical and electronic appliances. Do not dispose of appliances marked with the symbol  with the household waste. Return the product to your local recycling facility or contact your municipal office.

CONTENIDO

PARA UNOS RESULTADOS PERFECTOS

Gracias por elegir este producto AEG. Lo hemos creado para brindarle un rendimiento impecable durante muchos años, con tecnologías innovadoras que lo ayudan a simplificar la vida, características que quizás no encuentre en los electrodomésticos comunes. Dedique unos minutos a leer este documento para sacarle el máximo partido.

Visite nuestro sitio web para:



Obtener consejos, folletos, soluciones a problemas e información de servicio y reparación:

www.aeg.com/support



Registrar su producto para recibir un mejor servicio:

www.registreaeg.com



Comprar accesorios, artículos de consumo y piezas de recambio originales para su aparato:

www.aeg.com/shop

ATENCIÓN AL CLIENTE Y SERVICIO

Le recomendamos que utilice recambios originales.

Cuando se ponga en contacto con nuestro Centro de servicio técnico, asegúrese de tener los siguientes datos disponibles: Modelo, código numérico del producto (PNC), número de serie. La información se encuentra en la placa de características.

 Advertencia / Precaución - Información sobre seguridad

 Información general y consejos

 Información relativa al medioambiente

Salvo modificaciones.

CONTENIDO

1. INFORMACIÓN SOBRE SEGURIDAD... 123	3. DESCRIPCIÓN DEL PRODUCTO..... 130
1.1 Seguridad de niños y personas vulnerables..... 123	3.1 Resumen general..... 130
1.2 Instrucciones generales de seguridad..... 124	3.2 Accesorios..... 130
2. INSTRUCCIONES DE SEGURIDAD..... 126	4. CÓMO ENCENDER Y APAGAR EL HORNO..... 130
2.1 Instalación..... 126	4.1 Panel de mandos..... 130
2.2 Conexión eléctrica..... 127	4.2 Pantalla..... 132
2.3 Uso..... 128	5. ANTES DEL PRIMER USO..... 133
2.4 Mantenimiento y limpieza..... 129	5.1 Limpieza inicial 133
2.5 Iluminación interna..... 129	5.2 Primera conexión..... 133
2.6 Asistencia técnica..... 129	6. USO DIARIO..... 133
2.7 Eliminación..... 129	6.1 Cómo ajustar la función: Grill + microondas, Grill..... 133

6.2	Cómo ajustar: Funciones de cocción de microondas.....	135	10.4	Ajustes de potencia recomendados para distintos tipos de alimentos.....	143
6.3	Instrucciones de uso: Inicio rápido del microondas.....	136	10.5	Tablas de cocción para organismos de control.....	144
6.4	Funciones de cocción.....	136	11. MANTENIMIENTO Y LIMPIEZA.....	145	
7. FUNCIONES DEL RELOJ.....	137		11.1	Notas sobre la limpieza.....	145
7.1	Descripción de funciones de reloj	137	12. SOLUCIÓN DE PROBLEMAS.....	146	
7.2	Cómo ajustar: Funciones de reloj	138	12.1	Qué hacer si.....	146
8. INSTRUCCIONES DE USO: ACCESORIOS.....	139		12.2	Cómo administrar: Códigos de error.....	146
8.1	Inserción de accesorios.....	139	12.3	Datos de servicio.....	147
9. FUNCIONES ADICIONALES.....	139		13. EFICACIA ENERGÉTICA.....	147	
9.1	Cómo guardar: Favoritos.....	139	13.1	Ahorro energético.....	147
9.2	Bloqueo función.....	140	14. ESTRUCTURA DEL MENÚ.....	147	
9.3	Ventilador de enfriamiento.....	140	14.1	Menú.....	147
10. CONSEJOS.....	141		14.2	Submenú de: Opciones.....	148
10.1	Recomendaciones de cocción... 141		14.3	Submenú de: Configuración.....	148
10.2	Recomendaciones para microondas	141	14.4	Submenú para: Asistencia.....	149
10.3	Recipientes y materiales adecuados para microondas	142	15. ¡ES FÁCIL!.....	149	
			16. ASPECTOS MEDIOAMBIENTALES.....	150	

1. INFORMACIÓN SOBRE SEGURIDAD

Antes de instalar y utilizar el aparato, lea atentamente las instrucciones facilitadas. El fabricante no se hace responsable de lesiones o daños producidos como resultado de una instalación o un uso incorrectos. Conserve siempre estas instrucciones en lugar seguro y accesible para futuras consultas.

1.1 Seguridad de niños y personas vulnerables

- Este aparato puede ser utilizado por niños de 8 años en adelante y personas cuyas capacidades físicas, sensoriales o mentales estén disminuidas o que carezcan de la experiencia y conocimientos suficientes para manejarlo, siempre que cuenten con las instrucciones o la supervisión sobre el uso del electrodoméstico de forma segura y comprendan los riesgos. Es necesario mantener alejados

del aparato a los niños de menos de 8 años, así como a las personas con minusvalías importantes y complejas, salvo que estén bajo supervisión continua.

- Es necesario vigilar a los niños para que no jueguen con el aparato.
- Mantenga todo el material de embalaje fuera del alcance de los niños y deséchelo de forma adecuada.
- **ADVERTENCIA:** Mantenga a los niños y mascotas alejados del aparato cuando esté funcionando o enfriándose. Las piezas accesibles se calientan durante el funcionamiento.
- Si este aparato tiene un bloqueo de seguridad para niños, debe activarlo.
- La limpieza y mantenimiento de usuario del producto no podrán ser realizados por niños sin supervisión.

1.2 Instrucciones generales de seguridad

- Este aparato está diseñado exclusivamente para cocinar.
- Este aparato está diseñado para uso doméstico en interiores.
- Este aparato se puede utilizar en oficinas, habitaciones de hotel, habitaciones de Bed&Breakfast, casas de campo y otros alojamientos similares donde dicho uso no exceda (en promedio) los niveles de uso doméstico.
- Solo un electricista cualificado puede instalar este aparato y sustituir el cable.
- No utilice el aparato antes de instalarlo en la estructura empotrada.
- Desenchufe el aparato de la red eléctrica antes de realizar tareas de mantenimiento.
- Si el cable de alimentación sufre algún daño, el fabricante, su servicio técnico autorizado o un profesional tendrán que cambiarlo para evitar riesgos.

- **ADVERTENCIA:** Asegúrese de que el aparato está apagado antes de cambiar la bombilla para evitar el riesgo de descarga eléctrica.
- **ADVERTENCIA:** El horno y las piezas accesibles se calientan mucho durante el funcionamiento. Preste mucha atención para no tocar las resistencias.
- Utilizar siempre guantes o manoplas para horno para retirar o introducir accesorios o recipientes.
- Utilice únicamente el plato giratorio y el soporte del el plato giratorio diseñado para este aparato.
- No active la función de microondas cuando el aparato esté vacío. Las piezas metálicas en el interior de la cavidad pueden generar arco eléctrico.
- No se pueden utilizar contenedores metálicos de alimentos y bebidas durante la cocción con microondas. Este requisito no se aplica si el fabricante especifica el tamaño y la forma de los contenedores metálicos apropiados para cocción con microondas.
- **ADVERTENCIA:** Si la puerta o los cierres de la puerta sufren daños, no debe operar el aparato hasta que una persona cualificada lo haya reparado.
- **ADVERTENCIA:** Solo una persona cualificada puede realizar tareas de reparación o mantenimiento que impliquen la extracción de una tapa que protege contra la exposición a la energía del microondas.
- **ADVERTENCIA:** No caliente líquidos ni otros alimentos en recipientes herméticos. Podrían explotar.
- Utilice solamente utensilios aptos para hornos de microondas.
- Cuando caliente alimentos en recipientes de papel o plástico, vigile el aparato por la posibilidad de incendio.
- El aparato está diseñado para calentar alimentos y bebidas. El secado de alimentos o ropa y el calentamiento de almohadillas térmicas, pantuflas, esponjas, trapos húmedos

INSTRUCCIONES DE SEGURIDAD

y similares pueden provocar riesgo de lesiones, ignición o incendio.

- Si se genera humo, apague o desenchufe el aparato y deje la puerta cerrada para sofocar las posibles llamas.
- El calentamiento de bebidas en el microondas puede provocar un hervido brusco y lento. Extreme la precaución cuando manipule los recipientes.
- Se agitará o removerá el contenido de los biberones y de los tarros de comida para bebés y se controlará la temperatura antes de consumirlos para evitar quemaduras.
- Los huevos con cáscara y los huevos duros enteros no deben calentarse en el aparato, ya que pueden explotar, incluso después de que haya terminado el calentamiento en el microondas.
- Limpie el aparato con regularidad y elimine los restos de comida.
- No utilice un limpiador a vapor para limpiar el aparato.
- No utilice productos de limpieza abrasivos ásperos ni rascadores de metal afilado para limpiar el cristal de las tapas abisagradas de la placa si no quiere arañar su superficie, lo que podría hacer que el cristal se hiciese añicos.
- Si no se mantiene el aparato en condiciones limpias, la superficie podría deteriorarse y afectar negativamente a la vida útil del aparato y provocar situaciones de riesgo.

2. INSTRUCCIONES DE SEGURIDAD

2.1 Instalación

**ADVERTENCIA!**

Sólo un técnico cualificado puede instalar el aparato.

- Retire todo el embalaje.
- No instale ni utilice un aparato dañado.
- Siga las instrucciones de instalación suministradas con el aparato.
- Tenga cuidado al mover el aparato, porque es pesado. Utilice siempre guantes de protección y calzado cerrado.
- No tire nunca del aparato sujetando el asa.

INSTRUCCIONES DE SEGURIDAD

- Instale el aparato en un lugar seguro y adecuado que cumpla los requisitos de instalación.
- Respete siempre la distancia mínima entre el aparato y los demás electrodomésticos y mobiliario.
- Antes de montar el aparato, compruebe si la puerta del horno se abre sin limitaciones.
- El aparato está equipado con un sistema de refrigeración eléctrica. Debe utilizarse con la fuente de alimentación eléctrica.
- La unidad empotrada debe cumplir los requisitos de estabilidad de la norma DIN 68930.

Altura mínima del armario (Altura mínima del armario debajo de la encimera)	444 (460) mm
Ancho del armario	560 mm
Profundidad del armario	550 (550) mm
Altura de la parte frontal del aparato	455 mm
Altura de la parte trasera del aparato	440 mm
Anchura de la parte frontal del aparato	595 mm
Anchura de la parte trasera del aparato	559 mm
Fondo del aparato	567 mm
Fondo empotrado del aparato	546 mm
Fondo con la puerta abierta	882 mm
Tamaño mínimo de la abertura de ventilación. Abertura situada en la parte trasera inferior	560x20 mm
Longitud del cable de alimentación. El cable está en la esquina derecha de la parte trasera	1500 mm
Tornillos de montaje	3.5x25 mm

2.2 Conexión eléctrica



ADVERTENCIA!

Riesgo de incendios y descargas eléctricas.

- Todas las conexiones eléctricas deben realizarlas electricistas cualificados.
- El aparato debe conectarse a tierra.
- Asegúrese de que los parámetros de la placa de características son compatibles con los valores eléctricos del suministro eléctrico.
- Utilice siempre una toma con aislamiento de conexión a tierra correctamente instalada.
- No utilice adaptadores de enchufes múltiples ni cables prolongadores.

INSTRUCCIONES DE SEGURIDAD

- Asegúrese de no provocar daños en el enchufe ni en el cable de red. Si es necesario cambiar el cable de alimentación del aparato, debe hacerlo el centro de servicio técnico autorizado.
- Evite que el cable de red toque o entre en contacto con la puerta del aparato o con el hueco por debajo del aparato, especialmente mientras funciona o si la puerta está caliente.
- Los mecanismos de protección contra descargas eléctricas de componentes con corriente y aislados deben fijarse de forma que no puedan aflojarse sin utilizar herramientas.
- Conecte el enchufe a la toma de corriente únicamente cuando haya terminado la instalación. Asegúrese de tener acceso al enchufe del suministro de red una vez finalizada la instalación.
- Si la toma de corriente está floja, no conecte el enchufe.
- No desconecte el aparato tirando del cable de conexión a la red. Tire siempre del enchufe.
- Use únicamente dispositivos de aislamiento apropiados: línea con protección contra los cortocircuitos, fusibles (tipo tornillo que puedan retirarse del soporte), dispositivos de fuga a tierra y contactores.
- La instalación eléctrica debe tener un dispositivo de aislamiento que permita desconectar el aparato de todos los polos de la red. El dispositivo de aislamiento debe tener una apertura de contacto con una anchura mínima de 3 mm.
- El aparato se suministra con enchufe y cable de red.

2.3 Uso



ADVERTENCIA!

Riesgo de lesiones, quemaduras y descargas eléctricas o explosiones.

- No cambie las especificaciones de este aparato.
- Asegúrese de que las aberturas de ventilación no están bloqueadas.
- No deje el aparato desatendido durante el funcionamiento.
- Apague el aparato después de cada uso.
- Tenga cuidado al abrir la puerta del aparato mientras funciona. Puede liberarse aire caliente.
- No utilice el aparato con las manos mojadas ni con agua en contacto.
- No ejerza presión sobre la puerta abierta.
- No utilice el aparato como superficie de trabajo ni para depositar objetos.
- Abra la puerta del aparato con cuidado. El uso de ingredientes con alcohol puede provocar una mezcla de alcohol y aire.
- No deje que las chispas ni las llamas abiertas entren en contacto con el aparato cuando abra la puerta.
- No coloque productos inflamables o artículos mojados con productos inflamables dentro, cerca o sobre el aparato.
- No utilice la función de microondas para precalentar el horno.



ADVERTENCIA!

Podría dañar el aparato.

- Para evitar daños o decoloraciones en el esmalte:
 - no coloque papel de aluminio directamente en la parte inferior del interior del aparato.
 - no ponga agua directamente en el aparato caliente.
 - no deje platos húmedos ni alimentos en el aparato una vez finalizada la cocción.
 - tenga cuidado al retirar o instalar los accesorios.
- La pérdida de color del esmalte o el acero inoxidable no afecta al rendimiento del aparato.

- Cocina siempre con la puerta del aparato cerrada.
- Si el aparato se instala detrás de un panel de un mueble (por ejemplo una puerta) asegúrese de que la puerta nunca esté cerrada mientras funciona el aparato. El calor y la humedad pueden acumularse detrás de un panel del armario cerrado y provocar daños al aparato, el alojamiento o el suelo. No cierre del panel del armario hasta que el aparato se haya enfriado completamente después de su uso.

2.4 Mantenimiento y limpieza



ADVERTENCIA!

Existe riesgo de lesiones, incendios o daños al aparato.

- Antes de proceder con el mantenimiento, apague el aparato y desconecte el enchufe de la red.
- Asegúrese de que el aparato esté frío. Los paneles de cristal pueden romperse.
- Cambie inmediatamente los paneles de cristal de la puerta que estén dañados. Póngase en contacto con el servicio técnico autorizado.
- Tenga cuidado al desmontar la puerta del aparato. ¡La puerta es muy pesada!
- Asegúrese de que el interior, el plato giratorio y la puerta se secan después de cada uso. El vapor producido durante el funcionamiento del aparato se condensa en las paredes de la cavidad y puede provocar corrosión.
- Limpie periódicamente el aparato para evitar el deterioro del material de la superficie.
- Los restos de comida o grasa en el interior del aparato podrían provocar un incendio y arcos eléctricos cuando se utiliza la función de microondas.
- Limpie el aparato con un paño suave humedecido. Utilice solo detergentes neutros. No utilice productos abrasivos, estropajos duros, disolventes ni objetos metálicos.
- Si utiliza aerosoles de limpieza para hornos, siga las instrucciones de seguridad del envase.

2.5 Iluminación interna



ADVERTENCIA!

Riesgo de descarga eléctrica.

- En cuanto a la(s) bombilla(s) de este producto y las de repuesto vendidas por separado: Estas bombillas están destinadas a soportar condiciones físicas extremas en los aparatos domésticos, como la temperatura, la vibración, la humedad, o están destinadas a señalar información sobre el estado de funcionamiento del aparato. No están destinadas a utilizarse en otras aplicaciones y no son adecuadas para la iluminación de estancias domésticas.
- Este producto contiene una fuente luminosa de la clase de eficiencia energética G.
- Utilice solo bombillas de las mismas características .

2.6 Asistencia técnica

- Para reparar el aparato, póngase en contacto con el centro de servicio autorizado.
- Utilice solamente piezas de recambio originales.

2.7 Eliminación



ADVERTENCIA!

Existe riesgo de lesiones o asfixia.

- Contacte con las autoridades locales para saber cómo desechar correctamente el aparato.
- Desconecte el aparato de la red.

DESCRIPCIÓN DEL PRODUCTO

- Corte el cable eléctrico cerca del aparato y deséchelo.
- Retire el pestillo de la puerta para evitar que los niños o las mascotas queden atrapados en el aparato.

3. DESCRIPCIÓN DEL PRODUCTO

3.1 Resumen general

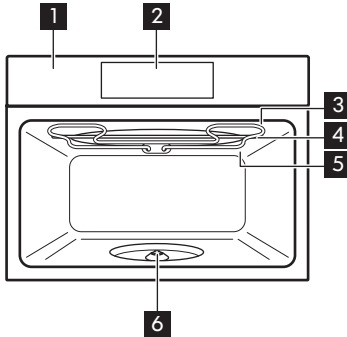

- 1** Panel de mandos
- 2** Pantalla
- 3** Resistencia
- 4** Generador de microondas
- 5** Bombilla

- 6** Eje del plato giratorio

3.2 Accesorios

Set de Turntable
Para preparar comida.

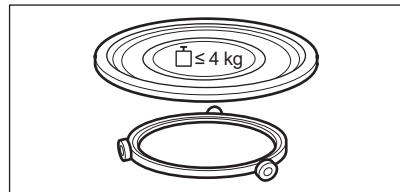

Rejilla para grill
Para utilizar el grill.

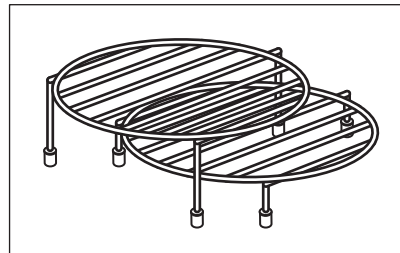



4. CÓMO ENCENDER Y APAGAR EL HORNO

4.1 Panel de mandos

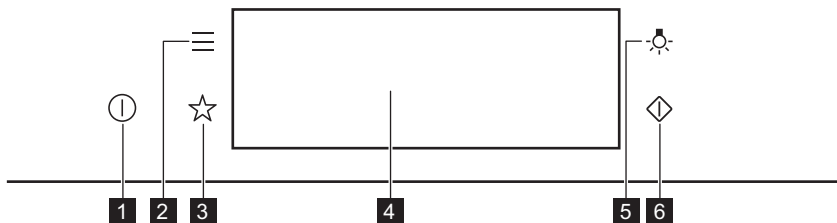
CÓMO ENCENDER Y APAGAR EL HORNO









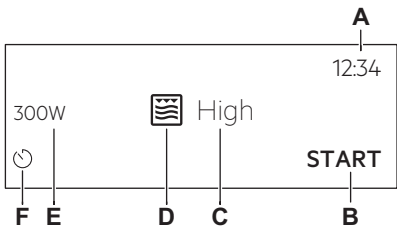
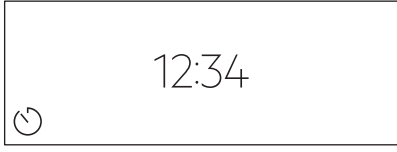

1	Encendido/ON / Apagado/OFF	Mantenga pulsado para encender y apagar el horno.
2	Menú	Enumera las funciones del horno.
3	Favoritos	Muestra los ajustes favoritos.
4	Pantalla	Muestra los ajustes actuales del horno.
5	Interruptor de la lámpara	Enciende y apaga la luz.
6	Inicio rápido del microondas	Para activar la función de microondas (1000 W y 30 segundos).

 <p>Pulse el botón</p>	 <p>Mover</p>	 <p>Mantener pulsado</p>
<p>Touchar a superfície com a ponta de los dedos.</p>	<p>Deslizar la punta del dedo sobre la superficie.</p>	<p>Touchar a superfície durante 3 segundos.</p>

CÓMO ENCENDER Y APAGAR EL HORNO

4.2 Pantalla

	<p>Después de encenderse, la pantalla muestra la pantalla principal con la función y la intensidad predeterminada del grill.</p> <p>A. Hora B. INICIO/PARAR C. Intensidad del grill D. Funciones de cocción E. Potencia del Microondas F. Temporizador</p>
	<p>Si no usa el horno durante 2 minutos, la pantalla pasa al modo de espera.</p>
	<p>Durante el cocinado, la pantalla muestra las funciones seleccionadas y otras opciones disponibles.</p>

<h3>Indicadores de pantalla</h3>			
<p>Indicadores básicos - para navegar por la pantalla.</p>			
<p>OK Para confirmar la selección o el ajuste.</p>	<p> Para retroceder un nivel en el menú.</p>	<p> Para deshacer la última acción.</p>	<p> Para activar y desactivar las opciones.</p>
<p>Sonar la alarma indicadores de función - cuando finaliza el tiempo de cocción seleccionado, suena una señal acústica.</p>			
<p> La función está activada.</p>	<p> La función está activada. La cocción se detiene automáticamente.</p>	<p> El sonido de la alarma está apagado.</p>	
<h3>Indicadores de temporizador</h3>			



Para ajustar la función: Inicio retardado.



Para cancelar el ajuste.

5. ANTES DEL PRIMER USO



ADVERTENCIA!

Consulte los capítulos sobre seguridad.

5.1 Limpieza inicial

<p>Paso 1</p>	<p>Paso 2</p>	<p>Paso 3</p>
<p>Retire todos los accesorios del horno.</p>	<p>Limpie el horno y los accesorios con un paño suave humedecido en agua templada y jabón neutro.</p>	<p>Coloque los accesorios en el horno.</p>

5.2 Primera conexión

La pantalla muestra un mensaje de bienvenida después de la primera conexión. Debe ajustar: Idioma, Brillo de la pantalla, Tono de teclas, Volumen del timbre, Hora.

6. USO DIARIO



ADVERTENCIA!

Consulte los capítulos sobre seguridad.

6.1 Cómo ajustar la función: Grill + microondas, Grill

El horno puede hacer ruidos cuando se utiliza la función: Grill + microondas. Son normales para esta función.

Ajuste de la función: Grill + microondas	
<p>Paso 1</p>	<p>Introduzca la rejilla para grill baja.</p>
<p>Paso 2</p>	<p>Encienda el horno. La pantalla muestra la función de cocción por defecto.</p>
<p>Paso 3</p>	<p>Pulse el símbolo de la función de cocción para entrar en el submenú.</p>

USO DIARIO

Ajuste de la función: Grill + microondas	
Paso 4	Seleccione la función:  . Pulse: OK.
Paso 5	Seleccione el nivel de intensidad del grill.
Función	Nivel de intensidad del grill
Lo	Bajo
Hi	Alto
Paso 6	Pulse: OK.
Paso 7	Pulse: START .
STOP - pulse para apagar el horno.	
Paso 8	Apague el horno.

La potencia de microondas está limitada a 500 W cuando se utiliza la función: Grill + microondas.

Ajuste de la función: Grill	
Paso 1	Inserte el soporte de grill alto.
Paso 2	Encienda el horno. La pantalla muestra la función de cocción por defecto.
Paso 3	Pulse el símbolo de la función de cocción para entrar en el submenú.
Paso 4	Seleccione la función:  . Pulse: OK.
Paso 5	Seleccione el nivel de intensidad del grill.
Función	Nivel de intensidad del grill
Lo	Bajo
Hi	Alto
Paso 6	Pulse: OK.

Ajuste de la función: Grill	
Paso 7	Pulse: START .
STOP - pulse para desactivar la función.	
Paso 8	Apague el horno.

6.2 Cómo ajustar: Funciones de cocción de microondas

Paso 1	Encienda el horno.
Paso 2	Pulse el símbolo de la función de cocción para entrar en el submenú.
Paso 3	Seleccione la función de cocción del microondas y pulse: OK. La pantalla muestra: potencia del microondas.
Paso 4	Ajuste: potencia del microondas. Pulse: OK.
Paso 5	Pulse: START .
STOP - pulse para desactivar la función.	
Paso 6	Apague el horno.

El tiempo máximo de las funciones del microondas dependerá de la potencia del microondas fijada:

POTENCIA DEL MICROONDAS	TIEMPO MÁXIMO
100 - 600 W	59 minutos.
Más de 600 W	7 minutos

 Si abre la puerta, se detiene la función. Para volver a iniciarlo, pulse START

¡Tome un atajo!



6.3 Instrucciones de uso: Inicio rápido del microondas





Paso 1	Mantenga pulsada: . El microondas funcionará durante 30 segundos.	
Paso 2	Para prolongar el tiempo de cocción:	
	Pulse en el valor del tiempo de funcionamiento para ir al control de tiempo. Ajuste el tiempo de cocción.	Pulse +30 s.
El microondas se puede encender en cualquier momento con: Inicio rápido del microondas.		

6.4 Funciones de cocción

ESTÁNDAR

Función de cocción	Aplicación
 Grill	Para asar al grill alimentos de poco espesor y tostar pan.
 Grill + microondas	Para cocinar la comida en poco tiempo y dorarla. Puede ajustar 2 niveles de intensidad del grill: bajo y alto.
 Microondas	Calentamiento, cocción, potencia: 100 - 1.000 W

MICROONDAS

Función de cocción	Aplicación
 Descongelar	Descongelar carne, pescado, pasteles, potencia: 100 - 200 W
 Derritiendo	Fundir chocolate y mantequilla, rango de potencia: 100 - 400 W
 Recalentar	Calentar comidas preparadas y delicadas, rango de potencia: 300 - 700 W
 Palomitas de maíz	Preparación de palomitas de maíz, rango de potencia: 700 - 1.000 W
 Líquido	Calentar bebidas y sopas, potencia: 800 - 1.000 W

7. FUNCIONES DEL RELOJ

7.1 Descripción de funciones de reloj

Función de reloj	Aplicación
Tiempo de cocción	Para ajustar la duración de la cocción. El máximo es 23 h 59 min.
Finalizar acción	Para ajustar lo que ocurre al finalizar el temporizador.
Añadir tiempo	Para ampliar el tiempo de cocción.
Avisador	Para ajustar una cuenta atrás. El máximo es 23 h 59 min. Esta función no influye en el funcionamiento del horno.
Tiempo de funcionamiento	Controla el tiempo que está activa la función. Tiempo de funcionamiento - puede encenderla y apagarla.

7.2 Cómo ajustar: Funciones de reloj

Cómo ajustar el reloj	
Paso 1	Pulse: Hora.
Paso 2	Ajuste la hora. Pulse: OK.

Cómo programar el tiempo de cocción	
Paso 1	Seleccione la función de cocción.
Paso 2	Pulse:  .
Paso 3	Ajuste la hora. Pulse: OK.

Cómo elegir la opción de final	
Paso 1	Seleccione la función de cocción.
Paso 2	Pulse:  .
Paso 3	Ajuste el tiempo de cocción.
Paso 4	Pulse: ● ● ● .
Paso 5	Pulse: Finalizar acción.
Paso 6	Elija el que prefiera: Finalizar acción.
Paso 7	Pulse: OK. Repita la acción hasta que la pantalla muestre la pantalla principal.

Cómo prolongar el tiempo de cocción	
Cuando queda el 10% del tiempo de cocción y parece que la comida no está lista, puede extender el tiempo de cocción. También puede cambiar la función de cocción.	
Para prolongar el tiempo de cocción, pulse +1min .	

INSTRUCCIONES DE USO: ACCESORIOS

Cómo cambiar los ajustes del temporizador

Paso 1 Pulse: 

Paso 2 Ajuste el valor del temporizador.

Paso 3 Pulse: OK.

Puede cambiar el tiempo ajustado durante la cocción en cualquier momento.

8. INSTRUCCIONES DE USO: ACCESORIOS

8.1 Inserción de accesorios

Utilice únicamente utensilios y materiales adecuados. Consulte los recipientes y materiales adecuados para microondas en el capítulo “Consejos”.

Set de Turntable:

Siempre cocine los alimentos en el plato giratorio.

Coloque la guía de rodillo alrededor del eje giratorio. Coloque la bandeja de cristal giratoria sobre la guía de rodillos.

Utilice únicamente el plato giratorio suministrado con el aparato.

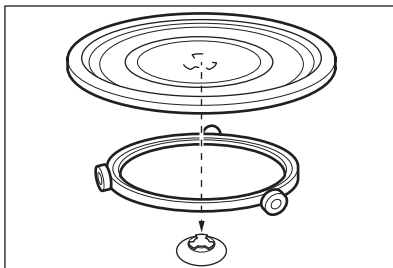

Rejilla para grill:

Coloque la parrilla con las tapas de silicona apoyadas en el plato giratorio.

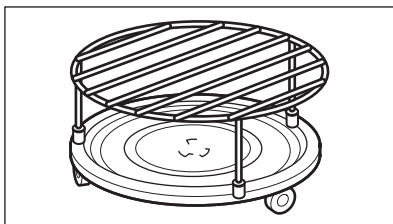



9. FUNCIONES ADICIONALES

9.1 Cómo guardar: Favoritos



Puede guardar sus ajustes favoritos, como la función de cocción, el tiempo de cocción, la temperatura o la función de limpieza. Puede guardar 3 ajustes favoritos.

FUNCIONES ADICIONALES

Paso 1	Encienda el horno.
Paso 2	Seleccione los ajustes preferidos.
Paso 3	Pulse:  . Seleccione: Favoritos.
Paso 4	Seleccione: Guardar los ajustes actuales.
Paso 5	Pulse + para añadir el ajuste a la lista de: Favoritos. Pulse OK.
 - pulse para restablecer el ajuste.  - pulse para cancelar el ajuste.	

9.2 Bloqueo función

Esta función impide que se produzca accidentalmente un cambio de la función de cocción.

Paso 1	Encienda el horno.
Paso 2	Seleccione una función de cocción.
Paso 3	 ,  - pulse al mismo tiempo para activar la función.
Para desactivar la función, repita el paso 3.	

9.3 Ventilador de enfriamiento

Cuando el horno funciona, el ventilador de enfriamiento se pone en marcha automáticamente para mantener frías las superficies del horno. Una vez apagado el horno, el ventilador sigue funcionando hasta enfriarlo totalmente.

10. CONSEJOS

10.1 Recomendaciones de cocción



La temperatura y los tiempos de cocción de las tablas son meramente orientativos. Dependen de las recetas y de la calidad y cantidad de los ingredientes utilizados.

El comportamiento de su horno puede ser diferente al del que tenía anteriormente. Las siguientes sugerencias muestran las funciones de cocción y los ajustes recomendados de tiempo de cocción para tipos de alimentos concretos.

Si no encuentra los ajustes para una receta especial, busque otra similar.

Para más recomendaciones de cocina, consulte las tablas de cocción en nuestro sitio web. Para encontrar los consejos de cocción, compruebe el número de PNC de la placa de datos del marco frontal del interior del horno.

10.2 Recomendaciones para microondas

¡A cocinar!

No ponga recipientes directamente sobre la base del horno. Utilice siempre los utensilios de cocina adecuados para microondas.

Coloque el utensilio de cocina en el centro de la zona seleccionada.

El contacto con elementos demasiado calientes o demasiado fríos puede romper el plato giratorio.

Remueva o de la vuelta a la comida a la mitad del tiempo de cocción o descongelación.

Remueva de vez en cuando los platos líquidos.

Remueva la comida antes de servirla.

Tape la comida para cocinar y recalentar.

Coloque la cuchara en la botella o el vaso al calentar bebidas para asegurar una mejor distribución del calor.

Coloque los alimentos en el horno sin ningún envoltorio. Las comidas envasadas solo pueden introducirse en el microondas si su embalaje es apto para microondas (consulte la información en el embalaje).



Cocción por microondas

Cocine la comida tapada. Cocine alimentos sin tapar solamente si desea un resultado crujiente.

No recocine los platos ajustando una potencia y un tiempo demasiado elevados. La comida puede secarse, quemarse o provocar fuego.

No utilice el horno para cocinar huevos o caracoles con la cáscara, ya que pueden estallar.

Perfore la yema de los huevos fritos antes de recalentarlos.

Perfore la piel de los alimentos varias veces con un tenedor antes de cocinarlos.

Corte las verduras en trocitos de igual tamaño.

Después de apagar el horno, saque los alimentos y déjelo reposar unos minutos para que el calor se distribuya uniformemente.



Descongelación en el microondas

Coloque el alimento congelado sin desenvolver en un plato pequeño vuelto del revés con un contenedor debajo o en una bandeja de descongelación o tamiz de plástico para que el líquido de descongelación pueda salir.





Retire las piezas después de descongeladas.



Para cocinar frutas y verduras sin descongelarlas primero puede utilizar una potencia superior del microondas.

10.3 Recipientes y materiales adecuados para microondas

Para el microondas, utilice solo utensilios y materiales adecuados. Consulte la tabla siguiente como referencia.



Compruebe los utensilios de cocina / especificación de materiales antes de utilizarlo.







Material del utensilio de cocina				
Cristal y porcelana para horno sin componentes de metal, p. ej., vidrio térmico	✓	✓	✓	✓
Vidrio y porcelana no aptos para horno sin plata, oro, platino ni decoraciones de metal	✓	X	X	X
Cristal y vitrocerámica de material apto para horno y congelación	✓	✓	✓	✓
Cerámica y barro sin cuarzo ni componentes metálicos, o vidriado que contenga metales	✓	✓	X	X
Cerámica, porcelana o barro cocido con fondo sin vidriar o con pequeños orificios, p. ej., en las asas	X	X	X	X
Plástico resistente al calor hasta 200 °C	✓	✓	X	X
Cartón, papel	✓	X	X	X
Película de cocción	✓	X	X	X



Material del utensilio de cocina				
Film para asado con cierre apto para microondas	✓	✓	X	X
Fuentes de metal, como esmalte o hierro fundido	X	X	✓	X
Moldes, barniz negro o revestimiento de silicona	X	X	✓	X
Utensilios para microondas, p.ej., Crostino	X	✓	X	X
Rejilla para grill	X	X	✓	✓





10.4 Ajustes de potencia recomendados para distintos tipos de alimentos

Los datos de la tabla son valores orientativos.

800 - 1000 W	
 Sofreír al inicio del proceso de cocción	 calentar líquidos

500 - 700 W					
 Cocinar verduras	 Cocinar platos de huevos	 Estofados a fuego lento	 Cocer arroz	 Calentar platos únicos	 Descongelar y calentar platos congelados





300 - 400 W		
 Fundir queso, chocolate, mantequilla	 Cocinar / calentar alimentos delicados	 Continuar cocinando

100 - 200 W				
 Calentar alimentos infantiles	 Descongelar pan	 Descongelar fruta y pasteles	 Descongelar queso, nata, mantequilla	 Descongelar carne, pescado





10.5 Tablas de cocción para organismos de control

Información para institutos de pruebas

Pruebas realizadas de conformidad con IEC 60705.

FUNCIÓN MICROONDAS	 POWER (A)	 (kg)		 (min)	
Bizcocho	600	0.475	Plato giratorio	5 - 7	-
Pastel de carne	500	0.9	Set de Turntable	18 - 20	-
Pudding de huevo	500	1	Plato giratorio	15 - 17	-
Descongelar carne	200	0.5	Plato giratorio	8 - 9	-

Use la función: Grill microondas.
Use la rejilla para grill baja.

FUNCIÓN DE COMBI MICROONDAS	 POWER (A)	 Nivel de intensidad del grill	 (min)	
Patatas gratinadas, 1,1 kg	300	bajo	30 - 35	-
Pollo, 1,1 kg	300	alto	30 - 35	Coloque la carne en un recipiente de cristal redondo.

11. MANTENIMIENTO Y LIMPIEZA



ADVERTENCIA!

Consulte los capítulos sobre seguridad.

11.1 Notas sobre la limpieza



Agentes limpiadores

Limpie la parte delantera del horno con un paño suave humedecido en agua templada y jabón suave.

Utilice un producto de limpieza para limpiar las superficies metálicas.

Limpie las manchas con un detergente suave.



Uso diario

Limpie el interior después de cada uso. La acumulación de grasa u otros residuos puede provocar un incendio. Retire los residuos de alimentos y la grasa de la bóveda del horno.

No guarde la comida en el horno más de 20 minutos. Seque el interior con un paño suave después de cada uso.



Accesorios

Limpie todos los accesorios después de cada uso y déjelos secar. Antes de limpiar, espere hasta que la superficie giratoria esté fría. El plato puede romperse. Use un paño suave humedecido en agua caliente y detergente suave. No lave los accesorios en el lavavajillas.

No limpie los accesorios no adherentes utilizando un limpiador abrasivo ni objetos afilados.

12. SOLUCIÓN DE PROBLEMAS



ADVERTENCIA!

Consulte los capítulos sobre seguridad.

12.1 Qué hacer si...



El horno no se enciende o no se calienta



Posible causa



Solución

El horno no está conectado a un suministro eléctrico o está mal conectado.

Compruebe si el horno se ha conectado correctamente a la red eléctrica.

El reloj no está ajustado.

Ajuste el reloj, para más detalles consulte el capítulo, "Funciones del reloj", Cómo ajustar: Funciones de reloj.

La puerta no está bien cerrada.

Cierre la puerta del aparato completamente.

Ha saltado el fusible.

Compruebe si el fusible es la causa del problema. Si el problema persiste, póngase en contacto con un electricista cualificado.

El bloqueo de seguridad del horno está activado.

Consulte el capítulo "Menú", submenú: Opciones.



Componentes



Descripción



Solución

La bombilla se ha fundido.



Sustituya la bombilla, para más detalles consulte el capítulo "Mantenimiento y limpieza", Cómo cambiar: Bombilla.

El conjunto de plato giratorio hace ruido.

Hay restos de comida debajo del plato giratorio.

12.2 Cómo administrar: Códigos de error

Cuando se produce el error de software, la pantalla muestra un mensaje de error. En esta sección, encontrará la lista de los problemas que puede manejar por su cuenta.

 Código y descripción	 Solución
F240, F439: los campos táctiles de la pantalla no funcionan correctamente.	Limpie la superficie de la pantalla. Asegúrese de que no haya suciedad en los campos táctiles.
F908: el sistema del horno no puede conectarse con el panel de mandos.	Apague y vuelva a encender el horno.

12.3 Datos de servicio

Si no logra subsanar el problema, póngase en contacto con su distribuidor o un centro de servicio técnico autorizado.

Los datos que necesita para el Centro de servicio técnico se encuentran en la placa de características. La placa de características se encuentra en el marco delantero del interior del horno. No retire la placa de características de la cavidad del horno.

Se recomienda escribir los datos aquí:	
Modelo (MOD):
Número de producto (PNC)
Número de serie (S.N.)

13. EFICACIA ENERGÉTICA

13.1 Ahorro energético

 El horno tiene características que le ayudan a ahorrar energía durante la cocina de cada día.

Asegúrese de que la puerta del horno está cerrada cuando el horno funciona. No abra la puerta del horno muchas veces durante la cocción. Mantenga limpia la junta de la puerta y asegúrese de que está bien fijada en su posición.

En la medida de lo posible, no precaliente el horno antes de cocinar.

Reduzca al máximo el tiempo entre horneados cuando prepare varios platos de una vez.

Cocción con la bombilla apagada

Apague la luz mientras cocina. Enciéndala únicamente cuando la necesite.

14. ESTRUCTURA DEL MENÚ

14.1 Menú

Pulse  para abrir el Menú.

ESTRUCTURA DEL MENÚ

Elemento del menú		Aplicación
Favoritos		Muestra los ajustes favoritos.
Opciones		Para programar la configuración del horno.
Ajustes	Configuración	Para programar la configuración del horno.
	Asistencia	Muestra la configuración y la versión del software.

14.2 Submenú de: Opciones

Submenú	Aplicación
Luz	Enciende y apaga la luz.
Bloqueo de seguridad	Evita la activación accidental del horno. Con esta opción activada, en la pantalla aparece "Bloqueo de seguridad" cuando se enciende el horno. Para activar el uso del horno, seleccione las letras del código en orden alfabético. Acceda al temporizador, el funcionamiento remoto y la lámpara está disponible con el bloqueo de seguridad para niños activado.
Indicación tiempo	Enciende y apaga el reloj.
Opción de hora digital	Cambia el formato de la indicación de tiempo mostrada.

14.3 Submenú de: Configuración

Submenú	Descripción
Idioma	Ajusta el idioma del horno.
Brillo de la pantalla	Ajusta el brillo de la pantalla.
Tono de teclas	Activa y desactiva el tono de los campos táctiles. No es posible silenciar el tono de: ①.





Submenú	Descripción
Volumen del timbre	Ajusta el volumen de los tonos y señales de las teclas.
Hora	Ajusta la hora y la fecha actuales.

14.4 Submenú para: Asistencia





Submenú	Descripción
Modo demostración	Código de activación/desactivación: 2468
Versión del software	Información sobre versión de software.
Restaurar todos los ajustes	Restaura los ajustes de fábrica.





15. ¡ES FÁCIL!

Antes del primer uso, debe ajustar:				
Idioma	Brillo de la pantalla	Tono de teclas	Volumen del timbre	Hora



Familiarícese con los iconos básicos del panel de control y la pantalla:				
 Encendido/ON / Apagado/OFF	 Menú	 Favoritos	 Temporizador	START / STOP

Empiece a usar el horno		
Inicio rápido del microondas	Inicie el microondas en cualquier momento con los ajustes por defecto: 30 segundos / 1000 W.	Pulse: 

			
---	---	---	---



calentar / cocinar 100 - 1.000 W	cocinar / dorar intensidad: baja / alta	cocinar / dorar	calentar líquidos 800 - 1000 W
			
recalentar 300 - 700 W	descongelar 100 - 200 W	derretir 100 - 400 W	hacer palomitas de maíz 700 - 1000 W

Parámetros del microondas		Consejos para microondas
Potencia del microondas:	Tiempo máximo:	Tape la comida para cocinar y recalentar. Remueva o de la vuelta a la comida a la mitad del tiempo de cocción o descongelación. Ponga la cuchara en el plato al calentar líquidos. Introduzca la comida en el horno sin envoltorio (sí que puede utilizar envoltorios seguros para microondas).
100 - 600 W	59 minutos	
> 600 W	7 minutos	

Empezar a cocinar				
Paso 1	Paso 2	Paso 3	Paso 4	Paso 5
 - pulse para encender el horno.	 ... - seleccione la función.	S - ajuste la potencia del microondas.	OK - pulse para confirmar.	START - pulse para iniciar la cocción.

Use las funciones rápidas para ajustar el tiempo de cocción	
Asistente de acabado 10 % Use el Asistente de acabado 10 % para añadir tiempo extra cuando quede un 10 % del tiempo de cocción.	Para prolongar el tiempo de cocción, pulse +1min.

16. ASPECTOS MEDIOAMBIENTALES

Recicle los materiales con el símbolo . Coloque el material de embalaje en los contenedores adecuados para su reciclaje. Ayude a proteger el medio ambiente y la salud pública, así como a reciclar residuos de aparatos eléctricos y electrónicos. No deseche los aparatos marcados con el símbolo  junto con los residuos domésticos. Lleve el producto a su centro de reciclaje local o póngase en contacto con su oficina municipal.

POUR DES RÉSULTATS PARFAITS

Merci d'avoir choisi ce produit AEG. Nous l'avons conçu pour qu'il vous offre des performances irréprochables pendant de nombreuses années, en intégrant des technologies innovantes vous simplifiant la vie – fonctions que vous ne trouverez peut-être pas sur des appareils ordinaires. Veuillez prendre quelques instants pour lire cette notice afin d'utiliser au mieux votre appareil. Consultez notre site pour :



Obtenir des conseils d'utilisation, des brochures, un dépanneur, des informations sur le service et les réparations :

www.aeg.com/support



Enregistrer votre produit pour un meilleur service :

www.registreaeg.com



Acheter des accessoires, consommables et pièces de rechange d'origine pour votre appareil :

www.aeg.com/shop

SERVICE ET ASSISTANCE À LA CLIENTÈLE

N'utilisez que des pièces de rechange d'origine.
Avant de contacter notre centre de service agréé, assurez-vous de disposer des informations suivantes : Modèle, PNC, numéro de série.
Ces informations figurent sur la plaque signalétique.

 Avertissement/Consignes de sécurité

 Informations générales et conseils

 Informations environnementales

Sous réserve de modifications.

TABLE DES MATIÈRES

1. INFORMATION SUR LA SÉCURITÉ.....	152	3.2 Accessoires.....	159
1.1 Sécurité des enfants et des personnes vulnérables.....	152	4. COMMENT ALLUMER ET ÉTEINDRE LE FOUR.....	160
1.2 Sécurité générale.....	153	4.1 Bandeau de commande.....	160
2. CONSIGNES DE SÉCURITÉ.....	155	4.2 Affichage.....	161
2.1 Installation.....	155	5. AVANT LA PREMIÈRE UTILISATION....	162
2.2 Branchement électrique.....	156	5.1 Nettoyage initial	162
2.3 Utilisation.....	157	5.2 Première connexion.....	162
2.4 Entretien et Nettoyage.....	158	6. UTILISATION QUOTIDIENNE.....	162
2.5 Éclairage interne.....	158	6.1 Comment régler la fonction : Gril + Micro-ondes, Gril.....	163
2.6 Service.....	158	6.2 Comment régler : Modes de cuisson micro-ondes.....	164
2.7 Mise au rebut.....	159		
3. DESCRIPTION DE L'APPAREIL.....	159		
3.1 Vue d'ensemble.....	159		

6.3 Comment utiliser : Départ rapide micro-ondes.....	165	10.5 Tableaux de cuisson pour les instituts de tests.....	173
6.4 Modes de cuisson.....	165	11. ENTRETIEN ET NETTOYAGE.....	174
7. FONCTIONS DE L'HORLOGE.....	166	11.1 Remarques concernant l'entretien.....	174
7.1 Description des fonctions de l'horloge.....	166	12. DÉPANNAGE.....	175
7.2 Comment régler : Fonctions de l'horloge.....	167	12.1 Que faire si.....	175
8. CONSEILS D'UTILISATION : ACCESSOIRES.....	168	12.2 Comment gérer : Codes d'erreur.....	176
8.1 Insertion des accessoires.....	168	12.3 Données de maintenance.....	176
9. FONCTIONS SUPPLÉMENTAIRES.....	169	13. RENDEMENT ÉNERGÉTIQUE.....	177
9.1 Comment sauvegarder : Mes programmes.....	169	13.1 Économie d'énergie.....	177
9.2 Verrouillage des touches.....	169	14. STRUCTURE DES MENUS.....	177
9.3 Ventilateur de refroidissement.....	169	14.1 Menu	177
10. CONSEILS.....	170	14.2 Sous-menu pour : Options.....	177
10.1 Recommandations de cuisson... 170		14.3 Sous-menu pour : Configuration	178
10.2 Recommandations pour le micro-ondes	170	14.4 Sous-menu pour : Service.....	178
10.3 Ustensiles de cuisine et matériaux adaptés aux micro-ondes	171	15. C'EST SIMPLE !.....	178
10.4 Réglages recommandés pour différents types d'aliments.....	172	16. EN MATIÈRE DE PROTECTION DE L'ENVIRONNEMENT.....	180

1. INFORMATION SUR LA SÉCURITÉ

Avant d'installer et d'utiliser cet appareil, lisez soigneusement les instructions fournies. Le fabricant ne pourra être tenu pour responsable des blessures et dégâts résultant d'une mauvaise installation ou utilisation. Conservez toujours les instructions dans un lieu sûr et accessible pour vous y référer ultérieurement.

1.1 Sécurité des enfants et des personnes vulnérables

- Cet appareil peut être utilisé par des enfants âgés d'au moins 8 ans et par des personnes ayant des capacités physiques, sensorielles ou mentales réduites ou dénuées d'expérience ou de connaissance, s'ils sont correctement

surveillés ou si des instructions relatives à l'utilisation de l'appareil en toute sécurité leur ont été données et s'ils comprennent les risques encourus. Les enfants de moins de 8 ans et les personnes ayant un handicap très important et complexe doivent être tenus à l'écart de l'appareil, à moins d'être surveillés en permanence.

- Veillez à ce que les enfants ne jouent pas avec l'appareil.
- Ne laissez pas les emballages à la portée des enfants et jetez-les convenablement.
- **AVERTISSEMENT** : tenez les enfants et les animaux éloignés de l'appareil lorsqu'il est en cours de fonctionnement ou lorsqu'il refroidit. Les parties accessibles deviennent chaudes en cours d'utilisation.
- Si l'appareil est équipé d'un dispositif de sécurité enfants, nous vous recommandons de l'activer.
- Le nettoyage et l'entretien par l'utilisateur ne doivent pas être effectués par des enfants sans surveillance.

1.2 Sécurité générale

- Cet appareil est exclusivement destiné à un usage culinaire.
- Cet appareil est conçu pour un usage domestique unique, dans un environnement intérieur.
- Cet appareil peut être utilisé dans les bureaux, les chambres d'hôtel, les chambres d'hôtes, les maisons d'hôtes de ferme et d'autres hébergements similaires lorsque cette utilisation ne dépasse pas le niveau (moyen) de l'utilisation domestique.
- Cet appareil doit être installé et le câble remplacé uniquement par un professionnel qualifié.
- N'utilisez pas l'appareil avant de l'avoir installé dans la structure encastrée.
- Débranchez l'appareil de l'alimentation électrique avant toute opération d'entretien.
- Si le câble d'alimentation secteur est endommagé, son remplacement doit être confié exclusivement au fabricant, à

son service après-vente ou à toute autre personne qualifiée afin d'éviter tout danger électrique.

- **AVERTISSEMENT** : Assurez-vous que l'appareil est éteint avant de remplacer l'ampoule pour éviter tout risque d'électrocution.
- **AVERTISSEMENT** : L'appareil et ses parties accessibles deviennent chauds pendant l'utilisation. Veillez à ne pas toucher les éléments chauffants.
- Utilisez toujours des gants de cuisine pour retirer ou mettre des accessoires ou des plats allant au four.
- Utilisez uniquement le plateau tournant et le support de plateau tournant conçus pour cet appareil.
- N'activez pas la fonction Micro-ondes lorsque l'appareil est vide. Les pièces métalliques à l'intérieur de la cavité peuvent créer un arc électrique.
- Les aliments ou boissons dans des récipients en métal ne doivent jamais être chauffés au micro-ondes. Cet avertissement ne s'applique pas si le fabricant indique la taille et la forme des récipients métalliques adaptés à la cuisson au micro-ondes.
- **AVERTISSEMENT** : Si la porte ou les joints de porte sont endommagés, l'appareil ne doit pas être utilisé tant qu'il n'a pas été réparé par un professionnel qualifié.
- **AVERTISSEMENT** : Toute opération de maintenance ou réparation nécessitant le retrait d'un couvercle assurant la protection contre l'exposition à l'énergie du micro-ondes ne doit être effectuée que par un professionnel qualifié.
- **AVERTISSEMENT** : Ne chauffez pas les liquides et autres aliments dans des récipients scellés. Ils sont susceptibles d'exploser.
- N'utilisez que des ustensiles adaptés à une utilisation dans un four à micro-ondes.
- Lorsque vous faites cuire des aliments dans des récipients en plastique ou en papier, observez l'appareil car ces matières peuvent s'enflammer.

- L'appareil est destiné à chauffer des aliments et des boissons. Le séchage d'aliments ou de vêtements et le réchauffement de coussinets, de chaussons, d'éponges, de linge humide et autres peuvent provoquer des blessures, l'inflammation ou un incendie.
- Si de la fumée est émise, éteignez ou débranchez l'appareil et laissez la porte fermée pour étouffer les flammes.
- Le chauffage au micro-ondes des boissons peut provoquer une ébullition différée. Prenez des précautions lorsque vous manipulez le récipient.
- Le contenu des biberons et des petits pots pour bébés doit être remué ou secoué et la température vérifiée avant de consommer, afin d'éviter tout risque de brûlure.
- Les œufs dans leur coquille et les œufs durs entiers ne doivent pas être réchauffés dans l'appareil car ils pourraient exploser, même après la fin de la cuisson au micro-ondes.
- Nettoyez régulièrement l'appareil et retirez les dépôts alimentaires.
- N'utilisez pas de nettoyeur à vapeur pour nettoyer l'appareil.
- N'utilisez pas de produits abrasifs ni de racloirs pointus en métal pour nettoyer la porte en verre car ils peuvent rayer la surface, ce qui peut briser le verre.
- Si vous ne maintenez pas l'appareil dans des conditions de propreté, il peut entraîner une détérioration de la surface qui pourrait affecter la durée de vie de l'appareil et provoquer une situation dangereuse.

2. CONSIGNES DE SÉCURITÉ

2.1 Installation

**AVERTISSEMENT!**

L'appareil doit être installé uniquement par un professionnel qualifié.

- Retirez l'intégralité de l'emballage.
- N'installez pas et ne branchez pas un appareil endommagé.
- Suivez scrupuleusement les instructions d'installation fournies avec l'appareil.
- Soyez toujours vigilants lorsque vous déplacez l'appareil car il est lourd. Utilisez toujours des gants de sécurité et des chaussures fermées.

CONSIGNES DE SÉCURITÉ

- Ne tirez jamais l'appareil par la poignée.
- Installez l'appareil dans un lieu sûr et adapté répondant aux exigences d'installation.
- Respectez l'espacement minimal requis par rapport aux autres appareils et éléments.
- Avant de monter l'appareil, vérifiez si la porte du four s'ouvre sans retenue.
- L'appareil est équipé d'un système de refroidissement électrique. Il doit être utilisé avec l'alimentation électrique.
- L'unité intégrée doit répondre aux exigences de stabilité de la norme DIN 68930.

Hauteur minimale du meuble (Hauteur minimale du meuble sous le plan de travail)	444 (460) mm
Largeur du meuble	560 mm
Profondeur du meuble	550 (550) mm
Hauteur de l'avant de l'appareil	455 mm
Hauteur de l'arrière de l'appareil	440 mm
Largeur de l'avant de l'appareil	595 mm
Largeur de l'arrière de l'appareil	559 mm
Profondeur de l'appareil	567 mm
Profondeur d'encastrement de l'appareil	546 mm
Profondeur avec porte ouverte	882 mm
Dimensions minimales de l'ouverture de ventilation. Ouverture placée sur la partie inférieure de la face arrière	560x20 mm
Longueur du câble d'alimentation secteur. Le câble est placé dans le coin droit de la face arrière	1500 mm
Vis de montage	3.5x25 mm

2.2 Branchement électrique



AVERTISSEMENT!

Risque d'incendie ou d'électrocution.

- Tous les raccordements électriques doivent être effectués par un électricien qualifié.
- L'appareil doit être relié à la terre.
- Assurez-vous que les paramètres figurant sur la plaque signalétique correspondent aux données électriques nominale de l'alimentation secteur.
- Utilisez toujours une prise de courant de sécurité correctement installée.

- N'utilisez pas d'adaptateurs multiprise et de rallonges.
- Veillez à ne pas endommager la fiche secteur ni le câble d'alimentation. Le remplacement du câble d'alimentation de l'appareil doit être effectué par notre service après-vente agréé.
- Ne laissez pas les câbles d'alimentation entrer en contact ou s'approcher de la porte de l'appareil ou de la niche d'encastrement sous l'appareil, particulièrement lorsqu'il est en marche ou que la porte est chaude.
- La protection contre les chocs des parties sous tension et isolées doit être fixée de telle manière qu'elle ne puisse pas être enlevée sans outils.
- Ne branchez la fiche secteur dans la prise secteur qu'à la fin de l'installation. Assurez-vous que la prise secteur est accessible après l'installation.
- Si la prise secteur est détachée, ne branchez pas la fiche secteur.
- Ne tirez pas sur le câble secteur pour débrancher l'appareil. Tirez toujours sur la fiche de la prise secteur.
- N'utilisez que des systèmes d'isolation appropriés : des coupe-circuits, des fusibles (les fusibles à visser doivent être retirés du support), un disjoncteur différentiel et des contacteurs.
- L'installation électrique doit comporter un dispositif d'isolation qui vous permet de déconnecter l'appareil du secteur à tous les pôles. Le dispositif d'isolement doit avoir une largeur d'ouverture de contact de 3 mm minimum.
- Cet appareil est fourni avec une fiche électrique et un câble d'alimentation.

2.3 Utilisation



AVERTISSEMENT!

Risque de blessures, de brûlures, d'électrocution ou d'explosion.

- Ne modifiez pas les spécifications de cet appareil.
- Assurez-vous que les orifices d'aération ne sont pas obstrués.
- Ne laissez pas l'appareil sans surveillance durant son fonctionnement.
- Éteignez l'appareil après chaque utilisation.
- Soyez prudent lors de l'ouverture de la porte de l'appareil lorsque celui-ci fonctionne. De l'air chaud peut se dégager.
- N'utilisez pas l'appareil avec des mains mouillées ou en contact avec de l'eau.
- N'exercez pas de pression sur la porte ouverte.
- N'utilisez pas l'appareil comme plan de travail ou comme espace de rangement.
- Ouvrez la porte de l'appareil avec précaution. L'utilisation d'ingrédients avec de l'alcool peut provoquer un mélange d'alcool et d'air.
- Ne laissez pas des étincelles ou des flammes nues entrer en contact avec l'appareil lorsque vous ouvrez la porte.
- Ne placez pas de produits inflammables ou d'éléments imbibés de produits inflammables à l'intérieur, à proximité ou au-dessus de l'appareil.
- N'utilisez pas la fonction micro-ondes pour préchauffer le four.



AVERTISSEMENT!

Risque d'endommagement de l'appareil.

- Pour éviter tout endommagement ou décoloration de l'émail :
 - ne placez jamais de feuilles d'aluminium directement sur le fond de la cavité de l'appareil.
 - ne versez pas d'eau directement dans l'appareil chaud.

CONSIGNES DE SÉCURITÉ

- ne conservez pas de plats et de nourriture humides dans l'appareil après avoir terminé la cuisson.
- Installez ou retirez les accessoires avec précautions.
- La décoloration de l'émail ou de l'acier inoxydable est sans effet sur les performances de l'appareil.
- Cuisinez toujours avec la porte de l'appareil fermée.
- Si l'appareil est installé derrière la paroi d'un meuble (par ex. une porte), veuillez à ce que la porte ne soit jamais fermée lorsque l'appareil fonctionne. La chaleur et l'humidité peuvent s'accumuler derrière la porte fermée du meuble et provoquer d'importants dégâts sur l'appareil, votre logement ou le sol. Ne fermez pas la paroi du meuble tant que l'appareil n'a pas refroidi complètement.

2.4 Entretien et Nettoyage



AVERTISSEMENT!

Risque de blessure, d'incendie ou de dommages matériels sur l'appareil.

- Avant toute opération d'entretien, éteignez l'appareil et débranchez la fiche de la prise secteur.
- Vérifiez que l'appareil est froid. Les panneaux de verre risquent de se briser.
- Remplacez immédiatement les vitres de la porte si elles sont endommagées. Contactez le service après-vente agréé.
- Soyez prudent lorsque vous retirez la porte de l'appareil. La porte est lourde !
- Veillez à sécher la cavité, le plateau tournant et la porte après chaque utilisation. La vapeur produite durant son fonctionnement se condense sur les parois de la cavité et peuvent entraîner une corrosion.
- Nettoyez régulièrement l'appareil afin de maintenir le revêtement en bon état.
- Les résidus de graisse et d'aliments dans l'appareil peuvent provoquer un incendie et un arc électrique lorsque la fonction micro-ondes est en cours.
- Nettoyez l'appareil avec un chiffon doux humide. Utilisez uniquement des produits de lavage neutres. N'utilisez pas de produits abrasifs, de tampons à récurer, de solvants ni d'objets métalliques.
- Si vous utilisez un spray pour four, suivez les consignes de sécurité figurant sur son emballage.

2.5 Éclairage interne



AVERTISSEMENT!

Risque d'électrocution !

- Concernant la/les lampe(s) à l'intérieur de ce produit et les lampes de rechange vendues séparément : Ces lampes sont conçues pour résister à des conditions physiques extrêmes dans les appareils électroménagers, telles que la température, les vibrations, l'humidité, ou sont conçues pour signaler des informations sur le statut opérationnel de l'appareil. Elles ne sont pas destinées à être utilisées dans d'autres applications et ne conviennent pas à l'éclairage des pièces d'un logement.
- Ce produit contient une source lumineuse de classe d'efficacité énergétique G.
- Utilisez uniquement des ampoules ayant les mêmes spécifications.

2.6 Service

- Pour réparer l'appareil, contactez le service après-vente agréé.

- Utilisez uniquement des pièces de rechange d'origine.

2.7 Mise au rebut



AVERTISSEMENT!

Risque de blessure ou d'asphyxie.

- Contactez votre service municipal pour obtenir des informations sur la marche à suivre pour mettre l'appareil au rebut.
- Débranchez l'appareil de l'alimentation électrique.
- Coupez le câble d'alimentation au ras de l'appareil et mettez-le au rebut.
- Retirez le dispositif de verrouillage du hublot pour empêcher les jeunes et les animaux de s'enfermer dans l'appareil.

3. DESCRIPTION DE L'APPAREIL

3.1 Vue d'ensemble

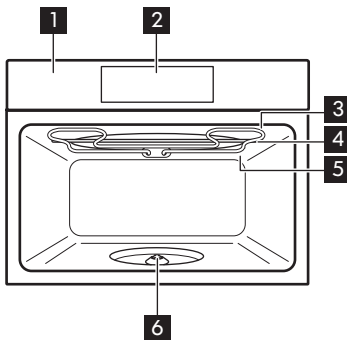

- 1** Bandeau de commande
- 2** Affichage
- 3** Résistance
- 4** Générateur de micro-ondes
- 5** Éclairage

- 6** Axe du plateau tournant

3.2 Accessoires

Ensemble Turntable

Pour préparer les aliments.

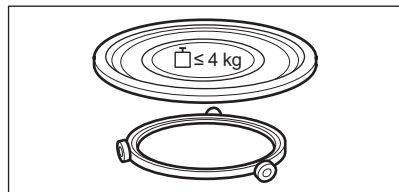

COMMENT ALLUMER ET ÉTEINDRE LE FOUR

Ensemble grill

Pour griller.

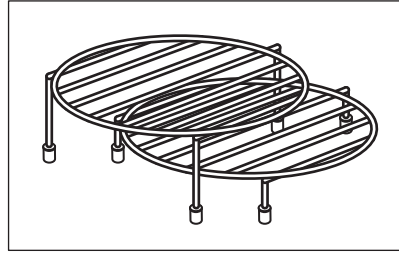

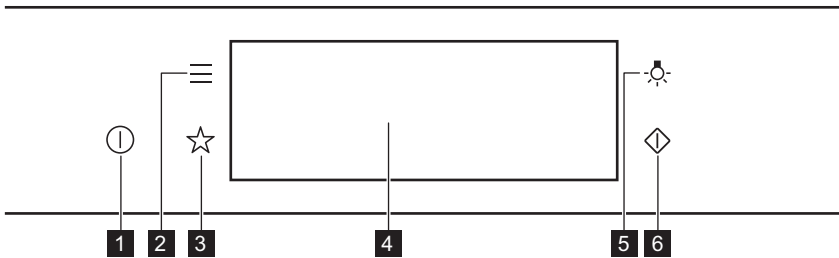

4. COMMENT ALLUMER ET ÉTEINDRE LE FOUR

4.1 Bandeau de commande





1	Activez / Désactivez	Appuyez et maintenez enfoncé pour allumer et éteindre le four.
2	Menu	Indique les fonctions du four.
3	Mes programmes	Indique les réglages favoris.
4	Affichage	Affiche les réglages actuels du four.
5	Curseur de l'éclairage	Pour allumer et éteindre l'éclairage.
6	Départ rapide micro-ondes	Pour activer la fonction micro-ondes (1 000 W et 30 secondes).

COMMENT ALLUMER ET ÉTEINDRE LE FOUR

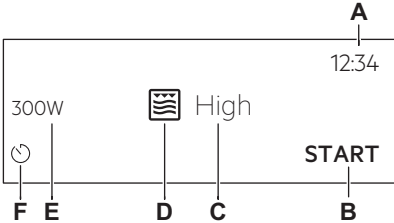
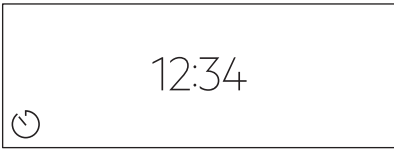

 <p>Appuyez sur la touche</p>	 <p>Déplacez</p>	 <p>Maintenez la touche</p>
<p>Appuyez sur la surface du bout du doigt.</p>	<p>Faites glisser le bout de votre doigt sur la surface.</p>	<p>Appuyez sur la surface pendant 3 secondes.</p>

4.2 Affichage

 <p>The diagram shows a control panel with the following elements labeled A through F:</p> <ul style="list-style-type: none"> A: Points to the time display '12:34'. B: Points to the 'START' button. C: Points to the 'High' power level indicator. D: Points to the grill icon. E: Points to the '300W' power level indicator. F: Points to the clock icon. 	<p>Après avoir allumé l'appareil, l'écran principal s'affiche avec la fonction et l'intensité du grill par défaut.</p> <ul style="list-style-type: none"> A. Heure actuelle B. DEMARRER/ARRETER C. Intensité du grill D. Modes de cuisson E. Puissance du micro-ondes F. Minuteur
 <p>The screenshot shows a digital display with the time '12:34' and a small clock icon in the bottom left corner.</p>	<p>Si vous n'utilisez pas le four dans les 2 minutes qui suivent, l'affichage se met en veille.</p>
 <p>The screenshot shows the display during cooking with the following information:</p> <ul style="list-style-type: none"> Power: 1000W Grill icon and 'High' level Time: 1m23s Remaining time: +30s 'STOP' indicator at the bottom 	<p>Lorsque vous cuisinez, l'affichage indique les fonctions définies et d'autres options disponibles.</p>



Voyants de l'affichage

Indicateurs de base - pour naviguer dans l'affichage.



<p>OK</p> <p>Pour confirmer la sélection/le réglage.</p>	<p></p> <p>Pour remonter d'un niveau dans le menu.</p>	<p></p> <p>Pour annuler la dernière action.</p>	<p></p> <p>Pour activer et désactiver les options.</p>
---	---	--	---

AVANT LA PREMIÈRE UTILISATION

Son alarme indicateurs de fonction - lorsque la durée de cuisson programmée est écoulée, le signal sonore retentit.

 La fonction est activée.	 La fonction est activée. La cuisson s'arrête automatiquement.	 Le son alarme est désactivé.
---	---	---

Voyants du minuteur

 Pour régler la fonction : Démarrage retardé.	 Pour annuler le réglage.
---	---



5. AVANT LA PREMIÈRE UTILISATION



AVERTISSEMENT!

Reportez-vous aux chapitres concernant la sécurité.

5.1 Nettoyage initial

		
Étape 1	Étape 2	Étape 3
Retirez tous les accessoires du four.	Nettoyez le four et les accessoires avec un chiffon doux, de l'eau tiède et un détergent doux.	Placez les accessoires dans le four.

5.2 Première connexion

L'affichage indique un message de bienvenue après la première connexion.

Vous devez régler : Langue, Affichage Luminosité, Son touches, Volume alarme, Heure actuelle.

6. UTILISATION QUOTIDIENNE



AVERTISSEMENT!

Reportez-vous aux chapitres concernant la sécurité.

6.1 Comment régler la fonction : Gril + Micro-ondes, Gril

Le four peut émettre des bruits lors de l'utilisation de la fonction : Gril + Micro-ondes. Ceci est normal avec cette fonction.

Réglage de la fonction : Gril + Micro-ondes	
Étape 1	Insérez la grille basse.
Étape 2	Allumez le four. Le mode de cuisson par défaut s'affiche.
Étape 3	Appuyez sur le symbole du mode de cuisson pour accéder au sous-menu.
Étape 4	Sélectionnez la fonction :  . Appuyez sur : OK.
Étape 5	Sélectionnez le niveau d'intensité du gril.
Fonction	Niveau d'intensité du gril
Lo	Faible
Hi	Élevé
Étape 6	Appuyez sur OK.
Étape 7	Appuyez sur START .
STOP - appuyez pour éteindre le four.	
Étape 8	Éteignez le four.

La puissance des micro-ondes est limitée à 500 W lorsque vous utilisez la fonction : Gril + Micro-ondes.

Réglage de la fonction : Gril	
Étape 1	Insérez la grille supérieure.
Étape 2	Allumez le four. Le mode de cuisson par défaut s'affiche.
Étape 3	Appuyez sur le symbole du mode de cuisson pour accéder au sous-menu.
Étape 4	Sélectionnez la fonction :  . Appuyez sur : OK.
Étape 5	Sélectionnez le niveau d'intensité du gril.

Réglage de la fonction : Gril	
Fonction	Niveau d'intensité du gril
Lo	Faible
Hi	Élevé
Étape 6	Appuyez sur OK.
Étape 7	Appuyez sur START .
STOP - appuyez sur pour désactiver la fonction.	
Étape 8	Éteignez le four.

6.2 Comment régler : Modes de cuisson micro-ondes

Étape 1	Allumez le four.
Étape 2	Appuyez sur le symbole du mode de cuisson pour accéder au sous-menu.
Étape 3	Sélectionnez le mode de cuisson micro-ondes et appuyez sur : OK. L'affichage indique : puissance micro-ondes.
Étape 4	Réglage : puissance micro-ondes. Appuyez sur OK.
Étape 5	Appuyez sur START .
STOP - appuyez sur pour désactiver la fonction.	
Étape 6	Éteignez le four.

La durée maximale des fonctions Micro-ondes dépend de la puissance sélectionnée :

PUISSANCE DU MICRO-ONDES	DURÉE MAXIMALE
100 – 600 W	59 minutes

PUISSANCE DU MICRO-ONDES	DURÉE MAXIMALE
Plus de 600 W	7 minutes

 Si vous ouvrez la porte, la fonction s'arrête. Pour la redémarrer, appuyez sur START .

Prenez un raccourci !





6.3 Comment utiliser : Départ rapide micro-ondes

Étape 1	Maintenez la touche  . La fonction micro-ondes est active pendant 30 s.	
Étape 2	Pour prolonger le temps de cuisson :	
	Appuyez sur la valeur de durée de fonctionnement pour accéder aux réglages de la durée. Réglez le temps de cuisson.	Appuyez sur +30 s .
La fonction micro-ondes peut être activée à tout moment avec : Départ rapide micro-ondes.		

6.4 Modes de cuisson





FONCTIONS STANDARD

Mode de cuisson	Application
 Gril	Pour faire griller des aliments peu épais et du pain.
 Gril + Micro-ondes	Pour cuire des aliments rapidement et pour les faire gratiner. Vous pouvez régler 2 niveaux d'intensité du gril : bas et élevé.

FONCTIONS DE L'HORLOGE

Mode de cuisson	Application
 Micro-ondes	Chauffage, cuisson, plage de puissance : 100 à 1 000 W

MICRO-ONDES

Mode de cuisson	Application
 Décongélation	Décongélation de viande, poisson, gâteaux, plage de puissance : 100 à 200 W
 Fondre	Fondre du chocolat et du beurre, plage de puissance : 100 à 400 W
 Réchauffer	Chauffage de plats préparés et d'aliments délicats, plage de puissance : 300 à 700 W
 Popcorn	Préparation de pop-corn, plage de puissance : 700 à 1 000 W
 Liquides	Chauffage de boissons et de soupes, plage de puissance : 800 à 1 000 W

7. FONCTIONS DE L'HORLOGE

7.1 Description des fonctions de l'horloge

Fonctions de l'horloge	Application
Heure de cuisson	Pour définir la durée de la cuisson. Le maximum est de 23 h 59 min.
Fin de l'action	Pour programmer l'action à la fin du décompte du minuteur.
Prolongation de la durée	Pour prolonger le temps de cuisson.

Fonctions de l'horloge	Application
Rappel	Pour régler un décompte. Le maximum est de 23 h 59 min. Cette fonction n'a aucun effet sur le fonctionnement du four.
Compteur	Surveille la durée de fonctionnement de la fonction. Compteur - vous pouvez l'activer et la désactiver.

7.2 Comment régler : Fonctions de l'horloge

Comment régler l'horloge	
Étape 1	Appuyez sur : Heure actuelle.
Étape 2	Réglez l'heure. Appuyez sur : OK.

Comment régler le temps de cuisson	
Étape 1	Choisissez le mode de cuisson.
Étape 2	Appuyez sur  .
Étape 3	Réglez l'heure. Appuyez sur : OK.

Comment choisir une option de fin	
Étape 1	Choisissez le mode de cuisson.
Étape 2	Appuyez sur  .
Étape 3	Réglez le temps de cuisson.
Étape 4	Appuyez sur : ● ● ● .
Étape 5	Appuyez sur Fin de l'action.
Étape 6	Choisissez la valeur souhaitée : Fin de l'action.
Étape 7	Appuyez sur : OK. Répétez l'action jusqu'à ce que l'écran principal soit affiché.

CONSEILS D'UTILISATION : ACCESSOIRES

Comment prolonger le temps de cuisson

S'il ne reste que 10 % du temps de cuisson et que les aliments ne semblent toujours pas cuits, vous pouvez prolonger le temps de cuisson. Vous pouvez également modifier le mode de cuisson.

Appuyez sur **+1min** pour prolonger le temps de cuisson.

Comment modifier les réglages du minuteur

Étape 1 Appuyez sur : .

Étape 2 Réglez la valeur du minuteur.

Étape 3 Appuyez sur : .

Vous pouvez modifier la durée à tout moment en cours de cuisson.

8. CONSEILS D'UTILISATION : ACCESSOIRES

8.1 Insertion des accessoires

Utilisez uniquement des récipients et des matériaux adaptés. Reportez-vous au paragraphe « Ustensiles et matériaux adaptés aux micro-ondes » dans le chapitre « Conseils ».

Ensemble Turntable:

Faites toujours cuire les aliments sur le plateau tournant.
Placez le guide à roulettes autour de l'axe du plateau tournant. Placez la partie en verre du plateau tournant sur le support à roulettes.
N'utilisez que l'ensemble du plateau tournant fourni avec le four.

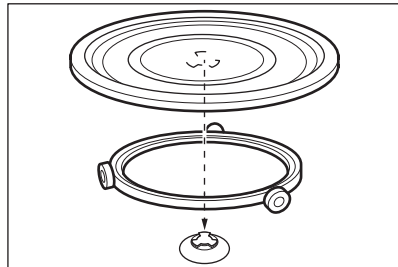

Ensemble grill:

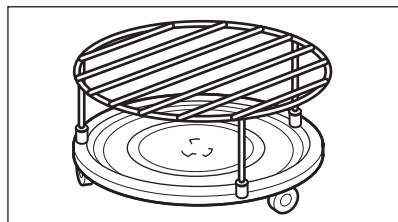

Placez la grille avec les capuchons en silicone sur le plateau tournant.



9. FONCTIONS SUPPLÉMENTAIRES



9.1 Comment sauvegarder : Mes programmes

Vous pouvez sauvegarder vos réglages favoris, tels que le mode de cuisson, le temps de cuisson ou la fonction de nettoyage. Vous pouvez sauvegarder 3 réglages favoris.

Étape 1	Mettez en fonctionnement le four.
Étape 2	Sélectionnez le réglage préféré.
Étape 3	Appuyez sur :  . Sélectionnez : Mes programmes.
Étape 4	Sélectionnez : Enregistrer les réglages actuels.
Étape 5	Appuyez sur + pour ajouter le réglage à la liste de : Mes programmes. Appuyez sur la touche OK.
<p> - appuyez pour réinitialiser le réglage.</p> <p> - appuyez pour annuler le réglage.</p>	

9.2 Verrouillage des touches

Cette fonction permet d'éviter une modification involontaire du mode de cuisson.

Étape 1	Allumez le four.
Étape 2	Sélectionnez un mode de cuisson.
Étape 3	 ,  - appuyez simultanément pour activer la fonction.
Pour désactiver la fonction, répétez l'étape 3.	

9.3 Ventilateur de refroidissement

Lorsque le four fonctionne, le ventilateur de refroidissement se met automatiquement en marche pour refroidir les surfaces du four. Si vous éteignez le four, le ventilateur de refroidissement continue à fonctionner jusqu'à ce que le four refroidisse.

10. CONSEILS

10.1 Recommandations de cuisson



Les températures et temps de cuisson se trouvant dans les tableaux ne sont indiqués qu'à titre indicatif. Ils varient selon les recettes, la qualité et la quantité des ingrédients utilisés.

Votre four peut cuire d'une manière complètement différente de celle de votre ancien four. Les conseils ci-dessous présentent les modes de cuisson et les réglages des temps de cuisson pour des types d'aliments spécifiques.

Si vous ne trouvez pas les réglages appropriés pour une recette spécifique, cherchez-en une qui s'en rapproche.

Pour plus de recommandations de cuisson, consultez les tableaux de cuisson sur notre site Internet. Pour trouver les conseils de cuisson, vérifiez le code produit (PNC) sur la plaque signalétique qui se trouve sur le cadre avant de la cavité du four.

10.2 Recommandations pour le micro-ondes

Cuisinons !

Ne placez pas les aliments directement sur le plateau tournant. Utilisez toujours un récipient adapté aux micro-ondes.

Placez le récipient au milieu du plateau tournant.

Tout contact avec des produits trop chauds ou trop froids peut casser le plateau tournant.

Retournez ou remuez les aliments à la moitié du temps de décongélation et de cuisson.

De temps en temps, mélangez les plats liquides en cours de cuisson.

Mélangez les aliments avant de les servir.

Couvrez les aliments pour la cuisson et le réchauffage.

Introduisez une cuillère dans la bouteille ou le verre lorsque vous réchauffez des liquides, pour garantir une meilleure distribution de la chaleur.

Placez les aliments dans le four sans emballage. Les plats préparés emballés peuvent être placés dans le four uniquement si l'emballage est adapté à la cuisson au four à micro-ondes (vérifiez les informations sur l'emballage).



Cuisson au micro-ondes

Couvrez les aliments pour les faire cuire. Si vous souhaitez que les aliments restent croustillants, faites-les cuire sans les couvrir.

Ne cuisez pas trop les plats en réglant une puissance ou une durée trop élevées. Les aliments peuvent se dessécher, brûler ou prendre feu.

N'utilisez pas le four pour cuire des œufs ou des escargots dans leur coquille car ils peuvent exploser. Percez le jaune des œufs au plat avant de les réchauffer.

Percez plusieurs fois les aliments comportant une peau ou pelez-les avant de les faire cuire.

Coupez les légumes en morceaux de même taille.

Après avoir mis à l'arrêt le four, sortez le plat et laissez-le reposer pendant quelques minutes pour que la chaleur se répartisse uniformément.



Décongélation au micro-ondes

Placez les aliments surgelés déballés sur une petite assiette retournée avec un récipient en-dessous, ou sur une grille de décongélation ou une passoire en plastique afin que l'eau de décongélation puisse s'évacuer.





Retirez ensuite les morceaux décongelés.

Vous pouvez utiliser une puissance de micro-ondes plus élevée pour cuire les fruits et légumes sans les décongeler.





10.3 Ustensiles de cuisine et matériaux adaptés aux micro-ondes

Pour la cuisson au micro-ondes, n'utilisez que des récipients et matériaux adaptés. Utilisez le tableau ci-dessous comme référence.

Vérifiez les caractéristiques des ustensiles de cuisine / des matériaux avant utilisation.



Ustensiles de cuisine / Matériaux				
Verre et porcelaine allant au four ne contenant aucun composant métallique, par ex. le verre résistant à la chaleur	✓	✓	✓	✓
Verre et porcelaine n'allant pas au four sans décor en argent, or, platine ou métal	✓	X	X	X
Verre et vitrocéramique en matériau résistant aux températures élevées/basses	✓	✓	✓	✓
Récipients en céramique et en faïence sans composant en quartz ou en métal, ni verni contenant du métal	✓	✓	X	X
Céramique, porcelaine et faïence dont le fond n'est pas verni ou avec de petits trous, par exemple sur les poignées	X	X	X	X
Plastique résistant à la chaleur jusqu'à 200 °C	✓	✓	X	X
Carton, papier	✓	X	X	X
Film étirable	✓	X	X	X







CONSEILS



Ustensiles de cuisine / Matériaux				
Sachet de cuisson avec fermeture de sûreté pour micro-ondes	✓	✓	X	X
Plats à rôtir en métal, par ex. en émail, en fonte	X	X	✓	X
Moules à gâteaux, laqués noirs ou avec revêtement en silicone	X	X	✓	X
Ustensiles pour une utilisation au micro-ondes, par ex. plat pour cuisson croustillante	X	✓	X	X
Ensemble grill	X	X	✓	✓





10.4 Réglages recommandés pour différents types d'aliments

Les données du tableau sont fournies à titre indicatif uniquement.

800 à 1 000 W	
 Saisir au début du processus de cuisson	 Chauffer des liquides

500 à 700 W					
 Cuisson des légumes	 Faire cuire des plats à base d'œufs	 Faire mijoter des ragoûts	 Faire mijoter du riz	 Réchauffer des plats pour une assiette	 Décongeler et chauffer des plats surgelés





300 à 400 W		
 Faire fondre du fromage, du chocolat, du beurre	 Cuire / Réchauffer des aliments délicats	 Poursuivre la cuisson

100 à 200 W				
 Réchauffer des aliments pour bébés	 Décongeler du pain	 Décongeler des fruits et des gâteaux	 Décongeler du fromage, de la crème, du beurre	 Décongeler de la viande, du poisson

10.5 Tableaux de cuisson pour les instituts de tests





Informations pour les organismes de contrôle

Tests conformément à la norme IEC 60705.

FONCTION MICRO-ONDES	 (W)	 (kg)		 (min)	
Génoise	600	0.475	Ensemble du plateau tournant	5 - 7	-
Rôti haché	500	0.9	Ensemble Turntable	18 - 20	-
Crème anglaise aux œufs	500	1	Ensemble du plateau tournant	15 - 17	-
Décongélation de viande	200	0.5	Ensemble du plateau tournant	8 - 9	-

ENTRETIEN ET NETTOYAGE

Utilisez la fonction : Gril au micro-ondes.
Utilisez la grille basse.

FONCTION COMBI MI-CRO-ONDES	 POWER (W)	 Niveau d'intensité du gril	 (min)	
Gratin de pommes de terre, 1,1 kg	300	faible	30 - 35	-
Poulet, 1,1 kg	300	élevé	30 - 35	Mettez la viande dans un récipient rond en verre.

11. ENTRETIEN ET NETTOYAGE



AVERTISSEMENT!

Reportez-vous aux chapitres concernant la sécurité.

11.1 Remarques concernant l'entretien



Agents nettoyants

Nettoyez la façade du four avec un chiffon doux, de l'eau tiède et un détergent doux.

Utilisez une solution de nettoyage pour nettoyer les surfaces métalliques.

Nettoyez les taches avec un détergent doux.



Utilisation quotidienne

Nettoyez la cavité après chaque utilisation. L'accumulation de graisse ou d'autres résidus peut provoquer un incendie. Nettoyez soigneusement la voûte du four pour éliminer les résidus et la graisse.

Ne conservez pas les aliments dans le four pendant plus de 20 minutes. Sécher la cavité avec un chiffon doux après chaque utilisation.

	<p>Après chaque utilisation, lavez tous les accessoires et séchez-les. Avant le nettoyage, attendez que le plateau tournant soit froid. Le plateau tournant risque de se briser. Utilisez un chiffon doux avec de l'eau tiède et un détergent doux. Ne lavez pas les accessoires au lave-vaisselle.</p>
<p>Accessoires</p>	<p>Ne nettoyez pas les accessoires antiadhésifs avec un produit nettoyant abrasif ou des objets tranchants.</p>



12. DÉPANNAGE





AVERTISSEMENT!

Reportez-vous aux chapitres concernant la sécurité.



12.1 Que faire si...

 Le four ne s'allume pas ou ne chauffe pas	
 Cause probable	 Solution
<p>Le four n'est pas branché à une source d'alimentation électrique ou le branchement est incorrect.</p>	<p>Vérifiez que le four est correctement branché à une source d'alimentation électrique.</p>
<p>L'horloge n'est pas réglée.</p>	<p>Réglez l'horloge, consultez le chapitre « Fonctions de l'horloge » pour avoir tous les détails, Comment régler : Fonctions de l'horloge.</p>
<p>La porte n'est pas correctement fermée.</p>	<p>Fermez complètement la porte.</p>
<p>Le fusible a disjoncté.</p>	<p>Vérifiez que le fusible est bien la cause de l'anomalie. Si le problème se reproduit, faites appel à un électricien qualifié.</p>
<p>La Sécurité enfants du four est activée.</p>	<p>Consultez le chapitre « Menu », Sous-menu : Options.</p>

 Composants	
 Description	 Solution
L'ampoule est grillée.	Remplacez l'ampoule, pour avoir des détails consultez le chapitre « Entretien et nettoyage », Comment remplacer : Éclairage.
L'ensemble du plateau tournant fait du bruit.	Des résidus d'aliments sont présents sous l'ensemble du plateau tournant.

12.2 Comment gérer : Codes d'erreur

Quand une erreur de logiciel se produit, l'affichage indique un message d'erreur. Cette section présente la liste des problèmes que vous pouvez gérer seul.

 Code et description	 Solution
F240, F439 - les champs tactiles de l'affichage ne fonctionnent pas correctement.	Nettoyez la surface de l'affichage. Vérifiez que les champs tactiles sont propres.
F908 - le système du four ne peut pas se connecter au panneau de commande.	Éteignez le four et rallumez-le .

12.3 Données de maintenance

Si vous ne trouvez pas de solution au problème, veuillez contacter votre revendeur ou un service après-vente agréé.

Les informations nécessaires au service après-vente figurent sur la plaque signalétique. La plaque signalétique se trouve sur le cadre avant de la cavité du four. Ne retirez pas la plaque signalétique de la cavité du four.

Nous vous recommandons d'écrire les informations ici :	
Modèle (Mod.)
Référence produit (PNC)
Numéro de série (S.N.)

13. RENDEMENT ÉNERGÉTIQUE

13.1 Économie d'énergie



Ce four est doté de caractéristiques qui vous permettent d'économiser de l'énergie lors de votre cuisine au quotidien.

Lorsque le four est en marche, assurez-vous que la porte est bien fermée. Évitez d'ouvrir la porte trop souvent pendant la cuisson. Nettoyez régulièrement le joint de porte et assurez-vous qu'il est bien en place.

Dans la mesure du possible, ne préchauffez pas le four avant la cuisson.

Lorsque vous préparez plusieurs plats à la fois, faites en sorte que les pauses entre les cuissons soient aussi courtes que possible.

Cuisson avec l'éclairage éteint

Éteignez l'éclairage en cours de cuisson. Ne l'allumez que lorsque vous en avez besoin.

14. STRUCTURE DES MENUS

14.1 Menu

Appuyez sur pour ouvrir Menu .

Élément du menu		Application
Mes programmes		Indique les réglages favoris.
Options		Pour régler la configuration du four.
Configurations	Configuration	Pour régler la configuration du four.
	Service	Affiche la version et la configuration du logiciel.

14.2 Sous-menu pour : Options

Sous-menu	Application
Eclairage four	Allume et éteint l'éclairage.
Sécurité enfants	Empêche l'activation accidentelle du four. Lorsque l'option est activée, le texte « Sécurité enfants » s'affiche lorsque vous allumez le four. Pour permettre l'utilisation du four, choisissez les lettres du code dans l'ordre alphabétique. L'accès au minuteur, à la télécommande et à l'éclairage est possible avec la Sécurité enfants activée.

C'EST SIMPLE !

Sous-menu	Application
Indication Du Temps	Allume et éteint l'horloge.
Affichage Heure	Change le format de l'affichage de l'heure.

14.3 Sous-menu pour : Configuration

Sous-menu	Description
Langue	Définit la langue du four.
Affichage Luminosité	Règle la luminosité de l'affichage.
Son touches	Active et désactive la tonalité des champs tactiles. Il n'est pas possible de couper la tonalité pour : ①.
Volume alarme	Règle le volume des signaux sonores et des tonalités des touches.
Heure actuelle	Règle l'heure et la date actuelles.

14.4 Sous-menu pour : Service

Sous-menu	Description
Mode démo	Code d'activation / de désactivation : 2468
Version du logiciel	Informations sur la version logicielle.
Réinitialiser tous les réglages	Restaure les réglages d'usine.

15. C'EST SIMPLE !









Avant la première utilisation, vous devez régler :				
Langue	Affichage Luminosité	Son touches	Volume alarme	Heure actuelle

Familiarisez-vous avec les symboles de base du bandeau de commande et de l'affichage :

 Activez / Désactivez	 Menu	 Mes programmes	 Minuteur	START / STOP
---	---	---	---	--------------

Pour commencer à utiliser le four

Démarrage rapide Micro-ondes	Pour démarrer le micro-ondes à tout moment avec les réglages par défaut 30 sec / 1 000 W	Appuyez sur : 
-------------------------------------	--	---



			
chauffer / cuire 100 à 1 000 W	cuire / gratiner intensité : basse / élevée	cuire / gratiner	chauffer des liquides 800 à 1 000 W
			
réchauffer 300 à 700 W	décongeler 100 à 200 W	faire fondre 100 à 400 W	préparer du popcorn 700 à 1 000 W

Réglages du micro-ondes		Conseils pour micro-ondes
Puissance du micro-ondes :	Durée maximale :	Couvrez les aliments pour la cuisson et le réchauffage. Retournez ou remuez les aliments à la moitié du temps de décongélation et de cuisson. Mettez la cuillère dans le plat lorsque vous faites chauffer des liquides. Placez les aliments dans le four sans emballage (uniquement compatible micro-ondes).
100 – 600 W	59 min	
> 600 W	7 min	

Pour lancer la cuisson

Étape 1	Étape 2	Étape 3	Étape 4	Étape 5
----------------	----------------	----------------	----------------	----------------

Pour lancer la cuisson

 - appuyez pour allumer le four.	 ... - sélectionnez la fonction.	W - réglez la puissance du micro-ondes.	OK - appuyez pour confirmer.	START - appuyez pour démarrer la cuisson.
--	--	---	--	---



Utiliser les fonctions rapides pour régler le temps de cuisson

Assist. Fin 10 %

Utilisez la fonction Assist. Fin 10 % pour prolonger la cuisson lorsqu'il ne reste que 10 % du temps de cuisson.

Pour prolonger le temps de cuisson, appuyez sur **+1 min.**

16. EN MATIÈRE DE PROTECTION DE L'ENVIRONNEMENT

Recyclez les matériaux portant le symbole . Déposez les emballages dans les conteneurs prévus à cet effet. Contribuez à la protection de l'environnement et à votre sécurité, recyclez vos produits électriques et électroniques. Ne jetez pas les appareils portant le symbole  avec les ordures ménagères. Emmenez un tel produit dans votre centre local de recyclage ou contactez vos services municipaux.

FR Concerne la France uniquement :



Points de collecte sur www.quefairedemesdechets.fr
Privilégiez la réparation ou le don de votre appareil !

A TÖKÉLETES VÉGEREDMÉNY ÉRDEKÉBEN

Köszönjük, hogy ezt az AEG készüléket választotta. Termékünk gyártásakor egy olyan berendezést kívántunk megalkotni az Ön számára, amely kifogástalan teljesítményt nyújt hosszú éveken keresztül, köszönhetően az alkalmazott innovatív technológiáknak, amelyek az életét jelentősen megkönnyítik – és amelyeket más készülékeken nem talál meg. Kérjük, szánjon néhány percet az útmutató végigolvasására, hogy a maximumot hozhassa ki készülékéből.

Látogasson el weboldalunkra az alábbiakért:



Használattal kapcsolatos tanácsok, prospektusok, hibaelhárítási, szerviz- és javítási információk kérése:

www.aeg.com/support



Regisztrálja termékét a még kiválóbb szolgáltatásokért:

www.registeraeg.com



Tartozékok, segédanyagok és eredeti alkatrészek vásárlása a készülékhez:

www.aeg.com/shop

ÜGYFÉLSZOLGÁLAT ÉS SZERVIZ

Mindig eredeti cserealkatrészeket használjon.

Amikor felveszi a kapcsolatot a hivatalos szervizközponttal, gondoskodjon arról, hogy a következő adatok kéznél legyenek: Típus, PNC (termékszám), sorozatszám.

Az információk az adattáblán találhatóak.

 **Figyelem / Vigyázat – Biztonsági információk**

 **Általános információk és tanácsok**

 **Környezetvédelmi információk**

A változtatások jogát fenntartjuk.

TARTALOM

1. BIZTONSÁGI INFORMÁCIÓK.....	182	3. TERMÉKLEÍRÁS.....	189
1.1 Gyermekek és fogyatékkal élő személyek biztonsága.....	182	3.1 Általános áttekintés.....	189
1.2 Általános biztonság.....	183	3.2 Tartozékok.....	189
2. BIZTONSÁGI UTASÍTÁSOK.....	185	4. A SÜTŐ BE- ÉS KIKAPCSOLÁSA.....	189
2.1 Üzembe helyezés.....	185	4.1 Kezelőpanel.....	189
2.2 Elektromos csatlakozás.....	186	4.2 Kijelző.....	190
2.3 Használat.....	187	5. AZ ELSŐ HASZNÁLAT ELŐTT.....	191
2.4 Ápolás és tisztítás.....	188	5.1 Kezdeti tisztítás	192
2.5 Belső világítás.....	188	5.2 Első csatlakoztatás.....	192
2.6 Szolgáltatások.....	188		
2.7 Ártalmatlanítás.....	188		

6. NAPI HASZNÁLAT.....	192	10.4 Különböző ételekhez javasolt teljesítmény-beállítások.....	201
6.1 A következő funkció beállítása: Grill + mikro, Grill.....	192	10.5 Ételkészítési táblázatok a bevizsgáló intézetek számára.....	202
6.2 Mikrohullámú sütőfunkciók beállítása.....	194	11. ÁPOLÁS ÉS TISZTÍTÁS.....	203
6.3 Használata: Mikrohullám gyorsindítás.....	194	11.1 Tisztítással kapcsolatos megjegyzések.....	203
6.4 Sütőfunkciók.....	195	12. HIBAE LHÁRÍTÁS.....	204
7. ÓRAFUNKCIÓK.....	196	12.1 Mi a teendő, ha.....	204
7.1 Órafunkciók leírása.....	196	12.2 Hogyan kezelje: Hibakódok.....	205
7.2 Órafunkciók beállítása.....	196	12.3 A szerviz számára szükséges adatok.....	205
8. HOGYAN HASZNÁLJA: TARTOZÉKOK	198	13. ENERGIAHATÉKONYSÁG.....	206
8.1 Tartozékok behelyezése.....	198	13.1 Energiatakarékoság.....	206
9. TOVÁBBI FUNKCIÓK.....	198	14. A MENÜ FELÉPÍTÉSE.....	206
9.1 Hogyan mentheti: Kedvencek.....	198	14.1 Menü.....	206
9.2 Funkciózár.....	199	14.2 Almenü ehhez: Egyéb funkciók.....	206
9.3 Hűtőventilátor.....	199	14.3 Almenü ehhez: Beállítás.....	207
10. HASZNOS TANÁCSOK ÉS JAVASLATOK.....	199	14.4 Almenü a következőhöz: Szervíz.....	207
10.1 Sütési javaslatok.....	199	15. EGYSZERŰ!.....	207
10.2 Javaslatok a mikrohullámú sütőhöz.....	199	16. KÖRNYEZETVÉDELMI TUDNIVALÓK.....	209
10.3 Mikrohullámú sütőben használható főzőedények és anyagok.....	200		

1. BIZTONSÁGI INFORMÁCIÓK

Az üzembe helyezés és használat előtt gondosan olvassa el a mellékelt útmutatót. A gyártó nem vállal felelősséget a helytelen beszerelés vagy használat miatt keletkezett sérülésekért és károkért. Tartsa biztonságos és elérhető helyen az útmutatót, hogy szükség esetén mindig a rendelkezésére álljon.

1.1 Gyermek és fogyatékkal élő személyek biztonsága

- Ezt a készüléket 8 év feletti gyermekek, csökkent fizikai, érzékelési vagy szellemi képességekkel rendelkező felnőttek, illetve megfelelő tudással vagy gyakorlattal nem rendelkező személyek csak felügyelet mellett, vagy abban

az esetben használhatják, ha megfelelő oktatást kaptak a készülék biztonságos használatára, és megértik az esetleges veszélyeket. A 8 évesnél fiatalabb gyermekek, illetve a súlyos, komplex fogyatékkal élő személyek állandó felügyelet nélkül nem tartózkodhatnak a készülék közelében.

- Gondoskodni kell a gyermekek felügyeletéről, hogy ne játsszanak a készülékkel.
- Minden csomagolóanyagot tartson távol a gyermekektől, és megfelelően ártalmatlanítsa.
- FIGYELEM: A gyermekeket és kedvenc háziállatokat tartsa távol a készüléktől működés közben, és működés után, lehűléskor. Használat közben a készülék hozzáférhető részei felforrósodnak.
- Ha rendelkezik gyermekbiztonsági zárral a készülék, akkor azt be kell kapcsolni.
- Gyermekek felügyelet nélkül nem végezhetnek tisztítási vagy karbantartási tevékenységet a készüléken.

1.2 Általános biztonság

- A készülék kizárólag ételkészítési célra szolgál.
- Ezt a készüléket háztartási célú, beltérben történő használatra tervezték.
- Ez a készülék használható irodákban, szállodai vendégszobákban, panziókban, vendégházakban és más hasonló szálláshelyeken, ahol a használat nem haladja meg a háztartási használat (átlagos) szintjét.
- A készülék üzembe helyezését és a hálózati kábel cseréjét csak képezített személy végezheti el.
- A bútorba való beépítés előtt ne használja a készüléket.
- Bármilyen karbantartás megkezdése előtt válassza le a készüléket az elektromos hálózatról.
- Ha a hálózati kábel megsérül, azt a gyártónak vagy a márkaszerviznek vagy más hasonlóan képzett személynek kell kicserélnie, nehogy elektromos veszélyhelyzet álljon elő.

- **FIGYELEM:** Az izzó cseréje előtt győződjön meg arról, hogy a készülék ki van kapcsolva, hogy megelőzze áramütést.
- **FIGYELEM:** Használat közben a készülék és hozzáférhető részei nagyon felforrósodhatnak. Legyen óvatos, hogy ne érjen a fűtőelemekhez.
- Amikor a sütőből kiveszi vagy behelyezi a tartozékokat vagy edényeket, mindig használjon konyhai edényfogó kesztyűt.
- Csak a készülékhez tervezett forgótányért és forgótányér tartót használja.
- Ne indítsa el a mikrohullám funkciót, amikor a készülék üres. A sütőtérben levő fém alkatrészek szikraképződést okozhatnak.
- Fémből készült étel- és italtároló edények nem használhatók mikrohullámú főzés közben. Ez a szabály nem érvényes akkor, ha a gyártó megadja azon fém tárolóedények méretét és alakját, melyek alkalmasak mikrohullámú főzéshez.
- **FIGYELEM:** A sütőajtó vagy az ajtó tömítések sérülése esetén ne használja a készüléket mindaddig, amíg azt egy szakképzett személy meg nem javította.
- **FIGYELEM:** Kizárólag szakember végezhet bármely olyan javítást, mely a mikrohullámú energia ellen védelmet nyújtó burkolat eltávolításával jár.
- **FIGYELEM:** Ne melegítsen folyadékot vagy egyéb élelmiszert lezárt edényben. Ezek ilyenkor felrobbanhatnak.
- Csak olyan edényeket használjon, amelyek mikrohullámú sütőben való használatra alkalmasak.
- Ha műanyag-, illetve papírdobozban melegít ételt, a meggyulladás elkerülése érdekében tartsa szemmel a készüléket.
- A készüléket élelmiszerek és italok melegítésére tervezték. Az élelmiszerek vagy ruhaneműk szárítása, valamint a melegítőpárnák, papucsok, szivacsok, nedves konyharuhák és hasonló melegítése sérüléshez, felgyulladásához vagy tűzhez vezethet.

- Ha a készülék füstöt bocsát ki, kapcsolja ki, vagy húzza ki a dugót a konnektorból, és tartsa az ajtót zárva, hogy elfojtsa az esetleges lángokat.
- Az italok mikrohullámmal történő melegítése késleltetett robbanásszerű forrást eredményezhet. Ezért óvatosan járjon el az edény kezelésekor.
- A cumis üvegek, valamint a bébiételes üvegek tartalmát fogyasztás előtt fel kell rázni, és az égési sérülések elkerülése érdekében ellenőrizni kell azok hőmérsékletét.
- A friss vagy főtt egész tojás a héjában nem melegíthető a mikrohullámú sütővel, mivel az, akár a melegítést követően is, felrobbanhat.
- A készüléket rendszeresen tisztítani kell, és az ételmaradékokat el kell távolítani.
- A készülék tisztításához ne használjon nagy nyomású gőzt.
- Ne használjon súrolószert vagy éles fém kaparóeszközt a sütőajtó üvegének tisztítására, mivel ezek megkarcolhatják a felületet, ami az üveg megrepedését eredményezheti.
- A rendszeres tisztítás hiánya a felületek állapotának romlásához vezethet, ami káros befolyással lehet a készülék élettartamára, és veszélyes szituációhoz vezethet.

2. BIZTONSÁGI UTASÍTÁSOK

2.1 Üzembe helyezés

**FIGYELMEZTETÉS!**

A készüléket csak képesített személy helyezheti üzembe.

- Távolítsa el az összes csomagolóanyagot.
- Ne helyezzen üzembe, és ne is használjon sérült készüléket.
- Tartsa be a készülékhez mellékelte üzembe helyezési útmutatóban foglaltakat.
- A készülék nehéz, ezért legyen körültekintő a mozgatásakor. Mindig használjon munkavédelmi kesztyűt és zárt lábbelít.
- Soha ne húzza a készüléket a fogantyújánál fogva.
- A készüléket az üzembe helyezési követelményeknek megfelelő, biztonságos helyre telepítse.
- Tartsa meg a minimális távolságot a többi készüléktől és egységtől.
- A készülék felszerelése előtt ellenőrizze, hogy a sütő ajtaja akadálytalanul nyitható-e.
- A készülék elektromos hűtőrendszerrel van felszerelve. Ezt az elektromos tápegységgel kell működtetni.

BIZTONSÁGI UTASÍTÁSOK

- A beépíthető készüléknek meg kell felelnie a DIN 68930 stabilitási követelményeinek.

Konyhaszekrény minimális magassága (konyhaszekrény minimális magassága a munkalap alatt)	444 (460) mm
Konyhaszekrény szélessége	560 mm
Konyhaszekrény mélysége	550 (550) mm
Készülék elülső részének magassága	455 mm
Készülék hátulsó részének magassága	440 mm
Készülék elülső részének szélessége	595 mm
Készülék hátulsó részének szélessége	559 mm
Készülék mélysége	567 mm
Készülék beépített mélysége	546 mm
Mélység nyitott ajtónál	882 mm
Szellőzőnyílás minimális mérete. A hátsó oldal alján elhelyezett nyílás	560x20 mm
Hálózati tápkábel hosszúsága. A kábel a hátsó oldal jobb sarkánál helyezkedik el	1500 mm
Rögzítőcsavarok	3.5x25 mm

2.2 Elektromos csatlakozás

 FIGYELMEZTETÉS! Tűz- és áramütésveszély.

- Minden elektromos csatlakoztatást szakképzett villanyszerelőnek kell elvégeznie.
- A készüléket kötelező földelni.
- Ellenőrizze, hogy az adattáblán szereplő adatok megfelelnek-e a helyi elektromos hálózat paramétereinek.
- Mindig megfelelően felszerelt, áramütés ellen védett aljzatot használjon.
- Ne használjon hálózati elosztókat és hosszabbító kábeleket.
- Ügyeljen a hálózati csatlakozódugó és a hálózati kábel épségére. Amennyiben a készülék hálózati vezetékét ki kell cserélni, a cserét márkaszervizünknel végeztesse el.
- Ügyeljen arra, hogy a hálózati kábelek ne kerüljenek közel, illetve ne érjenek hozzá a készülék ajtajához vagy a készülék alatti rekeszhez, különösen akkor, ha a készülék működik, vagy ajtaja forró.

- A feszültség alatt álló és szigetelt alkatrészek érintésvédelmi részeit úgy kell rögzíteni, hogy szerszám nélkül ne lehessen eltávolítani azokat.
- Csak az üzembe helyezés befejezése után csatlakoztassa a hálózati csatlakozódugót a hálózati csatlakozóaljzatba. Ügyeljen arra, hogy a hálózati dugasz üzembe helyezés után is könnyen elérhető legyen.
- Amennyiben a hálózati konnektor rögzítése laza, ne csatlakoztassa a csatlakozódugót hozzá.
- A készülék csatlakozásának bontására, soha ne a hálózati kábelnél fogva húzza ki a csatlakozódugót. A kábelt mindig a csatlakozódugónál fogva húzza ki.
- Kizárólag megfelelő szigetelőberendezést alkalmazzon: hálózati túlterhelésvédő megszakítót, biztosítékot (a tokból eltávolított csavaros típusú biztosítékot), földzárlatkioldót és védőrelét.
- Az elektromos készüléket szigetelőberendezéssel kell ellátni, amely lehetővé teszi, hogy minden fázison leválassza a készüléket az elektromos hálózatról. A szigetelőberendezésnek legalább 3 mm-es érintkezőtávolsággal kell rendelkeznie.
- Ez a készülék hálózati csatlakozókábellel és dugasszal kerül szállításra.

2.3 Használat



FIGYELMEZTETÉS!

Sérülés-, égés-, áramütés- és robbanásveszély.

- Ne változtassa meg a készülék műszaki jellemzőit.
- Ügyeljen arra, hogy a szellőzőnyílásokat ne zárja el semmi.
- Működés közben ne hagyja felügyelet nélkül a készüléket.
- Minden használat után kapcsolja ki a készüléket.
- Körültekintően járjon el, ha működés közben kinyitja a készülék ajtaját. Forró levegő távozhat a készülékből.
- Ne működtesse a készüléket nedves kézzel, vagy amikor az vízzel érintkezik.
- Ne gyakoroljon nyomást a nyitott ajtóra.
- Ne használja a készüléket munka- vagy tárolófelületként.
- Óvatosan nyissa ki a készülék ajtaját. Az alkoholtartalmú alkotóelemek alkoholos levegőelegyet hozhatnak létre.
- Ügyeljen arra, hogy szikra vagy nyílt láng ne legyen a készülék közelében, amikor kinyitja az ajtót.
- Ne tegyen gyúlékony anyagot vagy gyúlékony anyaggal szennyezett tárgyat a készülékbe, annak közelébe, illetve annak tetejére.
- A sütő előmelegítéséhez ne használja a mikrohullám funkciót.



FIGYELMEZTETÉS!

A készülék károsodásának veszélye áll fenn.

- A zománc károsodásának vagy elszíneződésének megelőzéséhez:
 - ne tegyen alufóliát közvetlenül a készülék sütőterének aljára.
 - ne engedjen vizet a forró készülékbe.
 - a főzés befejezése után ne tárolja a nedves edényeket vagy az ételt a készülékben.
 - a tartozékok kivételekor vagy berakásakor óvatosan járjon el.
- A zománc vagy rozsdamentes acél elszíneződése nincs hatással a készülék teljesítményére.
- Főzés közben a készülék ajtaját mindig tartsa csukva.

- Ha a készüléket bútorlap (pl. ajtó) mögött helyezi el, ügyeljen arra, hogy az ajtó soha ne legyen becsukva, amikor a készülék működik. A hő és a nedvesség felhalmozódhat a zárt bútorlap mögött, és ennek következtében károsodhat a készülék, a készülék borítása vagy a padló. Használat után ne csukja be addig a bútorlapot, míg a készülék teljesen le nem hűlt.

2.4 Ápolás és tisztítás



FIGYELMEZTETÉS!

Személyi sérülés, tűz vagy a készülék károsodásának veszélye áll fenn.

- Karbantartás előtt kapcsolja ki a készüléket, és húzza ki a hálózati csatlakozódugót a csatlakozóaljzatból.
- Ellenőrizze, hogy lehűlt-e a készülék. Máskülönb fennáll a veszély, hogy az üveglapok eltörnek.
- A sütőajtó sérült üveglapját haladéktalanul cserélje ki. Forduljon a márkaszervizhez.
- Legyen óvatos, amikor az ajtót leszereli a készülékről. Az ajtó nehéz!
- Minden használat után törölje szárazra a sütőteret, a forgótányért és a sütőajtót. A készülék működése során képződött gőz lecsapódik a sütőtér falain és korróziót okozhat.
- Rendszeresen tisztítsa meg a készüléket, hogy elkerülje a felület károsodását.
- A mikrohullámú funkció működésekor a készülékben maradt zsír vagy étel tüzet és elektromos szikraképződést okozhat.
- A készüléket puha, nedves ruhával tisztítsa. Csak semleges tisztítószerrel használjon. Ne használjon súrolószert, súrolószivacsot, oldószert vagy fém tárgyat.
- Amennyiben sütőtisztító aeroszolt használ, tartsa be a tisztítószer csomagolásán feltüntetett biztonsági utasításokat.

2.5 Belső világítás



FIGYELMEZTETÉS!

Vigyázat! Áramütés-veszély!

- A termékben található izzó(k)ra és a külön kapható pótizzókra vonatkozó tudnivalók: Ezek az izzók arra készültek, hogy megfeleljenek a háztartási készülékekben fennálló szélsőséges fizikai feltételeknek, mint például hőmérséklet, rezgés, magas páratartalom, illetve arra használatosak, hogy jelezzék a készülék működési állapotát. Nem alkalmasak egyéb felhasználásra, valamint helyiségek megvilágítására.
- Ez a termék egy G energiahatékonysági osztályú fényforrást tartalmaz.
- Kizárólag az eredetivel megegyező műszaki jellemzőkkel rendelkező lámpát használjon.

2.6 Szolgáltatások

- A készülék javítását bízza a márkaszervizre.
- Mindig eredeti cserealkatrészt használjon.

2.7 Ártalmatlanítás



FIGYELMEZTETÉS!

Sérülés- vagy fulladásveszély.

- A készülék ártalmatlanítására vonatkozó tájékoztatásért lépjen kapcsolatba a helyi hatóságokkal.
- Válassza le a készüléket az elektromos hálózatról.
- A készülék közelében vágja át a hálózati kábelt, és tegye a hulladékba.

- Szerelje le az ajtókilincset, hogy megakadályozza gyermekek vagy háziállatok készülékben rekedését.

3. TERMÉKLEÍRÁS

3.1 Általános áttekintés

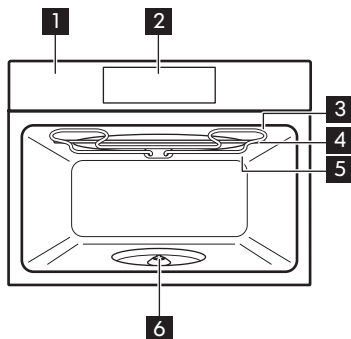

- 1** Kezelőpanel
- 2** Kijelző
- 3** Fűtőbetét
- 4** Mikrohullámú generátor
- 5** Lámpa

- 6** Forgótányér tengely

3.2 Tartozékok

Turntable készlet

Az étel elkészítéséhez.

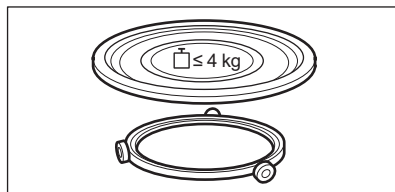

Grillrács készlet

Grillezéshez.

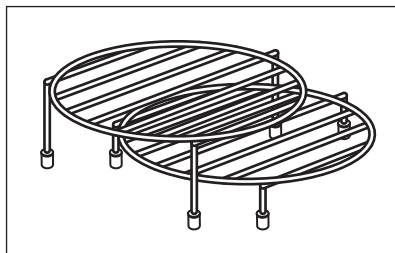

4. A SÜTŐ BE- ÉS KIKAPCSOLÁSA

4.1 Kezelőpanel

A SÜTŐ BE- ÉS KIKAPCSOLÁSA

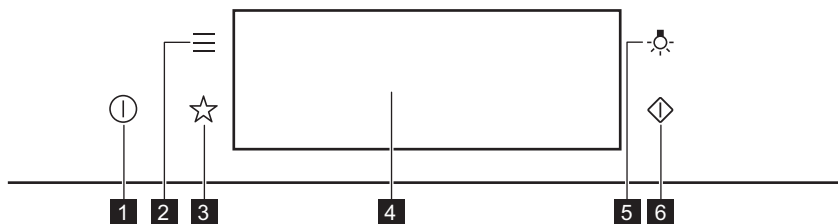



1	BE / KI	Tartsa nyomva a sütő be- és kikapcsolásához.
2	Menü	Sütőfunkciók listázása.
3	Kedvencek	Kedvenc beállítások listázása.
4	Kijelző	A sütő aktuális beállításait mutatja.
5	Világításkapcsoló	A sütővilágítás be- és kikapcsolása.
6	Mikrohullám gyorsindítás	A mikrohullám funkció bekapcsolása (1000 W teljesítmény 30 másodpercig).

 Nyomja meg a	 Áthelyezés	 Tartsa nyomva
Érintse meg ujjhegygel a felületet.	Húzza végig az ujját a felületen.	Érintse meg a felületet 3 másodpercig.

4.2 Kijelző





<p>The diagram shows a display area with the following elements: a power indicator (300W) with callout F, a menu icon with callout E, a grill icon with callout D, the word 'High' with callout C, and the time '12:34' with callout A. A 'START' button is located below the display with callout B.</p>	<p>Bekapcsolás után a kijelzőn megjelenik a fő képernyő a sütőfunkcióval és az alapértelmezett grillezési fokozattal.</p> <p>A. Pontos idő B. START/LEÁLLÍTÁS C. Grillezési fokozat D. Sütőfunkciók E. Mikrohullámú teljesítmény F. Időzítő</p>
---	--

AZ ELSŐ HASZNÁLAT ELŐTT

 12:34	A kijelző készenléti állapotba lép, ha 2 percen át nem használja a sütőt.
1000W  1m23s +30s STOP	Főzéskor a kijelző megjeleníti a beállított funkciókat és az egyéb rendelkezésre álló kiegészítő funkciókat.

Kijelző visszajelzői



Alapvető visszajelzők - a kijelzőn való mozgáshoz.

 Választás / beállítás megerősítése.	 Visszalépés egy szinttel a menüben.	 Az utolsó művelet visszavonása.	 A kiegészítő funkciók be- és kikapcsolása.
--	--	--	---

Figyelmeztető hangjelzés funkció visszajelzői - amikor a beállított főzési idő véget ér, hangjelzés hallható.

 A funkció be van kapcsolva.	 A funkció be van kapcsolva. A főzés automatikusan leáll.	 A figyelmeztető hangjelzés ki van kapcsolva.
--	--	---

Időzítő visszajelzők

 A funkció beállítása: Késleltetett indítás funkció.	 A beállítás törlése.
--	---

5. AZ ELSŐ HASZNÁLAT ELŐTT





FIGYELMEZTETÉS!

Lásd a „Biztonság” című fejezetet.

NAPI HASZNÁLAT

5.1 Kezdeti tisztítás

		
1. lépés	2. lépés	3. lépés
Vegyen ki minden tartozékot a sütőtérből.	Puha ruhával, langyos vízzel és enyhe mosogatószerrel tisztítsa meg a sütőt és a tartozékokat.	Helyezze a tartozékokat a sütőbe.

5.2 Első csatlakoztatás

Az első csatlakoztatás után a kijelzőn üdvözlő üzenet jelenik meg.

A következőket kell beállítania: Nyelv, Kijelző fényerő, Nyomógomb Hang, Figyelmeztető hangerő, Pontos idő.

6. NAPI HASZNÁLAT



FIGYELMEZTETÉS!

Lásd a „Biztonság” című fejezetet.

6.1 A következő funkció beállítása: Grill + mikro, Grill

A sütőből zaj szűrődhet ki ezen funkció működése közben: Grill + mikro. Ennél a funkciónál ez normális.

A következő funkció beállítása: Grill + mikro	
1. lépés	Helyezze be az alsó grillrácsot.
2. lépés	Kapcsolja be a sütőt. A kijelzőn megjelenik az alapértelmezett sütőfunkció.
3. lépés	Nyomja meg a sütőfunkció szimbólumát az almenübe lépéshez.
4. lépés	Válassza ki a következő funkciót:  Nyomja meg ezt: OK funkciót.
5. lépés	A grill intenzitási szintjének kiválasztása.
Funkció	Grillezési fokozat
Lo	Alacsony
Hi	Magas

A következő funkció beállítása: Grill + mikro	
6. lépés	Nyomja meg: OK funkciót.
7. lépés	Nyomja meg: START funkciót.
STOP - nyomja meg a sütő kikapcsolásához.	
8. lépés	Kapcsolja ki a sütőt.

A mikrohullám teljesítménye 500 Watra van korlátozva, ha ezt a funkciót használja: Grill + mikro funkciót.

A következő funkció beállítása: Grill	
1. lépés	Helyezze be a felső grillrácsot.
2. lépés	Kapcsolja be a sütőt. A kijelzőn megjelenik az alapértelmezett sütőfunkció.
3. lépés	Nyomja meg a sütőfunkció szimbólumát az almenübe lépéshez.
4. lépés	Válassza ki a következő funkciót:  . Nyomja meg ezt: OK funkciót.
5. lépés	A grill intenzitási szintjének kiválasztása.
Funkció	Grillezési fokozat
Lo	Alacsony
Hi	Magas
6. lépés	Nyomja meg: OK funkciót.
7. lépés	Nyomja meg: START funkciót.
STOP - a funkció kikapcsolásához nyomja meg.	
8. lépés	Kapcsolja ki a sütőt.

6.2 Mikrohullámú sütőfunkciók beállítása

1. lépés	Kapcsolja be a sütőt.
2. lépés	Nyomja meg a sütőfunkció szimbólumát az almenübe lépéshez.
3. lépés	Válassza ki a mikrohullám sütőfunkciót, majd nyomja meg ezt a gombot: OK . A kijelzőn ez látható: mikrohullámú teljesítmény.
4. lépés	Állítsa be a mikrohullámú teljesítményt. Nyomja meg: OK funkciót.
5. lépés	Nyomja meg: START funkciót.
STOP - a funkció kikapcsolásához nyomja meg.	
6. lépés	Kapcsolja ki a sütőt.

A mikrohullám funkciók maximális időtartama a beállított mikrohullámú teljesítménytől függ:

MIKROHULLÁMÚ TELJESÍTMÉNY	MAXIMÁLIS IDŐTARTAM
100 - 600 W	59 perc
Több mint 600 W	7 perc



Ha kinyitja az ajtót, a funkció leáll. Az ismételt elindításhoz nyomja meg a **START** gombot.

Használjon parancsikont!





6.3 Használata: Mikrohullám gyorsindítás

1. lépés	Tartsa megnyomva az alábbi gombot:  . A mikrohullám 30 másodpercig fog működni.
-----------------	--



2. lépés	A sütési idő meghosszabbítása:	
	Nyomja meg a futó időérték gombját az idő beállításba lépéshez. A sütési idő beállítása.	Nyomja meg a +30 s gombot.
A mikrohullám bármikor bekapcsolható ezzel: Mikrohullám gyorsindítás.		



6.4 Sütőfunkciók

HAGYOMÁNYOS

Sütőfunkció	Alkalmazás
 Grill	Vékony szelet élelmiszerek grillezéséhez és pirítás készítéséhez.
 Grill + mikro	Az ételek rövid ideig tartó főzéséhez és pirításához. Két grillezési intenzitás állítható be: alacsony és magas.
 Mikrohullám	Felmelegítés, főzés, teljesítmény-tartomány: 100 - 1000 W

MIKROHULLÁM

Sütőfunkció	Alkalmazás
 Kiolvasztás	Hús, hal, sütemény kiolvasztása, teljesítmény-tartomány: 100 - 200 W
 Olvasztás	Csokoládé és vaj olvasztása, teljesítmény-tartomány: 100 - 400 W
 Újramelegítés	Félkész és kényes ételek felmelegítéséhez. A teljesítmény tartománya: 300 - 700 W

Sütőfunkció	Alkalmazás
 Popcorn	Popcorn (pattogatott kukorica) készítése, teljesítmény-tartomány: 700 - 1000 W
 Folyadék	Italok és levesek felmelegítése, teljesítmény-tartomány: 800 - 1000 W

7. ÓRAFUNKCIÓK

7.1 Órafunkciók leírása

Órafunkció	Alkalmazás
Főzési idő	A sütés hosszúságának beállításához. Maximum 23 ó 59 perc.
Művelet befejezése	Segítségével beállítható, hogy mi történjen, amikor az időzítő befejezte a visszaszámlálást.
Idő kiterjesztés	A sütési idő meghosszabbítása.
Emlékeztető	Visszaszámlálás beállítása. Legfeljebb 23 ó 59 perc. Ez a funkció nincs hatással a sütő működésére.
Működésidőzítő	Megfigyeli, hogy milyen hosszban működik a funkció. Működésidőzítő - be- és kikapcsolható.

7.2 Órafunkciók beállítása

Az óra beállítása	
1. lépés	Nyomja meg: Pontos idő funkciót.
2. lépés	Állítsa be az időt. Nyomja meg: OK funkciót.

Főzési időtartam beállítása	
1. lépés	Válassza ki a sütőfunkciót.

Főzési időtartam beállítása

2. lépés	Nyomja meg:  funkciót.
3. lépés	Állítsa be az időt. Nyomja meg: OK funkciót.

A befejezés kiegészítő funkció kiválasztása

1. lépés	Válassza ki a sütőfunkciót.
2. lépés	Nyomja meg:  funkciót.
3. lépés	A sütési idő beállítása.
4. lépés	Nyomja meg: ● ● ● funkciót.
5. lépés	Nyomja meg: Művelet befejezése funkciót.
6. lépés	Válassza ki a megfelelő értékeket: Művelet befejezése funkciót.
7. lépés	Nyomja meg: OK . Addig ismétlje a műveletet, míg a fő képernyő meg nem jelenik a kijelzőn.

Főzési időtartam kiterjesztése

Ha a főzési időtartamból 10% maradt fenn, és az étel nem tűnik késznek, az időtartam meghosszabbítható. A sütőfunkciót is módosíthatja.

A sütési idő meghosszabbításához nyomja meg a **+1min** gombot.

Az időzítő beállításának módosítása

1. lépés	Nyomja meg:  funkciót.
2. lépés	Állítsa be az időzítési értéket.
3. lépés	Nyomja meg: OK funkciót.

A sütés alatt bármikor módosítható a beállított idő.

8. HOGYAN HASZNÁLJA: TARTOZÉKOK

8.1 Tartozékok behelyezése

Kizárólag megfelelő főzőedényeket és anyagokat használjon. Lásd a „Hasznos javaslatok és tanácsok” c. fejezet „Mikrohullámú sütőben használható edények és anyagok” szakaszát.

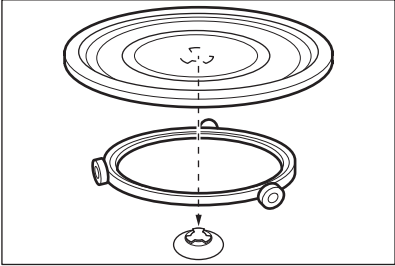
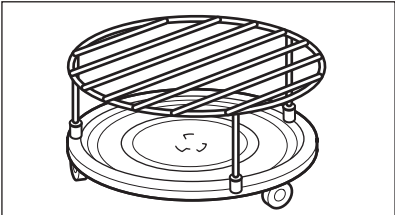
<p>Turntable készlet: Mindig a forgótányér készleten készítse az ételeket. Helyezze a tányérvezető görgőt a forgótányér-tengely köré. Helyezze az üveg forgótányért a tányérvezető görgőre. Csak a sütőhöz mellékelt forgótányér készletet használja.</p>	
<p>Grillrács készlet: A grillrácsot lefele néző szilikon sapkákkal helyezze a forgótányérra.</p>	

9. TOVÁBBI FUNKCIÓK

9.1 Hogyan mentheti: Kedvencek

Kedvenc beállításait, mint például a sütőfunkciót, a főzés időtartamát vagy a tisztítás funkciót eltárolhatja a készülék memóriájába. 3 kedvenc beállítás tárolható.



1. lépés	Kapcsolja be a sütőt.
2. lépés	Válassza ki a megfelelő beállítást.
3. lépés	Nyomja meg:  Válassza ezt: Kedvencek funkciót.
4. lépés	Válassza ezt: Aktuális beállítások mentése funkciót.
5. lépés	Nyomja meg a + gombot, hogy hozzáadja a beállítást a következők listájához: Kedvencek. Nyomja meg ezt: OK.

 - nyomja meg a beállítás visszaállításához.

 - nyomja meg a beállítás törléséhez.

9.2 Funkciózár

Ez a funkció megakadályozza a sütőfunkció véletlen megváltoztatását.

1. lépés	Kapcsolja be a sütőt.
2. lépés	Állítson be egy sütőfunkciót.
3. lépés	  - nyomja meg egyszerre a funkció bekapcsolásához.
A funkció kikapcsolásához ismételje meg a 3. lépést.	

9.3 Hűtőventilátor

Amikor a sütő üzemel, a hűtőventilátor automatikusan bekapcsol, hogy hidegen tartsa a sütő felületét. Amikor kikapcsolja a sütőt, a hűtőventilátor továbbra is működni fog, amíg a sütő le nem hűl.

10. HASZNOS TANÁCSOK ÉS JAVASLATOK

10.1 Sütési javaslatok



A táblázatban szereplő hőmérsékleti értékek és sütési időtartamok csak tájékoztatásként szolgálnak. Ezek a receptektől, valamint a felhasznált összetevők minőségétől és mennyiségétől függenek.

Előfordulhat, hogy az új sütő az Ön korábbi sütőjétől eltérően fog sütni. Az alábbi tanácsok a különféle ételekhez javasolt sütőfunkciókat és beállításokat tartalmazzák a különféle ételekhez.

Ha nem találja a beállításokat egy adott recepthez, akkor keressen hasonló ételt.

További sütési javaslatokért tekintse meg a weboldalunkon található sütési táblázatokat. A sütési javaslatok megkereséséhez tekintse meg a sütőtér elülső keretén található adattáblán szereplő termékszámot (PNC).

10.2 Javaslatok a mikrohullámú sütőhöz

Főzzünk!

Ne tegye az ételt közvetlenül a forgótányérra. Mindig mikrohullámú sütőben használható edényt helyezzen a készülékbe.

A főzőedényt a forgótányér közepére helyezze.

A túl forró vagy túl hideg edény/étel eltörheti forgótányért.

A kiolvasztási és főzési idő felénél fordítsa vagy keverje meg az ételt.

A folyékony ételeket időről időre keverje meg.

Tálalás előtt keverje meg az ételt.

Főzés és újramelegítés közben fedje le az ételt.

Italok melegítésekor tegyen egy kanalat a pohárba vagy üvegbe a jobb hőeloszlás érdekében. Csomagolás nélkül tegye az ételt a sütőbe. A csomagolt készételeket kizárólag akkor lehet berakni a sütőbe, ha a csomagolás mikrohullámú sütőben használható (ezzel kapcsolatban olvassa el a csomagoláson levő ismertetőt).



Mikrohullámú főzés

Az ételt lefedve készítse. Az ételt fedő nélkül készítse, ha a felületét szeretné kérgessé tenni. Túl magas teljesítményfokozat és túl hosszú időtartam esetén az étel túlfőhet. A túlmelegített étel kiszáradhat, eléghet vagy tüzet okozhat.

Ne használja a sütőt tojás vagy csiga saját héjában történő főzésére, mivel ezek felrobbanhatnak. Tükörtojás újramelegítése előtt lyukassza ki a tojássárgáját.

A héjas vagy bőrös ételeket főzés előtt szurkálja meg.

A zöldségeket vágja egyenlő darabokra.

A sütő kikapcsolása után vegye ki az ételt, és hagyja néhány percre pihenni, hogy a hő eloszlása egyenletes legyen.



Felolvasztás mikrohullámmal

Helyezze a fagyott, kicsomagolt ételt egy kicsi, felfordított tányérra, kiolvasztó állványra vagy műanyag szitára, amely alá helyezzen egy tálát, hogy ki tudjon folyni az olvadékvíz.

Ezt követően vegye ki a felolvasztott darabokat.

A zöldségek és gyümölcsök felolvasztás nélküli főzése magasabb mikrohullámú teljesítményfokozattal is végezhető.

10.3 Mikrohullámú sütőben használható főzőedények és anyagok





A mikrohullámú sütéshez kizárólag megfelelő főzőedényeket és anyagokat használjon.

Segédletként használja az alábbi táblázatot.

Használat előtt ellenőrizze a főzőedények / anyagok műszaki jellemzőit.

A főzőedény anyaga				
Tűzálló üveg és porcelán, amelyben nincs fém, pl. hőálló üveg	✓	✓	✓	✓
Nem tűzálló üveg és porcelán, ezüst-, arany-, platina- vagy egyéb fémdíszítés nélkül	✓	X	X	X
Üveg, valamint tűz- és fagyálló anyagból készült üvegkerámia	✓	✓	✓	✓



HASZNOS TANÁCSOK ÉS JAVASLATOK







A főzőedény anyaga				
Kerámia- és agyagedények kvarc- vagy fémkomponensek nélkül, illetve fémet is tartalmazó mázas edények	✓	✓	X	X
A kerámiából, porcelánból, agyagból vagy kőből készült főzőedényeken kis lyukak lehetnek, például a fogantyún vagy a mázolatlan talpon.	X	X	X	X
200 °C-ig hőálló műanyag	✓	✓	X	X
Karton, papír	✓	X	X	X
Háztartási fólia	✓	X	X	X
Sütőfólia mikrohullámú sütőbe helyezhető zárószalaggal	✓	✓	X	X
Fémről készült, pl. zománczott vagy öntöttvas edények	X	X	✓	X
Fekete mázas vagy szilikonos sütőformák	X	X	✓	X
Főzőedények mikrohullámú sütővel való használatra, pl. crisp tál	X	✓	X	X
Grillrács készlet	X	X	✓	✓

10.4 Különböző ételekhez javasolt teljesítmény-beállítások





A táblázatban szereplő adatok csak útmutatásul szolgálnak.

HASZNOS TANÁCSOK ÉS JAVASLATOK

800 - 1000 W	
 Pírtás a főzési folyamat elkezdésekor	 Folyadékok melegítése

500 - 700 W					
 Zöldségek párolása	 Rántotta sü-tése	 Pörkölt lassú forralása	 Rizs lassú forralása	 Egytálételek melegítése	 Mélyhűtött ételek felmelegítése és kiolvasztása



300 - 400 W		
 Sajt, csokoládé, vaj olvasztása	 Érzékeny élelmiszerek sütése / melegítése	 Sütés folytatása

100 - 200 W				
 Bébiétel melegítése	 Kenyér kiolvasztása	 Gyümölcs és sütemény kiolvasztása	 Sajt, tejszín, vaj kiolvasztása	 Hús, hal kiolvasztása





10.5 Ételkészítési táblázatok a bevizsgáló intézetek számára

Információ a bevizsgáló intézetek számára





Tesztek az IEC 60705 szabványnak megfelelően.

MIKROHULLÁMÚ FUNKCIÓ	POWER (W)	(kg)		(perc)	
Piskótateszta	600	0.475	Turntable készlet	5 - 7	-

ÁPOLÁS ÉS TISZTÍTÁS

MIKROHULLÁMÚ FUNKCIÓ	 POWER (W)	 (kg)		 (perc)	
Fasírt	500	0.9	Forgótá-nyér kész-let	18 - 20	-
Royale (sodó)	500	1	Turntable készlet	15 - 17	-
Hús kiolvasztása	200	0.5	Turntable készlet	8 - 9	-

Használja a következő funkciót: Mikrohullámú grill funkciót.
Használja az alsó grillrácsot.

KOMBINÁLT MIKRO-HULLÁM FUNKCIÓ	 POWER (W)	 Grillezési foko- zat	 (perc)	
Burgonyafelfűjt, 1,1 kg	300	alacsony	30 - 35	-
Csirke, 1,1 kg	300	magas	30 - 35	Helyezze a húst kerek üvegedény-be.

11. ÁPOLÁS ÉS TISZTÍTÁS





FIGYELMEZTETÉS!

Lásd a „Biztonság” című fejezetet.

11.1 Tisztítással kapcsolatos megjegyzések



 Tisztítósze- rek	A sütő elejét meleg vizes és enyhe mosogatószeres puha ruhával tisztítsa meg.
	A fémfelületeket háztartási tisztítószerrel tisztítsa meg.
	A szennyeződések elenyévesztését enyhe mosogatószerrel távolítsa el.



 <p>Napi használálat</p>	<p>A sütőteret minden használat után tisztítsa meg. A lerakódott zsír vagy egyéb maradvány tüzet okozhat. Körültekintően tisztítsa meg a sütőtér mennyezetét az ételmaradványoktól és a zsírtól.</p>
 <p>Tartozékok</p>	<p>Minden használat után tisztítsa és szárítsa meg az összes tartozékot. Tisztítás előtt várja meg, hogy a forgótányér lehűljön. Fennáll a veszély, hogy a forgótányér eltörik. Puha ruhával, langyos vízzel és enyhe mosogatószerrel végezze az tisztítást. A tartozékokat tilos mosogatógépben tisztítani.</p> <p>A teflon bevonatos tartozékokat ne tisztítsa súroló hatású tisztítószerrel vagy éles tárgyakkal.</p>

12. HIBAELHÁRÍTÁS

	<p>FIGYELMEZTETÉS! Lásd a „Biztonság” című fejezetet.</p>
--	--

12.1 Mi a teendő, ha...



 <p>A sütő nem kapcsol be vagy nem melegszik fel</p>	
 <p>Lehetséges ok</p>	 <p>Megoldás</p>
<p>A sütő nincs csatlakoztatva az elektromos hálózathoz, vagy nincs megfelelően csatlakoztatva.</p>	<p>Ellenőrizze, hogy a sütő megfelelően van-e csatlakoztatva az elektromos hálózathoz.</p>
<p>Az óra nincs beállítva.</p>	<p>Állítsa be az órát. A részletekért olvassa el az „Óra funkciók” fejezet „Hogyan állítsa be:” című szakaszát Órafunkciók funkciót.</p>
<p>Az ajtó nem csukódik rendesen.</p>	<p>Teljesen zárja be az ajtót.</p>
<p>Leolvadt a biztosíték.</p>	<p>Ellenőrizze, hogy nem a biztosíték okozza-e a hibát. Ha a hiba többször előfordul, hívjon szakképzett villanszerelőt.</p>
<p>A sütőn a Gyerekzár be van kapcsolva.</p>	<p>Olvassa el a „Menü” c. fejezetben ezt az almenüt: Egyéb funkciók funkciót.</p>

 Alkotóelemek	
 Leírás	 Megoldás
Kiégett az izzó.	Cserélje ki az izzót. A részletekért olvassa el az „Ápolás és tisztítás” fejezetben ezt a szakaszt: Hogyan cserélje: Lámpa.
A forgótányér készlet zajos.	Ételmaradék található a forgótányér készlet alatt.

12.2 Hogyan kezelje: Hibakódok

Szoftverhiba esetén a kijelzőn hibaüzenet látható.

Ebben a szakaszban az olyan hibák listáját láthatja, melyeket saját maga is képes kezelni.

 Kód és leírás	 Javítási mód
F240, F439 - a kijelző érzékelőmezői nem működnek megfelelően.	Tisztítsa meg a kijelző felületét. Ügyeljen arra, hogy ne maradjon szennyeződés az érzékelőmezőkön.
F908 - a sütő rendszere nem tud csatlakozni a kezelőpanelhez.	Kapcsolja ki és be a sütőt.

12.3 A szerviz számára szükséges adatok

Ha nem talál megoldást egyedül a problémára, forduljon a márkakereskedőhöz vagy a hivatalos márkaszervizhez.

A márkaszerviz számára szükséges adatok az adattáblán találhatóak. Az adattábla a sütőtér elülső keretén található. Ne távolítsa el az adattáblát a készülék sütőterének keretéről.

Javasoljuk, hogy írja ide az adatokat:	
Modell (Mod.)
Termékszám (PNC)
Sorozatszám (S.N.)

13. ENERGIAHATÉKONYSÁG

13.1 Energiatakarékosság



A sütő több funkcióval is segít energiát megtakarítani a mindennapos főzés során.

Ügyeljen rá, hogy használat közben a sütő ajtaja be legyen csukva. Sütés közben ne nyissa ki túl gyakran a sütő ajtaját. Tartsa tisztán az ajtótomítést, és ügyeljen rá, hogy megfelelően legyen a helyére rögzítve.

Amikor lehetséges, kerülje a sütő előmelegítését.

Ha egyszerre több ételt készít, a sütések közötti szünet legyen a lehető legrövidebb.

Sütés kikapcsolt sütővilágítással

Sütés közben kapcsolja ki a sütővilágítást. Csak akkor kapcsolja be, amikor szükség van rá.

14. A MENÜ FELÉPÍTÉSE

14.1 Menü

Nyomja meg a  gombot a Menü megnyitásához.

Menüpont		Alkalmazás
Kedvencek		Kedvenc beállítások listázása.
Egyéb funkciók		A sütőparaméterek beállítása.
Beállítások	Beállítás	A sütőparaméterek beállítása.
	Szervíz	A szoftver verziószám és a konfiguráció megjelenítése.

14.2 Almenü ehhez: Egyéb funkciók

Almenü	Alkalmazás
Sütő világítás	A sütővilágítás be- és kikapcsolása.
Gyerekszár	Megakadályozza a sütő véletlen bekapcsolását. Ha a kiegészítő funkció be van kapcsolva, a „Gyerekszár” kijelzés megjelenik a kijelzőn a sütő bekapcsolásakor. A sütő használatához válassza ki a kód betűit ábécé sorrendben. Bekapcsolt gyerekszár mellett is hozzáférhető az időzítő, a távirányítás és a sütővilágítás.
Idő kijelzés	Az óra be- és kikapcsolása.

Almenü	Alkalmazás
Digitális óra stílus	Az időkijelzés formátumának módosítása.

14.3 Almenü ehhez: Beállítás

Almenü	Megnevezés
Nyelv	A kívánt nyelv beállítása.
Kijelző fényerő	A kijelző fényerejének beállítása.
Nyomógomb Hang	Az érintőmezők hangjának be- és kikapcsolása. A hang elnémítása nem lehetséges a következőnél: ① funkciót.
Figyelmeztető hangerő	A gombnyomások és jelzések hangerejének beállítása.
Pontos idő	A pontos idő és dátum beállítása.

14.4 Almenü a következőhöz: Szervíz

Almenü	Leírás
Demo üzemmód	Aktiváló / inaktíváló kód: 2468
Szoftver verzió	Szoftver verzióra vonatkozó információk.
Összes beállítás törlése	Visszaállítás gyári beállításokra.

15. EGYSZERŰ!

Az első használat előtt be kell állítania az alábbiakat:				
Nyelv	Kijelző fényerő	Nyomógomb Hang	Figyelmeztető hangerő	Pontos idő

EGYSZERŰ!

Ismerkedjen meg a kezelőpanelen és a kijelzőn található alapvető ikonokkal:

 BE / KI	 Menü	 Kedvencek	 Időzítő	START / STOP
--	---	--	--	--------------

A sütő használatának megkezdése

MW gyors indítása	A mikrohullámú működést bármikor elindíthatja az alapértelmezett beállításokkal: 30 másodperc / 1000 W.	Nyomja meg:  funkciót.
--------------------------	---	---



			
melegítés / sütés 100 - 1000 W	sütés / pirítás intenzitás: alacsony / magas	sütés / pirítás	folyadékok melegítése 800 - 1000 W
			
újramelegítés 300 - 700 W	kiolvasztás 100 - 200 W	olvasztás 100 - 400 W	pattogatott kukorica készítése 700 - 1000 W

A mikrohullámú beállításai		Mikrohullám tanácsok
Mikrohullámú teljesítmény:	Maximális időtartam:	Főzés és újramelegítés közben fedje le az ételt. A kiolvasztási és főzési idő felénél fordítsa vagy keverje meg az ételt. Tegye a kanalat az edénybe, amikor folyadékot melegít. Csomagolás nélkül tegye az ételt a sütőbe (kivéve, ha az mikrohullámálló).
100 - 600 W	59 perc	
> 600 W	7 perc	

Főzés elindítása

1. lépés	2. lépés	3. lépés	4. lépés	5. lépés
-----------------	-----------------	-----------------	-----------------	-----------------



Főzés elindítása

 - nyomja meg a sütő bekapcsolásához.	 ... - válassza ki a funkciót.	W - állítsa be a mikrohullámú teljesítményt.	OK - nyomja meg a megerősítéshez.	START - nyomja meg a főzés elindításához.
---	--	--	---	---

A sütés időtartamának beállításához használja a gyors funkciókat

10% befejezési segéd Használja a 10% befejezési segédet, hogy további időtartamot adjon hozzá, amikor a főzési időből 10% maradt fenn.	A sütési idő meghosszabbításához nyomja meg a +1min gombot.
--	--

16. KÖRNYEZETVÉDELMI TUDNIVALÓK

A  következő jelzéssel ellátott anyagokat hasznosítsa újra. Újrahasznosításhoz tegye a megfelelő konténerekbe a csomagolást. Járuljon hozzá környezetünk és egészségünk védelméhez, és hasznosítsa újra az elektromos és elektronikus hulladékot. A  tiltó szimbólummal ellátott készüléket ne dobja a háztartási hulladék közé. Juttassa el a készüléket a helyi újrahasznosító telepre, vagy lépjen kapcsolatba a hulladékkezelésért felelős hivatallal.

PER RISULTATI PERFETTI

Grazie per aver scelto di acquistare questo prodotto AEG. Lo abbiamo creato per fornirvi prestazioni impeccabili per molti anni, grazie a tecnologie innovative che vi semplificheranno la vita - funzioni che non troverete sulle normali apparecchiature. Vi invitiamo di dedicare qualche minuto alla lettura per sapere come trarre il massimo dal vostro elettrodomestico.

Visitate il nostro sito web per:



Ricevere consigli, scaricare i nostri opuscoli, eliminare eventuali anomalie, ottenere informazioni sull'assistenza e la riparazione:

www.aeg.com/support



Per registrare il vostro prodotto e ricevere un servizio migliore:

www.registreaeg.com



Acquistare accessori, materiali di consumo e ricambi originali per la vostra apparecchiatura:

www.aeg.com/shop

ASSISTENZA CLIENTI E ASSISTENZA TECNICA

Consigliamo sempre l'impiego di ricambi originali.

Quando si contatta il nostro Centro di Assistenza Autorizzato, accertarsi di avere a disposizione i dati seguenti: Modello, numero dell'apparecchio (PNC), numero di serie.

Le informazioni sono riportate sulla targhetta identificativa.

 Avvertenza/Attenzione - Importanti Informazioni per la sicurezza

 Informazioni generali e suggerimenti

 Informazioni ambientali

Con riserva di modifiche.

INDICE

1. INFORMAZIONI DI SICUREZZA.....	211	3.2 Accessori.....	218
1.1 Sicurezza di bambini e persone vulnerabili.....	211	4. COME ACCENDERE E SPEGNERE IL FORNO.....	219
1.2 Avvertenze di sicurezza generali.....	212	4.1 Pannello dei comandi.....	219
2. ISTRUZIONI DI SICUREZZA.....	214	4.2 Display.....	220
2.1 Installazione.....	214	5. PRIMA DEL PRIMO UTILIZZO.....	221
2.2 Collegamento elettrico.....	215	5.1 Pulizia iniziale	221
2.3 Utilizzo:.....	216	5.2 Prima connessione.....	221
2.4 Pulizia e cura.....	217	6. UTILIZZO QUOTIDIANO.....	221
2.5 Illuminazione interna.....	217	6.1 Come impostare la funzione: Grill + Microonde, Grill.....	221
2.6 Assistenza.....	218	6.2 Come impostare: Funzioni cottura microonde.....	224
2.7 Smaltimento.....	218		
3. DESCRIZIONE DEL PRODOTTO.....	218		
3.1 Panoramica generale.....	218		

6.3 Istruzioni d'uso: Avvio rapido del microonde.....	224	10.5 Tabelle di cottura per gli istituti di test.....	233
6.4 Funzioni cottura.....	225	11. PULIZIA E CURA.....	234
7. FUNZIONI DEL TIMER.....	226	11.1 Note sulla pulizia.....	234
7.1 Descrizione funzioni orologio.....	226	12. RISOLUZIONE DEI PROBLEMI.....	235
7.2 Come impostare: Funzioni Orologio.....	226	12.1 Cosa fare se.....	235
8. COME USARE: ACCESSORI.....	228	12.2 Come gestire: Codici di errore...	236
8.1 Inserimento di accessori.....	228	12.3 Dati dell'Assistenza.....	236
9. FUNZIONI AGGIUNTIVE.....	229	13. EFFICIENZA ENERGETICA.....	237
9.1 Come salvare: Preferiti.....	229	13.1 Risparmio energetico.....	237
9.2 Blocco tasti.....	229	14. STRUTTURA DEL MENU.....	237
9.3 Ventola di raffreddamento.....	230	14.1 Menu.....	237
10. CONSIGLI E SUGGERIMENTI UTILI....	230	14.2 Sottomenu per: Opzioni.....	237
10.1 Consigli di cottura.....	230	14.3 Sottomenu per: Configurazione.	238
10.2 Consigli per l'uso del microonde	230	14.4 Sottomenu per: Assistenza tecnica.....	238
10.3 Pentole e materiali adatti per un uso in microonde	231	15. È SEMPLICE!.....	239
10.4 Impostazioni di potenza consigliate per diverse tipologie di cibo.....	232	16. CONSIDERAZIONI SULL'AMBIENTE..	240

1. ⚠ INFORMAZIONI DI SICUREZZA

Leggere attentamente le istruzioni fornite prima di installare e utilizzare l'apparecchiatura. I produttori non sono responsabili di eventuali lesioni o danni derivanti da un'installazione o un uso scorretti. Conservare sempre le istruzioni in un luogo sicuro e accessibile per poterle consultare in futuro.

1.1 Sicurezza di bambini e persone vulnerabili

- Quest'apparecchiatura può essere usata da bambini a partire da 8 anni di età e da adulti con capacità fisiche, sensoriali o mentali limitate o con scarsa esperienza e conoscenza sull'uso dell'apparecchiatura, solamente se sorvegliati o se istruiti relativamente all'utilizzo in sicurezza dell'apparecchiatura e se hanno compreso i rischi coinvolti. I bambini che hanno meno di 8 anni e le persone con disabilità diffuse e complesse vanno tenuti lontani

dall'elettrodomestico, a meno che non vi sia una supervisione continua.

- I bambini devono essere sorvegliati per assicurarsi che non giochino con l'apparecchiatura.
- Tenere gli imballaggi lontano dai bambini e smaltirli in modo adeguato.
- **AVVERTENZA:** Tenere i bambini e gli animali domestici lontani dall'elettrodomestico durante il funzionamento o il raffreddamento. Le parti accessibili si riscaldano molto durante l'uso.
- Se l'elettrodomestico ha un dispositivo di sicurezza per i bambini sarà opportuno attivarlo.
- I bambini non devono eseguire interventi di pulizia e manutenzione sull'elettrodomestico senza essere supervisionati.

1.2 Avvertenze di sicurezza generali

- L'apparecchiatura è destinata solo alla cottura.
- Quest'apparecchiatura è progettata per un uso domestico singolo in un ambiente interno.
- Quest'apparecchiatura può essere utilizzata in uffici, camere d'albergo, camere di bed & breakfast, alloggi in agriturismi e altre sistemazioni simili in cui tale utilizzo non superi i livelli di utilizzo domestico (medi).
- L'installazione dell'apparecchiatura e la sostituzione dei cavideve essere effettuata unicamente da personale qualificato.
- Non utilizzare l'apparecchiatura prima di installarla nella struttura a incasso.
- Prima di ogni operazione di manutenzione, scollegare l'apparecchiatura dall'alimentazione elettrica.
- Se il cavo di alimentazione è danneggiato, deve essere sostituito dal produttore, da un centro di assistenza tecnica autorizzato o da una persona qualificata per evitare situazioni di pericolo elettrico.

- **AVVERTENZA:** Assicurarsi che l'elettrodomestico sia spento prima di sostituire la lampadina per evitare la possibilità di scosse elettriche.
- **AVVERTENZA:** L'elettrodomestico e le parti accessibili si riscaldano molto durante l'uso. Fare attenzione a non toccare gli elementi riscaldanti.
- Utilizzare sempre guanti da forno per rimuovere o inserire accessori o pirofile.
- Usare esclusivamente il piatto girevole e il relativo supporto in dotazione con l'apparecchiatura.
- Non attivare la funzione Microonde quando l'apparecchiatura è vuota. Le parti metalliche all'interno della cavità possono generare scintille elettriche.
- I contenitori metallici per alimenti e bevande non sono ammessi durante la cottura a microonde. Questo requisito non è applicabile se il produttore specifica dimensioni e forma dei contenitori metallici adatti per la cottura a microonde.
- **AVVERTENZA:** Se lo sportello o le guarnizioni dello sportello sono danneggiate, l'apparecchiatura non deve essere messa in funzione finché non è stata riparata da una persona qualificata.
- **AVVERTENZA:** Qualsiasi intervento di manutenzione o riparazione che riguardi la rimozione di un coperchio che garantisca protezione contro l'esposizione all'energia del microonde deve essere eseguito solo da una persona qualificata.
- **AVVERTENZA:** Non riscaldare liquidi e altri alimenti in contenitori sigillati. Possono esplodere.
- Usare solo utensili adatti all'uso nei forni a microonde.
- Quando si riscaldano alimenti in recipienti di plastica o carta, controllare l'apparecchiatura per evitare il rischio d'incendio.
- L'apparecchiatura è destinata alla cottura di alimenti e bevande. L'asciugatura di alimenti o indumenti e il riscaldamento di cuscini riscaldanti, pantofole, spugne,

ISTRUZIONI DI SICUREZZA

panni umidi e simili può comportare il rischio di lesioni o incendio.

- Se viene emesso del fumo, spegnere o scollegare l'apparecchiatura e tenere la porta chiusa per spegnere le eventuali fiamme.
- Il riscaldamento a microonde di bevande può provocare un'ebollizione ritardata con fuoriuscita del liquido. Prestare attenzione quando si manipola il contenitore.
- I contenuti dei biberon e degli omogeneizzati devono essere mescolati o agitati e la temperatura deve essere controllata prima del consumo, per evitare ustioni.
- Le uova nel guscio e le uova sode non devono essere riscaldate nell'apparecchiatura in quanto potrebbero esplodere, anche dopo il termine del riscaldamento a microonde.
- L'apparecchiatura deve essere pulita regolarmente e devono essere rimossi eventuali residui di cibo.
- Non utilizzare vaporelle per pulire l'elettrodomestico.
- Non utilizzare detergenti abrasivi o raschietti di metallo per pulire il vetro dello sportello per non rigare la superficie e causare la rottura del vetro.
- La mancata pulizia dell'apparecchiatura può comportare un deterioramento della superficie che potrebbe influire negativamente sulla durata dell'apparecchiatura e comportare situazioni di pericolo.

2. ISTRUZIONI DI SICUREZZA

2.1 Installazione



AVVERTENZA!

L'installazione dell'apparecchiatura deve essere eseguita da personale qualificato.

- Rimuovere tutti i materiali di imballaggio.
- Non installare o utilizzare l'apparecchiatura se è danneggiata.
- Attenersi alle istruzioni fornite insieme all'apparecchiatura.
- Prestare sempre attenzione in fase di spostamento dell'apparecchiatura, dato che è pesante. Usare sempre i guanti di sicurezza e le calzature adeguate.
- Non tirare l'apparecchiatura per la maniglia.

- Installare l'apparecchiatura in un luogo sicuro e idoneo che soddisfi i requisiti di installazione.
- È necessario rispettare la distanza minima dalle altre apparecchiature.
- Prima di montare l'apparecchiatura controllare che la porta del forno si apra senza limitazioni.
- L'apparecchiatura è dotata di un sistema di raffreddamento elettrico. Quest'ultimo funziona a corrente elettrica.
- L'unità a incasso deve soddisfare i requisiti di stabilità DIN 68930.

Altezza minima del mobiletto (mobiletto sotto all'altezza minima del piano di lavoro)	444 (460) mm
Larghezza del mobiletto	560 mm
Profondità del mobiletto	550 (550) mm
Altezza della parte anteriore dell'apparecchiatura	455 mm
Altezza della parte posteriore dell'apparecchiatura	440 mm
Larghezza della parte anteriore dell'apparecchiatura	595 mm
Larghezza della parte posteriore dell'apparecchiatura	559 mm
Profondità dell'apparecchiatura	567 mm
Profondità di incasso dell'apparecchiatura	546 mm
Profondità con porta aperta	882 mm
Dimensioni minime dell'apertura di ventilazione. Apertura collocata sul lato posteriore inferiore	560x20 mm
Lunghezza del cavo di alimentazione. Il cavo è collocato nell'angolo destro del lato posteriore	1500 mm
Viti di montaggio	3.5x25 mm

2.2 Collegamento elettrico



AVVERTENZA!

Rischio di incendio e scossa elettrica.

- Tutti i collegamenti elettrici devono essere realizzati da un elettricista qualificato.
- L'apparecchiatura deve disporre di una messa a terra.

ISTRUZIONI DI SICUREZZA

- Verificare che i parametri sulla targhetta siano compatibili con le indicazioni elettriche dell'alimentazione.
- Utilizzare sempre una presa elettrica con contatto di protezione correttamente installata.
- Non utilizzare prese multiple e prolunghe.
- Accertarsi di non danneggiare la spina e il cavo. Qualora il cavo elettrico debba essere sostituito, l'intervento dovrà essere effettuato dal nostro Centro di Assistenza autorizzato.
- Evitare che i cavi entrino a contatto o si trovino vicino alla porta dell'apparecchiatura o sulla nicchia sotto all'apparecchiatura, in particolare quando il dispositivo è in funzione o la porta è calda.
- I dispositivi di protezione da scosse elettriche devono essere fissati in modo tale da non poter essere disattivati senza l'uso di attrezzi.
- Inserire la spina di alimentazione nella presa solo al termine dell'installazione. Verificare che la spina di alimentazione rimanga accessibile dopo l'installazione.
- Nel caso in cui la spina di corrente sia allentata, non collegarla alla presa.
- Non tirare il cavo di alimentazione per scollegare l'apparecchiatura. Tirare sempre dalla spina.
- Servirsi unicamente di dispositivi di isolamento adeguati: interruttori automatici, fusibili (quelli a tappo devono essere rimossi dal portafusibile), sganciatori per correnti di guasto a terra e relè.
- L'impianto elettrico deve essere dotato di un dispositivo di isolamento che consenta di scollegare l'apparecchiatura dalla presa di corrente a tutti i poli. Il dispositivo di isolamento deve avere una larghezza dell'apertura di contatto non inferiore ai 3 mm.
- La dotazione standard dell'apparecchiatura al momento della fornitura prevede una spina e un cavo di rete.

2.3 Utilizzo:



AVVERTENZA!

Rischio di lesioni, ustioni, scosse elettriche o esplosioni.

- Non modificare le specifiche tecniche dell'apparecchiatura.
- Assicurarsi che le aperture di ventilazione non siano bloccate.
- Non lasciare l'elettrodomestico incustodito durante il funzionamento.
- Spegnerne l'elettrodomestico dopo ogni utilizzo.
- Prestare attenzione in fase di apertura dello sportello dell'elettrodomestico, quando quest'ultimo è in funzione. Può esservi un rilascio di aria calda.
- Non accendere l'elettrodomestico con le mani bagnate o quando è a contatto con l'acqua.
- Non esercitare pressione sullo sportello aperto.
- Non utilizzare l'elettrodomestico come superficie di lavoro o come superficie di deposito.
- Aprire lo sportello dell'elettrodomestico attentamente. L'utilizzo di ingredienti con alcol può provocare una miscela di alcol e aria.
- Non lasciare scintille o fiamme libere a contatto con l'elettrodomestico quando si apre lo sportello.
- Non appoggiare o tenere liquidi o materiali infiammabili, né oggetti facilmente infiammabili sull'apparecchiatura, al suo interno o nelle immediate vicinanze.
- Non usare la funzione microonde per preriscaldare il forno.



AVVERTENZA!

Vi è il rischio di danneggiare l'apparecchiatura.

- Per evitare danni o lo scolorimento dello smalto:

- Non collocare la pellicola di alluminio direttamente sul fondo della cavità dell'elettrodomestico.
- Non versare acqua direttamente all'interno dell'elettrodomestico caldo.
- Non conservare piatti e alimenti umidi all'interno dell'elettrodomestico dopo aver terminato la cottura.
- Prestare attenzione in fase di rimozione o installazione degli accessori.
- Lo scolorimento dello smalto o dell'acciaio inox non influisce sulle prestazioni dell'elettrodomestico.
- Eseguire sempre la cottura con lo sportello dell'apparecchiatura chiuso.
- Se l'apparecchiatura si trova dietro a un pannello anteriore (ad es. una porta), assicurarsi che questo non sia mai chiuso quando l'apparecchiatura è in funzione. Calore e umidità possono accumularsi sul retro di un pannello chiuso causando danni all'apparecchiatura, all'alloggiamento o al pavimento. Dopo l'uso non chiudere il pannello dell'armadio finché l'apparecchiatura non si è completamente raffreddata.

2.4 Pulizia e cura



AVVERTENZA!

Vi è il rischio di lesioni, incendio o danni all'apparecchiatura.

- Prima di eseguire qualunque intervento di manutenzione, spegnere l'apparecchiatura ed estrarre la spina dalla presa.
- Controllare che l'apparecchiatura sia fredda. Vi è il rischio che i pannelli in vetro si rompano.
- Sostituire immediatamente i pannelli in vetro della porta nel caso in cui siano danneggiati. Contattare il Centro Assistenza Autorizzato.
- Prestare attenzione quando si rimuove la porta dall'apparecchio. La porta è pesante!
- Assicurarsi che la cavità, il piatto girevole e la porta siano asciutte dopo ogni utilizzo. Il vapore prodotto durante il funzionamento dell'apparecchiatura crea una condensa sulle pareti della cavità e potrebbe causarne la corrosione.
- Pulire regolarmente l'apparecchiatura per evitare il deterioramento dei materiali che compongono la superficie.
- Il grasso e gli alimenti che restano nell'apparecchiatura possono causare incendio e ustione quando viene attivata la funzione microonde.
- Pulire l'apparecchiatura con un panno inumidito e morbido. Utilizzare solo detersivi neutri. Non usare prodotti abrasivi, spugnette abrasive, solventi od oggetti metallici.
- Se si utilizza uno spray per il forno, seguire attentamente le istruzioni di sicurezza sulla confezione.

2.5 Illuminazione interna



AVVERTENZA!

Pericolo di scosse elettriche.

- Per quanto riguarda la lampada o le lampade all'interno di questo prodotto e le lampade di ricambio vendute separatamente: Queste lampade sono destinate a resistere a condizioni fisiche estreme negli elettrodomestici, come temperatura, vibrazioni, umidità, o sono destinate a segnalare informazioni sullo stato operativo dell'apparecchio. Non sono destinate ad essere utilizzate in altre applicazioni e non sono adatte per l'illuminazione di ambienti domestici.
- Questo prodotto contiene una sorgente luminosa di classe di efficienza energetica G.
- Servirsi unicamente di lampadine con le stesse specifiche tecniche .

DESCRIZIONE DEL PRODOTTO

2.6 Assistenza

- Per far riparare l'apparecchiatura, rivolgersi a un Centro di Assistenza Autorizzato.
- Utilizzare solo ricambi originali.

2.7 Smaltimento



AVVERTENZA!

Rischio di lesioni o soffocamento.

- Contattare le autorità locali per ricevere informazioni su come smaltire correttamente l'apparecchiatura.
- Staccare la spina dall'alimentazione elettrica.
- Tagliare il cavo elettrico dell'apparecchiatura e smaltirlo.
- Togliere il blocco porta per evitare che bambini, o animali restino intrappolati nell'apparecchiatura.

3. DESCRIZIONE DEL PRODOTTO

3.1 Panoramica generale

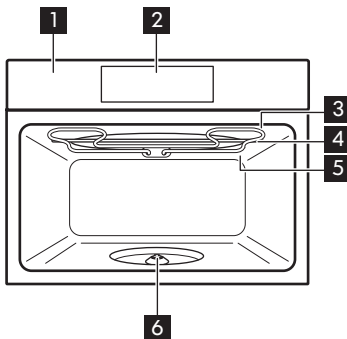

- 1 Pannello dei comandi
- 2 Display
- 3 Resistenza
- 4 Generatore microonde
- 5 Lampadina

- 6 Albero turntable

3.2 Accessori

Kit turntable

Per preparare cibi.

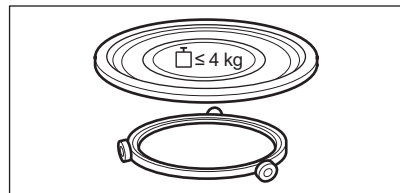

COME ACCENDERE E SPEGNERE IL FORNO

Set griglia per il grill

Per grigliare.

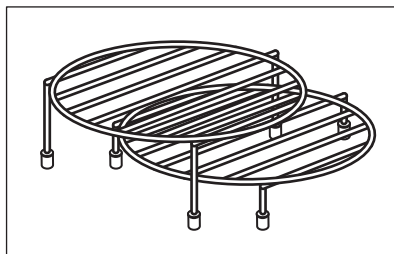

4. COME ACCENDERE E SPEGNERE IL FORNO

4.1 Pannello dei comandi

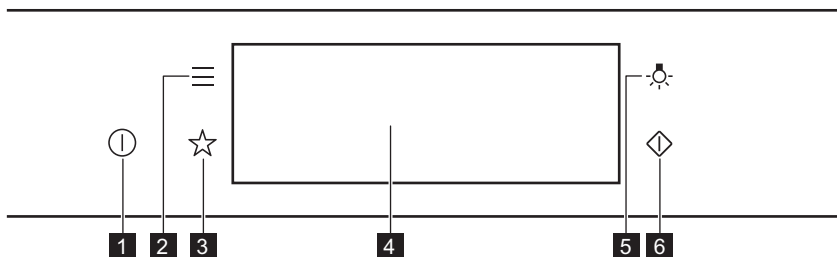

1	Si / No	Tenere premuto per accendere o spegnere il forno.
2	Menu	Uso delle funzioni del forno.
3	Preferiti	Elenca le impostazioni preferite.
4	Display	Visualizza le impostazioni del forno.
5	Interruttore lampadina	Per accendere e spegnere la lampadina.
6	Avvio rapido del microonde	Per accendere la funzione microonde (1000 W e 30 secondi).



Premere



Spostare



Tenere premuto

COME ACCENDERE E SPEGNERE IL FORNO





Toccare la superficie con la punta del dito.	Far scivolare la punta della dita sulla superficie.	Toccare la superficie per 3 secondi.
--	---	--------------------------------------

4.2 Display

	<p>Dopo l'accensione, il display mostra la schermata principale con la funzione e l'intensità predefinita del grill.</p> <p>A. Imposta ora B. START/STOP C. Intensità del grill D. Funzioni cottura E. Potenza microonde F. Timer</p>
	<p>Qualora il forno non venga usato per 2 minuti, il display passa in modalità standby.</p>
	<p>Quando si cucina, il display mostra le funzioni impostate e altre opzioni disponibili.</p>

Spie display			
Indicatori di base - per spostarsi sul display.			
<p>OK</p> <p>Per confermare la selezione / l'impostazione.</p>	<p><</p> <p>Per tornare indietro di un livello nel menu.</p>	<p>↶</p> <p>Per annullare l'ultima azione.</p>	<p>☑</p> <p>Per attivare o disattivare le opzioni.</p>
indicatori funzione Suono allarme - al termine del tempo di cottura impostato viene emesso un segnale acustico.			

PRIMA DEL PRIMO UTILIZZO

 La funzione è attiva.	 La funzione è attiva. La cottura si arresta automaticamente.	 Il suono allarme è disattivato.
Spie timer		
 Per impostare la funzione: Partenza ritardata.	 Per annullare l'impostazione.	



5. PRIMA DEL PRIMO UTILIZZO



AVVERTENZA!

Fare riferimento ai capitoli sulla sicurezza.

5.1 Pulizia iniziale

		
Passaggio 1	Passaggio 2	Passaggio 3
Rimuovere tutti gli accessori dal forno.	Pulire il forno e gli accessori con un panno morbido imbevuto di acqua tiepida e detergente delicato.	Mettere gli accessori nel forno.

5.2 Prima connessione

Il display mostra un messaggio di benvenuto dopo la prima connessione.

È necessario impostare: Lingua, Luminosità, Volume toni, Volume acustico, Imposta ora.

6. UTILIZZO QUOTIDIANO



AVVERTENZA!

Fare riferimento ai capitoli sulla sicurezza.

6.1 Come impostare la funzione: Grill + Microonde, Grill.

Il forno può emettere dei rumori quando si usa la funzione: Grill + Microonde. Non si tratta di anomalie di funzionamento, considerando la funzione in corso.

UTILIZZO QUOTIDIANO

Impostazione della funzione: Grill + Microonde	
Pas-saggio 1	Inserire la griglia bassa per il grill.
Pas-saggio 2	Accendere il forno. Il display mostra la funzione cottura predefinita.
Pas-saggio 3	Premere il simbolo della funzione cottura per accedere al sottomenu.
Pas-saggio 4	Selezionare la funzione:  , Premere: OK.
Pas-saggio 5	Selezionare il livello di intensità del grill.
Funzione	Livello di intensità grill
Lo	Basso
Hi	Alto
Pas-saggio 6	Premere: OK.
Pas-saggio 7	Premere: START.
STOP - premere per spegnere il forno.	
Pas-saggio 8	Spegnere il forno.

La potenza del microonde è limitata a 500 W quando si utilizza la funzione: Grill + Microonde.

Impostazione della funzione: Grill	
Pas-saggio 1	Inserire la griglia alta.
Pas-saggio 2	Accendere il forno. Il display mostra la funzione cottura predefinita.
Pas-saggio 3	Premere il simbolo della funzione cottura per accedere al sottomenu.
Pas-saggio 4	Selezionare la funzione:  , Premere: OK.
Pas-saggio 5	Selezionare il livello di intensità del grill.
Funzione	Livello di intensità grill
Lo	Basso
Hi	Alto
Pas-saggio 6	Premere: OK.
Pas-saggio 7	Premere: START.
STOP - premere per disattivare la funzione.	
Pas-saggio 8	Spegnere il forno.

6.2 Come impostare: Funzioni cottura microonde

Passaggio 1	Accendere il forno.
Passaggio 2	Premere il simbolo della funzione cottura per accedere al sottomenu.
Passaggio 3	Selezionare la funzione di cottura a microonde e premere: OK . Il display mostra: potenza microonde.
Passaggio 4	Impostare: potenza microonde. Premere: OK .
Passaggio 5	Premere: START .
STOP - premere per disattivare la funzione.	
Passaggio 6	Spegnere il forno.

Il tempo massimo delle funzioni microonde dipende dalla potenza impostata del microonde:

POTENZA MICROONDE	TEMPO MASSIMO
100-600 W	59 minuti
Più di 600 W	7 minuti

 Se si apre la porta, la funzione si interrompe. Per riavviare, premere **START**.

Prendi una scorciatoia!





6.3 Istruzioni d'uso: Avvio rapido del microonde

Passaggio 1	Premere e tenere premuto:  . Il microonde funziona per 30 secondi.
--------------------	---



Passaggio 2	Per estendere il tempo di cottura:	
	Premere sul valore tempo in esecuzione per accedere alle impostazioni del tempo. Impostare la durata di cottura.	Premere +30 s.
Il microonde può essere acceso in qualsiasi momento con: Avvio rapido del microonde.		

6.4 Funzioni cottura



STANDARD

Funzione cottura	Applicazione
 Grill	Per grigliare alimenti di ridotto spessore e tostare il pane.
 Grill + Microonde	Per cuocere gli alimenti in un tempo breve e rosolarli. È possibile impostare 2 livelli di intensità del grill: bassa e alta.
 Microonde	Riscaldamento, cottura, gamma di potenza: 100 - 1.000 W

MICROONDE

Funzione cottura	Applicazione
 Scongelamento	Scongelamento di carne, pesce, torte, gamma di potenza: 100 - 200 W
 Scioglimento	Fusione di cioccolato e burro, gamma di potenza: 100 - 400 W
 Riscaldare	Riscaldamento di pasti pronti e alimenti delicati, gamma di potenza: 300 - 700 W

FUNZIONI DEL TIMER

Funzione cottura	Applicazione
 Funzione popcorn	Preparazione di popcorn, gamma di potenza: 700 - 1.000 W
 Liquido	Riscaldamento di bevande e zuppe, gamma di potenza: 800 - 1.000 W

7. FUNZIONI DEL TIMER

7.1 Descrizione funzioni orologio

Funzione Orologio	Applicazione
Tempo di cottura	Per impostare la durata della cottura. Il massimo è 23 ore 59 min.
Operazione finale	Per impostare cosa succede quando il timer interrompe il conteggio.
Prolunga il tempo	Per prolungare il tempo di cottura.
Promemoria	Per l'impostazione di un conto alla rovescia. Il massimo è 23 ore 59 min. Questa funzione non ha nessun effetto sul funzionamento del forno.
Timer	Monitora da quanto tempo è attiva la funzione. Timer - si può attivarla e disattivarla.

7.2 Come impostare: Funzioni Orologio

Come impostare l'orologio	
Pas-saggio 1	Premere: Imposta ora.
Pas-saggio 2	Impostare l'ora. Premere: OK.

Come impostare il tempo di cottura	
Pas-saggio 1	Scegliere la funzione cottura.
Pas-saggio 2	Premere:  .
Pas-saggio 3	Impostare l'ora. Premere: OK .

Come scegliere l'opzione di fine	
Pas-saggio 1	Scegliere la funzione cottura.
Pas-saggio 2	Premere:  .
Pas-saggio 3	Impostare la durata della cottura.
Pas-saggio 4	Premere: ● ● ● .
Pas-saggio 5	Premere: Operazione finale.
Pas-saggio 6	Scegliere il preferito: Operazione finale.
Pas-saggio 7	Premere: OK . Ripetere l'azione fino a quando il display non visualizza la schermata principale.

COME USARE: ACCESSORI

Come aumentare il tempo di cottura

Quando rimane il 10% del tempo di cottura e gli alimenti sembrano non essere cotti sarà possibile aumentare il tempo di cottura. Sarà inoltre possibile modificare la funzione cottura.

Premere **+1min** per aumentare il tempo di cottura.

Come modificare le impostazioni timer

**Pas-
saggio
1**

Premere: .

**Pas-
saggio
2**

Impostare il valore del timer.

**Pas-
saggio
3**

Premere: **OK**.

Sarà possibile impostare il tempo modificato in fase di cottura, in qualsiasi momento.

8. COME USARE: ACCESSORI

8.1 Inserimento di accessori

Usare unicamente pentole e padelle e materiale adeguato. Si rimanda al capitolo “Consigli e Suggestimenti”, stoviglie e materiali adatti per essere usati nel microonde.

Kit turntable:

Cucinare sempre il cibo sul kit per il piatto girevole.

Posizionare la guida a rulli attorno all'albero del piatto girevole. Posizionare il piatto girevole in vetro sulla guida con rulli.

Utilizzare esclusivamente il piatto girevole fornito in dotazione col forno.

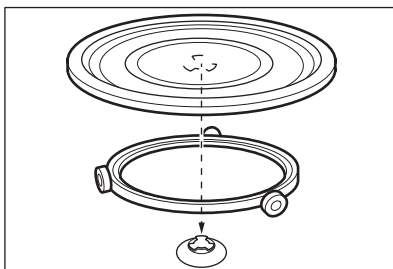

Set griglia per il grill:

Collocare la griglia per il grill con i tappi in silicone rivolti verso il basso sul kit piatto girevole.

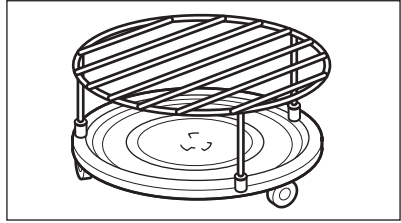

9. FUNZIONI AGGIUNTIVE

9.1 Come salvare: Preferiti

È possibile salvare le impostazioni preferite, come la funzione cottura, il tempo di cottura o la funzione di pulizia. È possibile salvare 3 impostazioni preferite.



Pas-saggio 1	Accendere il forno.
Pas-saggio 2	Selezionare l'impostazione preferita.
Pas-saggio 3	Premere: . Selezionare: Preferiti.
Pas-saggio 4	Selezionare: Salva impostazioni correnti.
Pas-saggio 5	Premere + per aggiungere l'impostazione all'elenco di: Preferiti. Premere OK.
<p> - premere per ripristinare l'impostazione.</p> <p> - premere per annullare l'impostazione.</p>	

9.2 Blocco tasti

Questa funzione evita che si cambi per sbaglio la funzione cottura.

Pas-saggio 1	Accendere il forno.
---------------------	---------------------

CONSIGLI E SUGGERIMENTI UTILI

Pas-saggio 2	Imposta una funzione di cottura.
Pas-saggio 3	  - premere contemporaneamente per attivare la funzione.
Per disattivare la funzione, ripetere il passaggio 3.	

9.3 Ventola di raffreddamento

Quando il forno è in funzione, la ventola di raffreddamento si accende in modo automatico per tenere fresche le superfici del forno. Dopo aver spento il forno, la ventola di raffreddamento potrebbe continuare a funzionare fino a che il forno non si è raffreddato.

10. CONSIGLI E SUGGERIMENTI UTILI

10.1 Consigli di cottura

<p>La temperatura e i tempi di cottura specificati nelle tabella sono valori indicativi. Dipendono dalle ricette, dalla qualità e quantità degli ingredienti utilizzati.</p> <p>Il forno può cuocere in modo differente rispetto al forno posseduto in precedenza. I suggerimenti seguenti riportano le funzioni cottura e le impostazioni consigliate per il tempo di cottura per tipi di alimenti specifici.</p> <p>Qualora non si trovino le impostazioni per una ricetta speciale, cercarne una simile.</p> <p>Per ulteriori informazioni sulla cottura rimandiamo alle tabelle di cottura sul nostro sito web. Per trovare i Suggerimenti di Cottura, controllare il codice di identificazione PNC sulla targhetta dei dati sul telaio anteriore della cavità del forno.</p>

10.2 Consigli per l'uso del microonde

Cuciniamo!

Non collocare gli alimenti direttamente sul piatto girevole. Utilizzare sempre pentole per microonde.

Posizionare la pentola al centro del piatto girevole.

Il contatto con oggetti troppo caldi o troppo freddi può rompere il piatto girevole.

Mescolare il cibo a metà cottura o a metà scongelamento/tempo di cottura.

Mescolare di tanto in tanto i piatti liquidi.

Mescolare gli alimenti prima di servirli.

Coprire gli alimenti da cucinare e riscaldare.

Mettere il cucchiaino nella bottiglia o nel bicchiere quando si riscaldano le bevande al fine di garantire una migliore distribuzione del calore.

Mettere gli alimenti in forno senza imballaggio. I pasti pronti confezionati possono essere messi nel forno solo se la loro confezione è idonea a questo scopo (controllare le informazioni sulla confezione).



Cottura al microonde

Cucinare il cibo coperto. Cuocere senza coperchio solo se si vuole che si formi una crosta.

Non cuocere eccessivamente i piatti impostando la potenza e il tempo troppo elevati. Gli alimenti si possono seccare, bruciare o prendere fuoco.

Non usare il forno per cuocere le uova o le lumache con il guscio, poiché potrebbero esplodere.

Forare il tuorlo di un uovo fritto prima di riscaldarlo.

Forare diverse volte gli alimenti con la pelle o la buccia prima della cottura.

Tagliare le verdure in pezzi di dimensioni simili.

Dopo aver spento il forno, estrarre gli alimenti e lasciarli riposare per alcuni minuti per consentire una distribuzione uniforme del calore.



Scongelamento nel microonde

Sistemare gli alimenti congelati e senza involucro su un piccolo piatto capovolto posto sopra un contenitore o una griglia di scongelamento o un colino in plastica, cosicché possa fuoriuscire il liquido di scongelamento.





Successivamente estrarre le parti scongelate.

Si può usare una potenza del microonde maggiore per cuocere frutta e verdura senza doverle scongelare prima.





10.3 Pentole e materiali adatti per un uso in microonde

Per il microonde usare solo tegami e materiali adeguati. Usare la seguente tabella come riferimento.

Controllare le specifiche delle pentole/del materiale prima dell'uso.

Pentole / Materiale				
Vetro e porcellana termoresistente (senza componenti metallici, ad es. vetro a prova di calore)	✓	✓	✓	✓
Vetro e porcellana non resistente al fuoco senza applicazioni o decorazioni in argento, oro, platino o metallo	✓	x	x	x
Vetro e vetroceramica in materiale resistente al fuoco / al gelo	✓	✓	✓	✓

CONSIGLI E SUGGERIMENTI UTILI

Pentole / Materiale				
Articoli in ceramica e terracotta, senza componenti al quarzo o componenti metalliche e smalti che contengono metallo	✓	✓	X	X
Ceramica, porcellana e oggetti di terracotta con parte inferiore non in vetro o con fori piccoli, ad esempio sulle maniglie	X	X	X	X
Plastica termoresistente fino a 200 °C	✓	✓	X	X
Cartoncino, carta	✓	X	X	X
Pellicola	✓	X	X	X
Sacchetti di cottura con chiusura adatta alle microonde	✓	✓	X	X
Piatti per arrosto in metallo, ad es. smalto, ghisa	X	X	✓	X
Teglie laccate in nero o rivestite in silicone	X	X	✓	X
Pentole che possono essere usate in microonde, ad esempio piatto crisp	X	✓	X	X
Set griglia per il grill	X	X	✓	✓

10.4 Impostazioni di potenza consigliate per diverse tipologie di cibo

I dati riportati nella tabella sono puramente indicativi.

CONSIGLI E SUGGERIMENTI UTILI

800 - 1.000 W



Rosolatura all'inizio del processo di cottura



Riscaldamento di liquidi

500 - 700 W



Cottura delle verdure



Cottura di piatti con uova



Sobbollimento stufato



Sobbollimento di riso



Riscaldamento di piatti unici



Scongela-mento e ri-scaldamen-to di alimenti congelati

300 - 400 W



Sciogliere formaggio, cioccolato, burro



Cottura /Riscaldamento di ali-menti delicati



Cottura continua

100 - 200 W



Riscaldamento di alimenti per neo-nati



Scongela-mento di pane



Scongela-mento di frutta e torte



Scongela-mento di formag-gio, panna, burro







Scongela-mento di carne, pesce

10.5 Tabelle di cottura per gli istituti di test

Informazioni per gli istituti di test

Test in conformità alla norma IEC 60705.

PULIZIA E CURA

FUNZIONE MI-CROONDE	 (W)	 (kg)		 (min)	
Pan di Spagna	600	0.475	Kit turntable	5 - 7	-
Polpettone	500	0.9	Kit turntable	18 - 20	-
Crema pasticcera cotta	500	1	Kit turntable	15 - 17	-
Scongelo carne	200	0.5	Kit turntable	8 - 9	-

**Utilizzare la funzione: Grill microonde.
Usare la griglia per il grill inferiore.**

FUNZIONE COMBO MI-CROONDE	 (W)	 Livello di intensità grill	 (min)	
Patate gratinate, 1,1 kg	300	basso	30 - 35	-
Pollo, 1,1 kg	300	alto	30 - 35	Mettere la carne nel contenitore rotondo in vetro.

11. PULIZIA E CURA





AVVERTENZA!

Fare riferimento ai capitoli sulla sicurezza.

11.1 Note sulla pulizia

 Agenti di pulizia	Pulire la parte anteriore del forno con un panno morbido imbevuto di acqua tiepida e detergente delicato.
	Servirsi di una soluzione detergente per pulire le superfici metalliche.
	Pulire le macchie con un detergente delicato.

 <p>Uso quotidiano</p>	<p>Pulire la cavità dopo ogni utilizzo. L'accumulo di grasso o di altri residui potrebbe causare un incendio. Pulire attentamente la parte superiore del forno rimuovendo i residui di cibo e grasso.</p>
 <p>Accessori</p>	<p>Pulire tutti gli accessori dopo ogni uso e lasciarli asciugare. Prima della pulizia, attendere che il piatto girevole sia freddo. Vi è il rischio che il piatto girevole si rompa. Utilizzare un panno morbido imbevuto di acqua tiepida e un detergente delicato. Non pulire gli accessori in lavastoviglie.</p> <p>Non pulire gli accessori anti-aderenti con agenti abrasivi o oggetti appuntiti.</p>



12. RISOLUZIONE DEI PROBLEMI





AVVERTENZA!

Fare riferimento ai capitoli sulla sicurezza.

12.1 Cosa fare se...



 Il forno non si accende o non riscalda	
 Causa possibile	 Soluzione
<p>Il forno non è collegato a una fonte di alimentazione elettrica o non è collegato correttamente.</p>	<p>Accertarsi che il forno sia collegato correttamente alla rete elettrica.</p>
<p>L'orologio non è impostato.</p>	<p>Impostare l'orologio; per i dettagli rimandiamo al capitolo "Funzioni dell'orologio", Come impostare: Funzioni Orologio.</p>
<p>La porta non è chiusa correttamente.</p>	<p>Chiudere completamente lo sportello.</p>
<p>È saltato il fusibile.</p>	<p>Assicurarsi che il fusibile sia la causa del problema. Qualora il problema si ripresenti, contattare un elettricista qualificato.</p>
<p>La Sicurezza bambini è attiva.</p>	<p>Rimandiamo al capitolo "Menu", Sottomenu per: Opzioni.</p>

RISOLUZIONE DEI PROBLEMI

 Componenti	
 Descrizione	 Soluzione
La lampadina è bruciata.	Sostituire la lampadina, per ulteriori dettagli rimandiamo al capitolo "Pulizia e cura". Come effettuare la sostituzione: Lampadina.
Il kit piatto girevole fa rumore.	Sotto il kit piatto girevole ci sono residui di cibo.

12.2 Come gestire: Codici di errore

Quando si verifica un errore software, il display mostra un messaggio di errore. In questa sezione verrà presentato un elenco dei problemi che è possibile gestire autonomamente.

 Codice e descrizione	 Soluzione
F240, F439 - i campi touch sul display non funzionano correttamente.	Pulire la superficie del display. Verificare che non ci sia sporizia sui campi touch.
F908 - il sistema del forno non si può collegare al pannello di controllo.	Spegnere e accendere il forno.

12.3 Dati dell'Assistenza

Qualora non sia possibile trovare una soluzione al problema, contattare il rivenditore o un Centro di assistenza autorizzato.

Le informazioni necessarie per il Centro Assistenza si trovano sulla targhetta dei dati. La targhetta si trova sul telaio anteriore della cavità del forno. Non rimuovere la targhetta dei dati dalla cavità del forno.

Consigliamo di annotare i dati qui:	
Modello (Mod.)
Codice prodotto (PNC)
Numero di serie (S.N.)

13. EFFICIENZA ENERGETICA

13.1 Risparmio energetico



Il forno è dotato di funzioni che contribuiscono al risparmio energetico durante le operazioni di cottura di tutti i giorni.

Verificare che la porta del forno sia chiusa quando lo stesso è in funzione. Non aprire la porta del forno con eccessiva frequenza in fase di cottura. Tenere pulita la guarnizione della porta e assicurarsi che sia ben fissata nella posizione corretta.

Ove possibile, non pre-riscaldare il forno prima della cottura.

Ridurre quanto più possibile gli intervalli fra le diverse operazioni di cottura quando vengono preparati più piatti contemporaneamente.

Cottura con lampada spenta

Spegnere la lampada in fase di cottura. Accenderla solo quando è necessario.

14. STRUTTURA DEL MENU

14.1 Menu

Premere  per aprire Menu.

Voce menu		Applicazione
Preferiti		Elenca le impostazioni preferite.
Opzioni		Per impostare la configurazione del forno.
Impostazioni	Configurazione	Per impostare la configurazione del forno.
	Assistenza tecnica	Mostra la versione del software e la configurazione.

14.2 Sottomenu per: Opzioni

Sottomenu	Applicazione
Luce forno	Accensione e spegnimento della lampada.

STRUTTURA DEL MENU

Sottomenu	Applicazione
Sicurezza bambini	Previene l'attivazione accidentale del forno. Quando l'opzione è attiva, il testo "Sicurezza bambini" compare sul display quando si accende il forno. Per abilitare l'uso del forno, scegliere le lettere del codice in ordine alfabetico. L'accesso al timer, all'operazione da remoto e alla lampadina è disponibile con la Sicurezza bambini attiva.
Visualizza ora	Accende e spegne l'orologio.
Visualizzazione orario digitale	Cambia il formato dell'indicazione oraria visualizzata.

14.3 Sottomenu per: Configurazione

Sottomenu	Descrizione
Lingua	Imposta la lingua del forno.
Luminosità	Imposta la luminosità del display.
Volume toni	Attiva e disattiva il tono dei tasti a sfioramento. Non è possibile disattivare i segnali acustici per: ①.
Volume acustico	Imposta il volume delle tonalità e dei segnali dei tasti.
Imposta ora	Imposta l'ora e la data attuali.

14.4 Sottomenu per: Assistenza tecnica

Sottomenu	Descrizione
Modalità demo	Codice di attivazione/disattivazione: 2468
Versione software	Informazioni sulla versione software.
Ripristino impostazioni iniziali di fabbrica	Ripristina le impostazioni di fabbrica.

15. È SEMPLICE!

Prima di iniziare a usare il dispositivo sarà necessario impostare:









Lingua	Luminosità	Volume toni	Volume acustico	Imposta ora
--------	------------	-------------	-----------------	-------------

Acquisire familiarità con le icone di base sul pannello di controllo e sul display:



 Sì / No	 Menu	 Preferiti	 Timer	START / STOP
--	---	--	--	--------------

Iniziare a usare il forno

Avvio rapido MW	Attivare funzione microonde in qualsiasi momento con le impostazioni predefinite: 30 sec/1000 W.	Premere:  .
------------------------	--	--



			
riscaldamento / cottura 100 - 1.000 W	cottura / rosolatura intensità: bassa / alta	cottura / rosolatura	riscaldamento di liquidi 800 - 1.000 W
			
riscaldare 300 - 700 W	scongelo 100 - 200 W	scioglimento 100 - 400 W	preparazione di popcorn 700 - 1.000 W

Impostazioni del forno a microonde		Suggerimenti per il microonde
Potenza microonde:	Tempo massimo:	Coprire gli alimenti da cucinare e riscaldare. Mescolare il cibo a metà cottura o a metà scongelamento/tempo di cottura. Collocare il cucchiaino nel piatto durante il riscaldamento di liquidi. Mettere gli alimenti in forno senza imballaggio (solo adatto a microonde).
100-600 W	59 min.	
> 600 W	7 min.	

Avviare la cottura				
Passaggio 1	Passaggio 2	Passaggio 3	Passaggio 4	Passaggio 5
 - premere per accendere il forno.	 ... - selezionare la funzione.	W - impostare la potenza del microonde.	OK - premere per confermare.	START - premere per avviare il processo di cottura.

Usare le funzioni rapide per impostare il tempo di cottura necessario	
Funzione Finish Assist 10% Usare la Funzione Finish Assist 10% per aggiungere ulteriore tempo quando rimane il 10% del tempo di cottura.	Per allungare il tempo di cottura, premere +1min.

16. CONSIDERAZIONI SULL'AMBIENTE

Riciclare i materiali con il simbolo . Buttare l'imballaggio negli appositi contenitori per il riciclaggio. Aiutare a proteggere l'ambiente e la salute umana e a riciclare rifiuti derivanti da apparecchiature elettriche ed elettroniche. Non smaltire le apparecchiature che riportano il simbolo  insieme ai normali rifiuti domestici. Portare il prodotto al punto di riciclaggio più vicino o contattare il comune di residenza.

VOOR PERFECTE RESULTATEN

Bedankt dat je voor dit AEG-product hebt gekozen. We hebben het gecreëerd om jarenlang onberispelijke prestaties te leveren, met innovatieve technologieën die het leven eenvoudiger maken – functies die je wellicht niet op gewone apparaten aantreft. Neem een paar minuten de tijd om het beste uit het apparaat te halen.

Ga naar onze website voor:



Advies over gebruik, brochures, het oplossen van problemen, service- en reparatie-informatie:

www.aeg.com/support



Registreer je product voor een betere service:

www.registeraeg.com



Koop accessoires, verbruiksartikelen en originele reserveonderdelen voor je apparaat:

www.aeg.com/shop

KLANTENSERVICE EN SERVICE

Gebruik altijd originele onderdelen.

Als u contact opneemt met onze erkende servicedienst, zorg er dan voor dat u de volgende gegevens tot uw beschikking hebt: Model, PNC, serienummer.

De informatie vindt u op het typeplaatje.

 Waarschuwingen en veiligheidsinformatie

 Algemene informatie en tips

 Milieu-informatie

Wijzigingen voorbehouden.

INHOUDSOPGAVE

1. VEILIGHEIDSINFORMATIE.....	242	3.2 Accessoires.....	250
1.1 De veiligheid van kinderen en kwetsbare personen.....	242	4. HET IN- EN UITSCHAKELEN VAN DE OVEN.....	250
1.2 Algemene veiligheid.....	243	4.1 Bedieningspaneel.....	250
2. VEILIGHEIDSVOORSCHRIFTEN.....	246	4.2 Display.....	251
2.1 Installeren.....	246	5. VOORAFGAAND AAN HET EERSTE GEBRUIK.....	252
2.2 Elektrische aansluiting.....	247	5.1 Eerste reiniging	252
2.3 Gebruik.....	247	5.2 Eerste verbinding.....	252
2.4 Onderhoud en reiniging.....	248	6. DAGELIJKS GEBRUIK.....	253
2.5 Binnenverlichting.....	248	6.1 De functie instellen: Grill + magnetron, Grillen.....	253
2.6 Service.....	249		
2.7 Verwijdering.....	249		
3. BESCHRIJVING VAN HET PRODUCT... 249			
3.1 Algemeen overzicht.....	249		

6.2 Instellen: Magnetronverwarmingsfuncties.....	254	10.4 Aanbevolen vermogensinstellingen voor verschillende soorten voedsel...	262
6.3 Ga als volgt te werk voor gebruik: Magnetron snel starten.....	255	10.5 Kooktafels voor testinstituten.....	263
6.4 Verwarmingsfuncties.....	255	11. ONDERHOUD EN REINIGING.....	264
7. KLOKFUNCTIES.....	256	11.1 Opmerkingen over schoonmaken.....	264
7.1 Omschrijving klokfuncties.....	256	12. PROBLEEMOPLOSSING.....	265
7.2 Instellen: Klokfuncties.....	257	12.1 Wat te doen als.....	265
8. GA ALS VOLGT TE WERK VOOR GEBRUIK: ACCESSOIRES.....	258	12.2 Hoe te beheren: Foutcodes.....	265
8.1 Accessoires plaatsen.....	258	12.3 Servicegegevens.....	266
9. EXTRA FUNCTIES.....	259	13. ENERGIEZUINIGHEID.....	266
9.1 Hoe kan ik opslaan: Favorieten...	259	13.1 Energiebesparing.....	266
9.2 Toetsenblokkering.....	259	14. MENUSTRUCTUUR.....	266
9.3 Koelventilator.....	259	14.1 Menu.....	266
10. AANWIJZINGEN EN TIPS.....	260	14.2 Submenu voor: Opties.....	267
10.1 Kookadviezen.....	260	14.3 Submenu voor: Instelling.....	267
10.2 Magnetronaanbevelingen	260	14.4 Submenu voor: Service.....	268
10.3 Kookgerei en materialen geschikt voor de magnetron	261	15. HET IS HEEL GEMAKKELIJK!.....	268
		16. MILIEUBESCHERMING.....	269

1. VEILIGHEIDSINFORMATIE

Lees zorgvuldig de meegeleverde instructies voor installatie en gebruik van het apparaat. De fabrikant is niet verantwoordelijk voor verwondingen of schade die voortvloeit uit de onjuiste installatie of het onjuiste gebruik. Bewaar de instructies altijd op een veilige, toegankelijke plek voor toekomstig gebruik.

1.1 De veiligheid van kinderen en kwetsbare personen

- Dit apparaat kan worden gebruikt door kinderen van 8 jaar en ouder en door mensen met een beperkt lichamelijk, zintuiglijk of verstandelijk vermogen of een gebrek aan ervaring en kennis, indien zij onder toezicht staan of instructies hebben gekregen over het veilig gebruiken van het apparaat en indien zij de gevaren begrijpen. Kinderen jonger dan 8 jaar en personen met zware en complexe beperkingen dienen altijd uit de buurt van het apparaat te

worden gehouden, tenzij ze voortdurend onder toezicht staan.

- Houd toezicht op kinderen om te voorkomen dat zij met het apparaat gaan spelen..
- Houd alle verpakking uit de buurt van kinderen en gooi het op passende wijze weg.
- **WAARSCHUWING:** Houd kinderen en huisdieren uit de buurt van het apparaat als die in werking is of afkoelt. Makkelijk toegankelijke onderdelen worden heet tijdens het gebruik.
- Als het apparaat is voorzien van een kinderslot, dient dit te worden geactiveerd.
- Kinderen mogen zonder toezicht geen reinigings- en onderhoudswerkzaamheden aan het apparaat uitvoeren.

1.2 Algemene veiligheid

- Dit apparaat is uitsluitend bestemd om mee te koken.
- Dit apparaat is bedoeld voor huishoudelijk gebruik in een binnenomgeving.
- Dit apparaat kan worden gebruikt in kantoren, hotelkamers, bed & breakfast-kamers, boerderijgastenhuisen en andere soortgelijke accommodaties waar dergelijk gebruik niet hoger is dan (gemiddeld) huishoudelijk gebruik.
- Alleen een erkende installatietechnicus mag dit apparaat installeren en de kabel vervangen.
- Gebruik het apparaat niet voordat u het in de ingebouwde constructie installeert.
- Trek de stekker van het apparaat uit het stopcontact voordat u welke soort onderhoud dan ook gaat uitvoeren.
- Als het netsnoer beschadigd is, moet de fabrikant, een erkend servicecentrum of een gekwalificeerde persoon deze vervangen teneinde gevaarlijke situaties met elektriciteit te voorkomen.

- **WAARSCHUWING:** Zorg ervoor dat het apparaat is uitgeschakeld voordat u de lamp vervangt om elektrische schokken te voorkomen.
- **WAARSCHUWING:** Het apparaat en de toegankelijke onderdelen ervan worden heet tijdens het gebruik. U dient te voorkomen de verwarmingselementen aan te raken.
- Gebruik altijd ovenhandschoenen om accessoires of ovenschalen te verwijderen of erin te plaatsen.
- Gebruik alleen de draaitafel en de draaitafelsteun die voor dit apparaat zijn ontworpen.
- Activeer de magnetronfunctie niet wanneer het apparaat leeg is. Metalen onderdelen in de ruimte kunnen elektrische vonken veroorzaken.
- Tijdens bereiding in de magnetron zijn geen metalen voedselbakjes en drinkbekers toegestaan. Deze vereiste is niet van toepassing als de fabrikant heeft aangegeven dat het formaat en de vorm van het metalen voorwerp geschikt is voor bereiding in de magnetron.
- **WAARSCHUWING:** Als de deur of deurafdichtingen beschadigd zijn, mag het apparaat niet worden gebruikt totdat het is gerepareerd door een erkende installatietechnicus.
- **WAARSCHUWING:** Alleen een erkende installatietechnicus kan service- of reparatiewerkzaamheden uitvoeren waarbij een afdekking wordt verwijderd die bescherming biedt tegen blootstelling aan magnetronenergie.
- **WAARSCHUWING:** Warm geen vloeistoffen en ander voedsel in afgesloten verpakkingen op. Ze kunnen exploderen.
- Gebruik alleen voorwerpen die geschikt zijn voor gebruik in de magnetron.
- Let bij het opwarmen van voedsel in plastic of papieren verpakkingen op het apparaat vanwege de mogelijkheid tot zelfontbranding.

- Het apparaat is bedoeld voor het opwarmen van voedsel en dranken. Het drogen van voedsel of kleding en het opwarmen van warmhoudkussentjes, slippers, sponzen, vochtige doeken enzovoort kunnen leiden tot letsel, vonkontsteking of brand.
- Als rook wordt uitgestoten, schakelt u het apparaat uit of trekt u de stekker uit het stopcontact en houdt u de deur gesloten om vlammen te kunnen doven.
- Het opwarmen van dranken in de magnetron kan tot kookvertraging leiden. Wees voorzichtig bij het hanteren van de verpakking.
- De inhoud van zuigflesjes en babyvoedingspotjes moet worden geroerd of geschud en de temperatuur vóór het gebruik worden gecontroleerd om brandwonden te voorkomen.
- Eieren in hun schaal en hele hardgekookte eieren mogen niet in het apparaat worden opgewarmd omdat ze kunnen exploderen, zelfs nadat de opwarming in de magnetron is beëindigd.
- Het apparaat moet regelmatig worden gereinigd en alle voedselresten moeten worden verwijderd.
- Gebruik geen stoomreiniger om het apparaat schoon te maken.
- Gebruik nooit agressieve reinigingsmiddelen of scherpe metalen schrapers om de glazen deur schoon te maken. Deze kunnen krassen veroorzaken op het oppervlak, waardoor het glas zou kunnen breken.
- Als het apparaat niet in een schone toestand wordt onderhouden, kan dit leiden tot een verslechtering van het oppervlak. Dit kan de levensduur van het apparaat negatief beïnvloeden en mogelijk een gevaarlijke situatie opleveren.

2. VEILIGHEIDSVOORSCHRIFTEN

2.1 Installeren

**WAARSCHUWING!**

Alleen een erkende installatietechnicus mag het apparaat installeren.

- Verwijder alle verpakkingsmaterialen.
- Installeer en gebruik geen beschadigd apparaat.
- Volg de installatie-instructies die zijn meegeleverd met het apparaat.
- Pas altijd op bij verplaatsing van het apparaat, want het is zwaar. Gebruik altijd veiligheidshandschoenen en gesloten schoeisel.
- Trek het apparaat nooit aan de handgreep van zijn plaats.
- Installeer het apparaat op een veilige en geschikte plaats die aan alle installatie-eisen voldoet.
- Houd de minimumafstand naar andere apparaten en units in acht.
- Controleer, voordat u het apparaat monteert, of de ovendeur onbelemmerd opengaat.
- Het apparaat is uitgerust met een elektrisch koelsysteem. Het moet worden gebruikt met de elektrische voeding.
- De inbouweenheid moet voldoen aan de stabiliteitsvereisten van DIN 68930.

Minimumhoogte kast (Minimumhoogte kast onder werkblad)	444 (460) mm
Kastbreedte	560 mm
Kastdiepte	550 (550) mm
Hoogte van de voorkant van het apparaat	455 mm
Hoogte van de achterkant van het apparaat	440 mm
Breedte van de voorkant van het apparaat	595 mm
Breedte van de achterkant van het apparaat	559 mm
Diepte van het apparaat	567 mm
Ingebouwde diepte van het apparaat	546 mm
Diepte met open deur	882 mm
Minimumgrootte ventilatieopening. Opening geplaatst aan de onderkant van de achterzijde	560x20 mm
Lengte netvoedingskabel. Kabel wordt in de rechterhoek van de achterzijde geplaatst	1500 mm

Bevestigingsschroeven	3.5x25 mm
-----------------------	-----------

2.2 Elektrische aansluiting



WAARSCHUWING!

Gevaar voor brand en elektrische schokken.

- Alle elektrische aansluitingen moeten door een gediplomeerd elektromonteur worden gemaakt.
- Dit apparaat moet worden aangesloten op een geaard stopcontact.
- Zorg ervoor dat de parameters op het vermogensplaatje overeenkomen met elektrische vermogen van de netstroom.
- Gebruik altijd een juist geïnstalleerd schokbestendig stopcontact.
- Gebruik geen adapters met meerdere stekkers en verlengkabels.
- Zorg dat u de netstekker en het netsnoer niet beschadigt. Indien de voedingskabel moet worden vervangen, dan moet dit gebeuren door onze Klantenservice.
- Laat de stroomkabel niet in aanraking komen met de deur van het apparaat of de niche onder het apparaat, met name niet als deze werkt of als de deur heet is.
- De schokbescherming van delen onder stroom en geïsoleerde delen moet op zo'n manier worden bevestigd dat het niet zonder gereedschap kan worden verplaatst.
- Steek de stekker pas in het stopcontact als de installatie is voltooid. Zorg ervoor dat het netsnoer na installatie bereikbaar is.
- Als het stopcontact los zit, mag u de stekker niet in het stopcontact steken.
- Trek niet aan het netsnoer om het apparaat los te koppelen. Trek altijd aan de stekker.
- Gebruik enkel correcte isolatievoorzieningen: stroomonderbrekers, zekeringen (schroefzekeringen moeten uit de houder worden verwijderd), aardlekschakelaars en contactgevers.
- De elektrische installatie moet een isolatieapparaat bevatten waardoor het apparaat volledig van het lichtnet afgesloten kan worden. Het isolatieapparaat moet een contactopening hebben met een minimale breedte van 3 mm.
- Dit apparaat wordt geleverd met een stekker en een netsnoer.

2.3 Gebruik



WAARSCHUWING!

Gevaar voor letsel, brandwonden, elektrische schokken of een explosie.

- De specificatie van dit apparaat niet wijzigen.
- Zorg ervoor dat de ventilatieopeningen niet geblokkeerd worden.
- Laat het apparaat tijdens de werking niet onbeheerd achter.
- Schakel het apparaat na elk gebruik uit.
- Wees voorzichtig met het openen van de deur van het apparaat wanneer het apparaat in werking is. Er kan hete lucht vrijkomen.
- Gebruik het apparaat niet met natte handen of als het contact maakt met water.
- Oefen geen druk uit op de open deur.
- Gebruik het apparaat niet als werkblad of als opslagoppervlak.
- Open de deur van het apparaat voorzichtig. Het gebruik van ingrediënten met alcohol kan een mengsel van alcohol en lucht veroorzaken.

VEILIGHEIDSVOORSCHRIFTEN

- Laat geen vonken of open vlammen in contact met het apparaat komen wanneer u de deur opent.
- Plaats geen ontvlambare producten of artikelen die vochtig zijn met ontvlambare producten in, bij of op het apparaat.
- Gebruik de magnetronfunctie niet om de oven voor te verwarmen.



WAARSCHUWING!

Risico op schade aan het apparaat.

- Om schade of verkleuring van het email te voorkomen:
 - leg geen aluminiumfolie op de bodem van de ruimte in het apparaat.
 - plaats geen water direct in het hete apparaat.
 - bewaar geen vochtige gerechten en voedsel in het apparaat nadat u klaar bent met koken.
 - wees voorzichtig bij het verwijderen of bevestigen van accessoires.
- Verkleuring van het email of roestvrij staal is niet van invloed op de werking van het apparaat.
- Kook altijd met de deur van het apparaat gesloten.
- Als het apparaat achter een meubelpaneel gemonteerd is (bijv. een deur), zorg er dan voor dat de deur nooit gesloten is als het apparaat in werking is. Warmte en vocht kunnen achter een gesloten meubelpaneel ophopen en schade aan het apparaat, de behuizing of de vloer veroorzaken. Sluit het meubelpaneel niet tot het apparaat compleet is afgekoeld na gebruik.

2.4 Onderhoud en reiniging



WAARSCHUWING!

Gevaar voor letsel, brand en schade aan het apparaat.

- Schakel het apparaat uit en trek de stekker uit het stopcontact voordat u onderhoudshandelingen verricht.
- Zorg ervoor dat het apparaat is afgekoeld. Er bestaat een risico dat de glasplaten kunnen breken.
- Vervang direct de glazen deurpanelen als deze beschadigd zijn. Neem contact op met een erkend servicecentrum.
- Wees voorzichtig als u de deur van het apparaat verwijdert. De deur is zwaar!
- Zorg ervoor dat de ovenruimte, de draaitafel en de deur na elk gebruik worden afgeveegd. Stoom geproduceerd tijdens de werking van het apparaat condenseert op de wanden en kan roest veroorzaken.
- Reinig het apparaat regelmatig om te voorkomen dat het materiaal van het oppervlak achteruitgaat.
- Vet en voedsel dat in het apparaat achterblijft, kan brand en elektrische vonken veroorzaken wanneer de magnetronfunctie werkt.
- Maak het apparaat schoon met een vochtige zachte doek. Gebruik alleen neutrale schoonmaakmiddelen. Gebruik geen schuurmiddelen, schuursponsjes, oplosmiddelen of metalen voorwerpen.
- Volg als u een ovenspray gebruikt de aanwijzingen op de verpakking.

2.5 Binnenverlichting



WAARSCHUWING!

Gevaar voor elektrische schokken.

BESCHRIJVING VAN HET PRODUCT

- Met betrekking tot de lamp(en) in dit product en reservelampen die afzonderlijk worden verkocht: Deze lampen zijn bedoeld om bestand te zijn tegen extreme fysieke omstandigheden in huishoudelijke apparaten, zoals temperatuur, trillingen, vochtigheid, of zijn bedoeld om informatie te geven over de operationele status van het apparaat. Ze zijn niet bedoeld voor gebruik in andere toepassingen en zijn niet geschikt voor verlichting in huishoudelijke ruimten.
- Dit product bevat een lichtbron van energie-efficiëntieklasse G.
- Gebruik alleen lampjes met dezelfde specificaties.

2.6 Service

- Neem contact op met de erkende servicedienst voor reparatie van het apparaat.
- Gebruik alleen originele reserveonderdelen.

2.7 Verwijdering



WAARSCHUWING!

Gevaar voor letsel of verstikking.

- Neem contact op met uw plaatselijke overheid voor informatie over het afvoeren van het apparaat.
- Haal de stekker uit het stopcontact.
- Snijd het netsnoer vlak bij het apparaat af en gooi het weg.
- Verwijder de deurvergrendeling om te voorkomen dat kinderen of huisdieren binnen in het apparaat vast komen te zitten.

3. BESCHRIJVING VAN HET PRODUCT

3.1 Algemeen overzicht

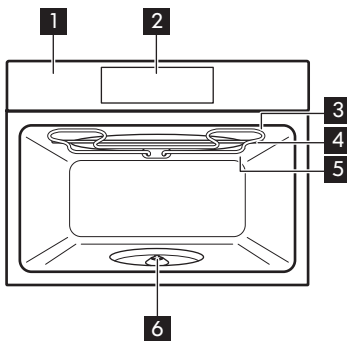

- 1 Bedieningspaneel
- 2 Display
- 3 Verwarmingselement
- 4 Magnetrongenerator
- 5 Lamp
- 6 Draaiplateau-as

HET IN- EN UITSCHAKELEN VAN DE OVEN

3.2 Accessoires

Turntableset

Om eten te bereiden.

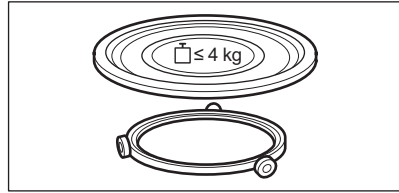

Grillrekset

Om te grillen.

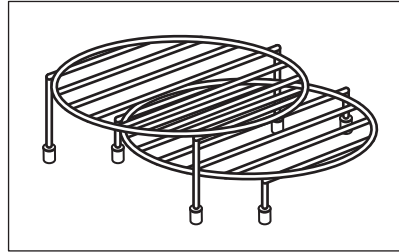

4. HET IN- EN UITSCHAKELEN VAN DE OVEN

4.1 Bedieningspaneel

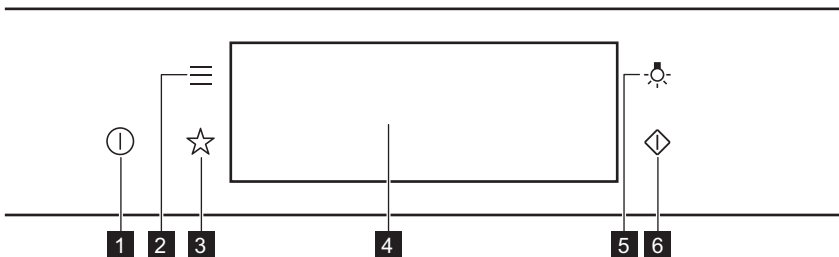



1	Aan / UIT	Houd ingedrukt om de oven in en uit te schakelen.
2	Menu	Geeft een overzicht van de ovenfuncties.
3	Favorieten	Geeft een overzicht van de favoriete instellingen.
4	Display	Toont de huidige instellingen van de oven.
5	Lampschakelaar	Om de verlichting in en uit te schakelen.

HET IN- EN UITSCHAKELLEN VAN DE OVEN

6	Magnetron snel starten	Om de magnetronfunctie in te schakelen (1000 W en 30 seconden).
----------	------------------------	---

 Druk	 Verplaatsen	 Ingedrukt houden
Raak het oppervlak aan met de vingertop.	Schuif de vingertop over het oppervlak.	Raak het oppervlak 3 seconden aan.

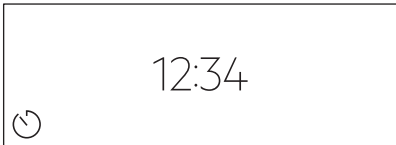







4.2 Display

	<p>Na het inschakelen wordt op de display het hoofdscherm met de functie en de standaard grillintensiteit weergegeven.</p> <p>A. Dagtijd B. BEGIN/STOP C. Grillintensiteit D. Verwarmingsfuncties E. Magnetronvermogen F. Timer</p>
	Als u de oven 2 minuten niet gebruikt, gaat de display naar stand-by.
	Wanneer u kookt, worden op de display de ingestelde functies en andere beschikbare opties weergegeven.

Indicatielampjes op de display

Basisindicatielampjes: om op de display te navigeren.

VOORAFGAAND AAN HET EERSTE GEBRUIK

 Om de selectie/instelling te bevestigen.	 Om één niveau terug te gaan in het menu.	 Om de laatste handeling ongedaan te maken.	 Om de opties in en uit te schakelen.
Geluidsalarm functie-indicatielampjes - wanneer de ingestelde kooktijd ten einde is, klinkt het signaal.			
 De functie is ingeschakeld.	 De functie is ingeschakeld. Het koken stopt automatisch.	 Het geluidsalarm staat uit.	
Indicatielampjes timer			
 De functie instellen: Uitgestelde start.		 Om de instelling te annuleren.	

5. VOORAFGAAND AAN HET EERSTE GEBRUIK



WAARSCHUWING!

Raadpleeg de hoofdstukken Veiligheid.

5.1 Eerste reiniging

		
Stap 1	Stap 2	Stap 3
Haal alle accessoires uit de oven.	Reinig de oven en de accessoires met een zachte doek, warm water en een mild reinigingsmiddel.	Plaats de accessoires in de oven.

5.2 Eerste verbinding

Het display toont een welkomstbericht na de eerste verbinding.

Je moet het volgende instellen: Taal, Helderheid display, Toetstonen, Geluidsvolume, Dagtijd.

6. DAGELIJKS GEBRUIK



WAARSCHUWING!

Raadpleeg de hoofdstukken Veiligheid.

6.1 De functie instellen: Grill + magnetron, Grillen

De oven kan geluiden maken wanneer er gebruik wordt gemaakt van de functie: Grill + magnetron. Dit is normaal voor deze functie.

De functie instellen: Grill + magnetron	
Stap 1	Plaats het lage grillrooster.
Stap 2	Zet de oven aan. Op het display verschijnt de standaard verwarmingsfunctie.
Stap 3	Druk op het symbool van de verwarmingsfunctie om het submenu te openen.
Stap 4	Selecteer de functie:  . Druk op: OK.
Stap 5	Selecteer het niveau van de grillintensiteit.
Functie	Intensiteitsniveau grill
Lo	Laag
Hi	Hoog
Stap 6	Druk op: OK.
Stap 7	Druk op: START .
STOP - druk hierop om de oven uit te schakelen.	
Stap 8	Schakel de oven uit.

Het magnetronvermogen is beperkt tot 500 W wanneer je gebruikmaakt van de functie: Grill + magnetron.

De functie instellen: Grillen	
Stap 1	Plaats het grote grillrek.
Stap 2	Zet de oven aan. Op het display verschijnt de standaard verwarmingsfunctie.

De functie instellen: Grillen	
Stap 3	Druk op het symbool van de verwarmingsfunctie om het submenu te openen.
Stap 4	Selecteer de functie:  . Druk op: OK.
Stap 5	Selecteer het niveau van de grillintensiteit.
Functie	Intensiteitsniveau grill
Lo	Laag
Hi	Hoog
Stap 6	Druk op: OK.
Stap 7	Druk op: START .
Druk op STOP om de functie uit te schakelen.	
Stap 8	Schakel de oven uit.

6.2 Instellen: Magnetronverwarmingsfuncties

Stap 1	Zet de oven aan.
Stap 2	Druk op het symbool van de verwarmingsfunctie om het submenu te openen.
Stap 3	Selecteer de magnetronverwarmingsfunctie en druk op: OK. Op het display verschijnt: magnetronvermogen.
Stap 4	Instellen: magnetronvermogen. Druk op: OK.
Stap 5	Druk op: START .
Druk op STOP om de functie uit te schakelen.	
Stap 6	Schakel de oven uit.

De maximale tijd van de magnetronfuncties is afhankelijk van het door jou ingestelde magnetronvermogen:

MAGNETRONVERMOGEN	MAXIMUMTIJD
100 - 600 W	59 minuten
Meer dan 600 W	7 minuten



Als u de deur opent, stopt de functie. Om het weer te starten, drukt u op **START**.

Doe het op een snellere manier!





6.3 Ga als volgt te werk voor gebruik: Magnetron snel starten

Stap 1	Indrukken en vasthouden:  . De magnetron draait 30 seconden.	
Stap 2	Om de bereidingstijd te verlengen:	
	Druk op de draaitijdwaarde om naar de tijdsinstellingen te gaan. Stel de bereidingstijd in.	Druk op +30 s.
De magnetron kan op elk moment worden ingeschakeld met: Magnetron snel starten.		

6.4 Verwarmingsfuncties





STANDAARD

Verwarmingsfunctie	Toepassing
 Grillen	Om dunne stukken voedsel te grillen en brood te roosteren.
 Grill + magnetron	Om gerechten korter te bereiden en tegelijkertijd een bruin korstje te geven. U kunt 2 niveaus van grillintensiteit instellen: laag en hoog.

KLOKFUNCTIES

Verwarmingsfunctie	Toepassing
 Magnetron	Opwarmen, koken, vermogensbereik: 100 - 1000 W

MAGNETRON

Verwarmingsfunctie	Toepassing
 Ontdooien	Vlees, vis, gebak ontdooien, vermogensbereik: 100 - 200 W
 Smelten	Chocolade en boter smelten, vermogensbereik: 100 - 400 W
 Opwarmen	Vermogensbereik voor het opwarmen van vooraf bereide maaltijden en delicaat voedsel: 300 - 700 W
 Popcorn	Vorbereiding popcorn, vermogensbereik: 700 - 1000 W
 Vloeistof	Opwarmen van dranken en soepen, vermogensbereik: 800 - 1000 W

7. KLOKFUNCTIES

7.1 Omschrijving klokfuncties

Klokfunctie	Toepassing
Kooktijd	De duur van het koken instellen. Maximaal 23 uur 59 min.
Actie beëindigen	Voor het instellen wat er gebeurt als de timer stopt met tellen.
Tijd verlenging	Om de kooktijd te verlengen.

Klokfunctie	Toepassing
Herinnering	Om een aftelling in te stellen. Maximum is 23 uur 59 min. Deze functie heeft geen invloed op de werking van de oven.
Uptimer	Controleert hoelang de functie werkt. Uptimer - je kunt deze in- en uitschakelen.

7.2 Instellen: Klokfuncties

De klok instellen	
Stap 1	Druk op: Dagtijd.
Stap 2	Stel de tijd in. Druk op: OK.

De bereidingstijd instellen	
Stap 1	Kies de verwarmingsfunctie.
Stap 2	Druk op:  .
Stap 3	Stel de tijd in. Druk op: OK.

De eindoptie kiezen	
Stap 1	Kies de verwarmingsfunctie.
Stap 2	Druk op:  .
Stap 3	Stel de bereidingstijd in.
Stap 4	Druk op: ● ● ● .
Stap 5	Druk op: Actie beëindigen.
Stap 6	Kies je voorkeur: Actie beëindigen.
Stap 7	Druk op: OK. Herhaal de actie totdat het hoofdscherm op het display verschijnt.

GA ALS VOLGT TE WERK VOOR GEBRUIK: ACCESSOIRES

De bereidingstijd verlengen

Wanneer 10% van de bereidingstijd overblijft en het voedsel niet klaar lijkt te zijn, kun je de bereidingstijd verlengen. Je kunt ook de verwarmingsfunctie wijzigen.

Druk op **+1min** om de kooktijd te verlengen.

De timerinstellingen wijzigen

Stap 1 Druk op: .

Stap 2 Stel de timerwaarde in.

Stap 3 Druk op: **OK**.

Je kunt de ingestelde tijd tijdens het koken op elk gewenst moment wijzigen.

8. GA ALS VOLGT TE WERK VOOR GEBRUIK: ACCESSOIRES

8.1 Accessoires plaatsen

Gebruik uitsluitend geschikt kookgerei en materiaal. Raadpleeg hoofdstuk 'Hints en tips', kookgerei en materiaal geschikt voor de magnetron.

Turntableset:

Bereid voedsel altijd op de draaiplateauset.
Plaats de rolgeleider rond de draaischijf.
Plaats het draaitafelglas op de rolgeleiding.
Gebruik alleen de draaitafelset meegeleverd met de oven.

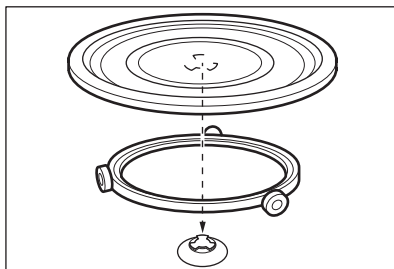

Grillrekset:

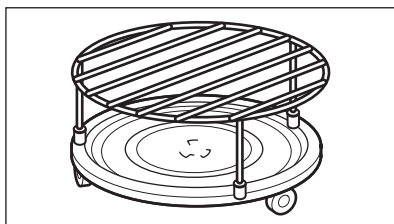

Plaats het grillrooster met de siliconen doppen op de draaiplateauset.



9. EXTRA FUNCTIES



9.1 Hoe kan ik opslaan: Favorieten

U kunt uw favoriete instellingen opslaan, zoals de verwarmingsfunctie, de bereidingstijd of de reinigingsfunctie. U kunt 3 favoriete instellingen opslaan.

Stap 1	Schakel de oven in.
Stap 2	Selecteer de gewenste instelling.
Stap 3	Druk op:  . Selecteer: Favorieten.
Stap 4	Selecteer: Huidige instellingen opslaan.
Stap 5	Druk op + om de instelling toe te voegen aan de lijst met: Favorieten. Druk op OK.
<p> - druk hierop om de instelling te resetten.</p> <p> - druk hierop om de instelling te annuleren.</p>	

9.2 Toetsenblokkering

Deze functie voorkomt dat de verwarmingsfunctie per ongeluk wordt gewijzigd.

Stap 1	Schakel de oven in.
Stap 2	Stel een verwarmingsfunctie in.
Stap 3	 ,  - druk hier tegelijkertijd op om de functie in te schakelen.
Herhaal stap 3 om de functie uit te schakelen.	

9.3 Koelventilator

Als de oven in werking is, wordt de koelventilator automatisch ingeschakeld om de oppervlakken van de oven koel te houden. Als u de oven uitschakelt, kan de koelventilator blijven werken totdat de oven is afgekoeld.

10. AANWIJZINGEN EN TIPS

10.1 Kookadviezen



De temperatuur en kooktijden in de tabellen zijn slechts als richtlijn bedoeld. Ze zijn afhankelijk van de recepten en de kwaliteit en kwantiteit van de gebruikte ingrediënten. Uw oven kan anders bakken dan de oven die u tot nu toe gebruikt heeft. De onderstaande hints tonen aanbevolen verwarmingsfuncties en instellingen voor kooktijd voor specifieke soorten voedsel. Als u voor een speciaal recept de instelling niet kunt vinden, zoek dan naar een soortgelijk recept. Voor meer kookaanbevelingen kunt u de kooktabellen op onze website raadplegen. Om de Kookhints te vinden, controleer het productnummer op het classificatieplaatje op de voorzijde van het frame van de binnenkant van de oven.

10.2 Magnetronaanbevelingen

Laten we koken!

Leg het eten niet direct op de draaiplateau. Gebruik altijd kookgerei dat geschikt is voor de magnetron.

Plaats het kookgerei in het midden van de draaiplateau.

Contact met te warme of te koude voorwerpen kan de draaiplateau breken.

Draai het voedsel halverwege de ontdooi- en bereidingstijd om of roer het door.

Roer vloeibare gerechten zo nu en dan door.

Roer het voedsel voor het opdienen door.

Dek het voedsel voor bereiding en opwarming af.

Zet tijdens het opwarmen van dranken de lepel in de fles of het glas om de warmte beter te verdelen.

Plaats het voedsel in de oven zonder verpakkingsmateriaal. De verpakte kant-en-klaarmaaltijden kunnen alleen in de oven worden geplaatst als de verpakking magnetronbestendig is (raadpleeg de informatie op de verpakking).



Koken in de magnetron

Bereid voedsel afgedekt. Bereid voedsel slechts zonder het te bedekken als je een korst wilt behouden.

Kook de gerechten niet te lang door het vermogen en de tijd te hoog instellen. Het voedsel kan uitdrogen, aanbranden of brand veroorzaken.

Gebruik de oven niet om eieren in hun schaal en slakken met huisjes te bereiden, omdat deze kunnen barsten. Prik het eigeel van gebakken eieren door voordat ze worden opgewarmd.

Prik voedsel met huid of schil diverse malen door voordat je het bereidt.

Snij groenten in stukjes van gelijke grootte.

Nadat je de oven uitzet, neem je het voedsel uit de oven en laat je het een paar minuten rusten om de warmte gelijkmatig te verdelen.



Ontdooien in de magnetron

Plaats het bevroren, uitgepakte voedsel op een klein omgekeerd bord met een bakje eronder of op een ontdooierek of plastic zeef, zodat de dooivloeistof kan weglopen.





Verwijder telkens de stukken die zijn ontdooid.

Je kunt een hoger magnetronvermogen gebruiken om fruit en groenten te bereiden zonder ze eerst te ontdooien.





10.3 Kookgerei en materialen geschikt voor de magnetron

Gebruik alleen kookgerei en materiaal in de magnetron dat hier geschikt voor is. Gebruik onderstaande tabel als referentie.

Controleer de specificaties van het kookgerei/materiaal voor gebruik.



Kookgerei/materiaal				
Ovenvast glas en porselein zonder metalen onderdelen, bijv. hittebestendig glas	✓	✓	✓	✓
Niet-ovenbestendig glas en porselein zonder zilveren, gouden, platina of andere metalen versieringen	✓	x	x	x
Glas en glaskeramik van ovenbestendig / diepvriesbestendig materiaal	✓	✓	✓	✓
Keramik en aardewerk zonder kwarts of metalen onderdelen en metaalhoudend glazuur	✓	✓	x	x
Keramik, porselein en aardewerk met ongeglazuurde onderkant of met kleine gaatjes, bijv. op handvaten	x	x	x	x
Tot 200 °C hittebestendige kunststof	✓	✓	x	x
Karton, papier	✓	x	x	x
Huishoudfolie	✓	x	x	x
Ovenfolie met magnetronveilige sluiting	✓	✓	x	x







AANWIJZINGEN EN TIPS

Kookgerei/materiaal				
Braadschalen gemaakt van metaal, bijv. email, gietijzer	X	X	✓	X
Bakblikken, zwarte lak of met siliconen coating	X	X	✓	X
Kookgerei voor gebruik in magnetron, bijv. pan voor knapperige gerechten	X	✓	X	X
Grillrekset	X	X	✓	✓





10.4 Aanbevolen vermogensinstellingen voor verschillende soorten voedsel

De gegevens in de tabel dienen alleen als richtlijn.

800 - 1000 W	
 Aanbakken aan het begin van het kookproces	 Vloeistoffen opwarmen

500 - 700 W					
 Groenten koken	 Eiergerechten bereiden	 Hutspot laten sudderen	 Rijst sudderen	 Eenpansgerechten opwarmen	 Ontdooien en opwarmen van bevroren maaltijden



300 - 400 W		
 Smelten van kaas, chocolade, boter	 Koken/opwarmen van delicaat voedsel	 Doorgaan met koken

100 - 200 W				
 Babyvoeding opwarmen	 Ontdooien van brood	 Ontdooien van fruit en gebak	 Ontdooien van kaas, room, boter	 Ontdooien van vlees, vis

10.5 Kooktafels voor testinstituten





Informatie voor testinstituten

Testen volgens IEC 60705.

MAGNETRON-FUNCTIE	POWER (W)	kg		 (min)	
Cake, zacht	600	0.475	Turntable-set	5 - 7	-
Gehaktbrood	500	0.9	Turntable-set	18 - 20	-
Bouillon met stukjes ei	500	1	Turntable-set	15 - 17	-
Ontdooien van vlees	200	0.5	Turntable-set	8 - 9	-

ONDERHOUD EN REINIGING

Gebruik de functie: Magnetrongrillen.
Gebruik het lage grillrooster.

COMBIMAGNETRON-FUNCTIE	 POWER (W)	 Intensiteitsniveau grill	 (min)	
Aardappelgratin, 1.1 kg	300	laag	30 - 35	-
Kip, 1.1 kg	300	hoog	30 - 35	Doe het vlees in een ronde glazen kom.

11. ONDERHOUD EN REINIGING



WAARSCHUWING!

Raadpleeg de hoofdstukken Veiligheid.

11.1 Opmerkingen over schoonmaken



Reinigingsmiddelen

Maak de voorkant van de oven schoon met een zachte doek, warm water en een mild reinigingsmiddel.

Gebruik een reinigungsoplossing om metalen oppervlakken te reinigen.

Reinig vlekken met een mild reinigingsmiddel.



Dagelijks gebruik

Reinig de uitsparing telkens na gebruik. Vetophoping of andere resten kunnen brand veroorzaken.
Reinig voorzichtig de bovenkant van de oven om resten en vet te verwijderen.

Bewaar het voedsel niet langer dan 20 minuten in de oven. Droog de uitsparing na elk gebruik met een zachte doek.



Accessoires

Reinig alle accessoires na elk gebruik en laat ze drogen. Wacht voor het reinigen tot het draaiplateau afgekoeld is. Er bestaat een risico dat het draaiplateau kan breken. Gebruik een zachte doek met warm water en een mild reinigingsmiddel. De accessoires niet in de afwasmachine reinigen.

Reinig de antiaanbakaccessoires niet met agressieve reinigungsmiddelen of scherpe voorwerpen.



12. PROBLEEMOPLOSSING





WAARSCHUWING!

Raadpleeg de hoofdstukken Veiligheid.

12.1 Wat te doen als...

 De oven gaat niet aan of warmt niet op	
 Mogelijke oorzaak	 Oplossing
De oven is niet aangesloten op een stopcontact of is niet goed geïnstalleerd.	Controleer of de oven goed is aangesloten op het lichtnet.
De klok is niet ingesteld.	Stel de klok in, raadpleeg voor meer informatie het hoofdstuk 'Klokfuncties', Instellen: Klokfuncties.
De deur is niet goed gesloten.	Sluit de deur volledig.
De zekering is doorgeslagen.	Ga na of de zekering de oorzaak van het probleem is. Als het probleem zich opnieuw voordoet, neem dan contact op met een gekwalificeerde elektricien.
Het Kinderslot van de oven is geactiveerd.	Raadpleeg het hoofdstuk 'Menu', Submenu voor: Opties.

 Onderdelen	
 Omschrijving	 Oplossing
De lamp is opgebrand.	Vervang de lamp, raadpleeg voor meer informatie het hoofdstuk 'Onderhoud en reiniging', Hoe te vervangen: Lamp.
De draaispitset maakt geluid.	Er bevinden zich voedselresten onder de draaiplateuset.

12.2 Hoe te beheren: Foutcodes

Wanneer de softwarefout optreedt, geeft het display een foutmelding weer.

ENERGIEZUINIGHEID

In deze sectie vindt u de lijst met problemen die u zelf kunt oplossen.

 Code en omschrijving	 Oplossing
F240, F439 - de aanraakvelden op het display werken niet goed.	Reinig het oppervlak van het display. Zorg ervoor dat er geen vuil op de aanraakvelden zit.
F908 - het ovensysteem kan geen verbinding maken met het bedieningspaneel.	Schakel de oven uit en in.

12.3 Servicegegevens

Als je niet zelf het probleem kunt verhelpen, neem dan contact op met je verkoper of een erkende serviceafdeling.

De contactgegevens van de servicedienst staan op het typeplaatje. Het typeplaatje bevindt zich aan de voorkant van de ovenruimte. Verwijder het typeplaatje niet uit de ovenruimte.

Wij raden je aan om de gegevens hier te noteren:	
Model (MOD.)
Productnummer (PNC)
Serienummer (S.N.)

13. ENERGIEZUINIGHEID

13.1 Energiebesparing

 Deze oven bevat functies die u helpen energie te besparen tijdens het dagelijks koken.

Zorg ervoor dat de ovendeur gesloten is als u de oven in werking stelt. Open de ovendeur niet te vaak tijdens gebruik. Houd het deurrubber schoon en zorg ervoor dat het goed op zijn plaats vastzit.

Verwarm de oven niet voor als het niet hoeft.

Houd onderbrekingen tussen het bakken zo kort mogelijk als je een aantal gerechten tegelijkertijd bereidt.

Koken met de verlichting uitgeschakeld

Schakel de verlichting tijdens het koken uit. Doe het aan als je het nodig hebt.

14. MENUSTRUCTUUR

14.1 Menu

Druk op  om te openen Menu.

Menu-item		Toepassing
Favorieten		Geeft een overzicht van de favoriete instellingen.
Opties		Voor het instellen van de ovenconfiguratie.
Instellingen	Instelling	Voor het instellen van de ovenconfiguratie.
	Service	Toont de softwareversie en -configuratie.

14.2 Submenu voor: Opties

Submenu	Toepassing
Binnenverlichting	Schakelt de lamp in en uit.
Kinderslot	Vorkomt accidentele activering van de oven. Wanneer de optie is ingeschakeld, verschijnt de tekst 'Kinderslot' op het scherm wanneer je de oven inschakelt. Om het ovengebruik in te schakelen, kies je de codeletters in alfabetische volgorde. Toegang tot de timer, de bediening op afstand en het lampje zijn beschikbaar met het kinderslot.
Tijdisindicatie	Schakelt de klok in en uit.
Digitale klokstijl	Wijzigt de indeling van de weergegeven tijdsaanduiding.

14.3 Submenu voor: Instelling

Submenu	Beschrijving
Taal	Stelt de taal van de oven in.
Helderheid display	Stelt de helderheid van de display in.
Toetstonen	Schakelt het geluid van de aanraakvelden in en uit. Het is niet mogelijk om de toon te dempen voor: ①.

HET IS HEEL GEMAKKELIJK!

Submenu	Beschrijving
Geluidsvolume	Stelt het volume van de belangrijkste geluiden en signalen in.
Dagtijd	Stelt de huidige tijd en datum in.

14.4 Submenu voor: Service





Submenu	Beschrijving
Demofunctie	Activerings-/deactiveringscode: 2468
Softwareversie	Informatie over softwareversie.
Terug naar fabrieksinstellingen	Herstelt fabrieksinstellingen.

15. HET IS HEEL GEMAKKELIJK!

Voorafgaand aan het eerste gebruik moet u het volgende instellen:





Taal	Helderheid display	Toetstonen	Geluidsvolume	Dagtijd
------	--------------------	------------	---------------	---------

Maak uzelf vertrouwd met de basispictogrammen op het bedieningspaneel en het display:





 Aan / UIT	 Menu	 Favorieten	 Timer	START / STOP
--	---	---	--	--------------

Start met het gebruik van de oven



MW snel starten	Start de magnetron op elk gewenst moment met de standaardinstellingen: 30 sec / 1000 W.	Druk op:  .
------------------------	---	--

			
---	---	---	---

HET IS HEEL GEMAKKELIJK!

verwarmen/koken 100 - 1000 W	koken/bruinen intensiteit: laag/hoog	koken/bruinen	vloeistoffen opwarmen 800 - 1000 W
			
opnieuw verwarmen 300 - 700 W	ontdooien 100 - 200 W	smelten 100 - 400 W	Popcorn maken 700 - 1000 W

Instellingen van de magnetron		Magnetrontips
Magnetronvermogen:	MAXIMUMTIJD:	Dek het voedsel voor bereiding en opwarming af. Draai het voedsel halverwege de ontdooi- en bereidingstijd om of roer het door. Plaats de lepel op de schaal bij het verwarmen van vloeistoffen. Plaats het voedsel in de oven zonder verpakkingsmateriaal (alleen veilig voor magnetron).
100 - 600 W	59 min	
> 600 W	7 min	

Begin met koken				
Stap 1	Stap 2	Stap 3	Stap 4	Stap 5
 - druk hierop om de oven in te schakelen.	 ... - selecteer de functie.	W - stel het magnetronvermogen in.	OK - druk hierop om te bevestigen.	START - druk hierop om te beginnen met koken.

Gebruik snelle functies om de kooktijd in te stellen	
10% Finish assist Gebruik 10% Finish assist om extra tijd toe te voegen wanneer 10% van de bereidingstijd overblijft.	Druk op +1min om de bereidingstijd te verlengen.

16. MILIEUBESCHERMING

Recycleer de materialen met het symbool . Gooi de verpakking in een geschikte afvalcontainer om het te recyclen. Bescherm het milieu en de volksgezondheid en recycleer op een correcte manier het afval van elektrische en elektronische apparaten. Gooi apparaten gemarkeerd met het symbool  niet weg met het huishoudelijk afval. Breng het product naar het milieustation bij u in de buurt of neem contact op met de gemeente.

Z MYŚLĄ O DOSKONAŁYCH EFEKTACH

Dziękujemy za wybór produktu AEG. Zaprojektowaliśmy go z myślą o wieloletniej bezawaryjnej pracy i wyposażyliśmy w innowacyjne rozwiązania techniczne ułatwiające życie – nie wszystkie z nich można znaleźć w zwykłych urządzeniach. Prosimy o poświęcenie kilku minut na zapoznanie się z niniejszą instrukcją, aby jak najlepiej wykorzystać możliwości urządzenia. Przejdź na naszą witrynę internetową:



Wskazówki dotyczące użytkowania, broszury, pomoc w rozwiązywaniu problemów oraz informacje dotyczące serwisu i napraw:

www.aeg.com/support



Zarejestruj produkt, aby korzystać z lepszej obsługi serwisowej:

www.registreaeg.com



Kup akcesoria, materiały eksploatacyjne i oryginalne części zamienne do swojego urządzenia:

www.aeg.com/shop

OBSŁUGA KLIENTA I SERWIS

Należy zawsze używać oryginalnych części zamiennych.

Przed kontaktem z autoryzowanym centrum serwisowym należy przygotować poniższe dane:

Model, numer produktu, numer seryjny.

Informacje można znaleźć na tabliczce znamionowej.

 Ostrzeżenie/przestroga — informacje dotyczące bezpieczeństwa

 Ogólne informacje i wskazówki

 Informacje dotyczące środowiska naturalnego

Producent zastrzega sobie możliwość wprowadzenia zmian bez wcześniejszego powiadomienia.

SPIS TREŚCI

1. INFORMACJE DOTYCZĄCE BEZPIECZEŃSTWA.....	271	2.6 Serwis.....	278
1.1 Bezpieczeństwo dzieci i osób o ograniczonych zdolnościach ruchowych, sensorycznych lub umysłowych.....	271	2.7 Utylizacja.....	278
1.2 Ogólne zasady bezpieczeństwa..	272	3. OPIS URZĄDZENIA.....	278
2. WSKAZÓWKI DOTYCZĄCE BEZPIECZEŃSTWA.....	275	3.1 Ogólne informacje.....	278
2.1 Instalacja.....	275	3.2 Akcesoria.....	279
2.2 Podłączenie elektryczne.....	276	4. WŁĄCZANIE I WYŁĄCZANIE PIEKARNIKA.....	279
2.3 Sposób używania.....	276	4.1 Panel sterowania.....	279
2.4 Konserwacja i czyszczenie.....	277	4.2 Wyświetlacz.....	280
2.5 Oświetlenie wewnętrzne.....	278	5. PRZED PIERWSZYM UŻYCIEM.....	281
		5.1 Czyszczenie wstępne	281
		5.2 Pierwsze połączenie.....	281

6. CODZIENNA EKSPLOATACJA.....	282	10.4 Zalecane ustawienia mocy dla różnych rodzajów potraw.....	291
6.1 Ustawianie funkcji: Grill + mikrofa-		10.5 Tabele pieczenia na potrzeby	
Grill.....	282	ośrodków przeprowadzających testy.	292
6.2 Jak ustawić: Funkcje pieczenia		11. KONSERWACJA I CZYSZCZENIE.....	293
kuchenki mikrofalowej.....	283	11.1 Uwagi dotyczące czyszczenia...	293
6.3 Sposób użycia: Szybkie		12. ROZWIĄZYWANIE PROBLEMÓW.....	294
uruchomienie kuchenki mikrofalowej.	284	12.1 Co zrobić, gdy.....	294
6.4 Funkcje pieczenia.....	284	12.2 Jak postępować: Kody błędów..	295
7. FUNKCJE ZEGARA.....	285	12.3 Dane serwisowe.....	295
7.1 Opis funkcji zegara.....	285	13. EFEKTYWNOŚĆ ENERGETYCZNA.....	296
7.2 Jak ustawić: Funkcje zegara.....	286	13.1 Oszczędzanie energii.....	296
8. SPOSÓB UŻYCIA: AKCESORIA.....	287	14. STRUKTURA MENU.....	296
8.1 Wkładanie akcesoriów.....	287	14.1 Menu.....	296
9. DODATKOWE FUNKCJE.....	288	14.2 Podmenu: Opcje.....	296
9.1 Jak zapisać ustawienia: Ulubione	288	14.3 Podmenu: Konfiguracja.....	297
9.2 Blokada panelu.....	288	14.4 Podmenu opcji: Serwis.....	297
9.3 Wentylator chłodzący.....	288	15. TO PROSTE!.....	298
10. WSKAZÓWKI I PORADY.....	289	16. OCHRONA ŚRODOWISKA.....	299
10.1 Zalecenia dotyczące pieczenia..	289		
10.2 Zalecenia dotyczące korzystania z			
mikrofal.....	289		
10.3 Odpowiednie naczynia i materiały			
do kuchenki mikrofalowej.....	290		

1. INFORMACJE DOTYCZĄCE BEZPIECZEŃSTWA

Przed przystąpieniem do instalacji i rozpoczęciem eksploatacji urządzenia należy uważnie zapoznać się z dołączoną instrukcją obsługi. Producent nie odpowiada za obrażenia ciała ani szkody spowodowane nieprawidłową instalacją lub eksploatacją produktu. Należy zachować instrukcję obsługi w bezpiecznym i łatwo dostępnym miejscu w celu wykorzystania w przyszłości.

1.1 Bezpieczeństwo dzieci i osób o ograniczonych zdolnościach ruchowych, sensorycznych lub umysłowych

- Urządzenie mogą obsługiwać dzieci po ukończeniu 8. roku życia oraz osoby o ograniczonych zdolnościach fizycznych,

sensorycznych lub umysłowych bądź nieposiadające odpowiedniej wiedzy i doświadczenia, jeśli będą one nadzorowane lub zostaną poinstruowane w zakresie bezpiecznego korzystania z tego urządzenia i będą świadome związanych z tym zagrożeń. Dzieci w wieku poniżej 8 lat i osoby o znacznym stopniu niepełnosprawności nie powinny zbliżać się urządzenia, jeśli nie znajdują się pod stałym nadzorem.

- Dzieci należy pilnować, aby nie bawiły się urządzeniem.
- Przechowywać opakowanie w miejscu niedostępnym dla dzieci lub pozbyć się go w odpowiedni sposób.
- **OSTRZEŻENIE:** Nie pozwalać dzieciom i zwierzętom zbliżać się do pracującego lub stygnącego urządzenia. Podczas pracy urządzenia niektóre jego elementy mocno się nagrzewają.
- Jeśli urządzenie wyposażono w blokadę uruchomienia, zaleca się jej włączenie.
- Dzieci nie powinny zajmować się czyszczeniem ani konserwacją urządzenia bez odpowiedniego nadzoru.

1.2 Ogólne zasady bezpieczeństwa

- Urządzenie jest przeznaczone wyłącznie do stosowania w kuchni.
- Urządzenie to przeznaczone jest do użytku domowego w pomieszczeniach zamkniętych.
- Urządzenie to można używać w biurach, pokojach hotelowych, pokojach w pensjonatach, domach dla gości w gospodarstwach rolnych i innych podobnych miejscach, gdzie użytkowanie nie przekracza średniego poziomu użytkowania w gospodarstwie domowym.
- Instalacji urządzenia i wymiany jego przewodu zasilającego może dokonać wyłącznie osoba o odpowiednich kwalifikacjach.
- Nie uruchamiać urządzenia przed zainstalowaniem go w zabudowie.

INFORMACJE DOTYCZĄCE BEZPIECZEŃSTWA

- Przed przystąpieniem do jakichkolwiek czynności konserwacyjnych należy odłączyć urządzenie od zasilania.
- Jeśli przewód zasilający jest uszkodzony, musi go wymienić producent, autoryzowane centrum serwisowe lub inna wykwalifikowana osoba, aby zapobiec ryzyku porażenia prądem.
- **OSTRZEŻENIE:** Przed przystąpieniem do wymiany żarówki należy upewnić się, że urządzenie jest wyłączone, aby uniknąć porażenia prądem elektrycznym.
- **OSTRZEŻENIE:** Podczas działania urządzenia jego nieosłonięte elementy nagrzewają się do wysokiej temperatury. Należy zachować ostrożność, aby nie dotknąć elementów grzejnych.
- Do wyjmowania lub wkładania akcesoriów i naczyń należy zawsze używać rękawic kuchennych.
- Należy stosować wyłącznie talerz obrotowy i podstawę talerza obrotowego zaprojektowane do tego urządzenia.
- Nie włączać funkcji kuchenki mikrofalowej, gdy urządzenie jest puste. Metalowe części wewnątrz komory mogą spowodować powstanie łuku elektrycznego.
- Podczas gotowania w kuchence mikrofalowej nie można używać metalowych pojemników na żywność lub napoje. Ograniczenie to nie obowiązuje, jeśli producent określi rozmiar i kształt metalowych pojemników przeznaczonych do gotowania w kuchence mikrofalowej.
- **OSTRZEŻENIE:** Jeśli nastąpi uszkodzenie drzwi lub ich uszczelki, urządzenie nie może być używane do czasu naprawy przez wykwalifikowaną osobę.
- **OSTRZEŻENIE:** Tylko wykwalifikowana osoba może wykonywać czynności serwisowe lub naprawcze związane z demontażem osłony zapewniającej ochronę przed narażeniem na działanie energii mikrofalowej.
- **OSTRZEŻENIE:** Nie podgrzewać cieczy ani żadnych potraw w szczelnych pojemnikach. Mogą one wybuchnąć.

INFORMACJE DOTYCZĄCE BEZPIECZEŃSTWA

- Należy stosować wyłącznie akcesoria i naczynia przeznaczone do kuchenek mikrofalowych.
- Podgrzewając żywność w pojemnikach z papieru lub tworzywa, należy obserwować urządzenie, ponieważ występuje zagrożenie zapłonem.
- Urządzenie jest przeznaczone do podgrzewania żywności i napojów. Suszenie żywności lub odzieży oraz podgrzewanie podkładek podgrzewających, pantofli, gąbek, wilgotnej szmatki i podobnych elementów może prowadzić do obrażeń ciała, zapalenia lub pożaru.
- Jeśli z urządzenia wydobywa się dym, należy je wyłączyć lub odłączyć od zasilania i pozostawić zamknięte drzwi w celu wypalenia płomienia.
- Podgrzewanie napojów w kuchence mikrofalowej może spowodować opóźnione wrzenie z erupcją. Należy zachować ostrożność przy obchodzeniu się z pojemnikiem.
- Zawartość butelek do karmienia i słoików dla niemowląt należy wymieszać lub wstrząsnąć, a następnie sprawdzić temperaturę przed spożyciem, aby uniknąć poparzenia.
- Jajka w skorupkach i całe jajka nie powinny być podgrzewane w urządzeniu, ponieważ mogą eksplodować, nawet po zakończeniu podgrzewania w kuchence mikrofalowej.
- Urządzenie należy regularnie czyścić i usuwać wszelkie pozostałości żywności.
- Do czyszczenia urządzenia nie wolno używać sprzętów czyszczących parą.
- Do czyszczenia szyb w drzwiach nie używać ściernych środków czyszczących ani ostrych, metalowych myjek, ponieważ mogą one porysować powierzchnię, co może skutkować pęknięciem szkła.
- Nieutrzymywanie urządzenia w czystym stanie może spowodować pogorszenie stanu jego powierzchni, co może negatywnie wpływać na żywotność urządzenia i spowodować niebezpieczną sytuację.

2. WSKAZÓWKI DOTYCZĄCE BEZPIECZEŃSTWA

2.1 Instalacja



OSTRZEŻENIE!

Urządzenie może zainstalować wyłącznie wykwalifikowana osoba.

- Usunąć wszystkie elementy opakowania.
- Nie instalować ani nie używać uszkodzonego urządzenia.
- Należy postępować zgodnie z instrukcją instalacji dołączoną do urządzenia.
- Zachować ostrożność podczas przenoszenia urządzenia, ponieważ jest ono ciężkie. Należy zawsze stosować rękawice ochronne i mieć na stopach pełne obuwie.
- Nigdy nie ciągnąć urządzenia za uchwyt.
- Zainstalować urządzenie w odpowiednim i bezpiecznym miejscu, które spełnia wymagania instalacyjne.
- Zachować minimalne odstępów od innych urządzeń i mebli.
- Przed zamontowaniem urządzenia należy sprawdzić, czy drzwi otwierają się bez oporu.
- Urządzenie wyposażono w elektryczny układ chłodzenia. Układ zasilany jest napięciem elektrycznym.
- Urządzenie do zabudowy musi spełniać wymogi dotyczące stabilności DIN 68930.

Minimalna wysokość szafki (minimalna wysokość szafki pod blatem)	444 (460) mm
Szerokość szafki	560 mm
Głębokość szafki	550 (550) mm
Wysokość przedniej części urządzenia	455 mm
Wysokość tylnej części urządzenia	440 mm
Szerokość przedniej części urządzenia	595 mm
Szerokość tylnej części urządzenia	559 mm
Głębokość urządzenia	567 mm
Głębokość części urządzenia do zabudowy	546 mm
Głębokość z otworzonymi drzwiami	882 mm
Minimalna wielkość otworu wentylacyjnego. Otwór umieszczony na dole z tyłu	560x20 mm
Długość przewodu zasilającego Przewód jest umiejscowiony w prawym tylnym rogu	1500 mm

WSKAZÓWKI DOTYCZĄCE BEZPIECZEŃSTWA

Wkręty mocujące	3.5x25 mm
-----------------	-----------

2.2 Podłączenie elektryczne



OSTRZEŻENIE!

Zagrożenie pożarem i porażeniem prądem elektrycznym.

- Wszystkie połączenia elektryczne powinien wykonać wykwalifikowany elektryk.
- Urządzenie musi być uziemione.
- Upewnić się, że parametry na tabliczce znamionowej odpowiadają parametrom znamionowym źródła zasilania.
- Należy używać wyłącznie prawidłowo zamontowanego gniazda elektrycznego z uziemieniem.
- Nie stosować rozgałęźników ani przedłużaczy.
- Należy zwrócić uwagę, aby nie uszkodzić wtyczki ani przewodu zasilającego. Wymiany przewodu zasilającego można dokonać wyłącznie w naszym autoryzowanym centrum serwisowym.
- Przewody zasilające nie mogą dotykać ani przebiegać w pobliżu drzwi urządzenia lub wnęki pod urządzeniem, zwłaszcza gdy urządzenie działa i drzwi są mocno rozgrzane.
- Zarówno dla elementów znajdujących się pod napięciem, jak i zaizolowanych części, zabezpieczenie przed porażeniem prądem należy zamocować w taki sposób, aby nie można go było odłączyć bez użycia narzędzi.
- Podłączyć wtyczkę do gniazda elektrycznego dopiero po zakończeniu instalacji. Należy zadbać o to, aby po zakończeniu instalacji urządzenia wtyczka przewodu zasilającego była łatwo dostępna.
- Jeśli gniazdo elektryczne jest obluźwane, nie wolno podłączać do niego wtyczki.
- Odłączając urządzenie, nie należy ciągnąć za przewód zasilający. Należy zawsze ciągnąć za wtyczkę sieciową.
- Konieczne jest zastosowanie odpowiednich wyłączników obwodu zasilania: wyłączników automatycznych, bezpieczników topikowych (typu wykręcanego – wyjmowanych z oprawki), wyłączników różnicowoprądowych oraz styczników.
- W instalacji elektrycznej należy zastosować wyłącznik obwodu umożliwiający odłączenie urządzenia od zasilania na wszystkich biegunach. Wyłącznik obwodu musi mieć rozwarście styków wynoszące minimum 3 mm.
- Urządzenie wyposażono w przewód zasilający oraz wtyczkę.

2.3 Sposób używania



OSTRZEŻENIE!

Zagrożenie odniesieniem obrażeń, oparzeniem, porażeniem prądem lub wybuchem.

- Nie zmieniać parametrów technicznych urządzenia.
- Upewnić się, że otwory wentylacyjne są drożne.
- Nie pozostawiać urządzenia bez nadzoru podczas pracy.
- Wyłączyć urządzenie po każdym użyciu.
- Zachować ostrożność podczas otwierania drzwi, gdy urządzenie pracuje. Może dojść do uwolnienia gorącego powietrza.
- Nie wolno obsługiwać urządzenia mokrymi rękami lub gdy ma ono kontakt z wodą.

WSKAZÓWKI DOTYCZĄCE BEZPIECZEŃSTWA

- Nie naciskać na otworzone drzwi.
- Nie używać urządzenia jako powierzchni roboczej ani miejsca do przechowywania.
- Ostrożnie otworzyć drzwi urządzenia. Stosowanie składników zawierających alkohol może powodować zmieszanie alkoholu i powietrza.
- Podczas otwierania drzwi urządzenia nie wolno dopuszczać do kontaktu iskier lub otwartego płomienia z urządzeniem.
- Nie umieszczać produktów łatwopalnych ani przedmiotów nasączonych łatwopalnymi produktami w pobliżu lub na urządzeniu.
- Nie używać funkcji kuchenki mikrofalowej do wstępnego ogrzania piekarnika.



OSTRZEŻENIE!

Zagrożenie uszkodzeniem urządzenia.

- Aby zapobiec uszkodzeniu lub przebarwieniu się emalii:
 - Nie należy kłaść folii aluminiowej bezpośrednio na dnie komory urządzenia.
 - Nie wlewać wody bezpośrednio do gorącego urządzenia.
 - Nie należy pozostawiać wilgotnych naczyń ani potraw w urządzeniu po zakończeniu pieczenia.
 - Podczas wyjmowania lub wyjmowania akcesoriów należy zachować ostrożność.
- Odbarwienie emalii lub stali nierdzewnej nie ma wpływu na działanie urządzenia.
- Należy zawsze gotować z zamkniętymi drzwiczkami urządzenia.
- Jeśli urządzenie zainstalowano za ścianką meblową (np. za drzwiami szafki), nie wolno zamykać drzwi podczas pracy urządzenia. Połączenie wysokiej temperatury i wilgoci wewnątrz zamkniętego mebla może doprowadzić do uszkodzenia urządzenia, mebla lub podłogi. Nie zamykać drzwi szafki do czasu całkowitego ostygnięcia urządzenia.

2.4 Konserwacja i czyszczenie



OSTRZEŻENIE!

Zagrożenie odniesieniem obrażeń, pożarem lub uszkodzeniem urządzenia.

- Przed przystąpieniem do konserwacji należy wyłączyć urządzenie i wyjąć wtyczkę przewodu zasilającego z gniazda elektrycznego.
- Upewnić się, że urządzenie ostygło. Występuje zagrożenie pęknięciem szyb w drzwiach urządzenia.
- Jeśli szyba pęknie, należy ją niezwłocznie wymienić. Należy skontaktować się z autoryzowanym centrum serwisowym.
- Przy zdejmowaniu drzwi urządzenia należy zachować ostrożność. Drzwi są ciężkie!
- Po każdym użyciu wytrzeć do sucha komorę, talerz obrotowy i drzwi. Para powstała w wyniku działania urządzenia skrapla się na ściankach komory i może powodować korozję.
- Aby zapobiec uszkodzeniu powierzchni urządzenia, należy regularnie ją czyścić.
- Resztki tłuszczu i potraw w urządzeniu mogą być przyczyną powstania pożaru lub łuku elektrycznego podczas działania funkcji kuchenki mikrofalowej.
- Czyścić urządzenie za pomocą wilgotnej szmatki. Stosować wyłącznie obojętne detergenty. Nie używać produktów ściernych, myjek do szorowania, rozpuszczalników ani metalowych przedmiotów.
- Stosując aerozol do piekarników, należy przestrzegać wskazówek dotyczących bezpieczeństwa umieszczonych na jego opakowaniu.

OPIS URZĄDZENIA

2.5 Oświetlenie wewnętrzne



OSTRZEŻENIE!

Zagrożenie porażeniem prądem.

- Informacja dotycząca oświetlenia w urządzeniu i elementów oświetleniowych sprzedawanych osobno jako części zamienne: Zastosowane elementy oświetleniowe są przystosowane do pracy w wymagających warunkach fizycznych (temperatura, drgania, wilgotność) w urządzeniach domowych lub są przeznaczone do sygnalizacji stanu działania urządzenia. Nie są one przeznaczone do innych zastosowań i nie nadają się do oświetlania pomieszczeń domowych.
- W ten produkt wbudowano źródło światła o klasie efektywności energetycznej G.
- Używać wyłącznie żarówek tego samego typu.

2.6 Serwis

- Aby naprawić urządzenie, należy skontaktować się z autoryzowanym centrum serwisowym.
- Należy stosować wyłącznie oryginalne części zamienne.

2.7 Utylizacja



OSTRZEŻENIE!

Zagrożenie odniesieniem obrażeń lub uduszeniem.

- Aby uzyskać informacje dotyczące prawidłowej utylizacji produktu, należy skontaktować się z lokalnymi władzami.
- Odłączyć urządzenie od źródła zasilania.
- Odciąć przewód zasilający blisko urządzenia i oddać do utylizacji.
- Wymontować zatrzask drzwi, aby uniemożliwić zamknięcie się dziecka lub zwierzęcia w urządzeniu.

3. OPIS URZĄDZENIA

3.1 Ogólne informacje

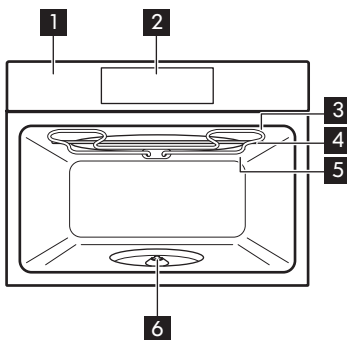

- 1** Panel sterowania
- 2** Wyświetlacz
- 3** Grzałka
- 4** Generator mikrofal
- 5** Lampa
- 6** Wałek talerza obrotowego

WŁĄCZANIE I WYŁĄCZANIE PIEKARNIKA

3.2 Akcesoria

Zestaw talerza obrotowego

Do przyrządzania potraw.

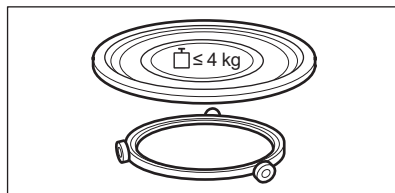

Zestaw podstawki do grillowania

Do grillowania.

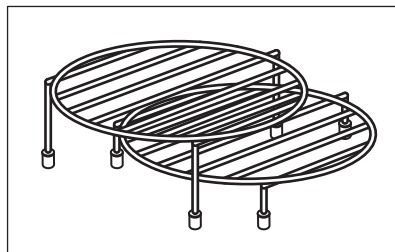

4. WŁĄCZANIE I WYŁĄCZANIE PIEKARNIKA

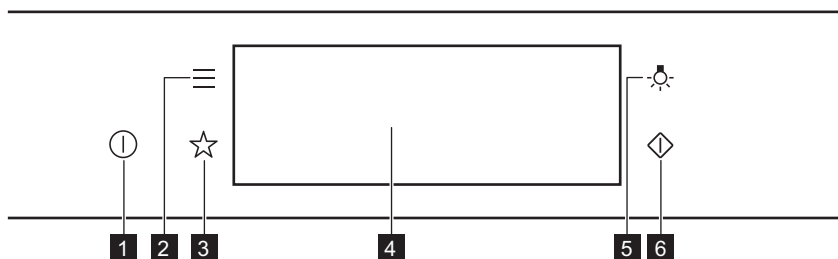

4.1 Panel sterowania





1	Włączone / Wyłączone	Nacisnąć i przytrzymać, aby włączyć lub wyłączyć piekarnik.
2	Menu	Wyświetlenie listy funkcji piekarnika.
3	Ulubione	Wyświetlenie listy ulubionych ustawień.
4	Wyświetlacz	Pokazuje aktualne ustawienia piekarnika.
5	Przełącznik oświetlenia	Włączanie i wyłączanie oświetlenia.

WŁĄCZANIE I WYŁĄCZANIE PIEKARNIKA

6	Szybkie uruchomienie kuchenki mikrofalowej	Włączenie funkcji kuchenki mikrofalowej (1000 W, 30 sekund).
----------	--	--

		
Naciskaj przycisk	Przesunięcie	Nacisnąć i przytrzymać
Dotknąć powierzchni placem.	Przesunąć palcem po powierzchni.	Dotknąć powierzchni przez 3 sekundy.

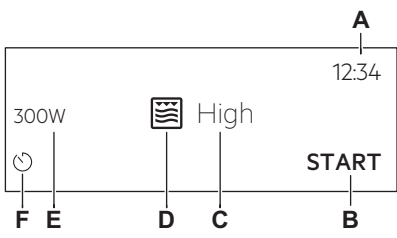
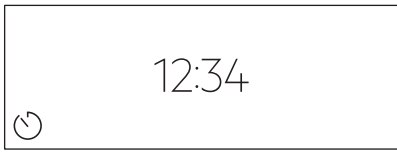







4.2 Wyświetlacz

	<p>Po włączeniu wyświetlacz pokazuje ekran główny z funkcją i domyślną intensywnością grillowania.</p> <p>A. Aktualna godzina B. START/STOP C. Intensywność grilla D. Funkcje pieczenia E. Moc mikrofal F. Timer</p>
	<p>Jeśli użytkownik nie wykona żadnej czynności przez 2 minuty, wyświetlacz przełączy się w tryb czuwania.</p>
	<p>Podczas pieczenia wyświetlacz pokazuje ustalone funkcje i inne dostępne opcje.</p>

Wskaźniki na wyświetlaczu

Podstawowe wskaźniki – służą do obsługi wyświetlacza.

PRZED PIERWSZYM UŻYCIEM

 Potwierdzenie wyboru lub ustawienia.	 Powrót do poprzedniego poziomu menu.	 Anulowanie ostatniej czynności.	 Włączanie i wyłączanie opcji.
Wskaźniki Alarm dźwiękowy – po upływie ustawionego czasu pieczenia rozlegnie się sygnał dźwiękowy.			
 Funkcja jest włączona.	 Funkcja jest włączona. Pieczenie kończy się automatycznie.	 Alarm dźwiękowy jest wyłączony.	
Wskaźniki timera			
 Aby ustawić funkcję: Uruchomienie z opóźnieniem.		 Anulowanie ustawienia.	



5. PRZED PIERWSZYM UŻYCIEM



OSTRZEŻENIE!

Patrz rozdział dotyczący bezpieczeństwa.

5.1 Czyszczenie wewnętrzne

		
Krok 1	Krok 2	Krok 3
Wyjąć wszystkie akcesoria z piekarnika.	Umyć piekarnik i akcesoria miękką szmatką zwilżoną ciepłą wodą z dodatkiem łagodnego detergentu.	Umieścić akcesoria w piekarniku.

5.2 Pierwsze połączenie

Po podłączeniu urządzenia po raz pierwszy do zasilania na wyświetlaczu pojawi się wiadomość powitalna.

Należy ustawić: Język, Jasność wyświetlacza, Dźwięki przycisków, Głośność sygnału, Aktualna godzina.

6. CODZIENNA EKSPLOATACJA



OSTRZEŻENIE!

Patrz rozdział dotyczący bezpieczeństwa.

6.1 Ustawianie funkcji: Grill + mikrofalę, Grill

Urządzenie może wydawać charakterystyczne odgłosy podczas działania funkcji: Grill + mikrofalę. Jest to normalne zjawisko.

Ustawianie funkcji: Grill + mikrofalę	
Krok 1	Włożyć dolny ruszt do grillowania.
Krok 2	Włączyć piekarnik. Na wyświetlaczu pojawi się domyślna funkcja pieczenia.
Krok 3	Nacisnąć symbol funkcji pieczenia, aby przejść do podmenu.
Krok 4	Wybrać funkcję:  . Nacisnąć przycisk: OK.
Krok 5	Wybrać poziom intensywności grilla.
Funkcja	Poziom intensywności działania grilla
Lo	Niska
Hi	Wysoka
Krok 6	Nacisnąć: OK.
Krok 7	Nacisnąć: START .
STOP – nacisnąć, aby wyłączyć piekarnik.	
Krok 8	Wyłączyć piekarnik.

Moc mikrofal jest ograniczona do 500 W, gdy działa funkcja: Grill + mikrofalę.

Ustawianie funkcji: Grill	
Krok 1	Włożyć ruszt do grillowania.
Krok 2	Włączyć piekarnik. Na wyświetlaczu pojawi się domyślna funkcja pieczenia.
Krok 3	Nacisnąć symbol funkcji pieczenia, aby przejść do podmenu.

Ustawianie funkcji: Grill	
Krok 4	Wybrać funkcję:  . Nacisnąć przycisk: OK.
Krok 5	Wybrać poziom intensywności grilla.
Funkcja	Poziom intensywności działania grilla
Lo	Niska
Hi	Wysoka
Krok 6	Nacisnąć: OK.
Krok 7	Nacisnąć: START .
STOP – nacisnąć, aby wyłączyć funkcję.	
Krok 8	Wyłączyć piekarnik.

6.2 Jak ustawić: Funkcje pieczenia kuchenki mikrofalowej

Krok 1	Włączyć piekarnik.
Krok 2	Nacisnąć symbol funkcji pieczenia, aby przejść do podmenu.
Krok 3	Wybrać funkcję pieczenia mikrofal i nacisnąć: OK. Na wyświetlaczu pojawia się wskazanie mocy mikrofal.
Krok 4	Ustawienie: moc mikrofal. Nacisnąć: OK.
Krok 5	Nacisnąć: START .
STOP – nacisnąć, aby wyłączyć funkcję.	
Krok 6	Wyłączyć piekarnik.

Maksymalny czas działania funkcji kuchenki mikrofalowej zależy od ustawienia mocy mikrofal:

CODZIENNA EKSPLOATACJA

MOC MIKROFAL	MAKSYMALNY CZAS
100–600 W	59 minuty
Powyżej 600 W	7 minut

 Otworzenie drzwi powoduje zatrzymanie funkcji. Aby ponownie uruchomić urządzenie, należy nacisnąć przycisk **START**.

Można użyć skrótu!





6.3 Sposób użycia: Szybkie uruchomienie kuchenki mikrofalowej

Krok 1	Nacisnąć i przytrzymać:  . Kuchenka mikrofalowa uruchomi się na 30 sekund.	
Krok 2	Aby wydłużyć czas gotowania:	
	Nacisnąć wartość odliczanego czasu, aby przejść do ustawień czasu. Ustawić czas gotowania.	Nacisnąć +30 s.

Kuchenkę mikrofalową można włączyć w dowolnej chwili za pomocą: Szybkie uruchomienie kuchenki mikrofalowej.





6.4 Funkcje pieczenia

STANDARDOWE

Funkcja pieczenia	Zastosowanie
 Grill	Do grillowania cienkich porcji potraw i opiekania chleba.
 Grill + mikrofalę	Do szybkiego pieczenia i przyrumieniania potraw. Do wyboru są 2 poziomy mocy grilla: niska i wysoka.

Funkcja pieczenia	Zastosowanie
 Mikrofałe	Podgrzewanie, gotowanie, zakres mocy: 100 - 1000 W

MIKROFAŁE

Funkcja pieczenia	Zastosowanie
 Rozmrażanie	Rozmrażanie mięsa, ryb, ciast, zakres mocy: 100 - 200 W
 Roztapianie	Roztapianie czekolady i masła, zakres mocy: 100 - 400 W
 Odgrzewanie	Podgrzewanie dań gotowych i delikatnych, zakres mocy: 300 - 700 W
 Popcorn	Przygotowanie popcornu, zakres mocy: 700 - 1000 W
 Produkty płynne	Podgrzewanie napojów i zup, zakres mocy: 800 - 1000 W

7. FUNKCJE ZEGARA

7.1 Opis funkcji zegara

Funkcja zegara	Zastosowanie
Czas pieczenia	Ustawianie czasu pieczenia Maksymalna wartość: 23 godz. i 59 minut
Zakończ działanie	Ustawianie czynności po zakończeniu odliczania przez zegar
Wydłużenie czasu	Wydłużenie czasu pieczenia

FUNKCJE ZEGARA

Funkcja zegara	Zastosowanie
Przypomnienie	Ustawianie odliczania Maksymalna wartość: 23 godz. i 59 min. Funkcja ta nie ma wpływu na działanie piekarnika.
Stoper	Monitoruje czas działania funkcji. Stoper – można włączyć i wyłączyć.

7.2 Jak ustawić: Funkcje zegara

Ustawianie zegara	
Krok 1	Nacisnąć: Aktualna godzina.
Krok 2	Ustawić czas. Nacisnąć: OK.

Jak ustawić czas pieczenia	
Krok 1	Wybrać funkcję pieczenia.
Krok 2	Nacisnąć:  .
Krok 3	Ustawić czas. Nacisnąć: OK.

Wybór opcji zakończenia pieczenia	
Krok 1	Wybrać funkcję pieczenia.
Krok 2	Nacisnąć:  .
Krok 3	Ustawić czas pieczenia.
Krok 4	Nacisnąć: ● ● ● .
Krok 5	Nacisnąć: Zakończ działanie.
Krok 6	Wybrać preferowane: Zakończ działanie.
Krok 7	Nacisnąć: OK. Powtarzać tę czynność do czasu wyświetlenia się ekranu głównego.

Jak wydłużyć czas pieczenia

Po upływie 90% czasu pieczenia, jeśli potrawa nie jest jeszcze gotowa, można wydłużyć czas pieczenia. Można również zmienić funkcję pieczenia.

Nacisnąć **+1 min**, aby wydłużyć czas pieczenia.

Jak zmienić ustawienia timera

Krok 1 Nacisnąć: .

Krok 2 Ustawić wartość dla timera.

Krok 3 Nacisnąć: **OK**.

Podczas pieczenia można w dowolnej chwili zmienić ustawienie czasu.

8. SPOSÓB UŻYCIA: AKCESORIA

8.1 Wkładanie akcesoriów

Używać wyłącznie naczynia z odpowiednich materiałów. Patrz rozdział „Wskazówki i porady”, Naczynia i materiały odpowiednie do kuchenki mikrofalowej.

Zestaw talerza obrotowego:

Zawsze gotować potrawy na talerzu obrotowym.

Założyć prowadnicę rolkową na wałek stołu obrotowego. Umieścić talerz obrotowy na prowadnicy z rolkami.

Należy wyłącznie używać zestawu talerza obrotowego dostarczonego z piekarnikiem.

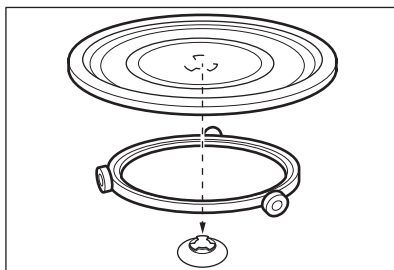

Zestaw podstawki do grillowania:

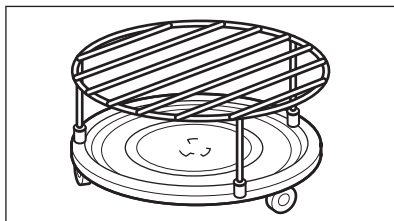

Ustawić podstawkę do grillowania, tak aby silikonowe nakładki były skierowane w dół, na talerzu obrotowym.



9. DODATKOWE FUNKCJE



9.1 Jak zapisać ustawienia: Ulubione

Można zapisać ulubione ustawienia, takie jak: funkcja pieczenia, czas pieczenia czy funkcja czyszczenia. W pamięci można zapisać 3 ulubione ustawienia.

Krok 1	Włączyć piekarnik.
Krok 2	Wybrać preferowane ustawienie.
Krok 3	Nacisnąć:  . Wybrać: Ulubione.
Krok 4	Wybrać opcję: Zapisz aktualne ust..
Krok 5	Nacisnąć +, aby dodać ustawienie do listy: Ulubione. Nacisnąć przycisk OK.
 – nacisnąć, aby zresetować ustawienie.  – nacisnąć, aby anulować ustawienie.	

9.2 Blokada panelu

Funkcja ta zapobiega przypadkowej zmianie funkcji pieczenia.

Krok 1	Włączyć piekarnik.
Krok 2	Ustawić funkcję pieczenia.
Krok 3	  — nacisnąć jednocześnie, aby włączyć funkcję.
Aby wyłączyć funkcję, należy powtórzyć krok 3.	

9.3 Wentylator chłodzący

Podczas pracy piekarnika wentylator chłodzący włącza się automatycznie, aby utrzymywać powierzchnię piekarnika w niskiej temperaturze. Po wyłączeniu piekarnika wentylator chłodzący działa do czasu ostygnięcia piekarnika.

10. WSKAZÓWKI I PORADY

10.1 Zalecenia dotyczące pieczenia



Temperatury i czasy gotowania podane w tabelach mają wyłącznie charakter orientacyjny. Zależą one od przepisów oraz jakości i ilości użytych składników.

Nowy piekarnik może piec inaczej niż dotychczas używany. Poniższe wskazówki pokazują zalecane funkcje podgrzewania i ustawienia czasu gotowania dla określonych rodzajów żywności.

W przypadku braku ustawień dla specjalnego przepisu należy znaleźć ustawienia dla podobnej potrawy.

Więcej zaleceń dotyczących pieczenia jest dostępnych w naszej witrynie internetowej. Aby znaleźć odpowiednie wskazówki dotyczące pieczenia, należy sprawdzić numer produktu (PNC) podany na tabliczce znamionowej umieszczonej na obramowaniu komory piekarnika.

10.2 Zalecenia dotyczące korzystania z mikrofal

Czas na gotowanie!

Nie umieszczaj potraw bezpośrednio na talerzu obrotowym. Należy zawsze używać naczyń przystosowanych do gotowania w kuchence mikrofalowej.

Postawić naczynie na środku talerza obrotowego.

Zetknięcie ze zbyt zimnym lub zbyt ciepłym naczyniem może spowodować pęknięcie talerza obrotowego.

Obrócić lub zamieszać potrawę po upływie połowy czasu rozmrażania lub gotowania.

Potrawy płynne należy od czasu do czasu zamieszać.

Zamieszać potrawę przed podaniem.

Przykryć potrawę na czas gotowania lub odgrzewania.

Podczas podgrzewania napojów włożyć łyżkę do butelki lub szklanki, aby zapewnić lepsze rozprzewadzenie ciepła.

Włożyć do piekarnika potrawę bez opakowania. Pakowane gotowe potrawy można wkładać do piekarnika w opakowaniu, gdy jest ono przeznaczone do kuchenek mikrofalowych (patrz informacje na opakowaniu).



Gotowanie za pomocą mikrofal

Gotować pod przykryciem. Potrawy można gotować bez przykrycia, jeśli ich wierzch ma być przypieczony.

Nie należy przegrzewać potraw, ustawiając za wysoką moc i zbyt długi czas. Może to spowodować wysuszenie, przypalenie lub zapalenie się potrawy.

Nie gotować w piekarniku ślimaków w muszlach ani jajek w skorupkach, ponieważ mogą wybuchnąć. Przed odgrzewaniem sadzonych jajek należy przekłuć żółtko.

Przed gotowaniem potraw ze skórką należy je kilkakrotnie nakłuć.

Warzywa pokroić na kawałki podobnej wielkości.

Po wyłączeniu piekarnika wyjąć potrawę i odstawić na kilka minut w celu równomiernego rozprzewadzenia ciepła.



Rozmrażanie za pomocą mikrofal

Mrożone, pozbawione opakowania mięso położyć na odwróconym małym talerzu, umieszczonym w większym pojemniku lub na ruszcie do rozmrażania bądź plastikowym sicie, aby umożliwić spływanie płynu powstającego podczas rozmrażania.





Wyjmować po kolei rozmrożone kawałki.





Aby ugotować warzywa i owoce bez ich uprzedniego rozmrażania, należy użyć wyższej mocy mikrofal.

10.3 Odpowiednie naczynia i materiały do kuchenki mikrofalowej

Do gotowania w kuchenke mikrofalowej używać tylko materiałów i naczyń do tego przeznaczonych. Patrz poniższa tabela.



Przed użyciem należy sprawdzić naczynie lub właściwości materiału, z którego wykonane jest naczynie.







Naczynia/materiał				
Szkoło i porcelana odporne na wysoką temperaturę, bez metalowych elementów, np. szkło żaroodporne	✓	✓	✓	✓
Szkoło i porcelana nieodporne na wysoką temperaturę bez srebrnych, złotych, platynowych lub innych metalowych elementów	✓	X	X	X
Szkoło i szkło ceramiczne z materiałów odpornych na wysoką i niską temperaturę	✓	✓	✓	✓
Materiały ceramiczne bez kwarcowych i metalowych elementów oraz szkliska z zawartością metalu	✓	✓	X	X
Materiały ceramiczne, porcelana i fajans z niepowlekanym dnem lub z małymi otworami np. w uchwytach	X	X	X	X
Tworzywo sztuczne odporne wysoką temperaturę do 200°C	✓	✓	X	X
Karton, papier	✓	X	X	X

Naczynia/materiał				
Folia	✓	X	X	X
Folia do pieczenia z zamknięciem nadającym się do kuchenek mikrofalowych	✓	✓	X	X
Naczynia do pieczenia z metalu, np. emaliowane, żeliwne	X	X	✓	X
Formy do pieczenia lakierowane na czarno lub z powłoką silikonową	X	X	✓	X
Naczynia przeznaczone do kuchenek mikrofalowych, np. talerz Crisp	X	✓	X	X
Zestaw podstawki do grillowania	X	X	✓	✓

10.4 Zalecane ustawienia mocy dla różnych rodzajów potraw





Dane przedstawione w tabeli mają wyłącznie charakter orientacyjny.

800 - 1000 W	
 Smażenie na początku procesu gotowania	 Podgrzewanie płynów

500 - 700 W					
 Gotowanie warzyw	 Gotowanie jajek	 Powolne gotowanie	 Gotowanie ryżu	 Podgrzewanie potraw na jednym talerzu	 Rozmrażanie i podgrzewanie zamrożonych potraw

WSKAZÓWKI I PORADY





300 - 400 W		
 Roztapianie sera, czekolady, masła	 Gotowanie/podgrzewanie delikatnych potraw	 Dalsze gotowanie

100 - 200 W				
 Podgrzewanie potraw dla niemowląt	 Rozmrażanie chleba	 Rozmrażanie owoców i ciast	 Rozmrażanie sera, śmietany, masła	 Rozmrażanie mięsa, ryb





10.5 Tabele pieczenia na potrzeby ośrodków przeprowadzających testy

Informacja dla instytucji wykonujących testy

Testy zgodne z normą IEC 60705

FUNKCJA KUCHENKI MIKROFALOWEJ	 POWER (W)	 (kg)		 (min)	
Biszkopt	600	0.475	Zestaw talerza obrotowego	5 - 7	-
Klops	500	0.9	Zestaw talerza obrotowego	18 - 20	-
Krem jajeczny	500	1	Zestaw talerza obrotowego	15 - 17	-
Rozmrażanie mięsa	200	0.5	Zestaw talerza obrotowego	8 - 9	-

**Użyć funkcji: Grillowanie mikrofalami.
Użyć podstawki do grillowania.**

FUNKCJA KOMBI KUCHENKI MIKROFALOWEJ	 POWER (W)	 Poziom intensywności działania grilla	 (min)	
Zapiekanka ziemniaczana, 1,1 kg	300	niska	30 - 35	-
Kurczak, 1,1 kg	300	wysoka	30 - 35	Włożyć mięso do okrągłego szklanego naczynia.

11. KONSERWACJA I CZYSZCZENIE



OSTRZEŻENIE!

Patrz rozdział dotyczący bezpieczeństwa.

11.1 Uwagi dotyczące czyszczenia



Środki czyszczące

Umyć przód piekarnika miękką ściereczką zwilżoną ciepłą wodą z dodatkiem łagodnego detergentu.

Użyć roztworu czyszczącego, aby wyczyścić metalowe powierzchnie.

Usunąć plamy za pomocą łagodnego detergentu.



Codziennie użytkowanie

Czyścić komorę po każdym użyciu. Nagromadzenie się tłuszczu lub innych zabrudzeń może skutkować pożarem. Ostrożnie oczyścić górną ściankę piekarnika z zabrudzeń i tłuszczu.



Nie pozostawiać gotowych potraw w piekarniku na dłużej niż 20 minut. Po każdym użyciu osuszyć komorę miękką ściereczką.



	<p>Po każdym użyciu akcesoriów należy wyczyścić je i pozostawić do wyschnięcia. Przed przystąpieniem do czyszczenia należy poczekać, aż talerz obrotowy osygnie. W przeciwnym razie może dojść do pęknięcia talerza obrotowego. Do czyszczenia należy użyć miękkiej ściereczki zwilżonej ciepłą wodą z dodatkiem łagodnego detergentu. Nie myć akcesoriów w zmywarce.</p>
	<p>Do czyszczenia akcesoriów z powłoką zapobiegającą przywieraniu nie należy używać ściernych środków czyszczących ani przedmiotów o ostrych krawędziach.</p>

12. ROZWIĄZYWANIE PROBLEMÓW

	<p>OSTRZEŻENIE! Patrz rozdział dotyczący bezpieczeństwa.</p>
--	---



12.1 Co zrobić, gdy...

 Piekarnik nie włącza się lub nie nagrzewa się	
 Możliwa przyczyna	 Środek zaradczy
Piekarnika nie podłączono do zasilania lub podłączono nieprawidłowo.	Sprawdzić, czy piekarnik podłączono prawidłowo do zasilania.
Nie ustawiono aktualnego czasu.	Ustawić aktualny czas. Szczegółowe informacje znajdują się w rozdziale „Funkcje zegara”. Jak ustawić: Funkcje zegara.
Drzwi nie są prawidłowo zamknięte.	Domknąć drzwi.
Zadziałał bezpiecznik.	Sprawdzić, czy problem nie jest związany z bezpiecznikiem. Jeśli problem wystąpi ponownie, należy skontaktować się z wykwalifikowanym elektrykiem.
Włączona jest blokada uruchomienia piekarnika.	Patrz rozdział „Menu”, podmenu opcji: Opcje.

 Podzespoły	
 Opis	 Środek zaradczy
Żarówka oświetlenia jest przepalona.	Wymienić żarówkę oświetlenia; szczegółowe informacje znajdują się w rozdziale „Konserwacja i czyszczenie”, Sposób wymiany: Lampa.
Talerz obrotowy hałasuje.	Pod talerzem obrotowym znajdują się resztki jedzenia.

12.2 Jak postępować: Kody błędów

Gdy wystąpi błąd oprogramowania, na wyświetlaczu pojawia się komunikat o błędzie. W poniższej tabeli przedstawiono problemy, które użytkownik może rozwiązać samodzielnie.

 Kod i opis	 Środek zaradczy
F240, F439 – pola dotykowe na wyświetlaczu nie działają prawidłowo.	Wyczyścić powierzchnię wyświetlacza. Upewnić się, że na polach dotykowych nie ma zabrudzeń.
F908 – układ elektroniczny piekarnika nie może nawiązać połączenia z panelem sterowania.	Wyłączyć i ponownie włączyć piekarnik.

12.3 Dane serwisowe

Jeżeli rozwiązanie problemu we własnym zakresie nie jest możliwe, należy skontaktować się ze sprzedawcą lub z autoryzowanym punktem serwisowym.

Dane niezbędne dla serwisu znajdują się na tabliczce znamionowej. Tabliczka znamionowa znajduje się na przednim obramowaniu komory piekarnika. Nie usuwać tabliczki znamionowej z komory piekarnika.

Zalecamy zapisanie w tym miejscu danych:	
Model (MOD.)
Numer produktu (PNC)
Numer seryjny (S.N.)

13. EFEKTYWNOŚĆ ENERGETYCZNA

13.1 Oszczędzanie energii



Piekarnik wyposażono w funkcje umożliwiające oszczędzanie energii podczas codziennego pieczenia.

Podczas działania piekarnika sprawdzić, czy jego drzwi są prawidłowo zamknięte. Nie otwierać zbyt często drzwi piekarnika podczas pieczenia. Dbać, aby uszczelka drzwi była czysta i prawidłowo umieszczona.

Gdy nie jest to konieczne, nie należy wstępnie nagrzewać piekarnika przed rozpoczęciem pieczenia.

Przygotowując kilka potraw, należy w miarę możliwości skracać przerwy między ich pieczeniem.

Pieczenie z wyłączonym oświetleniem

Wyłączyć oświetlenie podczas pieczenia. Oświetlenie należy włączać tylko wtedy, gdy jest potrzebne.

14. STRUKTURA MENU

14.1 Menu

Nacisnąć , aby otworzyć Menu.

Pozycja menu		Zastosowanie
Ulubione		Wyświetlenie listy ulubionych ustawień.
Opcje		Ustawianie konfiguracji piekarnika.
Ustawienia	Konfiguracja	Ustawianie konfiguracji piekarnika.
	Serwis	Wyświetlanie informacji o wersji oprogramowania i konfiguracji.

14.2 Podmenu: Opcje

Podmenu	Zastosowanie
Oświetlenie piekarnika	Włączanie i wyłączanie oświetlenia.

Podmenu	Zastosowanie
Blokada uruchomienia	Zapobiega przypadkowemu włączeniu piekarnika. Gdy ta opcja jest włączona, po włączeniu piekarnika na wyświetlaczu pojawia się wskazanie „Blokada uruchomienia”. Aby korzystać z piekarnika, należy wybrać litery kodu w kolejności alfabetycznej. Dostęp do timera, funkcji zdalnego sterowania i oświetlenia możliwy jest z włączoną opcją Blokada uruchomienia.
Wskazanie czasu	Włączanie i wyłączanie zegara.
Styl cyfrowy zegara	Zmiana formatu wyświetlanego wskazania czasu.

14.3 Podmenu: Konfiguracja

Podmenu	Opis
Język	Ustawia język piekarnika.
Jasność wyświetlacza	Ustawia jasność wyświetlacza.
Dźwięki przycisków	Włącza i wyłącza dźwięk pól dotykowych. Nie jest możliwe wyłączenie sygnalizacji dźwiękowej dla: ①.
Głośność sygnału	Ustawia głośność dźwięku przycisków i sygnałów.
Aktualna godzina	Ustawia aktualną godzinę i datę.

14.4 Podmenu opcji: Serwis

Podmenu	Opis
Tryb demonstracyjny	Kod włączenia/wyłączenia: 2468
Wersja oprogramowania	Informacje na temat wersji oprogramowania.
Zresetuj wszystkie ustawienia	Przywraca ustawienia fabryczne.

15. TO PROSTE!

Przed pierwszym użyciem należy ustawić:









Język	Jasność wyświetlacza	Dźwięki przycisków	Głośność sygnału	Aktualna godzina
-------	----------------------	--------------------	------------------	------------------

Zapoznać się z podstawowymi ikonami na panelu sterowania i wyświetlaczu:



 Włączone / Wyłączone	 Menu	 Ulubione	 Timer	START / STOP
---	---	---	--	--------------

Rozpoczęcie użytkowania piekarnika

Szybkie uruchomienie MW	Uruchomienie w dowolnej chwili funkcji kuchenki mikrofalowej z domyślnymi ustawieniami: 30 s / 1000 W	Nacisnąć: 
--------------------------------	---	---



			
grzanie/pieczenie 100 - 1000 W	pieczenie/przyrumianie intensywność: niska / wysoka	pieczenie/przyrumianie	podgrzewanie płynów 800 - 1000 W
			
odgrzewanie 300 - 700 W	rozmrzanie 100 - 200 W	roztapianie 100 - 400 W	przygotowanie popcornu 700 - 1000 W

Ustawienia kuchenki mikrofalowej		Wskazówki dotyczące korzystania z kuchenki mikrofalowej
Moc mikrofal:	Maksymalny czas:	Przykryć potrawę na czas gotowania lub odgrzewania. Obrócić lub zamieszać potrawę po upływie połowy czasu rozmrażania lub gotowania. Podczas podgrzewania płynów umieścić łyżkę w naczyniu. Umieścić potrawę w piekarniku bez opakowania (tylko w kuchenke mikrofalowej).
100–600 W	59 min	
> 600 W	7 min	

Rozpoczęcie pieczenia				
Krok 1	Krok 2	Krok 3	Krok 4	Krok 5
 — nacisnąć, aby włączyć piekarnik.	 ... — wybrać funkcję.	W - ustawić moc mikrofal.	OK — nacisnąć, aby potwierdzić.	START — nacisnąć, aby rozpocząć pieczenie.

Korzystanie z szybkich funkcji do ustawienia czasu pieczenia	
10% — wykończenie potrawy Funkcja 10% — wykończenie potrawy umożliwia wydłużenie czasu pieczenia, gdy do zakończenia pieczenia pozostało 10% ustawionego czasu.	Aby wydłużyć czas pieczenia, należy nacisnąć +1 min.

16. OCHRONA ŚRODOWISKA

Materiały oznaczone symbolem  należy poddać utylizacji. Opakowanie urządzenia włożyć do odpowiedniego pojemnika w celu przeprowadzenia recyklingu. Należy zadbać o ponowne przetwarzanie odpadów urządzeń elektrycznych i elektronicznych, aby chronić środowisko naturalne oraz ludzkie zdrowie. Nie wolno wyrzucać urządzeń oznaczonych symbolem  razem z odpadami domowymi. Należy zwrócić produkt do miejscowego punktu ponownego przetwarzania lub skontaktować się z odpowiednimi władzami miejskimi.

PARA RESULTADOS PERFEITOS

Obrigado por escolher este produto AEG. Criámo-lo para lhe proporcionar um desempenho impecável durante muitos anos, com tecnologias inovadoras que tornam a sua vida mais fácil – funcionalidades que poderá não encontrar em aparelhos comuns. Continue a ler durante alguns minutos para tirar o máximo partido do produto.

Visite o nosso website para:



Obter conselhos de utilização, folhetos, resolução de problemas e informações sobre assistência e reparações:

www.aeg.com/support



Registe o seu produto para beneficiar de um serviço melhor:

www.registeraeg.com



Adquira acessórios, consumíveis e peças de substituição originais para o seu aparelho:

www.aeg.com/shop

APOIO AO CLIENTE E ASSISTÊNCIA

Usar sempre peças sobressalentes de origem.

Sempre que contactar o nosso Centro de Assistência Técnica Autorizado, assegure que tem disponíveis os dados seguintes: Modelo, PNC, Número de série.

Esta informação encontra-se na placa de identificação.

 Aviso/Cuidado – Informações de segurança

 Informações gerais e sugestões

 Informações ambientais

Sujeito a alterações sem aviso prévio.

ÍNDICE

1. INFORMAÇÕES DE SEGURANÇA.....	301	3.2 Acessórios.....	308
1.1 Segurança de crianças e pessoas vulneráveis.....	301	4. COMO LIGAR E DESLIGAR O FORNO. 308	
1.2 Segurança geral.....	302	4.1 Painel de comandos.....	308
2. INSTRUÇÕES DE SEGURANÇA.....	304	4.2 Visor.....	310
2.1 Instalação.....	304	5. ANTES DA PRIMEIRA UTILIZAÇÃO.....	311
2.2 Ligação elétrica.....	305	5.1 Limpeza inicial.....	311
2.3 Utilização.....	306	5.2 Primeira ligação.....	311
2.4 Manutenção e limpeza.....	307	6. UTILIZAÇÃO DIÁRIA.....	311
2.5 Iluminação interna.....	307	6.1 Como seleccionar a função:	
2.6 Assistência técnica.....	307	Grelhador + MO, Grelhador.....	311
2.7 Eliminação.....	307	6.2 Como definir: Tipos de aquecimento do micro-ondas.....	313
3. DESCRIÇÃO DO PRODUTO.....	308		
3.1 Visão geral.....	308		

6.3 Como utilizar: Iniciar rápido do micro-ondas.....	314	10.5 Tabelas de cozedura para testes.....	322
6.4 Funções de aquecimento.....	314	11. MANUTENÇÃO E LIMPEZA.....	323
7. FUNÇÕES DE RELÓGIO.....	315	11.1 Notas sobre a limpeza.....	323
7.1 Descrição das funções do relógio.....	315	12. RESOLUÇÃO DE PROBLEMAS.....	324
7.2 Como definir: Funções do relógio.....	316	12.1 O que fazer se.....	324
8. COMO UTILIZAR: ACESSÓRIOS.....	317	12.2 Como gerir: Código de erro.....	325
8.1 Inserir acessórios.....	317	12.3 Dados de assistência técnica....	325
9. FUNÇÕES ADICIONAIS.....	317	13. EFICIÊNCIA ENERGÉTICA.....	326
9.1 Como guardar: Favoritos.....	317	13.1 Poupança de energia.....	326
9.2 Bloqueio de funções.....	318	14. ESTRUTURA DO MENU.....	326
9.3 Ventoinha de arrefecimento.....	318	14.1 Menu.....	326
10. SUGESTÕES E DICAS.....	319	14.2 Submenu para: Opções.....	326
10.1 Recomendações para cozinhar.....	319	14.3 Submenu para: Configuração....	327
10.2 Recomendações para o microondas	319	14.4 Submenu para: Assistência Técnica.....	327
10.3 Recipientes e materiais adequados para micro-ondas	320	15. É FÁCIL!.....	328
10.4 Definições de potência recomendadas para diversos tipos de alimentos.....	321	16. PREOCUPAÇÕES AMBIENTAIS.....	329

1. INFORMAÇÕES DE SEGURANÇA

Leia atentamente as instruções fornecidas antes de instalar e utilizar o aparelho. O fabricante não é responsável por quaisquer ferimentos ou danos resultantes de instalação ou utilização incorretas. Guarde sempre as instruções em local seguro e acessível para consultar no futuro.

1.1 Segurança de crianças e pessoas vulneráveis

- Este aparelho pode ser utilizado por crianças com 8 anos de idade ou mais velhas e por pessoas com capacidades físicas, sensoriais ou mentais reduzidas ou falta de experiência e conhecimento se forem supervisionadas ou instruídas no que respeita à utilização do aparelho de uma forma segura e compreenderem os perigos envolvidos. É necessário manter as crianças com menos de 8 anos de idade e pessoas com incapacidades muito extensas e

complexas afastadas do aparelho, a menos que sejam constantemente vigiadas.

- As crianças devem ser vigiadas para garantir que não brincam com o aparelho.
- Mantenha todos os materiais de embalagem fora do alcance das crianças e elimine-os de forma apropriada.
- AVISO: Mantenha as crianças e os animais domésticos afastados do forno quando este estiver a funcionar ou a arrefecer. As partes acessíveis ficam quentes durante a utilização.
- Se o aparelho tiver um dispositivo de segurança para crianças, recomendamos que o ative.
- A limpeza e a manutenção básica do aparelho não devem ser efetuadas por crianças sem supervisão.

1.2 Segurança geral

- Este aparelho destina-se apenas a ser utilizado para cozinhar.
- Este aparelho foi concebido unicamente para utilização doméstica num ambiente interior.
- Este aparelho pode ser utilizado em escritórios, quartos de hóspedes de hotéis, quartos de hóspedes de pousadas, casas de hóspedes de turismo rural e outros alojamentos semelhantes onde tal utilização não exceda os níveis de utilização doméstica (médios).
- Apenas uma pessoa qualificada pode instalar este aparelho e substituir o cabo.
- Não use o aparelho antes de instalá-lo na estrutura embutida.
- Desligue o aparelho da fonte de alimentação antes de realizar qualquer manutenção.
- Se o cabo de alimentação elétrica estiver danificado, deve ser substituído pelo fabricante, por um Centro de Assistência Técnica Autorizado ou por uma pessoa igualmente qualificada, para evitar perigos elétricos.

- AVISO: Certifique-se de que o aparelho está desligado antes de substituir a lâmpada, para evitar a possibilidade de choque elétrico.
- AVISO: O forno e as partes acessíveis ficam quentes durante a utilização. Deve ter cuidado para evitar tocar nas resistências de aquecimento.
- Utilize sempre luvas de forno para retirar ou inserir acessórios ou recipientes de ir ao forno.
- Utilize apenas o prato rotativo e o seu suporte concebidos para este aparelho.
- Não ative a função de microondas quando o aparelho estiver vazio. As peças metálicas no interior da cavidade podem criar arco eléctrico.
- Não é permitido utilizar recipientes metálicos de alimentos ou bebidas para cozinhar com micro-ondas. Esta restrição não se aplica se o fabricante especificar o tamanho e a forma dos recipientes metálicos que podem ser utilizados para cozinhar com micro-ondas.
- AVISO: Em caso de danos na porta ou nos vedantes da porta, não utilize o aparelho até que tenha sido reparado por uma pessoa qualificada.
- AVISO: Apenas uma pessoa qualificada pode efetuar ações de manutenção e reparação que envolvam a remoção da cobertura que protege contra a exposição à energia de microondas.
- AVISO: Não aqueça líquidos e outros alimentos em recipientes selados. Podem explodir.
- Utilize apenas utensílios adequados para utilizar em fornos microondas.
- Quando aquecer alimentos em recipientes de plástico ou papel, vigie o aparelho, porque existe o risco de ignição.
- O aparelho destina-se a aquecer alimentos e bebidas. A secagem de alimentos ou vestuário e o aquecimento de almofadas de aquecimento, chinelos, esponjas, panos

INSTRUÇÕES DE SEGURANÇA

tecidos húmidos e outros semelhantes podem resultar em risco de ferimentos, ignição e incêndio.

- Se observar fumo, desligue o aparelho ou retire a ficha da tomada e mantenha a porta fechada para abafar possíveis chamas.
- O aquecimento de bebidas no microondas pode provocar ebulição eruptiva retardada. Tenha cuidado ao manusear o recipiente.
- O conteúdo de biberões e de boiões de comida para bebé deve ser agitado e mexido e a temperatura deve ser verificada antes do consumo, para evitar queimaduras.
- Os ovos inteiros e os ovos cozidos inteiros não devem ser aquecidos no aparelho, porque podem explodir, mesmo depois de ter terminado o aquecimento no microondas.
- O aparelho deve ser limpo regularmente e os depósitos de alimentos devem ser removidos.
- Não utilize um aparelho de limpeza a vapor para limpar o aparelho.
- Não utilize agentes de limpeza abrasivos ou raspadores metálicos afiados para limpar a porta de vidro, porque podem riscar a superfície e quebrar o vidro.
- Se não mantiver o aparelho limpo, a superfície pode deteriorar-se e isso pode afetar negativamente a vida útil do aparelho e resultar numa situação perigosa.

2. INSTRUÇÕES DE SEGURANÇA

2.1 Instalação



AVISO!

A instalação deste aparelho tem de ser efetuada por uma pessoa qualificada.

- Retire a embalagem toda.
- Não instale nem utilize o aparelho se estiver danificado.
- Siga as instruções de instalação fornecidas com o aparelho.
- Tenha sempre cuidado quando deslocar o aparelho porque ele é pesado. Utilize sempre luvas de proteção e calçado fechado.
- Não puxe o aparelho pela pega.
- Instale o aparelho num local seguro e adequado que cumpra com os requisitos da instalação.

INSTRUÇÕES DE SEGURANÇA

- Respeite as distâncias mínimas relativamente a outros aparelhos e unidades.
- Antes de montar o aparelho, verifique se a porta do forno abre sem limitações.
- O aparelho está equipado com um sistema de arrefecimento elétrico. É necessário utilizar a alimentação elétrica.
- A unidade de encastrar tem de cumprir os requisitos de estabilidade da norma DIN 68930.

Altura mínima do armário (altura mínima do armário debaixo do balcão)	444 (460) mm
Largura do armário	560 mm
Profundidade do armário	550 (550) mm
Altura da parte da frente do aparelho	455 mm
Altura da parte de trás do aparelho	440 mm
Largura da parte da frente do aparelho	595 mm
Largura da parte de trás do aparelho	559 mm
Profundidade do aparelho	567 mm
Profundidade de encastre do aparelho	546 mm
Profundidade com a porta aberta	882 mm
Dimensão mínima da abertura de ventilação. Abertura localizada na parte inferior traseira	560x20 mm
Comprimento do cabo de alimentação elétrica. O cabo sai pelo canto traseiro direito	1500 mm
Parafusos de montagem	3.5x25 mm

2.2 Ligação elétrica



AVISO!

Risco de incêndio e choque elétrico.

- Todas as ligações elétricas devem ser efectuadas por um electricista qualificado.
- O aparelho tem de ficar ligado à terra.
- Certifique-se de que os parâmetros indicados na placa de características são compatíveis com as características da alimentação elétrica.
- Utilize sempre uma tomada devidamente instalada e à prova de choques elétricos.
- Não utilize adaptadores de tomadas duplas ou triplas, nem cabos de extensão.

INSTRUÇÕES DE SEGURANÇA

- Certifique-se de que não danifica a ficha e o cabo de alimentação eléctrica. Se for necessário substituir o cabo de alimentação, esta operação deve ser efectuada pelo nosso Centro de Assistência Técnica.
- Não permita que algum cabo eléctrico toque na porta do aparelho ou no nicho abaixo do aparelho, especialmente quando a porta estiver quente.
- As protecções contra choques eléctricos das peças isoladas e não isoladas devem estar fixas de modo a não poderem ser retiradas sem ferramentas.
- Ligue a ficha à tomada eléctrica apenas no final da instalação. Certifique-se de que a ficha fica acessível após a instalação.
- Se a tomada eléctrica estiver solta, não ligue a ficha.
- Não puxe o cabo de alimentação para desligar o aparelho. Puxe sempre a ficha.
- disjuntores de protecção, fusíveis (os fusíveis de rosca devem ser retirados do suporte), diferenciais e contactores.
- A instalação eléctrica deve possuir um dispositivo de isolamento que lhe permita desligar o aparelho da corrente eléctrica em todos os pólos. O dispositivo de isolamento deve ter uma abertura de contacto com uma largura mínima de 3 mm.
- Este aparelho é fornecido com ficha e cabo de alimentação.

2.3 Utilização



AVISO!

Risco de ferimentos, queimaduras, choque eléctrico ou explosão.

- Não altere as especificações deste aparelho.
- Certifique-se de que as aberturas de ventilação não ficam obstruídas.
- Não deixe o aparelho sem vigilância durante o funcionamento.
- Desative o aparelho após cada utilização.
- Tenha cuidado quando abrir a porta do aparelho com o aparelho em funcionamento. Pode sair ar quente.
- Não utilize o aparelho com as mãos molhadas ou quando ele estiver em contacto com água.
- Não aplique pressão sobre a porta aberta.
- Não utilize o aparelho como superfície de trabalho ou armazenamento.
- Abra a porta do aparelho com cuidado. A utilização de ingredientes com álcool pode provocar uma mistura de álcool e ar.
- Evite que faíscas ou chamas entrem em contacto com o aparelho quando abrir a porta.
- Não coloque produtos inflamáveis, nem objetos molhados com produtos inflamáveis, no interior, perto ou em cima do aparelho.
- Não utilize a função de micro-ondas para pré-aquecer o forno.



AVISO!

Risco de danos no aparelho.

- Para evitar danos ou descoloração no esmalte:
 - não coloque folha de alumínio diretamente sobre o fundo da cavidade do aparelho.
 - não coloque água diretamente no aparelho quente.
 - não mantenha pratos e alimentos húmidos no aparelho após acabar de cozinhar.
 - tenha cuidado quando remover ou montar os acessórios.
- A eventual descoloração do esmalte ou do aço inoxidável não afeta o desempenho do aparelho.
- Cozinhe sempre com a porta do aparelho fechada.

- Se o aparelho ficar instalado atrás de uma porta de armário, nunca feche a porta com o aparelho em funcionamento. Se a porta ficar fechada, poderá ocorrer acumulação de calor e humidade que podem danificar o aparelho, os móveis ou o piso. Não feche a porta do armário enquanto o aparelho não tiver arrefecido completamente após utilização.

2.4 Manutenção e limpeza



AVISO!

Risco de ferimentos, incêndio e danos no aparelho.

- Antes de qualquer ação de manutenção, desative o aparelho e desligue a ficha da tomada elétrica.
- Certifique-se de que o aparelho está frio. Existe o risco de quebra dos painéis de vidro.
- Substitua imediatamente os painéis de vidro se estiverem danificados. Contacte um Centro de Assistência Técnica Autorizado.
- Tenha cuidado quando remover a porta do aparelho. A porta é pesada!
- Não se esqueça de limpar e secar bem a cavidade, o prato rotativo e a porta após cada utilização. O vapor produzido durante o funcionamento do aparelho condensa nas paredes da cavidade e pode causar corrosão.
- Limpe o aparelho com regularidade para evitar que o material da superfície se deteriore.
- Quaisquer restos de gordura ou alimentos que fiquem no aparelho podem provocar incêndio e arco elétrico quando o micro-ondas estiver a funcionar.
- Limpe o aparelho com um pano macio e húmido. Utilize apenas detergentes neutros. Não utilize produtos abrasivos, esfregões, solventes ou objetos metálicos.
- Se utilizar um spray para forno, siga as instruções de segurança da embalagem.

2.5 Iluminação interna



AVISO!

Risco de choque elétrico.

- Relativamente à(s) lâmpada(s) no interior deste produto e às lâmpadas sobressalentes vendidas separadamente: Estas lâmpadas destinam-se a suportar condições físicas extremas em eletrodomésticos, tais como temperatura, vibração, humidade, ou destinam-se a sinalizar informação relativamente ao estado operacional do aparelho. Não se destinam a ser utilizadas em outras aplicações e não se adequam à iluminação de espaços domésticos.
- Este produto contém uma fonte de luz da classe de eficiência energética G.
- Utilize apenas lâmpadas com as mesmas especificações.

2.6 Assistência técnica

- Para reparar o aparelho, contacte o Centro de Assistência Técnica Autorizado.
- Utilize apenas peças sobressalentes originais.

2.7 Eliminação



AVISO!

Risco de ferimentos ou asfixia.

- Contacte a sua autoridade municipal para saber como descartar o aparelho corretamente.
- Desligue o aparelho da alimentação elétrica.
- Corte o cabo de alimentação elétrica do aparelho e elimine-o.

DESCRIÇÃO DO PRODUTO

- Remova o trinco da porta para evitar que crianças ou animais de estimação fiquem presos no aparelho.

3. DESCRIÇÃO DO PRODUTO

3.1 Visão geral

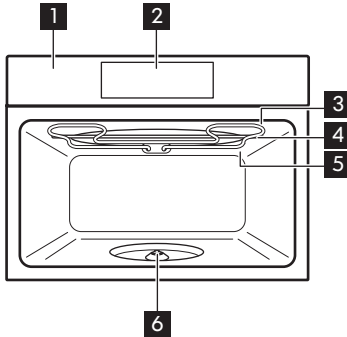

- 1 Painel de comandos
- 2 Visor
- 3 Elemento de aquecimento
- 4 Gerador de micro-ondas
- 5 Lâmpada
- 6 Eixo do prato rotativo

3.2 Acessórios

Conjunto do prato rotativo
Para preparar alimentos.

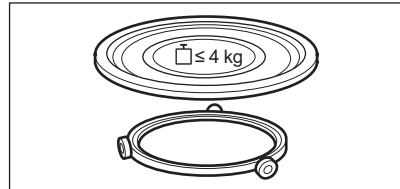

Conjunto de prateleira para o grelhador
Para grelhar.

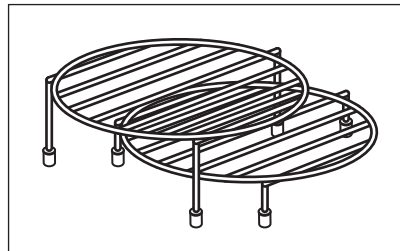

4. COMO LIGAR E DESLIGAR O FORNO

4.1 Painel de comandos

COMO LIGAR E DESLIGAR O FORNO

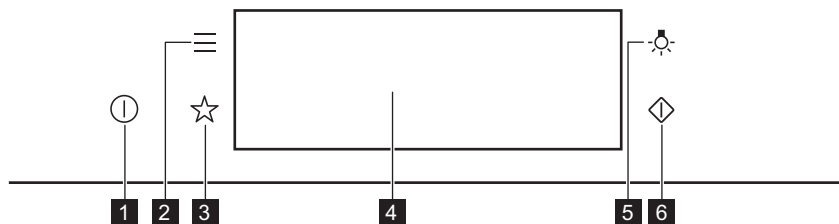



1	On / Off	Mantenha premido para ativar e desativar o forno.
2	Menu	Lista as funções do forno.
3	Favoritos	Lista as definições favoritas.
4	Visor	Apresenta as definições atuais do forno.
5	Interruptor da lâmpada	Para acender e apagar a lâmpada.
6	Iniciar rápido do micro-ondas	Para ativar a função micro-ondas (1000 W e 30 segundos).

 Prima	 Deslocar	 Prima e segure continuamente
Toque na superfície com a ponta do dedo.	Faça deslizar a ponta do dedo sobre a superfície.	Toque na superfície durante 3 segundos.



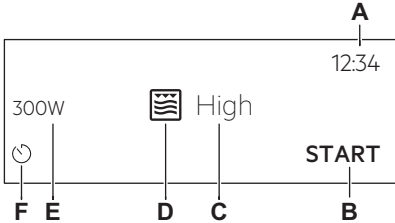
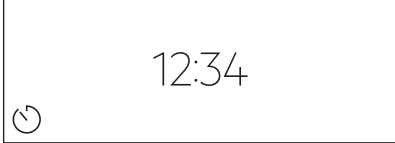

COMO LIGAR E DESLIGAR O FORNO

4.2 Visor



 <p>Diagrama do visor principal com a seguinte informação: 300W, ícone de grelhador, High, 12:34, START. Botões rotulados: A (12:34), B (START), C (High), D (ícone de grelhador), E (300W), F (ícone de relógio).</p>	<p>Após ligar, o visor apresenta o ecrã principal com a função e a intensidade predefinida do grelhador.</p> <ul style="list-style-type: none">A. HoraB. INICIAR/PARARC. Intensidade do grelhadorD. Tipos de aquecimentoE. Potência do micro-ondasF. Temporizador
 <p>Visor mostrando a hora 12:34 e ícone de relógio.</p>	<p>Se não utilizar o forno durante 2 minutos, o visor entra em espera.</p>
 <p>Visor mostrando 1000W, ícone de grelhador, 1m23s, +30s e STOP.</p>	<p>Quando cozinhar, o visor apresenta as definições das funções e outras opções disponíveis.</p>

Indicadores do visor

Indicadores básicos – para navegar no visor.

 <p>Para confirmar a seleção/definições.</p>	 <p>Para voltar um nível no menu.</p>	 <p>Para desfazer a última ação.</p>	 <p>Para ativar e desativar as opções.</p>
---	--	---	---

Alarme sonoro Indicadores de função – quando o tempo de confeção definido termina, é emitido um sinal sonoro.

 <p>A função está ativada.</p>	 <p>A função está ativada. O cozinhar para automaticamente.</p>	 <p>O alarme sonoro está desativado.</p>
---	--	---

Indicadores do temporizador

ANTES DA PRIMEIRA UTILIZAÇÃO



Para as definições da função: Início programado.



Para cancelar as definições.

5. ANTES DA PRIMEIRA UTILIZAÇÃO



AVISO!

Consulte os capítulos relativos à segurança.

5.1 Limpeza inicial

Passo 1	Passo 2	Passo 3
Remova todos os acessórios do forno.	Limpe o forno e os acessórios com um pano macio, água morna e um detergente suave.	Coloque os acessórios no forno.

5.2 Primeira ligação

O visor exibe a mensagem de boas-vindas depois da primeira ligação. É preciso definir: Idioma, Brilho do visor, Sons “teclado”, Volume do alarme, Hora.

6. UTILIZAÇÃO DIÁRIA



AVISO!

Consulte os capítulos relativos à segurança.

6.1 Como seleccionar a função: Grelhador + MO, Grelhador

O forno pode emitir ruídos ao utilizar a função: Grelhador + MO. São normais para esta função.

Configurar a função: Grelhador + MO	
Passo 1	Introduza a prateleira do grelhador baixa.
Passo 2	Ligue o forno. O visor mostra as funções de aquecimento padrão
Passo 3	Prima o símbolo da função de aquecimento para entrar no submenu.

UTILIZAÇÃO DIÁRIA

Configurar a função: Grelhador + MO	
Passo 4	Selecione a função:  . Prima: OK.
Passo 5	Selecione o nível de intensidade do grelhador.
Função	Nível de intensidade do grelhador
Lo	Baixo
Hi	Alto
Passo 6	Premir: OK.
Passo 7	Prima: START .
STOP - prima para desligar o forno.	
Passo 8	Desligue o forno.

A potência do micro-ondas está limitada a 500 W quando utiliza a função: Grelhador + MO.

Configurar a função: Grelhador	
Passo 1	Introduza a prateleira do grelhador elevada.
Passo 2	Ligue o forno. O visor mostra as funções de aquecimento padrão
Passo 3	Prima o símbolo da função de aquecimento para entrar no submenu.
Passo 4	Selecione a função:  . Prima: OK.
Passo 5	Selecione o nível de intensidade do grelhador.
Função	Nível de intensidade do grelhador
Lo	Baixo
Hi	Alto
Passo 6	Premir: OK.

Configurar a função: Grelhador	
Passo 7	Prima: START .
STOP - prima para desactivar a função.	
Passo 8	Desligue o forno.

6.2 Como definir: Tipos de aquecimento do micro-ondas

Passo 1	Ligue o forno.
Passo 2	Prima o símbolo da função de aquecimento para entrar no submenu.
Passo 3	Selecione a função de aquecimento do microondas e prima: OK. O visor mostra: potência do micro-ondas.
Passo 4	Definir: potência do microondas. Premir: OK.
Passo 5	Prima: START .
STOP - prima para desativar a função.	
Passo 6	Desligue o forno.

O tempo máximo das funções do micro-ondas depende da potência que definiu para o micro-ondas:

POTÊNCIA DO MICRO-ONDAS	TEMPO MÁXIMO
100 - 600 W	59 minutos
Superior a 600 W	7 minutos



Se abrir a porta, a função para. Para iniciar novamente, prima START .

Utilize um atalho!



6.3 Como utilizar: Iniciar rápido do micro-ondas





Passo 1	Prima continuamente: . O micro-ondas funciona durante 30 seg.	
Passo 2	Para prolongar o tempo da cozedura.	
	Prima no valor de tempo em execução para ir para as definições de tempo. Defina o tempo da cozedura.	Prima +30 s.
O micro-ondas pode ser ligado a qualquer momento com: Iniciar rápido do micro-ondas.		

6.4 Funções de aquecimento

NORMAL

Tipo de aquecimento	Aplicação
 Grelhador	Para grelhar alimentos finos e tostar pão.
 Grelhador + MO	Para cozinhar alimentos em pouco tempo e tostá-los. Pode definir 2 níveis de intensidade do grelhador: baixo e alto.
 Micro-ondas	Aquecer, cozinhar, intervalo de potência: 100 - 1000 W

MICRO-ONDAS

Tipo de aquecimento	Aplicação
 Descongelar	Descongelar carne, peixe, bolos, gama de potência: 100 - 200 W
 Derreter	Derreter chocolate e manteiga, intervalo de potência: 100 - 400 W
 Reaquecer	Aquecer refeições pré-cozinhadas e alimentos delicados, intervalo de potência: 300 - 700 W
 Pipocas	Preparar pipocas, gama de potência: 700 - 1000 W
 Líquido	Aquecer bebidas e sopas, intervalo de potência: 800 - 1000 W

7. FUNÇÕES DE RELÓGIO

7.1 Descrição das funções do relógio

Funções do relógio	Aplicação
Tempo para cozinhar	Para definir a duração da cozedura. O máximo é de 23 h 59 min.
Finalizar ação	Para definir o que acontece quando o temporizador termina a contagem.
Prolongar tempo	Para prolongar o tempo de cozedura.
Aviso	Para definir uma contagem decrescente. O máximo é de 23 h 59 min. Esta função não afeta o funcionamento do forno.
Temporizador crescente	Monitoriza o tempo de atividade da função. Temporizador crescente – pode ligar ou desligar.

7.2 Como definir: Funções do relógio

Como acertar o relógio	
Passo 1	Premir: Hora.
Passo 2	Acertar as horas. Premir: OK.

Como definir o tempo de cozedura	
Passo 1	Escolha o tipo de aquecimento.
Passo 2	Prima:  .
Passo 3	Acertar as horas. Premir: OK.

Como escolher a opção final	
Passo 1	Escolha o tipo de aquecimento.
Passo 2	Prima:  .
Passo 3	Defina o tempo da cozedura.
Passo 4	Premir: ● ● ● .
Passo 5	Prima: Finalizar ação.
Passo 6	Escolha o preferido: Finalizar ação.
Passo 7	Premir: OK. Repita a ação até o visor apresentar o ecrã principal.

Como prolongar o tempo de cozedura	
Quando faltar 10% do tempo de cozedura e os alimentos parecerem não estar prontos, pode prolongar o tempo de cozedura. Pode também mudar a função de aquecimento.	
Para prolongar o tempo de cozedura prima +1min .	

Como alterar as definições do temporizador

Passo 1 Premir: 

Passo 2 Defina o valor do temporizador.

Passo 3 Premir: OK.

Pode alterar o tempo definido durante o cozinhado a qualquer momento.

8. COMO UTILIZAR: ACESSÓRIOS

8.1 Inserir acessórios

Utilize apenas materiais e recipientes adequados. Consulte “Recipientes e materiais adequados para micro-ondas” no capítulo “Sugestões e dicas”.

Conjunto do prato rotativo:

Cozinhe sempre os alimentos no conjunto do prato rotativo.

Coloque a guia com roletes à volta do eixo do prato rotativo. Coloque o prato rotativo de vidro sobre a guia com roletes.

Utilize apenas o conjunto do prato rotativo fornecido com o forno.

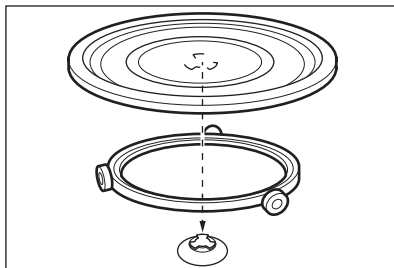

Conjunto de prateleira para o grelhador:

Coloque a prateleira do grelhador com as bases de silicone voltadas para baixo no conjunto do prato rotativo.

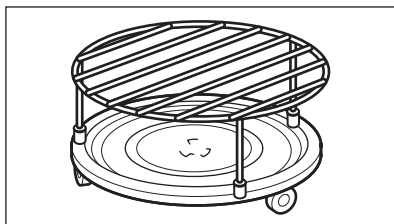

9. FUNÇÕES ADICIONAIS

9.1 Como guardar: Favoritos



Pode guardar as suas definições favoritas, como a função de aquecimento, o tempo de confeção ou a função de limpeza. Pode guardar 3 definições favoritas.

FUNÇÕES ADICIONAIS

Passo 1	Ligar o forno.
Passo 2	Selecione a definição preferida.
Passo 3	Premir:  Selecione: Favoritos.
Passo 4	Selecione: Guardar as definições atuais.
Passo 5	Prima + para adicionar a definição à lista de: Favoritos. Prima OK.
↶ – prima para repor a definição. ⊗ – prima para cancelar a definição.	

9.2 Bloqueio de funções

Esta função evita uma alteração acidental do tipo de aquecimento.

Passo 1	Ligar o forno.
Passo 2	Definir uma função de aquecimento.
Passo 3	 ,  - prima em simultâneo para ligar a função.
Para desligar a função, repita o passo 3.	

9.3 Ventoinha de arrefecimento

Quando o forno está a funcionar, a ventoinha de arrefecimento é ativada automaticamente para manter as superfícies do forno frias. Se desligar o forno, a ventoinha de arrefecimento pode continuar a funcionar até o forno arrefecer.

10. SUGESTÕES E DICAS

10.1 Recomendações para cozinhar



A temperatura e os tempos de cozedura indicados nas tabelas são apenas valores de referência. Dependem das receitas e da qualidade e quantidade dos ingredientes utilizados.

O seu forno pode cozer de um modo diferente do forno que utilizava anteriormente. As sugestões abaixo exibem os tipos de aquecimento e as definições recomendadas para tempo de cozedura para tipos específicos de alimentos.

Se não encontrar as regulações para alguma receita específica, procure uma semelhante.

Para mais recomendações de cozedura, consulte as tabelas de cozedura no nosso site. Para encontrar as Sugestões de cozedura, anote o número PNC que se encontra na placa de características da moldura frontal da cavidade do forno.

10.2 Recomendações para o microondas

Vamos cozinhar!

Não coloque os alimentos diretamente no prato rotativo. Utilize sempre recipientes apropriados para microondas.

Coloque o recipiente no meio do prato rotativo.

O contacto com artigos demasiado quentes ou frios pode partir o prato rotativo.

Vire ou mexa os alimentos a meio do tempo de descongelação ou cozedura.

Mexa os preparados líquidos regularmente.

Mexa os alimentos antes de os servir.

Cubra os alimentos quando cozinhar e reaquecer.

Quando aquecer líquidos em frasco ou copo, mexa o conteúdo com uma colher para distribuir melhor o calor.

Coloque os alimentos no forno sem as embalagens. As refeições prontas embaladas podem ser colocadas no forno se as embalagens forem próprias para microondas (consulte as indicações na embalagem).



Cozinhar no microondas

Cozinhe os alimentos com tampa. Se desejar obter uma crosta, cozinhe os alimentos sem tampa.

Não cozinhar demasiado os pratos, regulando a potência e o tempo para um valor demasiado elevado. Os alimentos podem secar, queimar ou incendiar-se.

Não utilize o forno para cozer ovos com casca e caracóis porque podem explodir. Perfure as gemas dos ovos estrelados antes de os reaquecer.

Perfure várias vezes os alimentos que tenham casca ou pele antes de os cozinhar.

Corte os legumes em pedaços com tamanhos semelhantes.

Depois de desligar o forno, retirar os alimentos e deixá-los repousar durante alguns minutos para permitir que o calor seja uniformemente distribuído.



Descongelação no microondas

Coloque os alimentos congelados e sem embalagem sobre um prato pequeno virado ao contrário, ou sobre uma peneira de plástico ou um tabuleiro de descongelação, para que o líquido da descongelação possa derramar.

SUGESTÕES E DICAS





Remova os pedaços à medida que foram ficando descongelados.





Para cozinhar fruta e legumes sem os descongelar antes, pode utilizar uma potência do microondas maior.

10.3 Recipientes e materiais adequados para micro-ondas

Utilize apenas materiais e recipientes adequados para micro-ondas quando utilizar a função de micro-ondas. Utilize a tabela em baixo como referência.



Verifique as especificações do recipiente/material antes da utilização.







Recipiente/Material				
Porcelana e vidro próprios para forno, sem componentes metálicos, por exemplo, vidro à prova de calor	✓	✓	✓	✓
Vidro e porcelana não adequados para forno, sem decorações em prata, ouro, platina ou outro metal	✓	X	X	X
Vidro e vitrocerâmica fabricados em material adequado para forno/congelador	✓	✓	✓	✓
Cerâmica e barro sem componentes de quartzo ou metal, nem revestimentos que contenham metal	✓	✓	X	X
Cerâmica, porcelana ou barro com fundo não vidrado ou pequenos orifícios, por exemplo, nas pegas	X	X	X	X
Plástico resistente ao calor até 200 °C	✓	✓	X	X
Cartão, papel	✓	X	X	X
Película aderente	✓	X	X	X

Recipiente/Material				
Película própria para assados com fecho seguro para micro-ondas	✓	✓	X	X
Assadeiras em metal, por exemplo, esmalte, ferro fundido	X	X	✓	X
Formas para assar, com revestimento de silicone ou laca preta	X	X	✓	X
Recipientes para utilizar em micro-ondas, por exemplo, uma frigideira de pega amovível	X	✓	X	X
Conjunto de prateleiras para o grelhador	X	X	✓	✓



10.4 Definições de potência recomendadas para diversos tipos de alimentos





Os dados apresentados na tabela servem apenas como referência.

800 – 1000 W	
 Ferver no início do processo de confeitão	 Aquecer líquidos

500 – 700 W					
 Cozinhar legumes	 Confecionar pratos com ovos	 Lume brando para estufados	 Cozer arroz em lume brando	 Aquecer pratos individuais	 Descongelar e aquecer refeições congeladas

SUGESTÕES E DICAS





300 – 400 W		
 Derreter queijo, chocolate ou manteiga	 Cozinhar / Aquecer alimentos delicados	 Continuar a cozinhar

100 - 200 W				
 Aquecer comida de bebé	 Descongelar pão	 Descongelar fruta e bolos	 Descongelar queijo, natas, manteiga	 Descongelar carne ou peixe





10.5 Tabelas de cozedura para testes

Informação para institutos de teste

Testes de acordo com a norma IEC 60705.

FUNÇÃO DE MICRO-ONDAS	 POWER (W)	 (kg)		 (min.)	
Pão-de-ló	600	0.475	Conjunto de prato rotativo	5 - 7	-
Rolo de carne	500	0.9	Conjunto de prato rotativo	18 - 20	-
Prato de ovos no forno	500	1	Conjunto de prato rotativo	15 - 17	-
Descongelar carne	200	0.5	Conjunto de prato rotativo	8 - 9	-

Usar a função: Micro-ondas + Grelhador.
Utilize a prateleira do grelhador baixa.

FUNÇÃO COMBINADA COM MICRO-ONDAS	 POWER (W)	 Nível de intensidade do grelhador	 (min.)	
Batatas gratinadas, 1,1 kg	300	baixo	30 - 35	-
Frango, 1,1 kg	300	alto	30 - 35	Coloque a carne num recipiente de vidro redondo.



11. MANUTENÇÃO E LIMPEZA



AVISO!

Consulte os capítulos relativos à segurança.

11.1 Notas sobre a limpeza

 Agentes de limpeza	Limpe a parte da frente do forno com um pano macio com água morna e um detergente suave.
	Utilize uma solução de limpeza para limpar as superfícies metálicas.
	Limpe manchas com um detergente suave.
 Utilização diária	Limpe a cavidade após cada utilização. A acumulação de gordura ou outros resíduos pode provocar incêndios. Limpe cuidadosamente resíduos e gordura da parte superior do forno.
	Não guarde alimentos no forno durante mais de 20 minutos. Seque a cavidade com um pano macio após cada utilização.

RESOLUÇÃO DE PROBLEMAS



Acessórios

Limpe todos os acessórios do forno após cada utilização e deixe-os secar. Antes de limpar, aguarde até que o prato rotativo esteja frio. Existe o risco de quebra do prato rotativo. Utilize um pano macio com água morna e um detergente suave. Não lave os acessórios na máquina de lavar loiça

Não limpe acessórios anti-aderentes utilizando detergentes abrasivos ou objetos afiados.

12. RESOLUÇÃO DE PROBLEMAS



AVISO!

Consulte os capítulos relativos à segurança.

12.1 O que fazer se...



O forno não liga ou não aquece



Causa possível



Solução

O forno não está ligado à corrente elétrica ou não está ligado corretamente.

Verifique se o forno está ligado corretamente à corrente elétrica.

O relógio não está acertado.

Acerte o relógio; para mais informações, consulte o capítulo “Funções de relógio”, Como acertar: Funções do relógio.

A porta não fecha bem.



Fechete a porta completamente.

O fusível está fundido.

Certifique-se de que é o fusível a causa do problema. Se o problema persistir, contacte um eletricitista qualificado.



O Bloqueio para Crianças do forno está ativado.

Consulte o capítulo “Menu”, Submenu para: Opções.

 Componentes	
 Descrição	 Solução
A lâmpada está fundida.	Substitua a lâmpada; para mais informações, consulte o capítulo “Manutenção e limpeza”, Como substituir: Lâmpada.
O conjunto do prato rotativo faz ruído.	Há resíduos de alimentos por baixo do conjunto do prato rotativo.

12.2 Como gerir: Código de erro

Quando ocorre o erro de software, o visor apresenta a mensagem de erro. Nesta secção, encontrará a lista dos problemas que pode resolver por si.

 Código e descrição	 Solução
F240, F439 - os campos táteis no visor não funcionam devidamente.	Limpe a superfície do visor. Certifique-se de que não existe sujidade nos campos táteis.
F908 - o sistema do forno não se consegue ligar com o painel de controlo.	Desligue e ligue o forno.

12.3 Dados de assistência técnica

Se não conseguir encontrar uma solução para o problema, contacte o seu fornecedor ou um Centro de Assistência Técnica Autorizado.

Os dados necessários para o centro de assistência técnica encontram-se na placa de identificação do aparelho. A placa de características está na moldura frontal da cavidade do forno. Não remova a placa de características da cavidade do forno.

Recomendamos que escreva os dados aqui:	
Modelo (MOD.)
Número do produto (PNC)
Número de série (S.N.)

13. EFICIÊNCIA ENERGÉTICA

13.1 Poupança de energia



O forno possui funções que ajudam a poupar energia nos cozinhados de todos os dias.

Certifique-se de que a porta do forno está fechada quando o forno funcionar. Não abra a porta do forno muitas vezes durante o funcionamento. Mantenha a junta da porta limpa e certifique-se de que está bem fixa na posição correta.

Sempre que possível, não pré-aqueça o forno antes de cozinhar.

Quando preparar vários pratos de uma vez, reduza ao mínimo possível os intervalos entre confeções.

Cozinhar com a lâmpada desligada

Desligue a lâmpada durante a cozedura. Ligue-a apenas quando precisar.

14. ESTRUTURA DO MENU

14.1 Menu

Prima para abrir Menu.

Artigo do menu		Aplicação
Favoritos		Lista as definições favoritas.
Opções		Como definir a configuração do forno.
Definições	Configuração	Como definir a configuração do forno.
	Assistência Técnica	Apresenta a configuração e a versão do software.

14.2 Submenu para: Opções

Submenu	Aplicação
Luz	Acende e apaga a lâmpada.

Submenu	Aplicação
Bloqueio para crianças	Previne a ativação acidental do forno. Quando a opção está ativada, o texto "Bloqueio para crianças" aparece no visor quando liga o forno. Para ativar a utilização do forno, escolha as letras do código na ordem alfabética. Acesse ao temporizador, ao funcionamento remoto e a lâmpada está disponível com o Bloqueio para Crianças ativado.
Indicação do tempo	Liga e desliga o relógio.
Estilo Relógio Digital	Altera o formato da indicação da hora apresentada.

14.3 Submenu para: Configuração

Submenu	Descrição
Idioma	Definir o idioma do forno.
Brilho do visor	Define a intensidade do visor.
Sons "teclado"	Liga e desliga o som dos campos de toque. Não é possível silenciar o som para: ①.
Volume do alarme	Define o volume dos tons das teclas e sinais.
Hora	Definir a hora e a data atuais.

14.4 Submenu para: Assistência Técnica

Submenu	Descrição
Modo Demo	Código de ativação / desativação: 2468
Versão do software	Informação sobre a versão do software.
Restaurar configurações	Restaura as definições de fábrica.

15. É FÁCIL!

Antes da primeira utilização, tem de definir:

Idioma	Brilho do visor	Sons "teclado"	Volume do alarme	Hora
--------	-----------------	----------------	------------------	------

Familiarize-se com os ícones básicos no painel de comandos e no visor:



 On / Off	 Menu	 Favoritos	 Temporizador	START / STOP
---	---	--	---	--------------

Começar a utilizar o forno

Início rápido do MO	Inicie o micro-ondas a qualquer momento com definições padrão: 30 seg / 1000W.	Prima:  .
----------------------------	--	--



			
aquecer/cozinhar 100 - 1000 W	cozinhar/alourar intensidade: baixa/ alta	cozinhar/alourar	aquecer líquidos 800 - 1000 W
			
reaquecimento 300 - 700 W	descongelação 100 - 200 W	derreter 100 - 400 W	preparar pipocas 700 - 1000 W

Definições do micro-ondas		Dicas para o micro-ondas
Potência do micro-ondas:	Tempo máximo:	Cubra os alimentos quando cozinhar e reaquecer. Vire ou mexa os alimentos a meio do tempo de descongelação ou cozedura. Coloque a colher no prato quando aquecer líquidos. Coloque os alimentos no forno sem a embalagem (ou apenas embalagens próprias para micro-ondas).
100 - 600 W	59 min	
> 600 W	7 min	

Começar a cozinhar				
Passo 1	Passo 2	Passo 3	Passo 4	Passo 5
 - prima para ligar o forno.	 ... - seleccione a função.	W - defina a potência do micro-on- das.	OK - prima para confirmar.	START - prima para co- meçar a cozi- nhar.

Utilize as funções rápidas para definir o tempo de cozedura.	
Assistência nos 10% finais Utilize a Assistência dos 10% finais para acrescentar tempo extra quando restarem 10% do tempo de cozedura.	Para prolongar o tempo de cozedura prima +1min.

16. PREOCUPAÇÕES AMBIENTAIS

Recicle os materiais que apresentem o símbolo . Coloque a embalagem nos contentores indicados para reciclagem. Ajude a proteger o ambiente e a saúde pública através da reciclagem dos aparelhos eléctricos e electrónicos. Não elimine os aparelhos que tenham o símbolo  juntamente com os resíduos domésticos. Coloque o produto num ponto de recolha para reciclagem local ou contacte as suas autoridades municipais.

ДЛЯ ИДЕАЛЬНЫХ РЕЗУЛЬТАТОВ

Благодарим вас за выбор данного изделия AEG. Этот прибор создан на базе инновационных технологий, оснащен рядом уникальных полезных функций и будет безупречно служить вам долгие годы. Потратьте несколько минут на чтение, чтобы использовать все возможности устройства в полном объеме.

Посетите наш веб-сайт, на котором вы можете:



Найти рекомендации по использованию изделий, руководства по эксплуатации, мастер устранения неисправностей, информацию о техническом обслуживании и ремонте:

www.aeg.ru/support



Зарегистрировать свой продукт, чтобы пользоваться расширенными возможностями обслуживания:

www.promo.electrolux.ru



Приобрести аксессуары, расходные материалы и фирменные запасные части для своего прибора:

www.electrolux-1.ru

ПОДДЕРЖКА КЛИЕНТОВ И ОБСЛУЖИВАНИЕ

Всегда используйте оригинальные запчасти.

При обращении в сервис-центр следует иметь под рукой следующую информацию: Модель, продуктовый номер (PNC), серийный номер.

Данная информация приведена на табличке с техническими данными.

 Внимание / Важные сведения по технике безопасности

 Общая информация и рекомендации

 Информация по охране окружающей среды

Право на изменения сохраняется.

СОДЕРЖАНИЕ

1. СВЕДЕНИЯ ПО ТЕХНИКЕ БЕЗОПАСНОСТИ.....	331	3. ОПИСАНИЕ ПРИБОРА.....	339
1.1 Безопасность детей и лиц с ограниченными возможностями.....	332	3.1 Общий обзор.....	339
1.2 Общая безопасность.....	332	3.2 Аксессуары.....	339
2. УКАЗАНИЯ ПО БЕЗОПАСНОСТИ.....	335	4. ВКЛЮЧЕНИЕ И ВЫКЛЮЧЕНИЕ.....	340
2.1 Установка.....	335	4.1 Панель управления.....	340
2.2 Подключение к электросети.....	336	4.2 Дисплей.....	341
2.3 Использование.....	337	5. ПЕРЕД ПЕРВЫМ ИСПОЛЬЗОВАНИЕМ.....	342
2.4 Уход и чистка.....	338	5.1 Первая чистка	342
2.5 Внутреннее освещение.....	338	5.2 Первое подключение.....	342
2.6 Сервис.....	338		
2.7 Утилизация.....	339		

6. ЕЖЕДНЕВНОЕ ИСПОЛЬЗОВАНИЕ.....	342	10.4 Рекомендованные уровни мощности для различных видов продуктов.....	352
6.1 Установка функции: Гриль + микроволны, Гриль.....	342	10.5 Таблицы приготовления для тестирующих организаций.....	353
6.2 Способ настройки: Режимы нагрева микроволнами.....	344	11. УХОД И ОЧИСТКА.....	354
6.3 Применение: Быстрый пуск микроволновой печи.....	345	11.1 Примечание относительно очистки.....	355
6.4 Режимы нагрева.....	345	12. ПОИСК И УСТРАНЕНИЕ НЕИСПРАВНОСТЕЙ.....	355
7. ФУНКЦИИ ЧАСОВ.....	346	12.1 Что делать, если.....	355
7.1 Описание функций часов.....	346	12.2 Управление: Коды ошибок.....	356
7.2 Способ настройки: Функции часов.....	347	12.3 Данные о техническом обслуживании.....	357
8. ПРИМЕНЕНИЕ: АКСЕССУАРЫ.....	348	13. ЭНЕРГЕТИЧЕСКАЯ ЭФФЕКТИВНОСТЬ.....	357
8.1 Установка принадлежностей.....	348	13.1 Экономия электроэнергии.....	357
9. ДОПОЛНИТЕЛЬНЫЕ ФУНКЦИИ.....	348	14. СТРУКТУРА МЕНЮ.....	357
9.1 Сохранение: Любимые программы.....	348	14.1 Меню.....	357
9.2 Блокировка кнопок.....	349	14.2 Подменю для: Опции.....	358
9.3 Вентилятор охлаждения.....	349	14.3 Подменю для: Настройка.....	358
10. ПОЛЕЗНЫЕ СОВЕТЫ.....	350	14.4 Подменю для: Сервис.....	359
10.1 Рекомендации по приготовлению.....	350	15. ПРОЩЕ ПРОСТОГО!.....	359
10.2 Рекомендации по использованию микроволн.....	350	16. ОХРАНА ОКРУЖАЮЩЕЙ СРЕДЫ.....	361
10.3 Кухонная посуда и материалы, подходящие для использования в микроволновой печи.....	351		

1. ⚠ СВЕДЕНИЯ ПО ТЕХНИКЕ БЕЗОПАСНОСТИ

Перед установкой и эксплуатацией прибора внимательно ознакомьтесь с настоящей Инструкцией по эксплуатации. Изготовитель не несет ответственность за какие-либо травмы или ущерб, возникшие вследствие неправильной установки или эксплуатации. Всегда храните эту Инструкцию под рукой в надежном месте для последующего использования.

1.1 Безопасность детей и лиц с ограниченными возможностями

- Этот прибор может использоваться детьми старше восьми лет и лицами с ограниченными физическими, сенсорными или умственными способностями и с недостаточным опытом или знаниями только при условии нахождения под присмотром лица, отвечающего за их безопасность, или после получения соответствующих инструкций, позволяющих им безопасно эксплуатировать изделие и дающих им представление об опасности, связанной с его эксплуатацией. Детям младше 8 лет и лицам с ярко выраженными и комплексными нарушениями здоровья запрещается находиться рядом с прибором без постоянного присмотра.
- Дети должны находиться под присмотром для недопущения игр с прибором.
- Храните все упаковочные материалы вне досягаемости детей и утилизируйте их надлежащим образом.
- **ВНИМАНИЕ!** Не подпускайте детей и домашних животных к прибору во время его использования, а также после использования, когда прибор ещё не успел остыть. Открытые элементы прибора сильно нагреваются во время эксплуатации.
- Если прибор оснащен устройством защиты детей, его следует включить.
- Очистка и доступное пользователю техническое обслуживание прибора не должно производиться детьми без присмотра.

1.2 Общая безопасность

- Данный прибор предназначен исключительно для приготовления пищи.
- Данный прибор предназначен для бытового применения в отдельном домохозяйстве.

- Данный прибор можно использовать в офисах, гостиничных номерах, мини-гостиницах типа «ночлег и завтрак», сельских жилых домах и других аналогичных жилых помещениях, где такое использование не превышает (среднего) уровня бытового использования.
- Установка прибора и замена кабеля должны выполняться только квалифицированным специалистом и замените кабель.
- Не эксплуатируйте прибор до его установки во встроенную мебель.
- Перед проведением любой операции по обслуживанию отключите прибор от сети питания.
- Во избежание несчастного случая, замену поврежденного кабеля питания должен выполнять изготовитель, авторизованный сервисный центр или специалист с аналогичной квалификацией.
- **ВНИМАНИЕ!** Прежде чем приступить к замене лампочки, выключите прибор, чтобы избежать поражения электрическим током.
- **ВНИМАНИЕ!** Прибор и его открытые элементы сильно нагреваются во время эксплуатации. Будьте осторожны! Не прикасайтесь к нагревательным элементам.
- Всегда используйте кухонные рукавицы для установки или извлечения аксессуаров или посуды из духового шкафа.
- Используйте только вращающийся поддон и опору вращающегося поддона, предназначенные для данного прибора.
- Не включайте функцию микроволновой обработки, когда прибор пуст. Металлические части внутри камеры могут вызвать искрение.
- Запрещается использовать металлические контейнеры для продуктов и напитков во время приготовления в режиме микроволновой обработки. Данное требование не применимо к случаям, когда производитель четко

указывает размеры и форму металлических контейнеров, пригодных для использования в режиме микроволновой обработки.

- **ВНИМАНИЕ!** Если дверца или уплотнения дверцы повреждены, пользоваться прибором можно будет только после проведения ремонта квалифицированным специалистом.
- **ВНИМАНИЕ!** Все операции по обслуживанию и ремонту, в ходе которых требуется снятие кожуха, защищающего от воздействия микроволнового излучения, должны выполняться только квалифицированным специалистом.
- **ВНИМАНИЕ!** Не нагревайте жидкости и другие продукты в герметичных контейнерах. Они могут взорваться.
- Используйте только ту посуду, которая подходит для использования в микроволновой печи.
- При нагреве продуктов в пластиковых или бумажных контейнерах не оставляйте прибор без присмотра: может произойти возгорание.
- Прибор предназначен для нагревания продуктов и напитков. Сушка продуктов или одежды, а также разогрев грелок, тапочек, губок, влажной ткани и аналогичных предметов несет в себе риск травм, возгорания или пожара.
- При появлении дыма выключите прибор или извлеките вилку кабеля питания из розетки и не открывайте дверцу, чтобы не допустить приток воздуха к источнику возгорания.
- Разогревание напитков в режиме микроволновой обработки может привести к задержанному бурному вскипанию. Следует проявлять осторожность при извлечении контейнера.
- Содержимое бутылочек и баночек с детским питанием необходимо перемешать или взболтать и проверить температуру перед употреблением, чтобы избежать ожогов.

- Не следует нагревать в приборе как яйца в скорлупе, так и яйца, сваренные вкрутую, так как они могут взорваться даже после завершения нагрева в режиме микроволновой обработки.
- Прибор следует регулярно чистить, а также удалять из него все остатки продуктов.
- Не используйте для очистки прибора пароочиститель.
- Не используйте для очистки стеклянной дверцы жесткие абразивные чистящие средства или острые металлические скребки, так как ими можно поцарапать поверхность стекла, в результате чего оно может лопнуть.
- Если не поддерживать прибор в чистом состоянии, это может привести к повреждению его поверхности, что, в свою очередь, может сократить срок службы прибора и стать причиной возникновения опасной ситуации.

2. УКАЗАНИЯ ПО БЕЗОПАСНОСТИ

2.1 Установка

**ВНИМАНИЕ!**

Установка прибора должна осуществляться только квалифицированным специалистом!

- Удалите всю упаковку.
- Не устанавливайте и не подключайте прибор, имеющий повреждения.
- Следуйте инструкциям по установке, входящим в комплект прибора.
- Всегда будьте осторожны при перемещении прибора, поскольку он тяжелый. Всегда используйте защитные перчатки и закрытую обувь.
- При перемещении прибора не тяните за его ручку.
- Разместите прибор в безопасном месте, отвечающем требованиям установки.
- Обеспечьте наличие минимально допустимых зазоров между соседними приборами и предметами мебели.
- Перед установкой прибора убедитесь, что дверца духового шкафа свободно открывается.
- Прибор оснащен электрической системой охлаждения. Она работает от сети электропитания.
- Требования к устойчивости встроенного прибора должны соответствовать стандарту DIN 68930.

УКАЗАНИЯ ПО БЕЗОПАСНОСТИ

Минимальная высота шкафа (минимальная высота шкафа под столешницей)	444 (460) мм
Ширина шкафа	560 мм
Глубина шкафа	550 (550) мм
Высота передней стороны прибора	455 мм
Высота задней стороны прибора	440 мм
Ширина передней стороны прибора	595 мм
Ширина задней стороны прибора	559 мм
Глубина прибора	567 мм
Глубина встраивания прибора	546 мм
Глубина с открытой дверцей	882 мм
Минимальный размер отверстия для вентиляции. Отверстие сзади в нижней части	560x20 мм
Длина кабеля электропитания. Кабель находится в правом углу сзади	1500 мм
Винты крепления	3.5x25 мм

2.2 Подключение к электросети



ВНИМАНИЕ!

Существует риск пожара и поражения электрическим током.

- Все электрические подключения должны производиться квалифицированным электриком.
- Прибор должен быть заземлен.
- Убедитесь, что параметры, указанные на табличке с техническими данными, соответствуют характеристикам электросети.
- Включайте машину только в правильно установленную электрическую розетку с контактом заземления.
- Не пользуйтесь тройниками и удлинителями.
- Следите за тем, чтобы не повредить вилку сетевого шнура и сетевой кабель. В случае необходимости замены сетевого шнура обратитесь в наш авторизованный сервисный центр.
- Не допускайте контакта сетевых кабелей или их приближения к дверце прибора или нише под прибором, особенно если дверца сильно нагрета.

- Детали, защищающие токоведущие или изолированные части прибора, должны быть закреплены так, чтобы их было невозможно удалить без специальных инструментов.
- Вставляйте вилку сетевого кабеля в розетку только в конце установки прибора. Убедитесь, что после установки прибора к вилке сетевого шнура есть свободный доступ.
- Не подключайте прибор к розетке электропитания, если она плохо закреплена или если вилка неплотно входит в розетку.
- Для отключения прибора от электросети не тяните за кабель электропитания. Всегда беритесь за вилку сетевого шнура.
- Следует использовать подходящие размыкающие устройства: автоматические выключатели, предохранители (резьбовые плавкие предохранители следует выкручивать из гнезда), УЗО и контакторы.
- Прибор должен быть подключен к электросети через устройство для изоляции, позволяющее отсоединять от сети все контакты. Устройство для изоляции должно обеспечивать зазор между разомкнутыми контактами не менее 3 мм.
- Данный прибор поставляется с сетевым шнуром и вилкой.

2.3 Использование



ВНИМАНИЕ!

Существует риск травмы, ожога и поражения электрическим током или взрыва.

- Не вносите изменения в конструкцию данного прибора.
- Убедитесь, что вентиляционные отверстия не заблокированы.
- Не оставляйте прибор без присмотра во время его работы.
- Выключайте прибор после каждого использования.
- Соблюдайте осторожность при открывании дверцы прибора во время его работы. Может произойти выброс горячего воздуха.
- При использовании прибора не касайтесь его мокрыми руками. Не касайтесь прибора, если на него попала вода.
- Не надавливайте на открытую дверцу.
- Не используйте прибор как столешницу или подставку для каких-либо предметов.
- Открывайте дверцу прибора, соблюдая осторожность. Использование спиртосодержащих ингредиентов может привести к образованию спиртовых паров в воздухе.
- Не допускайте контакта искр или открытого пламени с прибором при открывании дверцы.
- Не ставьте на прибор или рядом с ним легковоспламеняющиеся материалы или пропитанные ими предметы.
- Не используйте режим микроволновой печи для предварительного нагрева духового шкафа.



ВНИМАНИЕ!

Существует риск повреждения прибора.

- Для предупреждения повреждения и изменения цвета эмали.
 - Не кладите непосредственно на дно прибора алюминиевую фольгу.
 - Не заливайте воду непосредственно в горячий прибор.
 - Не храните влажную посуду и еду в приборе после окончания приготовления.
 - Соблюдайте осторожность при снятии или установке аксессуаров.

УКАЗАНИЯ ПО БЕЗОПАСНОСТИ

- Изменение цвета эмали или нержавеющей стали не влияет на эффективность работы прибора.
- Всегда готовьте при закрытой дверце прибора.
- В случае установки прибора за мебельной панелью (например, дверцей) позаботьтесь о том, чтобы во время работы прибора дверца ни в коем случае не оказывалась закрытой. Тепло и влага, образующиеся за закрытой дверцей или мебельной панелью, могут привести к последующему повреждению прибора, места его установки или пола. Не закрывайте дверцу мебели до полного остывания прибора после использования.

2.4 Уход и чистка



ВНИМАНИЕ!

Существует риск травмы, пожара или повреждения прибора.

- Перед выполнением операций по очистке и уходу выключите прибор и извлеките вилку сетевого кабеля из розетки.
- Убедитесь, что прибор остыл. В противном случае стеклянные панели могут треснуть.
- Поврежденные стеклянные панели следует заменять незамедлительно. Обратитесь в авторизованный сервисный центр.
- Соблюдайте осторожность при снятии дверцы с прибора. Дверца – тяжелая!
- Не забывайте вытирать после каждого использования внутреннюю камеру, вращающийся поддон и дверцу. Производимый в ходе работы прибора пар конденсируется на стенках внутренней камеры, что может вызвать коррозию.
- Во избежание повреждения покрытия прибора производите его регулярную очистку.
- Жир и остатки продуктов в приборе могут привести к возгоранию и электроискрению во время работы функции микроволновой обработки.
- Очищайте прибор мягкой влажной тряпкой. Используйте только нейтральные моющие средства. Не используйте абразивные средства, царапающие губки, растворители или металлические предметы.
- В случае использования спрея для очистки следуйте инструкции по безопасности на его упаковке.

2.5 Внутреннее освещение



ВНИМАНИЕ!

Существует опасность поражения электрическим током.

- О лампах внутри прибора и лампах, продаваемых отдельно в качестве запасных частей: данные лампы рассчитаны на работу в бытовых приборах в исключительно сложных температурных, вибрационных и влажностных условиях или предназначены для передачи информации о рабочем состоянии прибора. Они не предназначены для использования в других приборах и не подходят для освещения бытовых помещений.
- Данный продукт содержит источник света класса энергоэффективности G.
- Используйте только лампы той же спецификации.

2.6 Сервис

- Для ремонта прибора обратитесь в авторизованный сервисный центр.
- Используйте только оригинальные запасные части.

2.7 Утилизация



ВНИМАНИЕ!

Существует опасность травмы или удушья.

- Для получения информации о надлежащей утилизации прибора обратитесь в местные муниципальные органы власти.
- Отключите прибор от сети электропитания.
- Обрежьте кабель электропитания как можно ближе к прибору и утилизируйте его.
- Удалите защелку дверцы, чтобы дети или домашние животные не оказались заблокированными в приборе.

3. ОПИСАНИЕ ПРИБОРА

3.1 Общий обзор

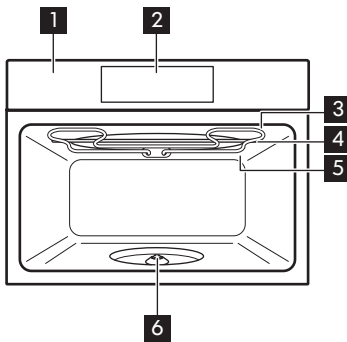

- 1 Панель управления
- 2 Дисплей
- 3 Нагревательный элемент
- 4 Генератор микроволн
- 5 Лампа освещения
- 6 Вал вращающегося поддона

3.2 Аксессуары

Комплект Turntable

Для подготовки продуктов.

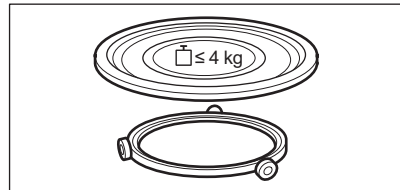

Набор подставок для гриля

Для приготовления на гриле.

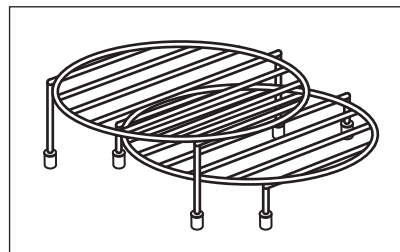

4. ВКЛЮЧЕНИЕ И ВЫКЛЮЧЕНИЕ.

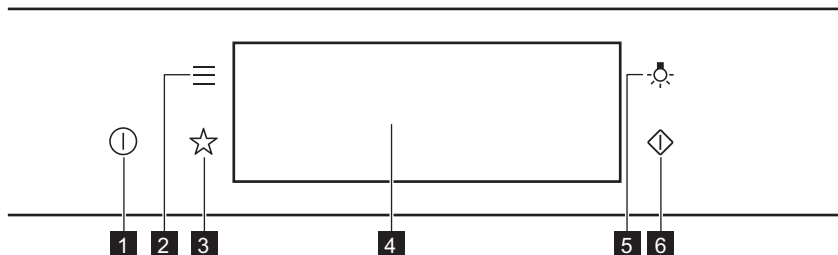

4.1 Панель управления



1	ВКП / ВЫКП	Нажмите и удерживайте для включения и выключения духового шкафа.
2	Меню	Список режимов духового шкафа.
3	Любимые программы	Список любимых настроек.
4	Дисплей	Отображение текущих настроек духового шкафа.
5	Выключатель лампы	Включение и выключение лампы освещения.
6	Быстрый пуск микроволновой печи	Включение режима микроволновой обработки (1000 Вт на 30 сек).

<p>Нажимайте кнопку</p>	<p>Переместите</p>	<p>Нажмите и удерживайте</p>
Коснитесь поверхности кончиком пальца.	Проведите кончиком пальца по поверхности.	Коснитесь поверхности и удерживайте 3 секунды.

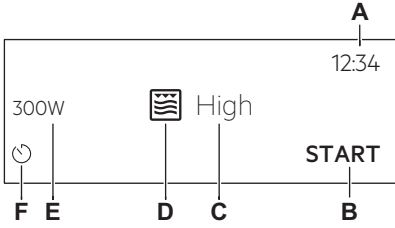
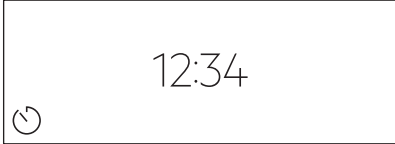
4.2 Дисплей

 <p>The diagram shows a control panel with the following elements labeled with letters A through F:</p> <ul style="list-style-type: none"> A: Points to the digital display showing '12:34'. B: Points to the 'START' button. C: Points to the 'High' power level indicator. D: Points to the grill intensity icon. E: Points to the power level indicator '300W'. F: Points to the timer icon. 	<p>После включения на дисплее появится главный экран с выбранным режимом и уровнем интенсивности гриля по умолчанию.</p> <p>A. Установка Времени Суток B. ПУСК/СТОП C. Интенсивность гриля D. Режимы нагрева E. Мощность микроволн F. Таймер</p>
 <p>The screenshot shows a digital display with the time '12:34' and a small timer icon in the bottom left corner.</p>	<p>Если не воспользоваться духовым шкафом в течение 2 минут, дисплей переходит в режим ожидания.</p>
 <p>The screenshot shows the display during cooking with the following information: '1000W', a grill icon, '1m23s', '+30s', and the word 'STOP'.</p>	<p>В ходе приготовления на дисплей выводятся заданные функции и другие доступные опции.</p>

Индикаторы, отображаемые на дисплее

Основные индикаторы – навигация по дисплею.

<p>OK Подтверждение выбора / параметра настройки.</p>	<p>< Возврат на один уровень в меню.</p>	<p>↶ Отмена последнего действия.</p>	<p>☑ Включение и выключение опций.</p>
--	--	---	---

Индикаторы функции **Звуковой сигнал**. — по истечении установленного времени приготовления раздается звуковой сигнал.

<p>🔔 Функция включена.</p>	<p>🔔 STOP Функция включена. Приготовление автоматически прекращается.</p>	<p>🔔 Звуковая сигнализация отключена.</p>
---------------------------------------	--	--

Индикаторы таймеров

ПЕРЕД ПЕРВЫМ ИСПОЛЬЗОВАНИЕМ



Установка функции: Отложенный запуск.



Отмена настройки.

5. ПЕРЕД ПЕРВЫМ ИСПОЛЬЗОВАНИЕМ



ВНИМАНИЕ!

См. главы, содержащие Сведения по технике безопасности.

5.1 Первая чистка

Шаг 1	Шаг 2	Шаг 3
Извлеките все принадлежности из духового шкафа.	Используйте мягкую ткань, смоченную в теплой воде с добавлением мягкого моющего средства, для очистки духового шкафа и принадлежностей.	Поместите принадлежности в духовой шкаф.

5.2 Первое подключение

После первого подключения на дисплее отображается приветственное сообщение. Необходимо настроить: Выбрать Язык, Яркость дисплея, Тоны Кнопок, Громкость сигнала, Установка Времени Суток.

6. ЕЖЕДНЕВНОЕ ИСПОЛЬЗОВАНИЕ



ВНИМАНИЕ!

См. главы, содержащие Сведения по технике безопасности.

6.1 Установка функции: Гриль + микроволны, Гриль

Духовой шкаф может производить шум во время работы: Гриль + микроволны. Для данной функции это нормально.

Установка функции: Гриль + микроволны	
Шаг 1	Установите нижнюю решетку для гриля.
Шаг 2	Включите духовой шкаф. На дисплее отобразится режим нагрева по умолчанию.

ЕЖЕДНЕВНОЕ ИСПОЛЬЗОВАНИЕ

Установка функции: Гриль + микроволны	
Шаг 3	Для входа в подменю нажмите символ режима нагрева.
Шаг 4	Выберите режим:  . Нажмите: ОК.
Шаг 5	Выберите уровень интенсивности гриля.
Функция	Уровень интенсивности нагрева гриля
Lo	Низкий
Hi	Высокий
Шаг 6	Нажмите: ОК.
Шаг 7	Нажмите: START .
STOP — нажмите для выключения духового шкафа.	
Шаг 8	Выключите духовой шкаф.

При использовании функции мощность микроволн ограничена значением 500 Вт: Гриль + микроволны.

Установка функции: Гриль	
Шаг 1	Установите полку для гриля на высокую мощность.
Шаг 2	Включите духовой шкаф. На дисплее отобразится режим нагрева по умолчанию.
Шаг 3	Для входа в подменю нажмите символ режима нагрева.
Шаг 4	Выберите режим:  . Нажмите: ОК.
Шаг 5	Выберите уровень интенсивности гриля.
Функция	Уровень интенсивности нагрева гриля
Lo	Низкий
Hi	Высокий

Установка функции: Гриль	
Шаг 6	Нажмите: OK.
Шаг 7	Нажмите: START .
STOP - нажмите для выключения функции.	
Шаг 8	Выключите духовой шкаф.

6.2 Способ настройки: Режимы нагрева микроволнами

Шаг 1	Включите духовой шкаф.
Шаг 2	Для входа в подменю нажмите символ режима нагрева.
Шаг 3	Выберите режим нагрева для микроволновой обработки и нажмите: OK. На дисплее отображается мощность микроволн.
Шаг 4	Настройка: мощность микроволн. Нажмите OK.
Шаг 5	Нажмите: START .
STOP - нажмите для выключения функции.	
Шаг 6	Выключите духовой шкаф.

Максимальная продолжительность функций микроволновой обработки зависит от мощности микроволн.

МОЩНОСТЬ МИКРОВОЛН	МАКСИМАЛЬНОЕ ВРЕМЯ
100–600 Вт	59 минут
Более 600 Вт	7 минут



Открывание дверцы приводит к остановке работы функции. Чтобы начать, нажмите кнопку START .

Пробуйте!





6.3 Применение: Быстрый пуск микроволновой печи

Шаг 1	Нажмите и удерживайте  . Микроволновая обработка будет продолжаться 30 секунд.	
Шаг 2	Увеличение времени приготовления.	
	Для перехода в настройки времени нажмите текущее значение времени. Установка времени приготовления.	Нажмите +30 секунд .
Быстрый пуск микроволновой печи позволяет в любой момент включить режим микроволновой обработки.		





6.4 Режимы нагрева

СТАНДАРТНЫЕ

Режим нагрева	Применение
 Гриль	Приготовление на гриле тонких продуктов и тостов.
 Гриль + микроволны	Для быстрого приготовления продуктов и одновременного их подрумянивания. Можно настроить 2 уровня интенсивности гриля: низкий и высокий.
 Микроволны	Подогрев, приготовление, диапазон мощности: 100–1000 Вт

ФУНКЦИИ ЧАСОВ

Микроволны

Режим нагрева	Применение
 Размораживание	Размораживание мяса, рыбы, тортов, диапазон мощности: 100–200 Вт
 Растапливание	Растапливание шоколада и сливочного масла, диапазон мощности: 100–400 Вт
 Разогрев	Подогрев готовых блюд и деликатных продуктов, диапазон мощности: 300–700 Вт
 Попкорн	Приготовление попкорна, диапазон мощности: 700–1000 Вт
 Жидкость	Подогрев напитков и супов, диапазон мощности: 800–1000 Вт

7. ФУНКЦИИ ЧАСОВ

7.1 Описание функций часов

Часы	Применение
Время приготовления	Установка продолжительности приготовления. Максимум 23 ч 59 мин.
Завершить действи	Выбор действия по окончании работы таймера.
Коррекция времени	Увеличение заданного времени приготовления.
Напоминание	Установка обратного отсчета. Максимум 23 ч 59 мин. Данная функция не влияет на работу духового шкафа.
Таймер прямого отсчета	Контроль времени работы функции. Таймер прямого отсчета — можно включить и выключить.

7.2 Способ настройки: Функции часов

Настройка часов	
Шаг 1	Нажмите Установка Времени Суток.
Шаг 2	Установите время. Нажмите ОК.

Установка времени приготовления	
Шаг 1	Выберите режим нагрева.
Шаг 2	Нажмите  .
Шаг 3	Установите время. Нажмите ОК.

Выбор опции окончания приготовления	
Шаг 1	Выберите режим нагрева.
Шаг 2	Нажмите  .
Шаг 3	Задайте время приготовления.
Шаг 4	Нажмите: ● ● ● .
Шаг 5	Нажмите: Завершить действи.
Шаг 6	Выберите требуемое значения параметра: Завершить действи.
Шаг 7	Нажмите: ОК. Повторяйте данное действие, пока на дисплее не отобразится главный экран.

Увеличение заданного времени приготовления	
Если до окончания времени приготовления остается 10 %, а блюдо не выглядит готовым, можно увеличить время приготовления. Также можно изменить режим нагрева.	
Для увеличения времени приготовления нажмите значок +1min .	

ПРИМЕНЕНИЕ: АКСЕССУАРЫ

Изменение настроек таймера

Шаг 1 Нажмите .

Шаг 2 Задайте значение таймера.

Шаг 3 Нажмите ОК.

Заданное время можно изменить во время приготовления в любой момент.

8. ПРИМЕНЕНИЕ: АКСЕССУАРЫ

8.1 Установка принадлежностей

Используйте только подходящую посуду и материалы. См. главу «Указания и рекомендации», раздел «Подходящая для микроволновой обработки кухонная посуда и материалы».

Комплект Turntable:

Всегда готовьте продукты на вращающемся поддоне.
Установите роликовую направляющую вокруг вала вращающегося поддона.
Поместите вращающийся стеклянный поддон на роликовую направляющую.
Используйте только комплект с вращающимся поддоном, поставляемый вместе с духовым шкафом.

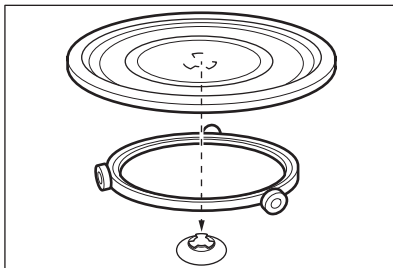

Набор подставок для гриля:

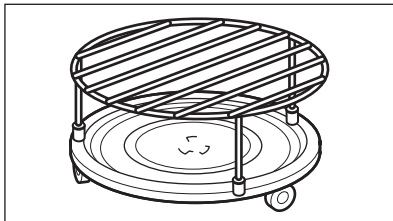

Установите подставку для гриля на вращающийся поддон силиконовыми ножками вниз.



9. ДОПОЛНИТЕЛЬНЫЕ ФУНКЦИИ



9.1 Сохранение: Любимые программы

В памяти прибора можно сохранить избранные настройки, например: режим нагрева, время приготовления или функцию очистки. В памяти прибора можно сохранить три избранные настройки.

Шаг 1	Включите духовой шкаф.
Шаг 2	Выберите необходимую настройку.
Шаг 3	Нажмите:  . Выберите: Любимые программы.
Шаг 4	Выберите: Сохранить текущие настройки.
Шаг 5	Нажмите + , чтобы добавить настройку в список: Любимые программы. Нажмите OK .
<p> — нажмите для сброса настройки.</p> <p> — нажмите для отмены выбора настройки.</p>	

9.2 Блокировка кнопок

Эта функция предотвращает случайное изменение режима нагрева.

Шаг 1	Включите духовой шкаф.
Шаг 2	Настройка режима нагрева.
Шаг 3	 ,  — нажмите одновременно, чтобы включить эту функцию.
Чтобы включить функцию, повторите шаг 3.	

9.3 Вентилятор охлаждения

Во время работы духового шкафа вентилятор автоматически включается, чтобы охладить поверхности духового шкафа. При выключении духового шкафа вентилятор продолжает работать до тех пор, пока прибор не остынет.

10. ПОЛЕЗНЫЕ СОВЕТЫ

10.1 Рекомендации по приготовлению



Приведенные в таблицах значения температуры и времени приготовления являются ориентировочными. Они зависят от рецепта, а также от качества и количества используемых ингредиентов.

Ваш духовой шкаф может отличаться характером приготовления от предыдущего. В рекомендациях ниже приводятся рекомендуемые функции нагрева и настройки времени приготовления для определенных видов продуктов.

Если найти установки для конкретного рецепта не удастся, поищите похожий рецепт.

Более подробные рекомендации по приготовлению вы найдете в таблицах приготовления пищи на нашем вебсайте. Для выбора книги рецептов проверьте код PNC на табличке с техническими данными на передней рамке внутренней камеры духового шкафа.

10.2 Рекомендации по использованию микроволн

Давайте готовить!

Не помещайте продукты непосредственно на вращающийся поддон. Всегда используйте посуду, пригодную для эксплуатации в микроволновой печи.

Ставьте посуду в центр вращающегося поддона.

Вследствие контакта с слишком горячими или слишком холодными предметами поддон может треснуть.

Переворачивайте или перемешивайте продукты по истечении половины времени приготовления или размораживания.

Время от времени помешивайте жидкие блюда.

Перемешивайте пищу перед подачей к столу.

Во время приготовления и разогрева накрывайте пищу.

При нагреве напитков для улучшения распределения тепла положите в бутылку или стакан подходящую для микроволновой печи ложку.

Поместите продукты в духовой шкаф без упаковки. Готовые блюда можно помещать в духовой шкаф в упаковке только если упаковка пригодна для использования в микроволновой печи (см. сведения на упаковке).



Приготовление в микроволновой печи

Накрывайте продукты в ходе приготовления. Если требуется создать корочку, готовьте, не накрывая.

Не перегревайте блюда, устанавливая слишком высокую мощность и время. Продукты могут потерять влагу, сгореть или стать причиной пожара.

Не используйте духовой шкаф для приготовления яиц в скорлупе и моллюсков/улиток, так как они могут взрываться. Перед разогревом протыкайте желтки в яичнице.

Перед приготовлением сделайте в кожице или кожуре продуктов несколько отверстий.

Нарезайте овощи на кусочки сходного размера.

После выключения духового шкафа выньте продукты и оставьте на несколько минут для равномерного распределения тепла.



Размораживание в микроволновой печи

Положите замороженный неразвернутый продукт в небольшой перевернутой тарелке в контейнер, на поднос для размораживания или в пластиковое сито, чтобы образующаяся при размораживании жидкость могла свободно стекать.

Извлекайте из прибора разморожившиеся продукты.

Для приготовления овощей и фруктов без предварительного размораживания можно задать более высокую мощность микроволновой обработки.

10.3 Кухонная посуда и материалы, подходящие для использования в микроволновой печи

Для приготовления с микроволнами используйте только подходящую посуду и материалы. Воспользуйтесь для справки таблицей ниже.

Перед использованием кухонной посуды/материалов сверяйтесь с их спецификацией.



Посуда/материал				
Огнеупорное стекло и фарфор без металлических примесей, например, жаростойкое стекло.	✓	✓	✓	✓
Нежаростойкое стекло и изделия из фарфора без декоративного покрытия из серебра, золота, платины или других металлов	✓	✗	✗	✗
Стекло и витрокерамика из огнестойкого/морозостойкого материала	✓	✓	✓	✓
Керамика и фаянс без элементов из кварца или металла, а также без металлосодержащей глазури	✓	✓	✗	✗
Изделия из керамики, фарфора и фаянса с неглазурованным дном или маленькими отверстиями, например, на ручках	✗	✗	✗	✗
Жаростойкий пластик, выдерживающий температуру до 200 °C	✓	✓	✗	✗

ПОЛЕЗНЫЕ СОВЕТЫ

Посуда/материал				
Картон, бумага	✓	x	x	x
Пищевая пленка	✓	x	x	x
Пленка для жарки, пригодная для использования в микроволновой печи	✓	✓	x	x
Посуда для жарки из металла, например, эмалированная, чугунная	x	x	✓	x
Формы для выпечки, черные лакированные или с силиконовым покрытием	x	x	✓	x
Посуда для использования в микроволновой печи, например, сковороды Crisp rap	x	✓	x	x
Набор подставок для гриля	x	x	✓	✓

10.4 Рекомендованные уровни мощности для различных видов продуктов

Данные, приведенные в таблице, предназначены исключительно для ознакомления.

800–1000 Вт	
 Обжаривание в начале процесса приготовления	 Подогрев жидкостей

500–700 Вт					
					
Приготовление овощей	Приготовление яиц	Приготовление на медленном огне	Варка риса	Подогрев порционных блюд	Размораживание и разогрев замороженных блюд





300–400 Вт		
		
Растапливание сыра, шоколада, сливочного масла	Приготовление / Разогрев деликатных продуктов	Непрерывное приготовление

100–200 Вт				
				
Подогрев детского питания	Размораживание хлеба	Размораживание фруктов и пирожных	Размораживание сыра, сливок, сливочного масла	Размораживание мяса, птицы

10.5 Таблицы приготовления для тестирующих организаций.

Информация для испытательных организаций

Испытания согласно IEC 60705.

ФУНКЦИЯ МИКРОВОЛНОВОЙ ПЕЧИ	 POWER (Вт)	 (кг)		 (мин)	
Бисквитный пирог	600	0.475	Комплект вращающегося поддона	5 - 7	-

УХОД И ОЧИСТКА

ФУНКЦИЯ МИКРОВОЛНОВОЙ ПЕЧИ	 (Вт)	 (кг)		 (мин)	
Мясной рулет	500	0.9	Комплект вращающегося поддона	18 - 20	-
Белковый крем	500	1	Комплект вращающегося поддона	15 - 17	-
Размораживание мяса	200	0.5	Комплект вращающегося поддона	8 - 9	-

**Используйте функцию: Гриль при помощи микроволн.
Используйте решетку для нижнего гриля.**

КОМБИНИРОВАННЫЙ РЕЖИМ С МИКРОВОЛНАМИ	 (Вт)	 Уровень интенсивности нагрева гриля	 (мин)	
Картофельная запеканка, 1,1 кг	300	низкий	30 - 35	-
Цыпленок, 1,1 кг	300	высокий	30 - 35	Поместите мясо в круглую стеклянную емкость.

11. УХОД И ОЧИСТКА





ВНИМАНИЕ!

См. главы, содержащие Сведения по технике безопасности.

ПОИСК И УСТРАНЕНИЕ НЕИСПРАВНОСТЕЙ

11.1 Примечание относительно очистки

 Чистящие средства	Переднюю часть прибора протирайте мягкой тканью, смоченной в теплой воде с мягким моющим средством.
	Для чистки металлических поверхностей используйте чистящее средство.
	Очищайте пятна мягким моющим средством.
 Ежедневное использование	Внутреннюю камеру необходимо мыть после каждого использования. Накопление жира или других отложений может привести к возгоранию. Тщательно очищайте верх внутренней камеры от остатков пищи и жира.
	Не держите продукты в микроволновой печи дольше 20 минут. После каждого использования вытирайте камеру насухо мягкой тряпкой.
 Аксессуары	После каждого использования все аксессуары микроволновой печи следует очистить и просушить. Перед очисткой убедитесь, что вращающийся поддон остыл. Вращающийся поддон может треснуть. Используйте для этого мягкую тряпку, смоченную в теплой воде с мягким моющим средством. Не мойте аксессуары в посудомоечной машине.
	Не используйте для мытья аксессуаров с антипригарным покрытием абразивные чистящие средства или предметы с острыми краями.



12. ПОИСК И УСТРАНЕНИЕ НЕИСПРАВНОСТЕЙ









ВНИМАНИЕ!

См. главы, содержащие Сведения по технике безопасности.

12.1 Что делать, если...

 Духовой шкаф не включается или не нагревается	
 Возможная причина	 Способ устранения
Духовой шкаф не подключен к сети электропитания, или подключение выполнено неверно.	Проверьте правильность подключения духового шкафа к сети электропитания.



 Духовой шкаф не включается или не нагревается	
 Возможная причина	 Способ устранения
Не установлено время.	Установите текущее время. Подробнее см. главу «Функции часов», раздел «Настройка функции» Функции часов.
Дверца не закрыта как следует.	Полностью закройте дверцу.
Сработал предохранитель.	Проверьте, не является ли предохранитель причиной неисправности. В случае повторного возникновения неисправности обратитесь к квалифицированному электрику.
Включена функция духового шкафа «Защита от детей».	См. главу «Меню», подменю: Опции.



 Компоненты	
 Описание	 Способ устранения
Лампа перегорела.	Замените лампу. Подробнее см. главу «Уход и очистка», раздел «Замена лампы».
Комплект с вращающимся поддоном производит шум.	Под вращающимся поддоном находятся остатки пищи.

12.2 Управление: Коды ошибок

В случае ошибки программного обеспечения на дисплее отображается сообщение об ошибке.

В данном разделе вы найдете список неисправностей, с которыми вы сможете справиться самостоятельно.

 Код и описание	 решение
F240, F439 - сенсоры дисплея не функционируют надлежащим образом.	Очистите поверхность дисплея. Убедитесь, что на сенсорах не осталось грязи.

 Код и описание	 решение
F908 - не удается установить соединение между панелью управления и духовым шкафом.	Выключите и снова включите духовой шкаф.

12.3 Данные о техническом обслуживании

Если самостоятельно справиться с проблемой не удается, обратитесь в магазин, в котором был приобретен прибор, или в авторизованный сервисный центр.

Данные для сервисных центров находятся на табличке с техническими данными.

Табличка с техническими данными находится на передней рамке камеры духового шкафа. Не удаляйте табличку с техническими данными из внутренней камеры духового шкафа.

Рекомендуем записать их здесь:	
Название модели (MOD.)
Продуктовый номер (PNC)
Серийный номер (S.N.)

13. ЭНЕРГЕТИЧЕСКАЯ ЭФФЕКТИВНОСТЬ

13.1 Экономия электроэнергии

	Духовой шкаф имеет функции для экономии электроэнергии во время приготовления.
---	--

Позаботьтесь о том, чтобы дверца во время работы духового шкафа была плотно закрыта. Во время приготовления не открывайте дверцу слишком часто. Следите за чистой уплотнителем дверцы и за тем, чтобы он был как следует закреплен на своем месте.

При возможности не производите предварительный разогрев духового шкафа перед приготовлением.

Во время приготовления нескольких блюд за раз сводите перерывы между выпечкой/жаркой к минимуму.

Приготовление с выключенной лампой освещения

Выключите лампу на время приготовления. Включайте ее только при необходимости.

14. СТРУКТУРА МЕНЮ

14.1 Меню

Нажмите , чтобы открыть Меню.

СТРУКТУРА МЕНЮ

Элемент меню		Применение
Любимые программы		Список любимых настроек.
Опции		Выбор настроек духового шкафа.
Настройки	Настройка	Выбор настроек духового шкафа.
	Сервис	Отображение на дисплее версии и конфигурации программного обеспечения.

14.2 Подменю для: Опции

Подменю	Применение
Освещение	Включение и выключение лампы освещения.
Защита детей	Эта функция предотвращает случайное включение духового шкафа. Если данная опция выбрана, при включении духового шкафа на дисплее появляется сообщение «Защита от детей». Чтобы воспользоваться духовым шкафом, введите буквы кода в алфавитном порядке. Доступ к таймеру, удаленному режиму и лампе возможен при включенной функции «Защита от детей».
Индикация времени	Включение и выключение часов.
Вид электронных часов	Изменение формата индикации времени.

14.3 Подменю для: Настройка

Подменю	Описание
Выбрать Язык	Выбор языка для духового шкафа.
Яркость дисплея	Выбор яркости дисплея.
Тоны Кнопок	Включение и выключение звукового сопровождения при нажатии сенсорных кнопок. Невозможно отключить звуковое сопровождение для: ①.

Подменю	Описание
Громкость сигнала	Выбор громкости тона кнопок и звуковых сигналов.
Установка Времени Суток	Установка текущей даты и времени.

14.4 Подменю для: Сервис





Подменю	Описание
Деморежим	Код включения / отключения: 2468
Версия ПО (программного обеспечения)	Сведения о версии программного обеспечения.
Заводские Установки	Восстановление заводских установок

15. ПРОЩЕ ПРОСТОГО!

Перед первым использованием необходимо настроить:





Выбрать Язык	Яркость дисплея	Тоны Кнопок	Громкость сигнала	Установка Времени Суток
--------------	-----------------	-------------	-------------------	-------------------------

Ознакомьтесь с основными значками на панели управления и на дисплее:

 ВКЛ / ВЫКЛ	 Меню	 Любимые программы	 Таймер	START / STOP
--	--	---	--	--------------

Приступите к использованию духового шкафа



Быстрый старт микроволновой обработки	Запуск в любое время режима микроволновой обработки с установками по умолчанию: 30 сек/ 1000 Вт.	Нажмите:  .
--	--	--

			
---	---	---	---

ПРОЦЕ ПРОСТОГО!



подогрев / приготовление 100–1000 Вт	приготовление / поджаривание интенсивность: низкая / высокая	приготовление / поджаривание	подогрев жидкостей 800–1000 Вт
			
разогрев 300–700 Вт	размораживание 100–200 Вт	растопление 100–400 Вт	приготовление попкорна 700–1000 Вт

Настройки микроволновой печи		Советы по использованию микроволновой печи
Мощность микроволн:	Максимальное время:	<p>Во время приготовления и разогрева накрывайте пищу.</p> <p>Переворачивайте или перемешивайте продукты по истечении половины времени приготовления или размораживания.</p> <p>При подогреве жидкостей положите ложку на блюдо.</p> <p>Помещайте продукты в духовой шкаф, освободив их от упаковки (за исключением случаев, когда упаковка пригодна для использования в микроволновой печи).</p>
100–600 Вт	59 мин	
> 600 Вт	7 мин	

Начните приготовление				
Шаг 1	Шаг 2	Шаг 3	Шаг 4	Шаг 5
 - нажмите для включения духового шкафа.	 ... - выберите функцию.	Вт — установите мощность микроволн.	OK - нажмите для подтверждения.	START - нажмите, чтобы начать приготовление.

При помощи функций быстрого выполнения задайте время приготовления.	
Последний штрих 10% Используйте функцию «Последний штрих 10%» для добавления времени, когда до окончания приготовления остается 10% времени.	Для увеличения времени приготовления нажмите значок +1min .

16. ОХРАНА ОКРУЖАЮЩЕЙ СРЕДЫ

Материалы с символом  следует сдавать на переработку. Положите упаковку в соответствующие контейнеры для сбора вторичного сырья. Принимая участие в переработке старого электробытового оборудования, Вы помогаете защитить окружающую среду и здоровье человека. Не выбрасывайте вместе с бытовыми отходами бытовую технику, помеченную символом . Прибор следует доставить в место отдельного накопления и сбора отходов потребления или в пункт сбора использованной бытовой техники для последующей утилизации.

NA DOSIAHNUTIE PERFEKTNÝCH VÝSLEDKOV

Ďakujeme, že ste si vybrali tento výrobok značky AEG. Vytvorili sme ho, aby vám poskytol bezchybný výkon na mnoho rokov, pričom sme použili inovačné technológie, ktoré pomáhajú zjednodušovať život – funkcie, ktoré nenájdete u bežných spotrebičov. Venujte, prosím, niekoľko minút tomuto návodu a dôkladne si ho prečítajte, aby ste svoj spotrebič mohli využívať čo najlepšie.

Navštívte našu stránku, kde nájdete:



Rady týkajúce sa používania, brožúry, návody na riešenie problémov a informácie o servise a opravách:

www.aeg.com/support



Zaregistrujte si výrobok a využite tak ešte lepší servis:

www.registreaeg.com



Pre váš spotrebič si môžete zakúpiť príslušenstvo, spotrebný materiál a originálne náhradné diely:

www.aeg.com/shop

STAROSTLIVOSŤ O ZÁKAZNÍKA A ZÁKAZNÍCKY SERVIS

Vždy používajte originálne náhradné diely.

Ak potrebujete kontaktovať autorizované servisné stredisko, uistite sa, že máte k dispozícii nasledujúce údaje: Model, číslo výrobku, sériové číslo.

Tieto informácie nájdete na typovom štítku.

 Upozornenie / Výstražné a bezpečnostné informácie

 Všeobecné informácie a tipy

 Informácie o životnom prostredí

Vyhradzujeme si právo na zmeny bez predchádzajúceho upozornenia.

OBSAH

1. BEZPEČNOSTNÉ INFORMÁCIE.....	363	3. POPIS VÝROBKU.....	370
1.1 Bezpečnosť detí a zraniteľných osôb.....	363	3.1 Všeobecný prehľad.....	370
1.2 Všeobecná bezpečnosť.....	364	3.2 Príslušenstvo.....	370
2. BEZPEČNOSTNÉ POKYNY.....	366	4. AKO ZAPNÚŤ A VYPNÚŤ RÚRU.....	370
2.1 Montáž.....	366	4.1 Ovládací panel.....	370
2.2 Elektrické zapojenie.....	367	4.2 Displej.....	371
2.3 Použitie.....	368	5. PRED PRVÝM POUŽITÍM.....	372
2.4 Starostlivosť a čistenie.....	369	5.1 Prvé čistenie	373
2.5 Vnútorne osvetlenie.....	369	5.2 Prvé pripojenie.....	373
2.6 Servis.....	369		
2.7 Likvidácia.....	369		

6. KAŽDODENNÉ POUŽÍVANIE.....	373	10.4 Odporúčané nastavenia výkonu pre rôzne druhy jedla.....	383
6.1 Nastavenie funkcie: Gril + Mikrovlny, Gril.....	373	10.5 Tabuľky pečenia pre skúšobné inštitúty.....	384
6.2 Ako nastaviť: Funkcie ohrevu mikrovlnnej rúry.....	375	11. OŠETROVANIE A ČISTENIE.....	385
6.3 Spôsob používania: Rýchly štart mikrovlnnej rúry.....	376	11.1 Poznámky k čisteniu.....	385
6.4 Funkcie ohrevu.....	376	12. RIEŠENIE PROBLÉMOV.....	386
7. ČASOVÉ FUNKCIE.....	377	12.1 Čo robiť, ak.....	386
7.1 Popis časových funkcií.....	377	12.2 Ako postupovať: Poruchové kódy.....	387
7.2 Ako nastaviť: Časové funkcie.....	378	12.3 Servisné údaje.....	387
8. POUŽÍVANIE: PRÍSLUŠENSTVO.....	379	13. ENERGETICKÁ ÚČINNOSŤ.....	388
8.1 Vloženie príslušenstva.....	379	13.1 Úspora energie.....	388
9. DOPLNKOVÉ FUNKCIE.....	380	14. ŠTRUKTÚRA PONUKY.....	388
9.1 Ako uložiť: Obľúbené.....	380	14.1 Ponuka.....	388
9.2 Blokovanie ovládania.....	380	14.2 Podponuka pre: Voliteľné funkcie.....	388
9.3 Chladiaci ventilátor.....	381	14.3 Podponuka pre: Nastavenie.....	389
10. TIPY A RADY.....	381	14.4 Podponuka pre: Servis.....	389
10.1 Odporúčania pre varenie.....	381	15. JE TO JEDNODUCHÉ!.....	389
10.2 Odporúčania pre mikrovlnnú rúru.....	381	16. OCHRANA ŽIVOTNÉHO PROSTREDIA.....	391
10.3 Kuchynský riad a materiály vhodné do mikrovlnnej rúry.....	382		

1. BEZPEČNOSTNÉ INFORMÁCIE

Pred inštaláciou a používaním spotrebiča si pozorne prečítajte priložený návod na používanie. Výrobca nezodpovedá za zranenia ani za škody spôsobené nesprávnou montážou alebo používaním. Tieto pokyny uskladnite na bezpečnom a prístupnom mieste, aby ste do nich mohli v budúcnosti nahliadnuť.

1.1 Bezpečnosť detí a zraniteľných osôb

- Tento spotrebič smú používať deti staršie ako 8 rokov a osoby so zníženou fyzickou, zmyslovou alebo psychickou spôsobilosťou alebo nedostatkom skúseností a znalostí, iba ak sú pod dozorom zodpovednej osoby alebo ak boli zodpovednou osobou poučené o bezpečnom používaní spotrebiča a rozumejú prípadným rizikám. Deti do 8 rokov

a osoby s vysokou mierou postihnutia nesmú mať prístup k spotrebiču, pokiaľ nie sú pod nepretržitým dozorom.

- Deti by mali byť pod dozorom, aby sa zabezpečilo, že sa so spotrebičom nebudú hrať.
- Obaly vždy uschovajte mimo dosah detí a náležite ich zlikvidujte.
- **UPOZORNENIE:** Nedovoľte deťom ani domácim zvieratám priblížiť sa k spotrebiču počas prevádzky alebo keď sa ochladzuje. Prístupné časti sa počas používania zohrejú na vysokú teplotu.
- Ak má spotrebič detskú poistku, mala by byť zapnutá.
- Deti nesmú spotrebič bez dozoru čistiť ani vykonávať žiadnu údržbu na spotrebiči.

1.2 Všeobecná bezpečnosť

- Tento spotrebič je určený iba na prípravu jedál.
- Tento spotrebič je určený na jedno použitie v domácnosti v interiéri.
- Tento spotrebič sa môže používať v kanceláriách, hotelových hosťovských izbách, izbách s posteľou a raňajkami, v domovoch poľnohospodárskych hostí a iných podobných ubytovacích zariadeniach, ak takéto používanie nepresiahne (priemerné) úrovne používania v domácnosti.
- Nainštalovať tento spotrebič a vymeniť kábel smie iba na to kvalifikovaná osoba.
- Spotrebič nepoužívajte pred jeho nainštalovaním do nábytku určeného na zabudovanie.
- Pred akoukoľvek údržbou opojte spotrebič od elektrickej siete.
- Ak je poškodený elektrický napájací kábel, musíte ho dať vymeniť u výrobcu, v autorizovanom servisnom stredisku alebo u kvalifikovanej osoby, aby sa predišlo nebezpečenstvu.

- UPOZORNENIE: Uistite sa, že je pred výmenou osvetlenia spotrebič vypnutý, aby ste sa vyhli riziku elektrického šoku.
- UPOZORNENIE: Spotrebič a jeho prístupné časti sa počas používania môžu značne zahriať. Nedotýkajte sa ohrevných článkov.
- Vždy používajte na vyberanie a vkladanie príslušenstva alebo riadu kuchynské rukavice.
- Používajte iba otočný tanier a držiak otočného taniera navrhnutý pre tento spotrebič.
- Neaktivujte funkciu mikrovln, keď je spotrebič prázdny. Kovové časti vo vnútri dutiny môžu vytvárať elektrický oblúk.
- Kovové nádoby na potraviny a nápoje nie sú povolené na prípravu jedla v mikrovlnnej rúre. Táto požiadavka sa nevzťahuje na prípady, keď výrobca špecifikuje veľkosť a tvar kovových zásobníkov vhodných na prípravu jedla v mikrovlnnej rúre.
- UPOZORNENIE: Ak sú dvierka alebo ich tesnenie poškodené, spotrebič sa nesmie používať, kým ho neopraví kvalifikovaná osoba.
- UPOZORNENIE: Iba kvalifikovaná osoba môže vykonávať akékoľvek činnosti spojené so servisom alebo opravou, ktoré zahŕňajú odstránenie krytu poskytujúceho ochranu pred vystavením mikrovlnnej energii.
- UPOZORNENIE: Nezohrievajte tekutiny a iné potraviny v uzavretých nádobách. Môžu explodovať.
- Používajte výhradne kuchynské pomôcky vhodné na použitie v mikrovlnnej rúre.
- Ak zohrievate potraviny v plastových alebo papierových nádobách, majte spotrebič pod dohľadom, pretože môže dôjsť k vznieteniu.
- Spotrebič je určený na ohrev potravín a nápojov. Sušenie potravín alebo odevov a ohrev otepľovacích podložiek, papúč, špongií, vlhkej handry a podobných predmetov môže viesť k riziku zranenia, vznietenia alebo požiaru.

BEZPEČNOSTNÉ POKYNY

- Ak zo spotrebiča vychádza dym, vypnite ho alebo odpojte od elektrickej siete a nechajte dvierka zatvorené, aby došlo k uhaseniu prípadných plameňov.
- Ohrievanie nápojov v mikrovlnnej rúre môže mať za následok oneskorené prudké vrenie. Pri manipulácii s nádobou je potrebné postupovať opatrne.
- Obsah fliaš na kŕmenie a nádob s detskou výživou sa pred konzumáciou musí premiešať alebo pretrepať a musí sa skontrolovať teplota, aby sa zabránilo popáleniu.
- Vajcia v škrupine a celé vajcia uvarené natvrdo by sa nemali v spotrebiči ohrievať, pretože môžu explodovať, a to aj po ukončení mikrovlnného ohrevu.
- Spotrebič by mal byť pravidelne čistený a všetky zvyšky jedla odstránené.
- Na čistenie spotrebiča nepoužívajte parné čističe.
- Na čistenie skla dvierok nepoužívajte abrazívne prostriedky ani ostré kovové škrabky, pretože by mohli poškrabať povrch, čo môže spôsobiť rozbitie skla.
- Ak nebudete spotrebič udržiavať v čistom stave, mohlo by to viesť k znehodnoteniu jeho povrchu, čo by mohlo nepriaznivo ovplyvniť jeho životnosť a prípadne vyústiť do nebezpečnej situácie.

2. BEZPEČNOSTNÉ POKYNY

2.1 Montáž

**VAROVANIE!**

Tento spotrebič smie nainštalovať iba kvalifikovaná osoba.

- Odstráňte všetky obaly.
- Poškodený spotrebič neinštalujte ani nepoužívajte.
- Dodržiavajte pokyny na inštaláciu dodané so spotrebičom.
- Vždy dávajte pozor, ak presúvate spotrebič, pretože je ťažký. Vždy používajte ochranné rukavice a uzavretú obuv.
- Spotrebič neťahajte za rukoväť.
- Spotrebič nainštalujte na bezpečné a vhodné miesto, ktoré spĺňa požiadavky na inštaláciu.
- Dodržiavajte požadovanú minimálnu vzdialenosť od iných spotrebičov a nábytku.
- Pred namontovaním spotrebiča skontrolujte, či sa dvierka rúry otvárajú bez odporu.

- Spotrebič je vybavený elektrickým systémom chladenia. Ten musí byť napájaný z elektrickej siete.
- Vstavaná jednotka musí spĺňať požiadavky normy DIN 68930 na stabilitu.

Minimálna výška kuchynskej skrinky (minimálna výška skrinky pod pracovnou doskou)	444 (460) mm
Šírka kuchynskej skrinky	560 mm
Hĺbka kuchynskej skrinky	550 (550) mm
Výška prednej časti spotrebiča	455 mm
Výška zadnej časti spotrebiča	440 mm
Šírka prednej časti spotrebiča	595 mm
Šírka zadnej časti spotrebiča	559 mm
Hĺbka spotrebiča	567 mm
Hĺbka zabudovaného spotrebiča	546 mm
Hĺbka s otvorenými dvierkami	882 mm
Minimálna veľkosť vetracieho otvoru. Otvor umiestnený na spodnej zadnej strane	560x20 mm
Dĺžka napájacieho kábla. Kábel sa nachádza v pravom rohu na zadnej strane	1500 mm
Montážne skrutky	3.5x25 mm

2.2 Elektrické zapojenie



VAROVANIE!

Nebezpečenstvo požiaru a zásahu elektrickým prúdom.

- Všetky elektrické zapojenia by mal vykonať kvalifikovaný elektroinštalatér.
- Spotrebič musí byť uzemnený.
- Uistite sa, že parametre na typovom štítku sú kompatibilné s elektrickým napätím zdroja napájania.
- Vždy používajte správne nainštalovanú zásuvku odolnú proti nárazom.
- Nepoužívajte viaczásuvkové adaptéry ani predlžovacie káble.
- Uistite sa, že zástrčka a prívodný elektrický kábel nie sú poškodené. Ak prívodný elektrický kábel spotrebiča treba vymeniť, túto operáciu smie urobiť iba pracovník autorizovaného servisného strediska.

BEZPEČNOSTNÉ POKYNY

- Nedovoľte, aby sa napájacie elektrické káble dotkli alebo dostali do blízkosti dvierok spotrebiča alebo výklenku pod spotrebičom najmä vtedy, keď sú dvierka horúce.
- Zariadenie na ochranu pred dotykom elektrických častí pod napätím a izolovaných častí treba namontovať tak, aby sa nedalo odstrániť bez nástrojov.
- Sieťovú zástrčku pripojte do sieťovej zásuvky až po dokončení inštalácie. Po inštalácii sa uistite, že máte prístup k sieťovej zástrčke.
- Ak je sieťová zásuvka uvoľnená, nezapájajte do nej sieťovú zástrčku.
- Spotrebič neodpájajte ťahaním za napájací kábel. Vždy ťahajte za sieťovú zástrčku.
- Použite iba správne odpájacie zariadenia: ochranné ističe alebo poistky (skrutkovacie poistky treba vybrať z držiaka), uzemnenia a stýkače.
- Elektrická sieť v domácnosti musí mať odpájacie zariadenie, ktoré umožní odpojenie spotrebiča od elektrickej siete na všetkých póloch. Vzďialenosť kontaktov odpájacieho zariadenia musí byť minimálne 3 mm.
- Tento spotrebič sa dodáva s napájacou zástrčkou a napájacím káblom.

2.3 Použitie



VAROVANIE!

Hrozí nebezpečenstvo poranenia, popálenín, zásahu elektrickým prúdom alebo výbuchu.

- Nemeňte technické parametre tohto spotrebiča.
- Uistite sa, že nie sú otvory vetrania zablokované.
- Spotrebič počas prevádzky nenechávajte bez dozoru.
- Spotrebič po každom použití vypnite.
- Pri otváraní dvierok spotrebiča počas jeho prevádzky buďte opatrní. Môže z neho uniknúť horúci vzduch.
- Spotrebič neobsluhujte s mokrymi rukami alebo keď je v kontakte s vodou.
- Na otvorené dvierka nevyvíjate tlak.
- Spotrebič nepoužívajte ako pracovný alebo skladovací povrch.
- Dvierka spotrebiča otvárajte opatrne. Používanie prísad s alkoholom môže spôsobiť zmiešanie alkoholu a vzduchu.
- Pri otváraní dvierok zabráňte kontaktu iskier alebo otvoreného plameňa so spotrebičom.
- Horľavé látky ani predmety, ktoré sú nasiaknuté horľavými látkami, nekladte do spotrebiča, do jeho blízkosti ani naň.
- Nepoužívajte funkciu mikrovln na predhriatie rúry.



VAROVANIE!

Hrozí nebezpečenstvo poškodenia spotrebiča.

- Aby sa predišlo škode alebo zmene farby povrchovej úpravy:
 - Nedávajte priamo na dno dutiny spotrebiča alobal.
 - Nedávajte priamo do horúceho spotrebiča vodu.
 - Po ukončení prípravy pokrmu v rúre nenechávajte vlhký riad ani potraviny.
 - Pri odstraňovaní alebo inštalácii príslušenstva buďte opatrní.
- Zmena farby smaltu alebo ušľachtilej ocele nemá žiadny vplyv na výkon spotrebiča.
- Pri varení musia byť dvierka spotrebiča vždy zatvorené.
- Pri inštalácii spotrebiča za nábytkový panel (napr. dvere) zabezpečte, aby dvere neboli počas prevádzky spotrebiča nikdy zatvorené. Za zatvoreným nábytkovým panelom sa môže vytvoriť teplo a vlhkosť a môžu spôsobiť následné poškodenie spotrebiča, nábytku alebo podlahy. Nábytkový panel nezatvárajte, kým spotrebič po použití úplne nevychladne.

2.4 Starostlivosť a čistenie



VAROVANIE!

Hrozí nebezpečenstvo poranenia, požiaru alebo poškodenia spotrebiča.

- Pred vykonávaním údržby spotrebič vypnite a vytiahnite jeho zástrčku zo sieťovej zásuvky.
- Skontrolujte, či je spotrebič studený. Existuje riziko, že sklenené panely môžu prasknúť.
- Ak sú sklenené panely dvierok poškodené, bezodkladne ich nechajte vymeniť. Obráťte sa na autorizované servisné stredisko.
- Pri vyberaní dvierok zo spotrebiča postupujte opatrne. Dvierka sú ťažké!
- Po každom použití utrite dutinu rúry, otočný tanier a dvierka dosucha. Para vytvorená počas prevádzky spotrebiča kondenzuje na stenách dutiny a môže spôsobiť koróziu.
- Spotrebič pravidelne čistite, aby ste predišli znehodnoteniu povrchového materiálu.
- Zvyšky tuku alebo potravín v spotrebiči môžu pri mikrovlňnej prevádzke spôsobiť požiar a elektrické iskrenie.
- Spotrebič čistite vlhkou mäkkou handričkou. Používajte iba neutrálne saponáty. Nepoužívajte abrazívne výrobky, špongie s abrazívnou vrstvou, rozpúšťadlá ani kovové predmety.
- Ak používate sprej na čistenie rúr, dodržiavajte bezpečnostné pokyny na jeho obale.

2.5 Vnútorne osvetlenie



VAROVANIE!

Hrozí nebezpečenstvo zásahu elektrickým prúdom.

- Informácie o žiarovke/žiarovkách vnútri tohto výrobku a náhradných dieloch osvetlenia, ktoré sa predávajú samostatne: Tieto žiarovky sú navrhnuté tak, aby odolali extrémnym podmienkam v domácich spotrebičoch, ako napr. teplota, vibrácie, vlhkosť, alebo slúžia ako ukazovatele prevádzkového stavu spotrebiča. Nie sú určené na používanie iným spôsobom a nie sú vhodné na osvetlenie priestorov v domácnosti.
- Tento výrobok obsahuje svetelný zdroj triedy energetickej účinnosti G.
- Používajte iba žiarovky s rovnakými technickými parametrami .

2.6 Servis

- Ak treba dať spotrebič opraviť, obráťte sa na autorizované servisné stredisko.
- Používajte iba originálne náhradné diely.

2.7 Likvidácia



VAROVANIE!

Hrozí nebezpečenstvo poranenia alebo udusenía.

- O likvidácii spotrebiča sa informujte na mestskom alebo obecnom úrade.
- Spotrebič odpojte od elektrickej siete.
- Prívodný elektrický kábel odrežte blízko pri spotrebiči a zlikvidujte ho.
- Odstráňte západku dvierok, aby ste zabránili uviaznutiu alebo domácich zvierat v spotrebiči.

3. POPIS VÝROBKU

3.1 Všeobecný prehľad

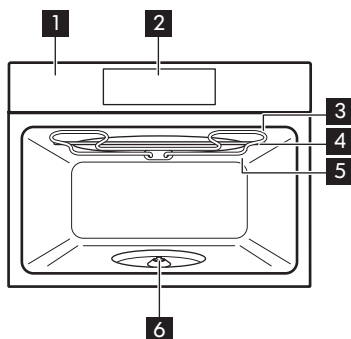

- 1** Ovládací panel
- 2** Displej
- 3** Ohrevný prvok
- 4** Generátor mikrovlnnej rúry
- 5** Osvetlenie

- 6** Hriadeľ otočného taniera

3.2 Príslušenstvo

Komplet turntable
Na prípravu jedla.

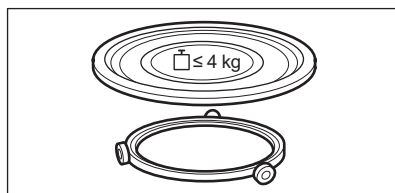

Komplet roštov na gril
Na grilovanie.

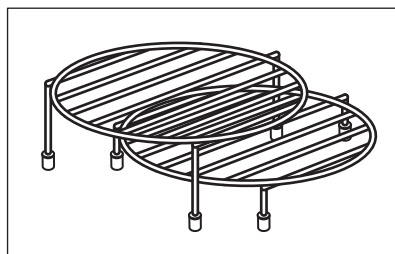

4. AKO ZAPNÚŤ A VYPNÚŤ RÚRU

4.1 Ovládací panel

AKO ZAPNÚŤ A VYPNÚŤ RÚRU

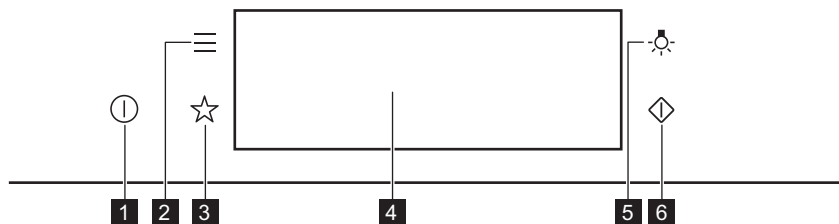



1	ZAP. / VYP.	Stlačte a podržte na zapnutie a vypnutie rúry.
2	Ponuka	Zoznam funkcií rúry.
3	Oblíbené	Zoznam obľúbených nastavení.
4	Displej	Zobrazuje aktuálne nastavenia rúry.
5	Spínač osvetlenia	Zapnutie a vypnutie osvetlenia.
6	Rýchly štart mikrovlnnej rúry	Zapnutie funkcie mikrovln (1 000 W a 30 sekúnd).

<p>Stláčajte</p>	<p>Presunutie</p>	<p>Stlačte a podržte tlačidlo</p>
Dotknite sa povrchu končekom prsta.	Posuňte konček prsta po povrchu.	Dotknite sa povrchu na 3 sekundy.

4.2 Displej



<p>The diagram shows a display area with the following elements: '300W' (power), a light bulb icon (light), a menu icon (three horizontal lines), 'High' (intensity), '12:34' (time), and 'START' (button). Labels F, E, D, C, and B are placed below the light, 300W, menu icon, High, and START respectively. Label A is placed above the time display.</p>	<p>Po zapnutí sa na displeji zobrazí hlavná obrazovka s funkciou ohrevu a pôvodným nastavením intenzity grilu.</p> <p>A. Presný čas B. ŠTART/STOP C. Intenzita grilu D. Funkcie ohrevu E. Výkon mikrovlnnej rúry F. Časovač</p>
---	--

PRED PRVÝM POUŽITÍM

 12:34	Ak rúru nepoužívate 2 minúty, displej sa prepne do pohotovostného režimu.
1000W  1m23s +30s STOP	Keď pečiete, na displeji sa zobrazujú nastavené funkcie a ostatné dostupné voliteľné funkcie.

Ukazovatele na displeji



Základné ukazovatele – na navigáciu na displeji.

OK Potvrdenie výberu/nastavenia.	 Návrat o jednu úroveň v ponuke.	 Vrátenie posledného úkonu.	 Zapnutie a vypnutie voliteľných funkcií.
--	--	---	---

Ukazovatele funkcie Zvukový signál – keď uplynie nastavený čas prípravy pokrmu, zaznie zvukový signál.

 Funkcia je zapnutá.	 Funkcia je zapnutá. Varenie sa automaticky zastaví.	 Zvukový signál je vypnutý.
--	---	---

Ukazovatele časovača

 Nastavenie funkcie: Odložený štart.	 Ak chcete zrušiť nastavenia.
--	---



5. PRED PRVÝM POUŽITÍM



VAROVANIE!

Pozrite si kapitoly ohľadne bezpečnosti.

5.1 Prvé čistenie

		
Krok č. 1	Krok č. 2	Krok č. 3
Vyberte všetko príslušenstvo z rúry.	Rúru a jej príslušenstvo potierajte vlhkou handrou namočenou vo vlažnej vode s miernym čistiacim prostriedkom.	Príslušenstvo vložte do rúry.

5.2 Prvé pripojenie

Na displeji sa po prvom pripojení zobrazí uvítacie hlásenie. Musíte nastaviť: Jazyk, Jas displeja, Tóny tlačidiel, Hlasitosť zvuku, Presný čas.

6. KAŽDODENNÉ POUŽÍVANIE



VAROVANIE!

Pozrite si kapitoly ohľadne bezpečnosti.

6.1 Nastavenie funkcie: Gril + Mikrovlny, Gril

Rúra môže vydávať zvuky pri použití funkcie: Gril + Mikrovlny. Sú to bežné zvuky pre túto funkciu.

Nastavenie funkcie: Gril + Mikrovlny	
Krok č. 1	Vložte dolný grilovací rošt.
Krok č. 2	Zapnite rúru. Na displeji sa zobrazí predvolená funkcia ohrevu.
Krok č. 3	Stlačte symbol funkcie ohrevu, aby ste vstúpili do podponuky.
Krok č. 4	Zvoľte funkciu:  . Stlačte tlačidlo: OK.
Krok č. 5	Zvoľte úroveň intenzity grilu.
Funkcia	Úroveň intenzity grilu

KAŽDODENNÉ POUŽÍVANIE

Nastavenie funkcie: Gril + Mikrovlny	
Lo	Nízka
Hi	Vysoká
Krok č. 6	Stlačte tlačidlo: OK.
Krok č. 7	Stlačte tlačidlo: START .
STOP – stlačte, ak chcete vypnúť rúru.	
Krok č. 8	Vypnite rúru.

Mikrovlnný výkon je obmedzený na 500 W, keď použijete funkciu: Gril + Mikrovlny.

Nastavenie funkcie: Gril	
Krok č. 1	Vložte horný grilovací rošt.
Krok č. 2	Zapnite rúru. Na displeji sa zobrazí predvolená funkcia ohrevu.
Krok č. 3	Stlačte symbol funkcie ohrevu, aby ste vstúpili do podponuky.
Krok č. 4	Zvoľte funkciu:  . Stlačte tlačidlo: OK.
Krok č. 5	Zvoľte úroveň intenzity grilu.
Funkcia	Úroveň intenzity grilu
Lo	Nízka
Hi	Vysoká
Krok č. 6	Stlačte tlačidlo: OK.

Nastavenie funkcie: Gril	
Krok č. 7	Stlačte tlačidlo: START .
Funkciu vypnete stlačením STOP .	
Krok č. 8	Vypnite rúru.

6.2 Ako nastaviť: Funkcie ohrevu mikrovlnnej rúry

Krok č. 1	Zapnite rúru.
Krok č. 2	Stlačte symbol funkcie ohrevu, aby ste vstúpili do podponuky.
Krok č. 3	Vyberte funkciu ohrevu mikrovlnami a stlačte: OK. Na displeji sa zobrazí: mikrovlnný výkon.
Krok č. 4	Nastavte mikrovlnný výkon. Stlačte tlačidlo: OK.
Krok č. 5	Stlačte tlačidlo: START .
Funkciu vypnete stlačením STOP .	
Krok č. 6	Vypnite rúru.

Maximálny nastavený čas funkcie mikrovln závisí od výkonu, ktorý nastavíte:

MIKROVLNNÝ VÝKON	MAXIMÁLNY ČAS
100 – 600 W	59 minút
Viac ako 600 W	7 minút



Ak otvoríte dverka, funkcia sa vypne. Pre opakované spustenie stlačte START .

Použite skratku!





6.3 Spôsob používania: Rýchly štart mikrovlnnej rúry





Krok č. 1	Stlačte a podržte tlačidlo: ⏻. Mikrovlnná rúra sa spustí na 30 sekúnd.	
Krok č. 2	Predlžuje čas pečenia:	
	Stlačením prebiehajúcej časovej hodnoty sa dostanete na nastavenia času. Nastavte čas pečenia.	Stlačte +30 s.
Mikrovlnnú rúru môžete kedykoľvek zapnúť pomocou: Rýchly štart mikrovlnnej rúry.		

6.4 Funkcie ohrevu

ŠTANDARDNÉ

Funkcia ohrevu	Aplikácia
 Gril	Na grilovanie tenkých kusov jedla a na prípravu hriankov.
 Gril + Mikrovlny	Na rýchlu prípravu jedla a zapekanie. Môžete nastaviť 2 úrovne intenzity grilu: nízku a vysokú.
 Mikrovlnná rúra	Zohrievanie, varenie, rozsah výkonu: 100 – 1 000 W

MIKROVLNNÁ RÚRA

Funkcia ohrevu	Aplikácia
 Rozmrazovanie	Rozmrazovanie mäsa, rýb, koláčov, rozsah výkonu: 100 – 200 W
 Roztopenie	Rozpustenie čokolády a masla, rozsah výkonu: 100 – 400 W
 Zohrievanie	Ohrev vopred pripravených a drobných pokrmov, rozsah výkonu: 300 – 700 W
 Popcorn	Príprava popcornu, rozsah výkonu: 700 – 1 000 W
 Tekutina	Zohrievanie nápojov a polievok, rozsah výkonu: 800 – 1 000 W

7. ČASOVÉ FUNKCIE

7.1 Popis časových funkcií

Funkcia časovača	Aplikácia
Čas prípravy	Nastavenie dĺžky varenia. Maximálne 23 h 59 min.
Kritéria skončenia	Nastavenie, čo sa má stať, keď časovač skončí odpočítavanie.
Predĺženie pečenia	Predĺženie času varenia.
Pripomienka	Slúži na nastavenie odpočítavania času. Maximálne 23 h 59 min. Táto funkcia nemá vplyv na činnosť rúry.
Časovač	Sleduje, ako dlho je funkcia v činnosti. Časovač – môžete ju zapnúť a vypnúť.

7.2 Ako nastaviť: Časové funkcie

Nastavenie hodín	
Krok č. 1	Stlačte tlačidlo: Presný čas.
Krok č. 2	Nastavte čas. Stlačte tlačidlo: OK.

Nastavenie času varenia	
Krok č. 1	Zvoľte funkciu ohrevu.
Krok č. 2	Stlačte tlačidlo:  .
Krok č. 3	Nastavte čas. Stlačte tlačidlo: OK.

Výber funkcie koniec	
Krok č. 1	Zvoľte funkciu ohrevu.
Krok č. 2	Stlačte tlačidlo:  .
Krok č. 3	Nastavte čas varenia.
Krok č. 4	Stlačte tlačidlo: ● ● ● .
Krok č. 5	Stlačte tlačidlo: Kritéria skončenia.
Krok č. 6	Zvoľte požadované: Kritéria skončenia.
Krok č. 7	Stlačte tlačidlo: OK. Úkon opakujte, kým sa na displeji nezobrazí hlavná obrazovka.

Predĺženie času varenia

Keď zostáva 10 % času varenia a jedlo sa nezdá byť hotové, môžete predĺžiť čas varenia. Môžete tiež zmeniť funkciu ohrevu.

Stláčaním **+ 1 min** predĺžite čas varenia.

Zmena nastavení časovača

Krok č. 1 Stlačte tlačidlo: 

Krok č. 2 Nastavte hodnotu časovača.

Krok č. 3 Stlačte tlačidlo: **OK**.

Nastavený čas môžete zmeniť kedykoľvek počas varenia.

8. POUŽÍVANIE: PRÍSLUŠENSTVO

8.1 Vloženie príslušenstva

Používajte iba vhodný kuchynský riad a materiál. Pozrite si Kuchynský riad a materiály vhodné pre mikrovlnnú rúru v kapitole „Tipy a rady“.

Komplet turntable:

Jedlo vždy pripravujte na súprave otočného taniera.

Umiestnite vodiaci kruh okolo hriadeľa otočného taniera. Otočný sklenený tanier umiestnite na vodiaci kruh.

Používajte iba súpravu otočného taniera dodanú s rúrou.

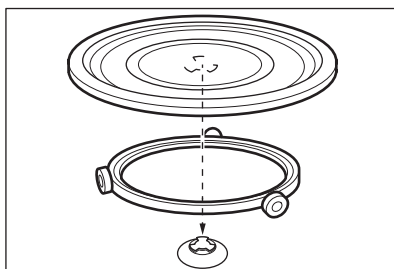

DOPLNKOVÉ FUNKCIE

Komplet roštov na gril:

Grilovací rošt postavte so silikónovými päťkami dole na súpravu otočného taniera.

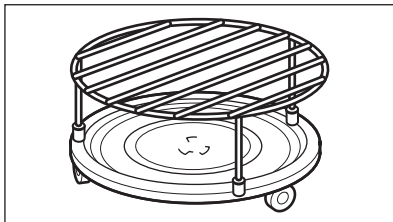

9. DOPLNKOVÉ FUNKCIE

9.1 Ako uložiť: Obľúbené



Môžete uložiť svoje obľúbené nastavenia, ako napr. funkciu ohrevu, čas prípravy pokrmu alebo funkciu čistenia. Môžete uložiť 3 obľúbené nastavenia.

Krok č. 1	Zapnite rúru.
Krok č. 2	Vyberte preferované nastavenie.
Krok č. 3	Stlačte tlačidlo:  . Vyberte: Obľúbené.
Krok č. 4	Vyberte možnosť: Uložiť aktuálne nastavenia.
Krok č. 5	Stlačte +, aby ste pridali nastavenie do zoznamu: Obľúbené. Stlačte tlačidlo OK.
↶ – stlačte, ak chcete obnoviť nastavenie. ⊗ – stlačte, ak chcete zrušiť nastavenie.	

9.2 Blokovanie ovládania

Táto funkcia predchádza náhodnej zmene funkcie ohrevu.

Krok č. 1	Zapnite rúru.
Krok č. 2	Nastavte funkciu ohrevu.

Krok č. 3	Stlačte súčasne  a  , aby ste zapli funkciu.
Ak chcete blokovanie ovládania vypnúť, zopakujte krok 3.	

9.3 Chladiaci ventilátor

Ak je rúra zapnutá, automaticky sa aktivuje chladiaci ventilátor, aby udržal povrch rúry chladný. Ak vypnete rúru, chladiaci ventilátor môže zostať v činnosti, kým rúra nevychladne.

10. TIPY A RADY

10.1 Odporúčania pre varenie

<p>Teploty a časy prípravy jedál uvedené v tabuľkách sú iba orientačné. Závisia od konkrétneho receptu a množstva a kvality použitých prísad.</p> <p>Vaša rúra môže pri pečení fungovať inak ako rúra, ktorú ste používali doteraz. Rady nižšie zobrazujú odporúčané funkcie ohrevu a nastavenia času pečenia pre konkrétne typy jedál.</p> <p>Ak nie je k dispozícii nastavenie pre konkrétny recept, vyhľadajte nastavenie pre podobný recept. Viac odporúčaní týkajúcich sa pečenia nájdete v tabuľkách pečenia na našej webovej lokalite. Pri hľadaní tipov pre pečenie budete potrebovať číslo výrobku (PNC) uvedené na typovom štítku na prednom ráme dutiny rúry.</p>

10.2 Odporúčania pre mikrovlnnú rúru

Podme variť!

Jedlo nekladte priamo na otočný tanier. Vždy použite riad vhodný do mikrovlnnej rúry. Kuchynský riad položte do stredu otočného taniera.

Kontakt s príliš horúcimi alebo chladnými predmetmi môže spôsobiť prasknutie otočného taniera.

V polovici rozmrazovania otočte jedlo na druhú stranu alebo premiešajte.

Tekuté pokrmy občas premiešajte.

Jedlo pred podávaním premiešajte.

Jedlo pred prípravou a zohrievaním prikryte.

Pri ohreve nápojov vložte do fľaše alebo pohára lyžicu, aby ste zabezpečili lepšiu distribúciu tepla.

Potraviny vkladajte do rúry bez obalu. Hotové balené jedlá môžete vložiť do rúry iba keď je obal vhodný pre mikrovlnnú rúru (pozrite si informácie na obale).



Varenie v mikrovlnnej rúre

Jedlo varte prikryté. Ak chcete vytvoriť chrumkavú kôrku, jedlo varte odkryté.

Riad neprevarte príliš vysoko nastavením výkonu a času. Jedlo môže vyschnúť, prihorieť alebo spôsobiť požiar.

Rúru nepoužívajte na varenie vajčiek v škrupine ani slimákov v ulite, pretože by mohli vybuchnúť. Žltok alebo volské oká pred ohrevom prepichnete.

Jedlo so šupkou alebo kožou pred varením poprepichujte vidličkou.

Zeleninu pokrájajte na rovnako veľké kusy.

Po vypnutí rúry vyberte jedlo a nechajte ho niekoľko minút odstáť, aby sa teplo rovnomerne rozpýtľilo.



Rozmrazovanie v mikrovlnnej rúre

Zmrazený pokrm rozbaľte a položte na malý tanier obrátený hore dnom vložený do nádoby na zachytávanie odmrázenej vody, prípadne použite rozmrazovací rošt alebo plastové cedidlo, aby mohla voda odtekať.





Následne rozmrazené kusky odoberte.





Ak chcete uvariť mrazené ovocie a zeleninu, zvoľte vyšší mikrovlnný výkon a nemusíte ich vopred rozmrazovať.

10.3 Kuchynský riad a materiály vhodné do mikrovlnnej rúry

Používajte iba kuchynský riad a materiály vhodné do mikrovlnnej rúry. Použite tabuľku nižšie ako referenciu.



Pred použitím skontrolujte technické údaje kuchynského riadu/materiálu.

Kuchynský riad/materiál				
Sklo a porcelán vhodné na použitie v rúre bez kovových prvkov, napr. teplovzdorné sklo	✓	✓	✓	✓
Sklo a porcelán nevhodné na použitie v rúre bez striebra, zlata, platiny alebo iných kovových ozdôb	✓	X	X	X
Sklo a sklokeramika vyrobené z materiálu vhodného na použitie v rúre/mrazuvzdorného materiálu	✓	✓	✓	✓
Keramický a hlinený riad bez kremeňových alebo kovových prvkov a glazúry, ktoré obsahujú kov	✓	✓	X	X
Kuchynský riad vyrobený z porcelánu, keramiky alebo hliny, ktorý má neglazovaný spodok alebo drobné otvory, napr. na rukovätiach	X	X	X	X







Kuchynský riad/materiál				
Teplovzdorný plast až do 200 °C	✓	✓	X	X
Kartón, papier	✓	X	X	X
Potravinová fólia	✓	X	X	X
Fólia na pečenie s uzáverom vhodným pre mikrovlnné rúry	✓	✓	X	X
Nádoby na pečenie vyrobené z kovu, napr. smaltu, zliatiny	X	X	✓	X
Formy na pečenie, s čiernym lakom alebo silikónovou vrstvou	X	X	✓	X
Kuchynský riad vhodný do mikrovlnnej rúry, napr. zapekací pekáč	X	✓	X	X
Komplet roštov na gril	X	X	✓	✓



10.4 Odporúčané nastavenia výkonu pre rôzne druhy jedla





Údaje v tabuľke sú len referenčné.

800 – 1 000 W	
 <p>Prudké opekanie na začiatku procesu prípravy pokrmu</p>	 <p>Ohrievanie tekutín</p>

TIPY A RADY

500 – 700 W					
 Príprava zeleniny	 Príprava jedál s vajíčkami	 Pomaly varené dusené jedlá	 Pomalé varenie ryže	 Ohrievanie jedál na jednom tanieri	 Rozmrazovanie a ohrievanie mrazených jedál





300 – 400 W		
 Roztápanie syru, čokolády, masla	 Varenie/ohrev chúlостivých jedál	 Pokračovanie v príprave jedál





100 – 200 W				
 Ohrievanie jedál pre kojencov	 Rozmrazovanie chleba	 Rozmrazovanie ovocia a koláčov	 Rozmrazovanie syra, smotany, masla	 Rozmrazovanie mäsa, rýb

10.5 Tabuľky pečenia pre skúšobné inštitúty





Informácie pre skúšobné ústavy

Testy podľa normy IEC 60705.

FUNKCIA MIKROVLNNEJ RÚRY	 POWER (W)	 (kg)		 (min)	
Piškótový koláč	600	0.475	Komplet turntable	5 - 7	-
Fašírka	500	0.9	Komplet turntable	18 - 20	-
Vaječný nákyp	500	1	Komplet turntable	15 - 17	-

FUNKCIA MIKROVLNNEJ RÚRY	 (W)	 (kg)		 (min)	
Rozmrazovanie mäsa	200	0.5	Komplet turntable	8 - 9	-

Použitie funkcie: Mikrovlnný gril.
Použite dolný grilovací rošt.

KOMBINOVANÁ FUNKCIA MIKROVLNNEJ RÚRY	 (W)	 Úroveň intenzity grilu	 (min)	
Zapečené zemiaky, 1,1 kg	300	nízka	30 - 35	-
Kurča, 1,1 kg	300	vysoká	30 - 35	Mäso vložte do okrúhlej sklenenej nádoby.



11. OŠETROVANIE A ČISTENIE



VAROVANIE!

Pozrite si kapitoly ohľadne bezpečnosti.

11.1 Poznámky k čisteniu



 Čistiace prostriedky	Prednú stranu rúry očistite mäkkou tkaninou namočenou v teplej vode s prídavkom čistiaceho prostriedku.
	Na čistenie kovových povrchov použite čistiaci roztok.
	Škrvny vyčistite s miernym čistiacim prostriedkom.
 Každodenné používanie	Dutinu očistite po každom použití. Hromadenie tuku alebo iných zvyškov môže mať na následok vznik požiaru. Strop rúry opatrne vyčistite od zvyškov jedla a tuku.
	Jedlo v rúre neskladujte dlhšie ako 20 minút. Dutinu po každom použití vysušte jemnou handričkou.



	<p>Po každom použití vyčistite všetko príslušenstvo a nechajte ho uschnúť. Pred čistením počkajte, kým otočný tanier vychladne. Hrozí riziko, že otočný tanier môže prasknúť. Použite mäkkú handričku namočenú v teplej vode s jemným čistiacim prostriedkom. Príslušenstvo sa nesmie umývať v umývačke riadu.</p>
<p>Príslušenstvo</p>	<p>Nelepivé príslušenstvo nečistite abrazívnymi čistiacimi prostriedkami ani predmetmi s ostrými hranami.</p>

12. RIEŠENIE PROBLÉMOV

	<p>VAROVANIE! Pozrite si kapitoly ohľadne bezpečnosti.</p>
--	---



12.1 Čo robiť, ak...

 Rúra sa nezapne ani sa nezohrieva	
 Možná príčina	 Náprava
<p>Rúra nie je pripojená k zdroju elektrického napájania alebo je pripojená nesprávne.</p>	<p>Skontrolujte, či je rúra správne pripojená k zdroju elektrického napájania.</p>
<p>Hodiny nie sú nastavené.</p>	<p>Nastavte hodiny, podrobnosti nájdete v časti Nastavenie v kapitole „Časové funkcie“: Časové funkcie.</p>
<p>Dvierka nie sú správne zatvorené.</p>	<p>Dvierka úplne zatvorte.</p>
<p>Je vypálená poistka.</p>	<p>Skontrolujte, či je príčinou poruchy poistka. Ak sa problém objaví znovu, kontaktujte kvalifikovaného elektrikára.</p>
<p>Je zapnutá detská poistka rúry.</p>	<p>Pozrite si kapitolu „Ponuka“, podkapitoly: Voliiteľné funkcie.</p>

 Komponenty	
 Popis	 Náprava
Žiarovka je vypálená.	Žiarovku vymeňte, bližšie informácie nájdete v časti Výmena v kapitole „Starostlivosť a čistenie“: Osvetlenie.
Otočný tanier vydáva zvuky.	Pod otočným tanierom sú zvyšky jedla.

12.2 Ako postupovať: Poruchové kódy

Keď sa vyskytne softvérová chyba, na displeji sa zobrazí chybové hlásenie. V tejto časti nájdete zoznam problémov, ktoré môžete vyriešiť sami.

 Kód a popis	 Riešenie
F240, F439 – dotykové polia na displeji nefungujú správne.	Vyčistite povrch displeja. Uistite sa, že nie sú na dotykových poliach žiadne nečistoty.
F908 – systém rúry sa nedokáže pripojiť k ovládaciemu panelu.	Rúru vypnite a znova zapnite.

12.3 Servisné údaje

Ak problém nedokážete odstrániť sami, kontaktujte vášho predajcu alebo autorizované servisné stredisko.

Údaje potrebné pre autorizované servisné stredisko nájdete na typovom štítku. Typový štítok sa nachádza na prednom ráme dutiny rúry. Neodstraňujte typový štítok z dutiny rúry.

Odporúčame vám, aby ste vyplnili nasledujúce údaje:	
Model (MOD.)
Číslo produktu (PNC)
Sériové číslo (S.N.)

13. ENERGETICKÁ ÚČINNOSŤ

13.1 Úspora energie



Rúra má funkcie, ktoré vám pomôžu usporiť energiu pri každodennom varení.

Uistite sa, že dvierka rúry sú počas jej prevádzky zatvorené. Počas pečenia dvierka rúry neotvárajte príliš často. Tesnenie dvierok udržiavajte čisté a uistite sa, že je upevnené na svojom mieste.

Ak je to možné, rúru pred pečením nepredhrievajte.

Keď pripravujete niekoľko pokrmov naraz, zachovajte čo najkratšie prestávky medzi pečením.

Pečenie s vypnutým osvetlením

Počas pečenia vypnite osvetlenie. Zapnite ho iba v prípade potreby.

14. ŠTRUKTÚRA PONUKY

14.1 Ponuka

Stlačte tlačidlo , aby ste otvorili Ponuka.

Položka ponuky		Aplikácia
Obľúbené		Zoznam obľúbených nastavení.
Voliteľné funkcie		Nastavenie konfigurácie rúry.
Nastavenia	Nastavenie	Nastavenie konfigurácie rúry.
	Servis	Zobrazenie verzie softvéru a konfigurácie.

14.2 Podponuka pre: Voliteľné funkcie

Podponuka	Aplikácia
Osvetlenie rúry	Zapína a vypína lampu.
Detická poistka	Zabraňuje náhodnému zapnutiu rúry. Keď je táto voliteľná funkcia zapnutá, po zapnutí rúry sa na displeji zobrazí nápis „Detická poistka“. Na zapnutie používania rúry vyberte písmenú kódu v abecednom poradí. Prístup k časovaču, diaľkovému ovládaniu a osvetleniu je možný so zapnutou detskou poistkou.
Časové údaje	Zapnutie a vypnutie hodín.

Podponuka	Aplikácia
Formát digitálnych hodín	Zmena formátu zobrazenia času.

14.3 Podponuka pre: Nastavenie

Podponuka	Popis
Jazyk	Nastavenie jazyka rúry.
Jas displeja	Nastavenie jasú displeja.
Tóny tlačidiel	Zapnutie a vypnutie tónu dotýkových polí. Nie je možné stlmiť hlasitosť tónu pre: Ⓛ.
Hlasitosť zvuku	Nastavenie hlasitosti tónov tlačidiel a signálov.
Presný čas	Nastavenie aktuálneho času a dátumu.

14.4 Podponuka pre: Servis





Podponuka	Popis
Režim Demo	Aktivačný/deaktivačný kód: 2468
Verzia softvéru	Informácie o verzii softvéru.
Zrušiť všetky nastavenia	Obnovte nastavenia z výroby.

15. JE TO JEDNODUCHÉ!

Pred prvým použitím musíte nastaviť:				
Jazyk	Jas displeja	Tóny tlačidiel	Hlasitosť zvuku	Presný čas



JE TO JEDNODUCHÉ!

Oboznámte sa so základnými ikonami na ovládacom paneli a displeji:

 ZAP. / VYP.	 Ponuka	 Oblíbené	 Časovač	START / STOP
--	---	---	--	--------------



Začatie používania rúry

Rýchle zapnutie MW	Spustíte mikrovlnnú rúru kedykoľvek s predvolenými nastaveniami: 30 s/1000 W.	Stlačte tlačidlo: 
---------------------------	---	---

			
ohrev/príprava 100 – 1 000 W	príprava/opekanie intenzita: nízka/vysoká	príprava/opekanie	ohrievanie tekutín 800 – 1 000 W
			
zohrievanie 300 – 700 W	rozmrazovanie 100 – 200 W	topenie 100 – 400 W	príprava pukancov 700 – 1 000 W

Nastavenia mikrovlnnej rúry		Tipy pre mikrovlnnú rúru
Výkon mikrovlnnej rúry:	Maximálny čas:	Jedlo pred prípravou a zohrievaním prikryte. V polovici rozmrazovania otočte jedlo na druhú stranu alebo premiešajte. Pri ohrievaní tekutín vložte do pokrmu lyžičku. Potraviny vkladajte do rúry bez obalu (len bezpečného na použitie v mikrovlnnej rúre).
100 – 600 W	59 min	
> 600 W	7 min	

Spustiť varenie

Krok č. 1	Krok č. 2	Krok č. 3	Krok č. 4	Krok č. 5
 – stlačením tlačidla zapnete rúru.	 ... – zvolíte funkciu.	W – nastavte mikrovlnný výkon.	OK – nastavenie potvrdíte stlačením tlačidla.	START – stlačením tlačidla spustíte varenie.



Použité rýchle funkcie na nastavenie času varenia

10 % sprievodca dokončením

Použite 10 % sprievodcu dokončením na predĺženie doby varenia keď zostáva 10 % času varenia.

Na predĺženie času varenia stlačte **+ 1 min.**

16. OCHRANA ŽIVOTNÉHO PROSTREDIA

Materiály označené symbolom  odovzdajte na recykláciu. Obal hodte do príslušných kontajnerov na recykláciu. Chráňte životné prostredie a zdravie ľudí a recyklujte odpad z elektrických a elektronických spotrebičov. Nelikvidujte spotrebiče označené symbolom  spolu s odpadom z domácnosti. Výrobok odovzdajte v miestnom recyklačnom zariadení alebo sa obráťte na obecný alebo mestský úrad.

ДЛЯ ВІДМІННИХ РЕЗУЛЬТАТІВ

Дякуємо, що вибрали цей виріб AEG. Ми створили його для бездоганної роботи протягом багатьох років, за інноваційними технологіями, які допомагають робити життя простішим — такі властивості можна й не знайти у звичайних приладах. Прیدіліть декілька хвилин, щоби прочитати відомості, які допоможуть використовувати його максимально ефективно. Відвідайте наш веб-сайт, щоби:



Отримати поради з використання, брошури, інструкції з усунення несправностей, інформацію щодо сервісу та ремонту:

www.aeg.com/support



Зареєструвати свій продукт для кращого обслуговування:

www.registeraeg.com



Придбати аксесуари, витратні матеріали й оригінальні запчастини для вашого приладу:

www.aeg.com/shop

ДОПОМОГА КЛІЄНТАМ ТА ОБСЛУГОВУВАННЯ

Використовуйте лише оригінальні запасні частини. Звертаючись до нашого авторизованого сервісного центру, необхідно мати таку інформацію: модель, номер виробу, серійний номер. Інформацію можна знайти на таблиці з технічними даними.

 Попередження / Важлива інформація про безпеку

 Загальна інформація та рекомендації

 Інформація щодо захисту навколишнього середовища

Може змінитися без оповіщення.

ЗМІСТ

1. ІНФОРМАЦІЯ З ТЕХНІКИ БЕЗПЕКИ....	393	4. УВІМКНЕННЯ ТА ВИМКНЕННЯ ДУХОВОЇ ШАФИ.....	401
1.1 Безпека дітей і вразливих осіб..	393	4.1 Панель керування.....	401
1.2 Загальна безпека.....	394	4.2 Дисплей.....	402
2. ІНСТРУКЦІЇ З ТЕХНІКИ БЕЗПЕКИ.....	397	5. ПЕРЕД ПЕРШИМ ВИКОРИСТАННЯМ. 403	
2.1 Встановлення.....	397	5.1 Первинне очищення	404
2.2 Підключення до електромережі	398	5.2 Перше підключення.....	404
2.3 Користування.....	398	6. ЩОДЕННЕ КОРИСТУВАННЯ.....	404
2.4 Догляд і чищення.....	399	6.1 Налаштування функції: Гриль +	
2.5 Внутрішня підсвітка.....	400	МХ, Гриль.....	404
2.6 Сервіс.....	400	6.2 Налаштування: Мікрохвильові	
2.7 Утилізація.....	400	функції нагріву.....	406
3. ОПИС ВИРОБУ.....	401	6.3 Спосіб використання: Швидкий	
3.1 Загальний огляд.....	401	старт мікрохвильової печі.....	406
3.2 Аксесуари.....	401		

6.4 Функції нагрівання.....	407	10.5 Таблиці приготування їжі для дослідницьких установ.....	414
7. ФУНКЦІЇ ГОДИННИКА.....	408	11. ДОГЛЯД ТА ЧИСТКА.....	415
7.1 Опис функцій годинника.....	408	11.1 Примітки щодо чищення.....	416
7.2 Налаштування: Функції годинника.....	408	12. УСУНЕННЯ ПРОБЛЕМ.....	416
8. СПОСІБ ВИКОРИСТАННЯ: АКСЕСУАРИ.....	410	12.1 Дії в разі виникнення проблем	416
8.1 Встановлення аксесуарів.....	410	12.2 Як керувати: Коды помилок....	417
9. ДОДАТКОВІ ФУНКЦІЇ.....	410	12.3 Дані щодо технічного обслуговування.....	418
9.1 Як зберегти: Улюблене.....	410	13. ЕНЕРГОЕФЕКТИВНІСТЬ.....	418
9.2 Блокування функції.....	411	13.1 Енергозбереження.....	418
9.3 Охолоджувальний вентилятор..	411	14. СТРУКТУРА МЕНЮ.....	418
10. ПОРАДИ І РЕКОМЕНДАЦІЇ.....	411	14.1 Меню.....	418
10.1 Рекомендації щодо приготування.....	411	14.2 Підменю для: Опції.....	419
10.2 Рекомендації щодо режиму мікрохвиль.....	411	14.3 Підменю для: Установка.....	419
10.3 Посуд і матеріали, що підходять для використання в мікрохвильових печах.....	412	14.4 Підменю для: Сервіс.....	420
10.4 Рекомендовані налаштування потужності для різних видів страв..	414	15. ЦЕ ЛЕГКО!.....	420
		16. ОХОРОНА ДОВКІЛЛЯ.....	422

1. ⚠ ІНФОРМАЦІЯ З ТЕХНІКИ БЕЗПЕКИ

Перед установкою та експлуатацією приладу слід уважно прочитати інструкцію користувача. Виробник не несе відповідальності за травми або збитки через неправильне встановлення або використання. Інструкції з експлуатації слід зберігати в безпечному і доступному місці з метою користування в майбутньому.

1.1 Безпека дітей і вразливих осіб

- Діти від 8 років та особи з обмеженими фізичними, сенсорними або психічними можливостями чи недостатнім досвідом і знаннями можуть користуватися цим приладом лише під наглядом, або за умови попереднього отримання інструкцій з безпечного користування приладом та розуміння пов'язаних з цим ризиків. Діти до 8 років та особи з важкою та

комплексною непрацездатністю можуть перебувати поблизу приладу лише за умови, якщо знаходяться під безперервним спостереженням.

- Слідкуйте за тим, аби діти не бавилися з приладом .
- Тримайте усі пакувальні матеріали подалі від дітей та утилізуйте їх належним чином.
- **ПОПЕРЕДЖЕННЯ:** Не дозволяйте дітям та домашнім тваринам знаходитися поблизу приладу під час його роботи або охолодження. При роботі відкриті елементи сильно нагріваються.
- Якщо прилад оснащено засобами захисту від доступу дітей, їх необхідно активувати.
- Чищення або обслуговування приладу дітьми дозволяється лише під наглядом.

1.2 Загальна безпека

- Цей прилад призначено виключно для приготування їжі.
- Цей прилад призначений для використання в домашніх умовах у приміщенні.
- Цей прилад можна використовувати в офісах, готельних номерах, напів-готелях, приміщеннях для фермерського туризму та інших подібних приміщеннях, де застосування цього приладу не перевищує (середній) рівень побутового користування.
- Установлювати цей прилад і замінювати кабель повинен лише кваліфікований фахівець.
- Не користуйтеся приладом, доки його не буде встановлено у вбудовану конструкцію.
- Перш, ніж виконувати операції з технічного обслуговування, від'єднайте прилад від джерела живлення.
- У разі пошкодження електричного кабелю його має замінити виробник, його авторизований сервісний центр або інші аналогічно кваліфіковані особи задля уникнення ураження електричним струмом.

- **ПОПЕРЕДЖЕННЯ:** Щоб уникнути ураження електричним струмом, перш ніж починати міняти лампу, переконайтеся, що прилад вимкнено.
- **ПОПЕРЕДЖЕННЯ:** Прилад і його відкриті поверхні нагріваються під час використання. Необхідно поводитись обережно, щоб не торкатися нагрівальних елементів.
- Завжди користуйтеся кухонними рукавицями, коли витягаєте та вставляєте аксесуари чи посуд.
- Використовуйте лише поворотний столик і опору поворотного столика, призначені лише для цього приладу.
- Не вмикайте функцію мікрохвильової печі, коли прилад порожній. Металеві деталі всередині камери можуть спричинити утворення електричної дуги.
- Металеві контейнери для їжі та напоїв заборонено використовувати під час готування в мікрохвильовій печі. Ця вимога не діє в тому разі, якщо виробник зазначив розмір і форму металевих контейнерів, які можна використовувати під час готування в мікрохвильовій печі.
- **ПОПЕРЕДЖЕННЯ!** У разі пошкодження дверцят або ущільнювача дверцят приладом не можна користуватися, доки його не полагодить кваліфікований спеціаліст.
- **ПОПЕРЕДЖЕННЯ!** Лише кваліфікований спеціаліст може виконувати будь-яке обслуговування або ремонтні операції, що передбачають зняття кришки, яка захищає від впливу мікрохвильової енергії.
- **ПОПЕРЕДЖЕННЯ!** Не нагрівайте рідини та інші продукти у герметичних контейнерах. Вони можуть вибухнути.
- Користуйтеся лише тим посудом, який підходить для мікрохвильових печей.

- Під час нагрівання продуктів у пластиковому чи паперовому контейнері наглядуйте за приладом у зв'язку з можливістю загоряння.
- Прилад призначений для нагрівання їжі та напоїв. Сушіння продуктів чи одягу, а також нагрівання грілок, капців, спонжів, вологих ганчірок тощо може призвести до травм, загорання або пожежі.
- У разі виявлення диму вимкніть прилад і витягніть вилку з розетки, щоб погасити полум'я.
- Нагрівання напоїв у мікрохвильовій печі може привести до вибухового закипання із запізненням. Будьте обережні під час поводження з контейнером.
- Уміст пляшечок та баночок із дитячим харчуванням необхідно збовтати або перемішати, а також перевірити його температуру, перш ніж давати дитині, аби уникнути опіків.
- Яйця у шкаралупі та цілі круто зварені яйця не можна нагрівати у приладі, оскільки вони можуть вибухнути навіть після завершення мікрохвильового нагрівання.
- Прилад слід регулярно очищувати та видалити залишки їжі.
- Не використовуйте пароочищувач для очищення приладу.
- Не використовуйте для очищення скляної поверхні дверцят жорсткі абразивні засоби чи металеві шкребки, оскільки це може призвести до появи тріщин на склі, що може спричинити руйнування скла.
- Недотримання чистоти приладу може призвести до погіршення властивостей поверхні, що негативно позначиться на терміні служби приладу та може спричинити небезпечні ситуації.

2. ІНСТРУКЦІЇ З ТЕХНІКИ БЕЗПЕКИ

2.1 Встановлення



ПОПЕРЕДЖЕННЯ!

Установлювати цей прилад повинен лише кваліфікований фахівець.

- Повністю зніміть упаковку.
- Не встановлюйте й не використовуйте пошкоджений прилад.
- Дотримуйтеся інструкцій зі встановлення, що постачаються разом із приладом.
- Будьте обережні під час переміщення приладу, оскільки він важкий. Використовуйте захисні рукавички та взуття, що постачається в комплекті.
- Не тягніть прилад за ручку.
- Встановлюйте прилад у безпечному підходящому місці, що відповідає вимогам зі встановлення.
- Дотримуйтеся вимог щодо мінімальної відстані до інших приладів чи предметів.
- Перед встановленням приладу переконайтеся, що дверцята духової шафи відкриваються без перешкод.
- Прилад оснащено електричною системою охолодження. Він повинен працювати від джерела живлення.
- Вбудований прилад повинен відповідати вимогам щодо стабільності DIN 68930.

Мінімальна висота шафи (Мінімальна висота шафи під робочою поверхнею)	444 (460) мм
Ширина шафи	560 мм
Глибина шафи	550 (550) мм
Висота передньої частини приладу	455 мм
Висота задньої частини приладу	440 мм
Ширина передньої частини приладу	595 мм
Ширина задньої частини приладу	559 мм
Глибина приладу	567 мм
Вбудована глибина приладу	546 мм
Глибина з відкритими дверцятами	882 мм
Мінімальний розмір вентиляційного отвору. Отвір розташований внизу задньої сторони	560x20 мм

Довжина кабелю живлення. Кабель розміщується в правому куті задньої сторони	1500 мм
Кріпильні гвинти	3.5x25 мм

2.2 Підключення до електромережі



ПОПЕРЕДЖЕННЯ!

Існує ризик займання та ураження електричним струмом.

- Усі роботи з під'єднання до електромережі мають виконуватися кваліфікованим електриком.
- Прилад повинен бути заземленим.
- Переконайтеся в тому, що параметри на табличці з технічними даними сумісні з електричними параметрами електроживлення від мережі.
- Завжди використовуйте правильно встановлену протиударну розетку.
- Не використовуйте розгалужувачі, перехідники й подовжувачі.
- Будьте обережні, аби не пошкодити штепсельну вилку та кабель. Якщо кабель живлення потребує заміни, зверніться до нашого сервісного центру.
- Пильнуйте, щоб кабель живлення не торкався або не був надто наближений до дверцят приладу або ніші під приладом, особливо коли він працює або дверцята гарячі.
- Елементи захисту від ураження електричним струмом та ізоляція мають бути закріплені так, аби їх не можна було зняти без спеціального інструмента.
- Вставляйте штепсельну вилку в розетку електроживлення лише після закінчення установки. Переконайтеся, що після установки є вільний доступ до розетки електроживлення.
- Не вставляйте вилку в розетку, яка ненадійно закріплена.
- Не тягніть за кабель живлення, щоб відключити прилад з мережі. Завжди вимикайте, витягаючи штепсельну вилку.
- Використовуйте лише належні ізолюючі пристрої, а саме: лінійні роз'єднувачі, запобіжники (гвинтові запобіжники слід викрутити з патрона), реле захисту від замикання на землю та контактори.
- Електрообладнання має бути оснащеним ізолюючим пристроєм для повного відключення від електромережі. Зазор між контактами ізолюючого пристрою має становити не менше 3 мм.
- Цей прилад оснащено електричним кабелем із вилкою.

2.3 Користування



ПОПЕРЕДЖЕННЯ!

Існує небезпека травмування, опіків, ураження електричним струмом і вибуху.

- Не змінюйте технічні специфікації цього приладу.
- Переконайтеся в тому, що вентиляційні отвори не заблоковано.
- Під час роботи приладу не залишайте його без нагляду.
- Вимикайте прилад після кожного використання.
- Будьте обережні, відчиняючи дверцята приладу під час його роботи. Можливе вивільнення гарячого повітря.

- Не працюйте з приладом, якщо ваші руки мокрі або якщо він контактує з водою.
- Не натискайте на відчинені дверцята.
- Не використовуйте прилад як робочу поверхню або як поверхню для зберігання речей.
- Обережно відчиняйте дверцята приладу. Використання інгредієнтів зі спиртом може призвести до утворення суміші спирту й повітря.
- Відчиняючи дверцята, пильнуйте, щоби поряд із пристроєм не було джерел утворення іскор та відкритого вогню.
- Не кладіть усередину приладу, поряд із ним або на нього легкозаймисті речовини чи предмети, змочені в легкозаймистих речовинах.
- Не використовуйте функцію мікрохвильової печі для попереднього прогрівання духової шафи.



ПОПЕРЕДЖЕННЯ!

Існує ризик пошкодження приладу.

- Щоб запобігти пошкодженню або знебарвленню емалі, дотримуйтеся таких рекомендацій:
 - не кладіть алюмінієву фольгу безпосередньо на дно камери приладу;
 - не ставте посуд із водою безпосередньо в розігрітій прилад;
 - не залишайте в приладі страви і продукти з високим вмістом вологи після завершення приготування їжі;
 - будьте обережні, виймаючи або встановлюючи аксесуари.
- Знебарвлення емалі або нержавіючої сталі не впливає на ефективність роботи приладу.
- Завжди готуйте із зачиненими дверцятами приладу.
- Якщо прилад розміщено позаду меблевої панелі (наприклад, дверцят), переконайтеся, що дверцята відкрито під час роботи приладу. Жар і волога можуть утворюватися позаду закритої меблевої панелі, спричиняючи подальше пошкодження приладу, корпусу або підлоги. Не закривайте меблеву панель, доки прилад повністю не охолоне після використання.

2.4 Догляд і чищення



ПОПЕРЕДЖЕННЯ!

Існує ризик отримання травм, пожежі або пошкодження приладу.

- Перед початком ремонту прилад треба від'єднати від електромережі, знявши запобіжник або витягнувши шнур живлення з розетки.
- Дайте приладу охолонути. Існує ризик того, що скляні панелі можуть тріснути.
- У разі пошкодження скляних панелей дверцят слід одразу замінити панелі. Зверніться до авторизованого сервісного центру.
- Будьте обережні, знімаючи дверцята з приладу. Дверцята важкі!
- Обов'язково витріть камеру, поворотний столик й дверцята насухо після кожного використання. Пара, утворювана під час роботи приладу, конденсується на стінках камери, що може призвести до корозії.
- Регулярно очищуйте прилад, щоб запобігти пошкодженню матеріалу поверхні.
- Залишки їжі та жир, що знаходяться у приладі, можуть призвести до виникнення пожежі й електричної дуги під час увімкненої функції мікрохвильової печі.
- Протріть прилад вологою м'якою ганчіркою. Застосовуйте лише нейтральні миючі засоби. Не використовуйте абразивні засоби, жорсткі серветки для очищення, розчинники або металеві предмети.

ІНСТРУКЦІЇ З ТЕХНІКИ БЕЗПЕКИ

- Якщо ви користуєтеся аерозолями для чищення духових шаф, обов'язково дотримуйтеся інструкцій із безпеки, наведених на упаковці.

2.5 Внутрішня підсвітка



ПОПЕРЕДЖЕННЯ!

Небезпека враження електричним струмом.

- Стосовно ламп всередині цього виробу та запасних ламп, що продаються окремо: Ці лампи призначені для використання у побутових приладах з екстремальними фізичними умовами, такими як температура, вібрація, вологість, або призначені для надання інформації про стан роботи приладу. Вони не призначені для використання з іншою метою та не придатні для освітлення побутових приміщень.
- У цьому виробі є джерело світла класу енергоефективності G.
- Використовуйте лише лампочки з такими ж технічними характеристиками .

2.6 Сервіс

- Для ремонту приладу звертайтеся до авторизованого сервісного центру.
- Використовуйте лише оригінальні запасні частини.

2.7 Утилізація



ПОПЕРЕДЖЕННЯ!

Існує небезпека задушення.

- По інформацію з належної утилізації приладу зверніться до органів муніципальної влади.
- Від'єднайте прилад від електромережі.
- Відріжте кабель електричного живлення близько до приладу та утилізуйте його.
- Приберіть фіксатор дверцят, щоб унеможливити їх зачинення, якщо діти, або домашні тварини опиняться всередині приладу.

Цей продукт по вмісту небезпечних речовин відповідає вимогам Технічного регламенту обмеження використання деяких небезпечних речовин в електричному та електронному обладнанні (постанова Кабінету Міністрів України №139 від 10 березня 2017р.)

3. ОПИС ВИРОБУ

3.1 Загальний огляд

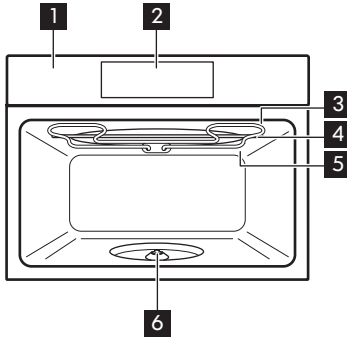

- 1** Панель керування
- 2** Дисплей
- 3** Нагрівальний елемент
- 4** Мікрохвильовий генератор
- 5** Лампа

- 6** Вал поворотного столика

3.2 Аксесуари

Конструкція Turntable
Для приготування їжі.

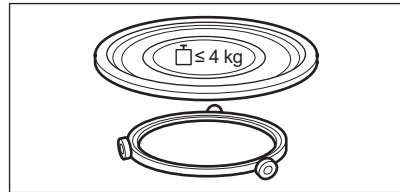

Конструкція решітки для гриля
Для приготування на грилі.

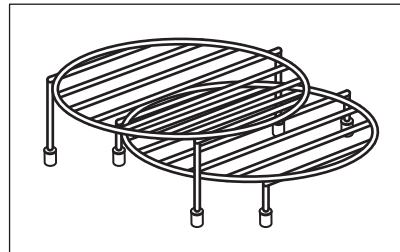

4. УВІМКНЕННЯ ТА ВИМКНЕННЯ ДУХОВОЇ ШАФИ

4.1 Панель керування

УВІМКНЕННЯ ТА ВИМКНЕННЯ ДУХОВОЇ ШАФИ

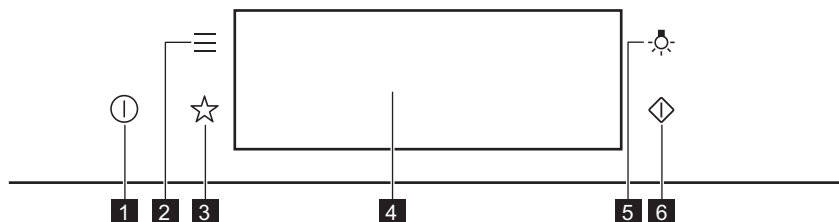



1	Увімк. / Вимк.	Натисніть і утримуйте для увімкнення та вимкнення духової шафи.
2	Меню	Перелік функцій духової шафи.
3	Улюблене	Перелік улюблених налаштувань.
4	Дисплей	Показує поточні налаштування духової шафи.
5	Перемикач лампи	Увімкнення і вимкнення лампи.
6	Швидкий старт мікрохвильової печі	Увімкнення функції мікрохвильової печі (1000 Вт і 30 секунд).

Натисніть	Перемістіть	Натисніть і утримуйте
Торкніться поверхні пальцем.	Переміщуйте палець по поверхню.	Торкніться поверхні протягом 3 секунд.

4.2 Дисплей





	<p>Після увімкнення на дисплеї відобразиться головний екран із функцією та інтенсивністю гриля за промовчанням.</p> <ul style="list-style-type: none"> A. Час доби B. ПОЧАТОК/ЗУПИНКА C. Інтенсивність гриля D. Функції нагріву E. Потужність мікрохвиль F. Таймер
--	--

ПЕРЕД ПЕРШИМ ВИКОРИСТАННЯМ



 12:34	Якщо духова шафа не використовується протягом 2 хвилин, дисплей переходить у режим очікування.
 1000W	Під час готування на дисплеї відображаються встановлені функції та інші доступні опції.
 1m23s	12:34 +30s STOP

Індикатори дисплея



Базові індикатори — для навігації на дисплеї.

 Підтвердження вибору/налаштування.	 Перехід на один рівень назад у меню.	 Скасування останньої дії.	 Вимкнення та ввімкнення опцій.
---	---	--	---

Звуковий сигнал індикатори функції — після закінчення встановленого часу готування лунає сигнал.

 Функцію ввімкнено.	 Функцію ввімкнено. Готування припиняється автоматично.	 Звуковий сигнал вимкнено.
--	--	---

Індикатори таймера

 Щоб установити функцію: Відкладений запуск.	 Скасування налаштування.
--	---

5. ПЕРЕД ПЕРШИМ ВИКОРИСТАННЯМ





ПОПЕРЕДЖЕННЯ!

Див. розділи з інформацією щодо техніки безпеки.

ЩОДЕННЕ КОРИСТУВАННЯ

5.1 Первинне очищення

		
Крок 1	Крок 2	Крок 3
Вийміть з духової шафи все приладдя.	Очистьте духову шафу й аксесуари за допомогою м'якої ганчірки, змоченої в теплій воді з додаванням м'якого засобу для чищення.	Вставте аксесуари в духову шафу.

5.2 Перше підключення

Після першого підключення на дисплеї відображається повідомлення з привітанням. Потрібно встановити: Мова, Яскравість дисплею, Сигнали кнопок управл., Рівень гучності, Час доби.

6. ЩОДЕННЕ КОРИСТУВАННЯ



ПОПЕРЕДЖЕННЯ!

Див. розділи з інформацією щодо техніки безпеки.

6.1 Налаштування функції: Гриль + МХ, Гриль

Духова шафа може створювати певні шуми в разі використання функції: Гриль + МХ. Це нормально для цієї функції.

Налаштування функції: Гриль + МХ	
Крок 1	Установіть низьку стійку для гриля.
Крок 2	Увімкніть духову шафу. На дисплеї відображається функція нагріву за промовчанням.
Крок 3	Натисніть символ функції нагріву для входу в підменю.
Крок 4	Оберіть функцію:  . Натисніть: ОК.
Крок 5	Оберіть рівень інтенсивності гриля.
Функція	Рівень інтенсивності гриля
Lo	низький

Налаштування функції: Гриль + МХ	
Ні	високий
Крок 6	Натисніть: ОК.
Крок 7	Натисніть: START .
STOP — натисніть, щоби вимкнути духову шафу.	
Крок 8	Вимкніть духову шафу.

Потужність мікрохвильового нагрівання обмежена до 500 Вт у разі використання функції: Гриль + МХ.

Налаштування функції: Гриль	
Крок 1	Встановіть високу стійку для гриля.
Крок 2	Увімкніть духову шафу. На дисплеї відображається функція нагріву за промовчанням.
Крок 3	Натисніть символ функції нагріву для входу в підменю.
Крок 4	Оберіть функцію:  . Натисніть: ОК.
Крок 5	Оберіть рівень інтенсивності гриля.
Функція	Рівень інтенсивності гриля
Lo	низький
Ні	високий
Крок 6	Натисніть: ОК.
Крок 7	Натисніть: START .
STOP – натисніть для вимкнення функції.	
Крок 8	Вимкніть духову шафу.

6.2 Налаштування: Мікрохвильові функції нагріву

Крок 1	Увімкніть духову шафу.
Крок 2	Натисніть символ функції нагріву для входу в підменю.
Крок 3	Виберіть функцію нагрівання НВЧ-хвилями та натисніть: OK . На дисплей виводиться: потужність НВЧ-хвиль.
Крок 4	Встановіть: потужність НВЧ-хвиль. Натисніть: OK .
Крок 5	Натисніть: START .
STOP – натисніть для вимкнення функції.	
Крок 6	Вимкніть духову шафу.

Максимальний час роботи мікрохвильових функцій залежить від установленної потужності мікрохвиль:

ПОТУЖНІСТЬ МІКРОХВИЛЬ	МАКСИМАЛЬНИЙ ЧАС
100–600 Вт	59 хвилин
Понад 600 Вт	7 хвилин



Якщо відчинити дверцята, процедура зупиниться. Щоб запустити її знову, натисніть **START**.

Оберіть найлегший спосіб!





6.3 Спосіб використання: Швидкий старт мікрохвильової печі

Крок 1	Натисніть і утримуйте:  . Функція мікрохвиль працює 30 секунд.
---------------	---



Крок 2	Щоб продовжити час готування:	
	Натисніть на значення часу роботи, щоб перейти до налаштувань часу. Встановіть час приготування.	Натисніть +30 s.
Функцію мікрохвиль можна увімкнути у будь-який час з: Швидкий старт мікрохвильової печі.		

6.4 Функції нагрівання



СТАНДАРТНА

Функція нагріву	Додаток
 Гриль	Для готування на грилі тонких смужок продуктів, а також для смаження хліба.
 Гриль + МХ	Приготування їжі за короткий проміжок часу та отримання рум'яної скоринки. Можна встановити 2 рівні інтенсивності гриля: низький і високий.
 Мікрохвилі	Розігрівання, приготування, діапазон потужності: 100–1000 Вт

МІКРОХВИЛІ

Функція нагріву	Додаток
 Розморожування	Розморожування м'яса, риби, тортів, діапазон потужності: 100–200 Вт
 Плавлення	Розтоплювання шоколаду та масла, діапазон потужності: 100–400 Вт
 Розігріти	Розігрівання попередньо приготовлених страв і легких страв, діапазон потужності: 300–700 Вт

ФУНКЦІЇ ГОДИННИКА

Функція нагріву	Додаток
 Попкорн	Приготування попкорну, діапазон потужності: 700–1000 Вт
 Розігрівання рідин	Розігрівання напоїв і супів, діапазон потужності: 800–1000 Вт

7. ФУНКЦІЇ ГОДИННИКА

7.1 Опис функцій годинника

Функція годинника	Додаток
Тривалість приготування	Установлення тривалості готування. Максимум 23 год 59 хв.
Закінчення дії	Визначення дій після завершення відліку часу таймером.
Додатковий час	Подовження часу готування.
Нагадування	Налаштування часу зворотного відліку. Максимум становить 23 год 59 хв. Ця функція не впливає на роботу духової шафи.
Таймер прямого відліку	Відстежує тривалість роботи функції. Таймер прямого відліку - можна увімкнути і вимкнути.

7.2 Налаштування: Функції годинника



Налаштування годинника	
Крок 1	Натисніть: Час доби.
Крок 2	Встановіть час. Натисніть: ОК.

Встановлення часу готування	
Крок 1	Оберіть функцію нагріву.

Встановлення часу готування

Крок 2	Натисніть:  .
Крок 3	Встановіть час. Натисніть: OK .

Як обрати опцію закінчення

Крок 1	Оберіть функцію нагріву.
Крок 2	Натисніть:  .
Крок 3	Встановіть час приготування.
Крок 4	Натисніть:  .
Крок 5	Натисніть: Закінчення дії.
Крок 6	Оберіть бажані дії: Закінчення дії.
Крок 7	Натисніть: OK . Повторіть цю дію, доки на дисплеї не відобразиться головне меню.

Як подовжити час готування

Коли залишається 10 % часу готування, а страва здається не достатньо готовою, можна подовжити час готування. Також можна змінити функцію нагріву.

Щоби подовжити час готування, натисніть **+1 хв**.

Зміна налаштувань таймера

Крок 1	Натисніть:  .
Крок 2	Встановіть значення таймера.
Крок 3	Натисніть: OK .

Встановлений час можна змінити в будь-який момент процесу готування.

8. СПОСІБ ВИКОРИСТАННЯ: АКСЕСУАРИ

8.1 Встановлення аксесуарів

Використовуйте лише відповідний посуд і матеріали. Див. розділ «Посуд і матеріали, що підходять для мікрохвиль» глави «Поради та рекомендації».

Конструкція Turntable:

Завжди готуйте їжу на поворотному столику.

Помістіть направляючий ролик навколо вала приводу. Розмістіть поворотне скло на направляючому ролику. Використовуйте лише той поворотний столик, що постачається в комплекті з приладом.

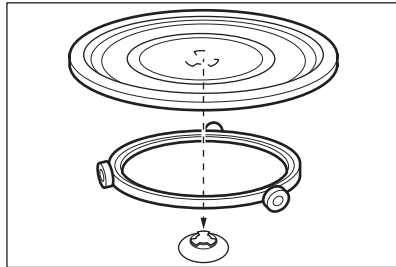

Конструкція решітки для гриля:

Поставте підставку гриля на поворотний столик таким чином, аби силіконові насадки були спрямовані донизу.

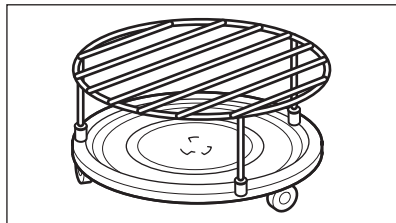

9. ДОДАТКОВІ ФУНКЦІЇ

9.1 Як зберегти: Улюблене

Ви можете зберігати свої улюблені налаштування, як-от функція нагріву, час приготування або функція очищення. Можна зберегти три улюблені налаштування.



Крок 1	Увімкніть духову шафу.
Крок 2	Оберіть бажане налаштування.
Крок 3	Натисніть:  . Оберіть: Улюблене.
Крок 4	Виберіть: Зберегти поточні налаштування.
Крок 5	Натисніть +, щоби додати налаштування до переліку: Улюблене. Натисніть OK.

 — натисніть, щоби скинути налаштування.

 — натисніть, щоби скасувати налаштування.

9.2 Блокування функції

Ця функція запобігає випадковій зміні функції нагріву.

Крок 1	Увімкніть духову шафу.
Крок 2	Установіть функцію підігріву.
Крок 3	  — натисніть одночасно, щоб увімкнути функцію.
Щоби вимкнути функцію, повторно виконайте крок 3.	

9.3 Охолоджувальний вентилятор

Під час роботи духової шафи охолоджувальний вентилятор автоматично вмикається для підтримки поверхонь духової шафи прохолодними. Якщо вимкнути духову шафу, вентилятор продовжуватиме працювати, доки духову шафу не охолоне.

10. ПОРАДИ І РЕКОМЕНДАЦІЇ

10.1 Рекомендації щодо приготування

<p>У таблицях указано орієнтовні значення температури та часу приготування. Вони залежать від рецепту, а також якості та кількості інгредієнтів, що використовуються.</p> <p>У вашій духовій шафі приготування страв може відрізнятись від приготування у вашій попередній моделі духовки. Наведені нижче вказівки містять рекомендовані налаштування температури, часу готування та положення полиці для певних типів продуктів.</p> <p>Якщо ви не можете знайти налаштування для певного рецепту, скористайтеся налаштуваннями для аналогічного рецепту.</p> <p>Додаткові рекомендації щодо приготування їжі наведені в таблицях готування на нашому веб-сайті. Щоб знайти поради щодо готування, звертєся з номером PNC на табличці з технічними даними, розміщеній на передній рамі камери духової шафи.</p>

10.2 Рекомендації щодо режиму мікрохвиль

Давайте готувати!

Не кладіть продукти безпосередньо на поворотний столик. Завжди користуйтеся посудом, придатним для використання у мікрохвильовій печі.

Поставте посуд у центр поворотного столика.

Через контакт із занадто гарячими або занадто холодними предметами поворотний столик може поламатися.

Переверніть або перемішайте страву після завершення половини часу розморожування й готування.

Помішуйте рідини час від часу.

Помішайте страву перед подачею.

Накривайте страву під час приготування й розігрівання.

ПОРАДИ І РЕКОМЕНДАЦІЇ

Поставте ложку у пляшку або склянку при підігріванні напоїв для забезпечення кращого розподілу тепла.

Кладіть продукти у піч без упаковки. Фасовані готові страви можна ставити у піч лише якщо їхня упаковка підходить для використання у мікрохвильовій печі (перевірте інформацію на упаковці).



Готування з використанням мікрохвиль

Готуйте страви під кришкою. Якщо ви хочете зберегти скоринку, готуйте страву без кришки.

Не перегрівайте страви, встановивши занадто високу потужність і час. Їжа може місцями пересохнути, підгоріти або загорітися.

Не використовуйте піч для приготування яєць у шкаралупі, оскільки існує загроза їх розривання. Проколіть жовток яєчні перед її підігріванням.

Перш ніж готувати продукти зі шкіркою, слід кілька разів проколоти її.

Овочі слід нарізати на однакові за розміром шматки.

Після вимкнення духовки вийміть страву та дайте їй постояти декілька хвилин, щоб тепло розподілилося рівномірно.



Розморожування з використанням мікрохвиль

Покладіть заморожену страву без упаковки на маленьку перевернуту тарілку, розміщену над контейнером, або на підставку для розмороження чи пластикове сито, щоб рідина, що утворюється при розморожуванні, могла стікати.

Потім вийміть розморожені шматочки.

Для приготування овочів і фруктів без попереднього розморожування можна використовувати більш високу потужність мікрохвиль.

10.3 Посуд і матеріали, що підходять для використання в мікрохвильових печах

У мікрохвильових печах використовуйте лише відповідний посуд і матеріали. Для довідки див. таблицю нижче.

Перед використанням ознайомтеся з характеристиками посуду / матеріалу.

















Посуд / матеріал				
Жаростійке скло та фарфор без металевих елементів, як-от вогнетривке скло	✓	✓	✓	✓
Звичайне скло й порцеляна без вмісту срібла, золота, платини чи інших металевих оздоблень	✓	✗	✗	✗

Посуд / матеріал				
Скло та склокераміка з жаро- або морозостійких матеріалів	✓	✓	✓	✓
Керамічний та фаянсовий посуд без вмісту кварцових чи металевих елементів та без металевого глазурування	✓	✓	✗	✗
Кераміка, порцеляна та фаянс із неглазурованим дном чи маленькими отворами, як-от на ручках	✗	✗	✗	✗
Жаростійкий пластик, що витримує температуру до 200 °C	✓	✓	✗	✗
Картон, папір	✓	✗	✗	✗
Харчова плівка	✓	✗	✗	✗
Плівка для запікання, придатна для використання в мікрохвильових печах	✓	✓	✗	✗
Жаровні з металу, як-от емаль, чавун	✗	✗	✓	✗
Форми для випікання, покриті чорним лаком або силіконовим покриттям	✗	✗	✓	✗
Посуд для використання в мікрохвильовій печі, як-от деко для запікання з хрусткою скоринкою	✗	✓	✗	✗
Конструкція решітки для гриля	✗	✗	✓	✓

ПОРАДИ І РЕКОМЕНДАЦІЇ

10.4 Рекомендовані налаштування потужності для різних видів страв





Дані в таблиці є орієнтовними.

800–1000 Вт					
 Обсмажування на початку процесу готування			 Підігрів рідин		
500–700 Вт					
 Готування овочів	 Приготування яєць	 Повільне приготування печені	 Повільне готування рису	 Нагрівання страви для однієї тарілки	 Розморожування та підігрів заморожених страв
300–400 Вт					
 Плавлення сиру, шоколаду, масла	 Готування / підігрів легких страв		 Продовження готування		
100–200 Вт					
 Підігрів дитячого харчування	 Розморожування хліба	 Розморожування фруктів і тортів	 Розморожування сиру, вершків, масла	 Розморожування м'яса, риби	

10.5 Таблиці приготування їжі для дослідницьких установ

Інформація для дослідницьких установ

Тестування відповідно до стандарту IEC 60705.

МІКРОХВИЛЬОВА ФУНКЦІЯ	 (Вт)	 (кг)		 (хв)	
Бісквіт	600	0.475	Конструкція поворотного столика	5 - 7	-
М'ясний хлібець	500	0.9	Конструкція поворотного столика	18 - 20	-
Заварний крем	500	1	Конструкція поворотного столика	15 - 17	-
Розморожування м'яса	200	0.5	Конструкція поворотного столика	8 - 9	-

**Використовуйте функцію: Гриль у мікрохвильовій печі.
Використовуйте низьку стійку для гриля.**

КОМБІНОВАНА МІКРОХВИЛЬОВА ФУНКЦІЯ	 (Вт)	 Рівень інтенсивності гриля	 (хв)	
Картопляна запіканка (гратен), 1,1 кг	300	низький	30 - 35	-
Курка, 1,1 кг	300	високий	30 - 35	Покладіть м'ясо в круглий скляний контейнер.

11. ДОГЛЯД ТА ЧИСТКА





ПОПЕРЕДЖЕННЯ!

Див. розділи з інформацією щодо техніки безпеки.

УСУНЕННЯ ПРОБЛЕМ

11.1 Примітки щодо чищення

 Засоби для чищення	Очищіть лицьову панель духової шафи за допомогою м'якої ганчірки, змоченої в теплій воді з додаванням м'якого засобу для чищення.
	Металеві поверхні слід чистити за допомогою розчину для чищення.
	Використовуйте неагресивний засіб для чищення плям.
 Щоденне користування	Очищуйте камеру духової шафи після кожного використання. Накопичення жиру й інших залишків їжі може спричинити загоряння. Ретельно очищуйте стелю камери духової шафи від залишків їжі й жиру.
	Не залишайте готові страви у духовій шафі довше 20 хвилин. Протирайте внутрішню камеру м'якою тканиною після кожного використання.
 Акcesуари	Після кожного використання мийте та просушуйте всі акcesуари. Перед очищення поворотного столика зачекайте, доки він прохолоне. Є ризик, що поворотний столик може тріснути. Використовуйте м'яку ганчірку, змочену в теплій воді з додаванням неагресивного засобу для очищення. Не мийте акcesуари у посудомийній машині.
	Акcesуари з антипригарним покриттям забороняється мити з використанням агресивних засобів чи гострих предметів.



12. УСУНЕННЯ ПРОБЛЕМ









ПОПЕРЕДЖЕННЯ!

Див. розділи з інформацією щодо техніки безпеки.

12.1 Дії в разі виникнення проблем

 Духова шафа не вмикається або не розігрівається	
 Можлива причина	 Спосіб вирішення
Духову шафу не під'єднано до електромережі або під'єднано неправильно.	Переконайтеся, що духову шафу було правильно під'єднано до електромережі.



 Духова шафа не вмикається або не розігрівається	
 Можлива причина	 Спосіб вирішення
Годинник не встановлено.	Встановіть годинник, див. детальну інформацію в розділі «Функції годинника», Встановлення: Функції годинника.
Дверцята зачинено неправильно.	Повністю зачиніть дверцята.
Запобіжник перегорів.	Переконайтеся, що запобіжник є причиною проблеми. Якщо проблема виникає знову, зверніться до кваліфікованого електрика.
Увімкнено захист від доступу дітей духової шафи.	Див. розділ «Меню», підменю для: Опції.



 Компоненти	
 Опис	 Спосіб вирішення
Лампочка перегоріла.	Замініть лампу, детальну інформацію див. в розділі «Догляд та очищення», Як замінити: Лампа.
Поворотний столик видає шум.	Під поворотним столиком є залишки їжі.

12.2 Як керувати: Коди помилок

У випадку помилки програмного забезпечення на дисплеї відображається повідомлення про помилку.

У цьому розділі представлено перелік проблем, які ви можете вирішити самостійно.

 Код і опис	 Вирішення
F240, F439 - сенсорні поля на дисплеї не працюють належним чином.	Очистіть передню поверхню дисплею. Переконайтеся, що на сенсорних полях немає бруду.

 Код і опис	 Вирішення
F908 - система духової шафи не може підключитися до панелі управління.	Вимкніть та увімкніть духовку.

12.3 Дані щодо технічного обслуговування

Якщо Ви не можете вирішити проблему самостійно, зверніться до закладу, де Ви придбали прилад, або до авторизованого сервісного центру. Дані, потрібні для сервісного центру, вказані на табличці з технічними даними. Паспортна табличка розташована на передньому краї духової шафи. Не знімайте паспортну табличку з духової шафи.

Рекомендуємо записати дані тут:	
Модель
Код виробу
Серійний номер

13. ЕНЕРГОЕФЕКТИВНІСТЬ

13.1 Енергозбереження

 Духова шафа має функції, що допомагають зберігати електроенергію під час щоденного готування.
--

Переконайтеся у тому, що під час роботи дверцята духової шафи зачинено. Не відкривайте дверцята духової шафи занадто часто під час готування. Підтримуйте чистоту ущільнювача дверцят і переконайтеся, що його належним чином зафіксовано. Коли можливо, не розігривайте духову шафу перед готуванням. Якщо ви послідовно готуєте кілька страв, зведіть перерви між ними до мінімуму.

Готування з вимкненою лампою

Вимкніть лампу під час готування. Вмикайте її лише за потреби.

14. СТРУКТУРА МЕНЮ

14.1 Меню

Натисніть , щоб відкрити Меню.

Пункт меню	Додаток
Улюблене	Перелік улюблених налаштувань.

Пункт меню		Додаток
Опції		Налаштування конфігурації духової шафи.
Налаштування	Установка	Налаштування конфігурації духової шафи.
	Сервіс	Відображення версії та конфігурації програмного забезпечення.

14.2 Підменю для: Опції

Підменю	Додаток
Підсвітка	Увімкнення і вимкнення лампи.
Захист від доступу дітей	Запобігає випадковому увімкненню духової шафи. Після активації цієї опції під час увімкнення духової шафи на дисплеї з'являється напис «Child Lock» (Захист від доступу дітей). Для увімкнення духової шафи оберіть літери коду в алфавітному порядку. Коли захист від доступу дітей активовано, у вас зберігається можливість користуватися таймером, дистанційним керуванням і лампою.
Індикація часу	Увімкнення та вимкнення годинника.
Цифровий стиль годинника	Зміна формату індикації часу, що відображається.

14.3 Підменю для: Установка

Підменю	Опис
Мова	Встановлення мови духової шафи.
Яскравість дисплею	Встановлення яскравості дисплея.
Сигнали кнопок управл.	Увімкнення і вимкнення звуку натискання сенсорних кнопок. Неможливо вимкнути звук для: ①.

ЦЕ ЛЕГКО!

Підменю	Опис
Рівень гучності	Встановлення гучності звуку натискання кнопок та сигналів.
Час доби	Встановлення поточного часу й дати.

14.4 Підменю для: Сервіс



Підменю	Опис
Демонстраційний режим	Код активації/деактивації: 2468
Версія програмного забезпечення	Інформація про версію програмного забезпечення.
Скинути всі налаштування	Відновлює заводські налаштування.

15. ЦЕ ЛЕГКО!

Перед першим використанням потрібно встановити такі параметри:

Мова	Яскравість дисплею	Сигнали кнопок управл.	Рівень гучності	Час доби
------	--------------------	------------------------	-----------------	----------

Ознайомтеся з основними символами на панелі керування та дисплеї:

 Увімк. / Вимк.	 Меню	 Улюблене	 Таймер	START / STOP
---	---	---	---	--------------

Початок користування духовою шафою



Швидкий запуск функції MW	Увімкнення мікрохвильової функції в будь-який час із налаштуваннями за промовчанням: 30 с / 1000 Вт.	Натисніть:  .
----------------------------------	--	--

			
---	---	---	---

підігрів/готування 100–1000 Вт	готування/ підрум'янювання інтенсивність: низька/висока	готування/ підрум'янювання	підігрів рідин 800–1000 Вт
			
розігрівання 300–700 Вт	розморожування 100–200 Вт	розтоплювання 100–400 Вт	приготування попкорну 700–1000 Вт

Налаштування функції мікрохвиль		Поради щодо використання функції мікрохвиль
Потужність мікрохвиль:	Максимальний час:	<p>Накривайте страву під час приготування й розігрівання.</p> <p>Переверніть або перемішайте страву після завершення половини часу розморожування й готування.</p> <p>Під час підігрівання рідин покладіть у страву ложку.</p> <p>Поставте страву в духову шафу без упаковки (лише призначений для мікрохвильових печей посуд).</p>
100–600 Вт	59 хв	
> 600 Вт	7 хв	



Початок готування

Крок 1	Крок 2	Крок 3	Крок 4	Крок 5
 <p>— натисніть, щоб увімкнути духову шафу.</p>	 <p>... — виберіть функцію.</p>	<p>Вт</p> <p>— встановіть потужність мікрохвильової печі.</p>	<p>OK</p> <p>— натисніть, щоб підтвердити.</p>	<p>START</p> <p>— натисніть, щоб розпочати готування.</p>

Використовуйте функції швидкого доступу для встановлення часу готування

<p>Допомога за 10% до завершення</p> <p>Використовуйте функцію «Допомога за 10% до завершення», щоб додати час, коли залишилося 10% часу готування.</p>	<p>Щоб подовжити час готування, натисніть +1 хв.</p>
--	---

16. ОХОРОНА ДОВКІЛЛЯ

Здавайте на повторну переробку матеріали, позначені відповідним символом . Викидайте упаковку у відповідні контейнери для вторинної сировини. Допоможіть захистити навколишнє середовище та здоров'я інших людей і забезпечити вторинну переробку електричних і електронних приладів. Не викидайте прилади, позначені відповідним символом , разом з іншим домашнім сміттям. Поверніть продукт до заводу із вторинної переробки у вашій місцевості або зверніться до місцевих муніципальних органів влади.

www.aeg.com/shop



867370958-A-152022



AEG