

---

# IR-210

## Universal IR Learning Remote Module

User Manual v1.8



[www.icpdas.com](http://www.icpdas.com)



---

## **Warranty**

All products manufactured by ICP DAS are under warranty regarding defective materials for a period of one year from the date of delivery to the original purchaser.

## **Warning**

ICP DAS assumes no liability for damages resulting from the use of this product. ICP DAS reserves the right to change this manual at any time without notice. The information furnished by ICP DAS is believed to be accurate and reliable. However, no responsibility is assumed by ICP DAS for its use, or for any infringements of patents or other rights of third parties resulting from its use.

## **Copyright**

Copyright 2011-2020 by ICP DAS. All rights are reserved.

## **Trademark**

The names used for identification only may be registered trademarks of their respective companies.

---

## Contents

<b>1. Introduction</b> .....	<b>3</b>
1.1 Features .....	4
1.2 Applications .....	4
<b>2. Hardware</b> .....	<b>5</b>
2.1 Specifications .....	5
2.2 Appearance .....	6
2.3 Pin assignments .....	7
2.4 Wire connection.....	8
2.4.1 RS-232 connection.....	8
2.4.2 RS-485 connection.....	9
2.4.3 IR output.....	11
2.4.4 Power connection.....	11
2.5 Watchdog setting.....	12
2.6 Firmware Update DIP Switch .....	13
2.6.1 Update firmware .....	13
2.6.2 Firmware operation mode .....	14
2.7 LED Indicators.....	16
<b>3. Software</b> .....	<b>18</b>
3.1 The configuration tool– IR Utility.....	18
3.2 IR-210 Utility.....	19
3.2.1 Menu .....	20
3.2.2 Open/Close COM port.....	24
3.2.3 Set Device & IR Command Quantity .....	25
3.2.4 Test and Save Learned Commands .....	27
3.2.5 Test the IR commands in IR-210 .....	29
3.2.6 Copy IR Commands from File .....	30
3.2.7 Display Waveforms of IR Commands.....	32
<b>4. Learning IR command Example</b> .....	<b>33</b>
4.1 IR-210 communication settings .....	33
4.2 Configure the quantity of the IR-controlled devices and IR commands .	34
4.3 Learning and testing IR commands.....	35
4.4 Saving the Learned IR Commands to a File.....	36
4.5 Download the IR Learning Commands to the IR-210 .....	36
4.6 Test the IR commands saved in the IR-210.....	36
4.7 Load the IR Learning Commands from the File.....	37
4.8 Load IR Learning Commands from the IR-210.....	37
<b>5. Modbus Registers Addresses</b> .....	<b>38</b>
<b>6. Technical support</b> .....	<b>40</b>

# 1. Introduction

The Intelligent Home automation is the hot topic recently in the world. Every country is striving for developing various home application systems for better life now. However, in every family, there are many appliances with the low cost IR interface to be remote controlled by a handheld controller. And, there is not a standard of the IR control in these appliances. If we can manage these appliances, the power consumption will be managed more efficiently. Therefore, ICP DAS has developed various IR products to apply in home automation. These IR products will help users to control and integrate these IR appliances into a control system. And, by integrating the PAC and others series of ICP DAS, users can easily to establish the home automation system.

IR-210 is a universal IR learning remote module which can learn IR remote commands of diverse electronic devices. The learning commands can be stored in the module or saved to a file. IR-210 supplies 6 IR output channels for individual or simultaneous control on multiple devices. The accompanied RS-232 and RS-485 interfaces with Modbus/RTU protocol provide more flexible expansion and control on the module. Besides, IR-210 software utility provides users with easy configuration, learning, test and storage of IR commands. As a replacement of IR remote controls and a module that can be easily integrated with Modbus master devices (e.g. PAC, PLC, PC... etc.), IR-210 is well-suited for smart home and building automation.

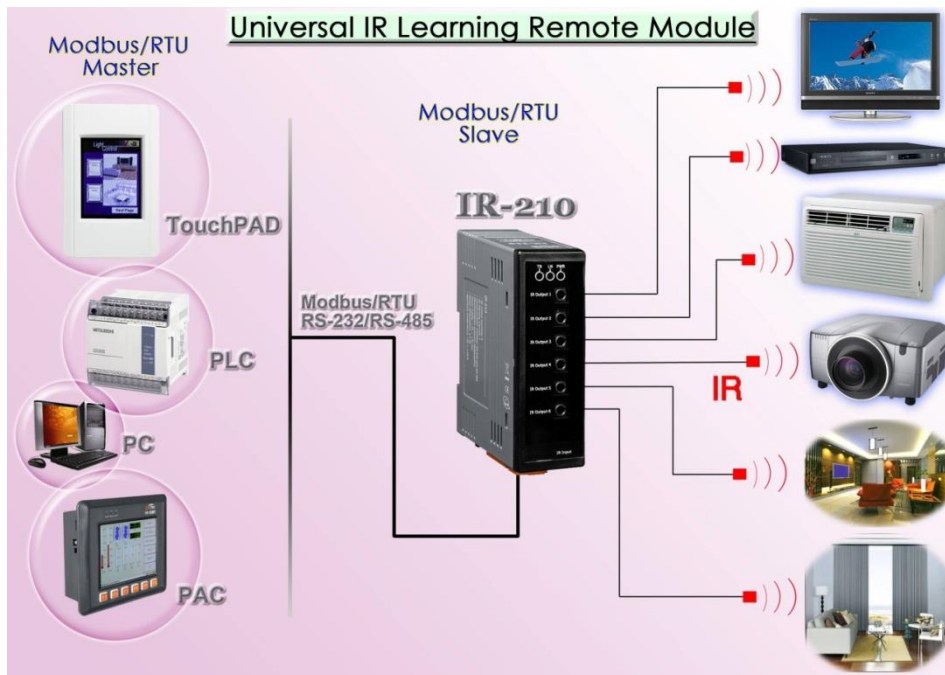

Figure 1-1 The basic application architecture of the IR-210.

---

## 1.1 Features

### [IR-210]

- 6 IR output channels for controlling multiple devices.
- 1 IR learning input.
- Supports 6 learning IR carrier frequencies: 33 、 36 、 37 、 38 、 40 and 56 kHz.
- Can learn and store 224 IR commands.
- Supports RS-232 and RS-485 serial interface.
- Supports Modbus/RTU protocol (FC6 and FC16).
- Assignable Modbus Network IDs: 1 ~ 247
- Baud rate settings: 9600, 19200, 38400, 57600 and 115200 bps.
- Configurable NONE / ODD / EVEN parity and 1 or 2 stop bits.
- Provides transmitting / learning / power indication LEDs.
- Built-in Watchdog.
- RoHS Compliance.

### [Utility]

- Configuration of IR command quantity.
- IR commands learning and testing.
- Save IR learning commands to files.
- Get / Set IR learning commands from / to IR-210.
- Reference to Modbus commands.
- Set / Reset basic settings of IR-210.
- Shows demodulated waveforms of IR commands.
- Supports Windows Vista/7/8/10 with .NET framework 4.5 platform.

## 1.2 Applications

- Home Entertainment Devices
- Video Conferencing System
- Surveillance System
- e-Classroom service
- Lighting Scenario Control
- Home and Building Automation

---

## 2. Hardware

### 2.1 Specifications

IR Interface		
IR Output Channels	6 channels with 3.5 mm audio jack	
IR Learning Input	1 channel. Supports 6 IR carrier frequencies: 33, 36, 37, 38, 40, 56 kHz.	
Serial Communication Interface		
Connector	2-pin (RS-485) / 5-pin (RS-232, Power) screw terminal connector	
COM1	RS-232 (TxD, RxD, GND)	
COM2	RS-485 (DATA+, DATA-)	
Baud Rate (bps)	9600, 19200, 38400, 57600, 115200	
Protocol	Modbus/RTU (slave)	
LED Indicator		
Round LED	TR (IR Transmitting) / LN (IR Learning) / PWR (Power)	
Power		
Power supply	+10 ~ +30 V <sub>DC</sub>	
Power Consumption	Stand By	0.65 W
	Using 1 IR Output	2.5 W
	Using 6 IR Outputs	12 W (Max.)
Dip Switch	FW (Firmware update mode) / OP (Firmware operation mode)	
Mechanical		
Installation	DIN-Rail Mounting	
Dimensions	33 mm x 78 mm x 107 mm (W x L x H)	
Environmental		
Operating Temperature	-25 °C ~ +75 °C	
Storage Temperature	-30 °C ~ +80 °C	
Humidity	10 ~ 90% RH, non-condensing	

## 2.2 Appearance

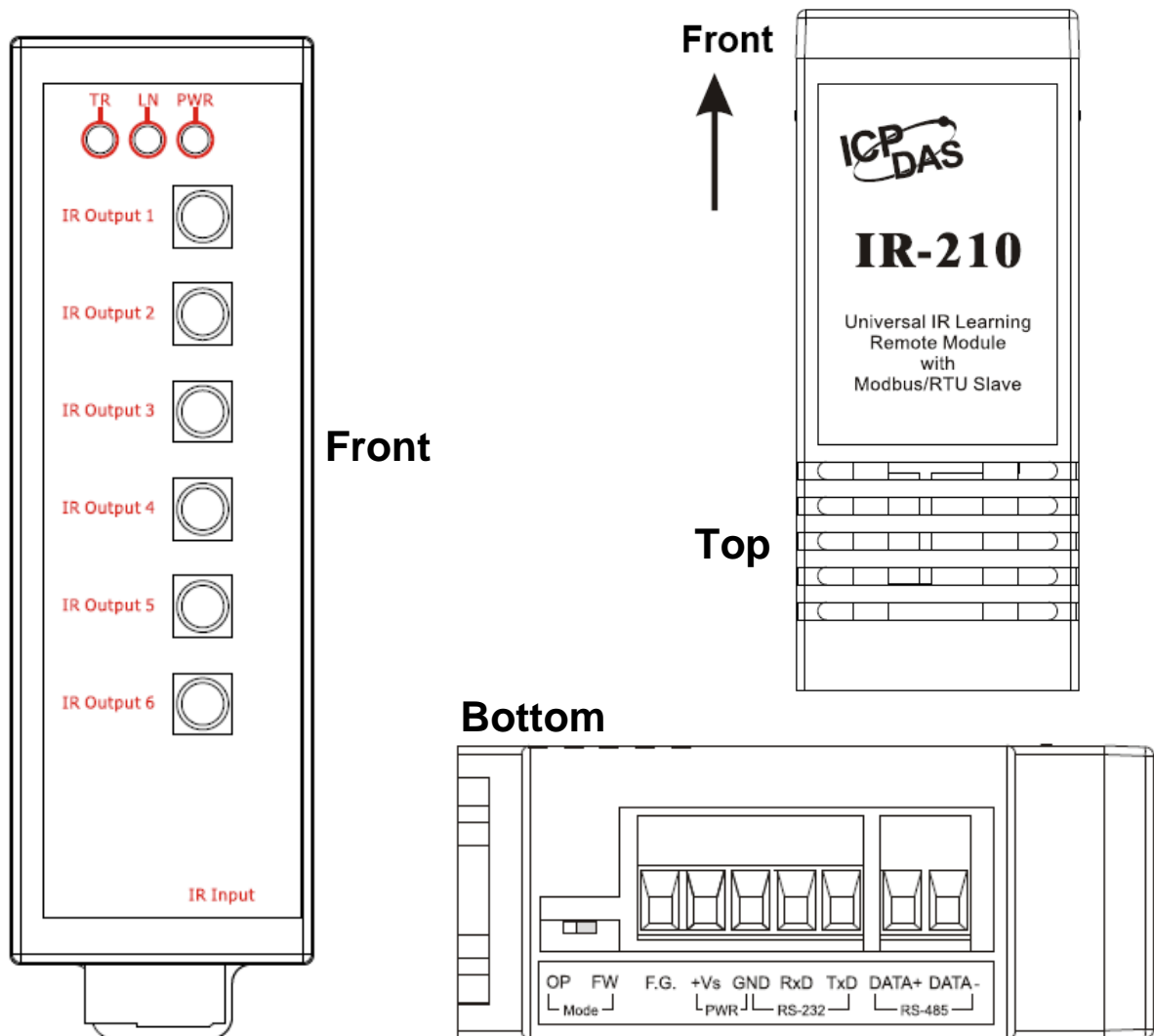

Figure 2-1 The appearance of the IR-210

## 2.3 Pin assignments

### ● The front panel

IR Output 1 ~ 6 : 3.5 mm audio jack

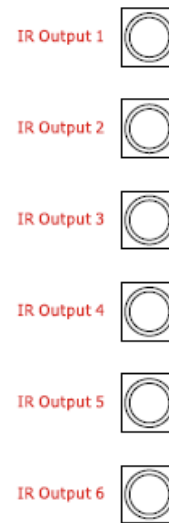

Figure 2-2 IR output 3.5 mm audio jack

### ● Communication terminal

Table 2-1 IR-210 terminal pin assignments

Screw terminal connector	
Interface	Pin
RS-485	RS-485 DATA-
	RS-485 DATA+
RS-232	RS-232 TxD
	RS-232 RxD
Ground	GND
Power	+Vs
Field Ground	F.G.

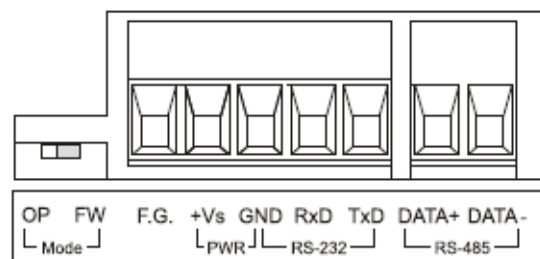

Figure 2-3 Communication terminal



---

## 2.4 Wire connection

The IR-210 supports 2 communication ports, RS-232 and RS-485 interfaces. Only one interface can be used at the same time (\*). 6 IR outputs on the front panel are 3.5 mm audio jacks for IR emitter cables.

### \* Note:

1) Before the firmware v1.14(included):

- Default serial interface is RS-232.
- Use IR utility to select RS-232 or RS-485 as the communication port.
- The TR LED indicates the current communication port after power-on within 3 seconds.

2) After the firmware v1.20(included):

- RS-232 and RS-485 port of the IR-210 can be used without the utility configuration. Though there is the setting item for the serial port in the IR utility, it won't affect the module.
- The TR LED blinking 3 times after power-on within 3 seconds is for the function of restoring to the default communication parameters.

### 2.4.1 RS-232 connection

The pin assignment of IR-210's RS-232 port is as figure 2-4.

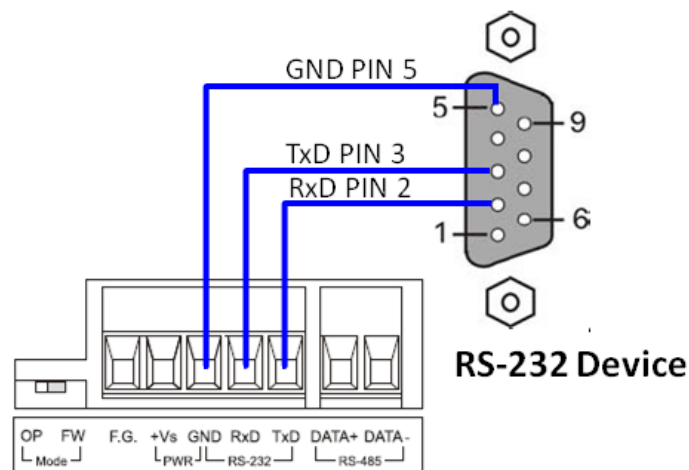

Figure 2-4 RS-232 connection

The following figure is using the attached cable (CA-0910) to apply in the RS-232 connection. If the host PC has no RS-232 port, the USB to RS-232 converters, I-7560 or I-7561 of ICP DAS, can be chosen to use.



Figure 2-5 RS-232 connection cable (CA-0910)

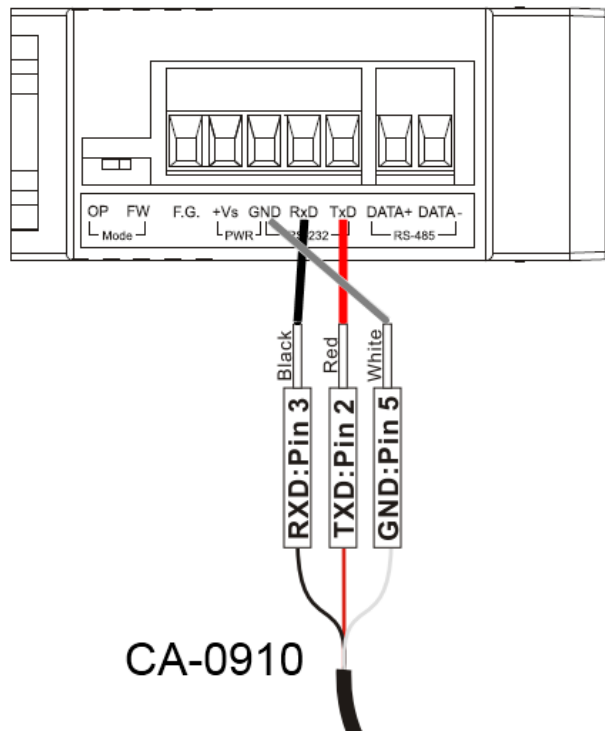

Figure 2-6 the connection between the CA-0910 and IR-210

### 2.4.2 RS-485 connection

The RS-485 connection between the IR-210 and RS-485 host device is as the figure 2-7.

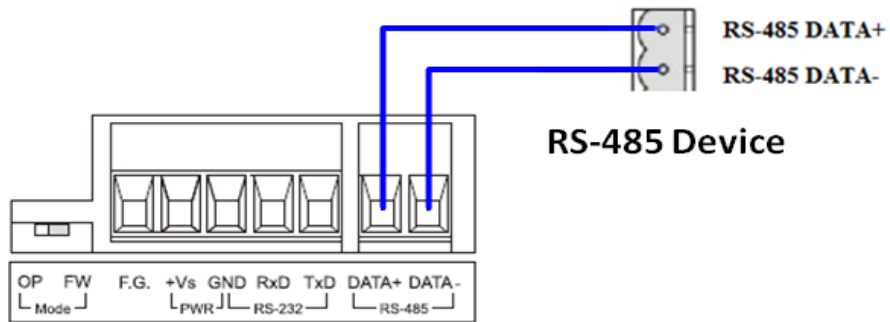
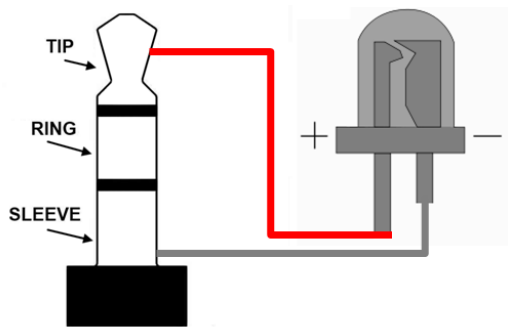

Figure 2-7 、 RS-485 connection

You can use the USB to RS-485 converter (tM-7561 or l-7561) in host PC to test the IR-210.

### 2.4.3 IR output

The front panel of the IR-210 has 6-ch IR outputs with 3.5 mm audio jack. The IR-210 supports TRS and TS connection jacks. The figure 2-8 shows the relation of IR output and TRS connector. The figure 2-9 shows the relation of IR output and TS connector.



TRS Connector IR LED  
Figure 2-8、TRS connection

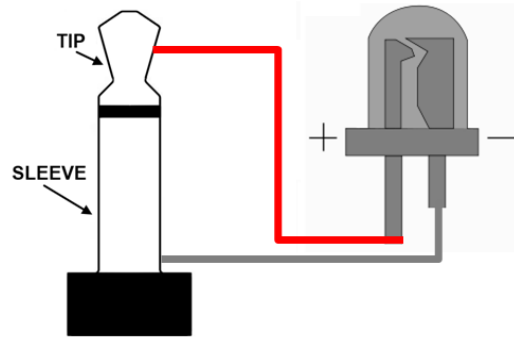

TS Connector IR LED  
Figure 2-9、TS connection

### 2.4.4 Power connection

The IR-210 supports +10~+30 VDC. The power connection is as the figure 2-10.

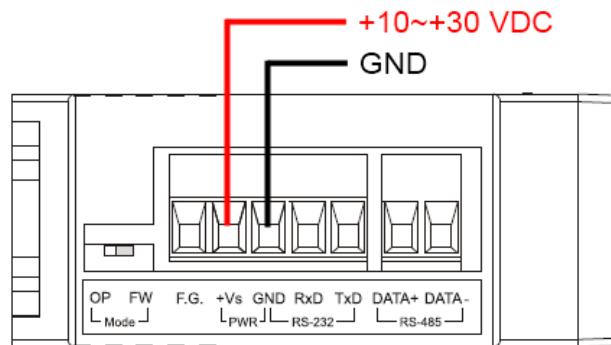

Figure 2-10、Power connection

---

## 2.5 Watchdog setting

The watchdog is the system inside timer to reset system due to some fault conditions in some ms. The watchdog of the IR-210 can be enabled or disabled by JP1. It is needed to open the case of the IR-210 to set JP1. The setting of JP1 is as the figure 2-11. The default setting of watchdog is enabled.

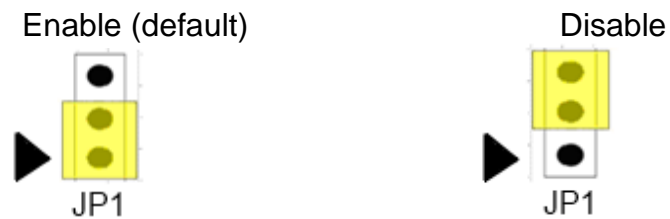

Figure 2-11 JP1 setting

---

## 2.6 Firmware Update DIP Switch

There is a switch in the bottom of the IR-210 to set the update firmware mode. The explanation is as follows.

### 2.6.1 Update firmware

Set the switch to “FW” and reset the power to let the IR-210 run into the update firmware mode. In the mode, you can use RS-232 port of the IR-210 to update firmware by CA-0910 cable as figure 2-13.

**Note:** After updating the firmware, remember to push the switch to “OP” mode and restart the IR-210 to run in operation mode.

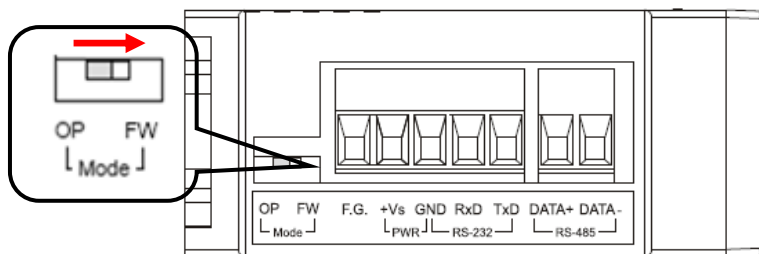

Figure 2-12 the FW mode in the switch

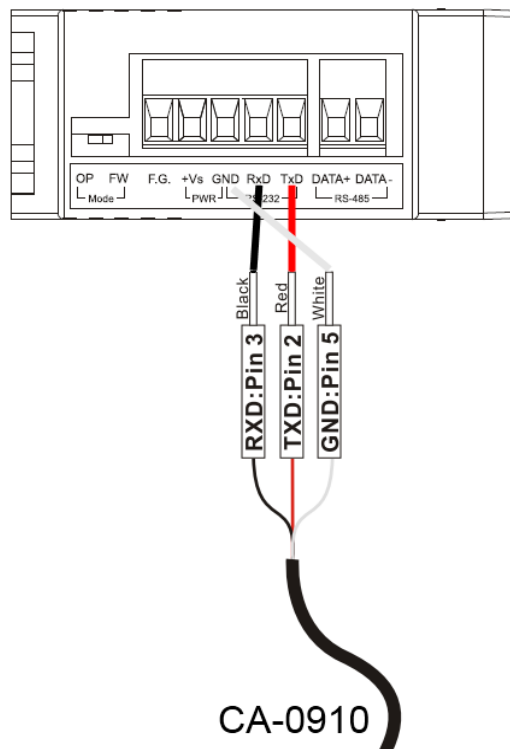

Figure 2-13 The download cable

For updating the firmware, you can click the menu [Tool] -> [Update Firmware to IR-210] to open the firmware update tool. According to the following steps, you can finish the update firmware procedure in the Fig. 2-14.

- (1) Select “COM” and “COM Port”
- (2) Click “Browser” to select the firmware.
- (3) Click “Firmware Update” to start the update procedure.

The result of the update would be shown in “Firmware Update” field.

**Note:** Firmware update would not change the serial communication settings and IR commands saved in the IR-210.

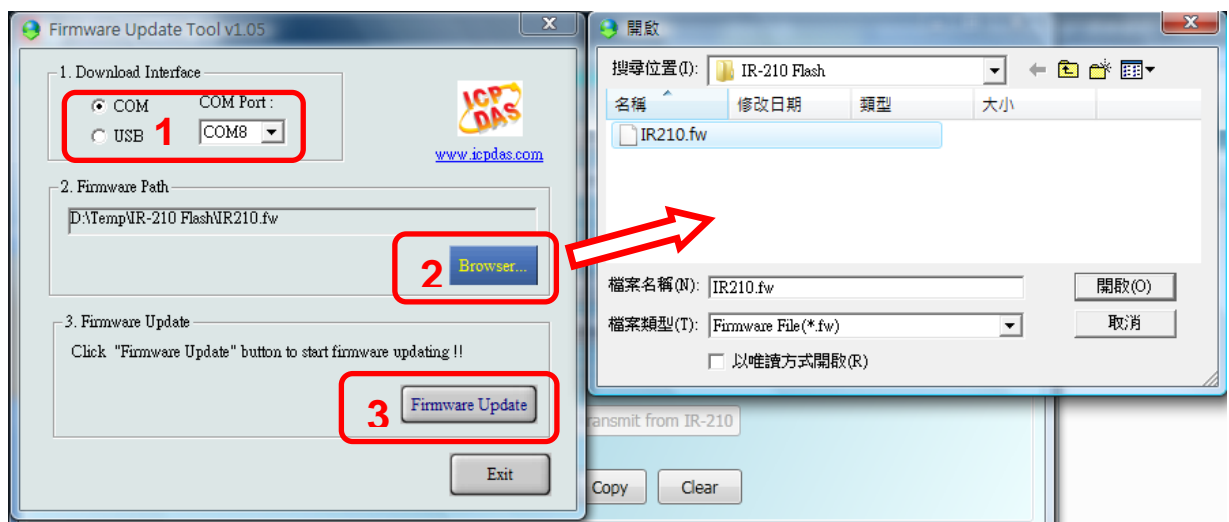

Fig. 2-14 、 Update firmware of IR-210

The firmware of IR-210 can be downloaded from:

<http://www.icpdas.com/en/download/show.php?num=2197&model=IR-210>

Firmware\_Update\_Tool can be launched in the IR utility.

IR-210 Utility [Menu]=>[Tool]=> [Update Firmware to IR-210]

## 2.6.2 Firmware operation mode

The firmware operation mode needs the switch to be set in “OP” mode in the figure 2-15 and power cycle the IR-210. In this mode, users can set the parameters, learn IR commands and receive Modbus commands via the COM port of the IR-210.

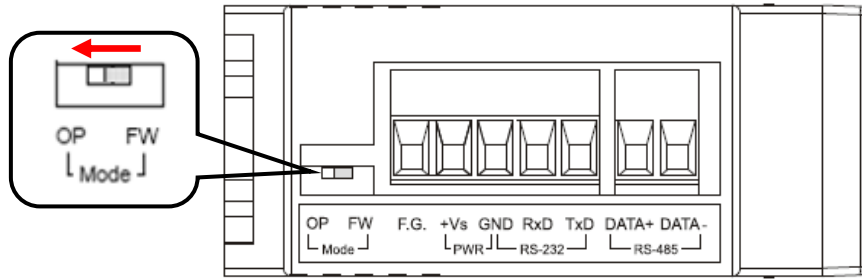

Figure 2-15 Set the switch to “OP” mode



---

## 2.7 LED Indicators

There are three LEDs in the IR-210 to show three states. The meanings of these states would be introduced below.

### (1) PWR LED :

This LED would turn on always when the IR-210 is normal.

### (2) LN LED :

This LED represents the learning mode of IR-210. When this LED is on, it shows the IR-210 is in learning mode. It would wait for the appliance controller to emit the IR signal. When finishing learning the IR command, the LED would turn off.

### (3) TR LED :

This LED represents the IR output state or communication interface in the initial procedure. When the LED is turning on, it shows the IR-210 is emitting the IR signal. Besides, when power on, this LED flashes three times and turns off in three seconds. It shows the IR-210 is using RS-232 port to communicate with outside. If the LED is turning on in three seconds and turning off, it shows the communication port is RS-485.

Table 2-2 The description of LEDs for IR-210

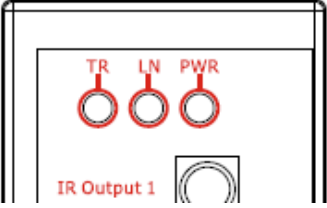
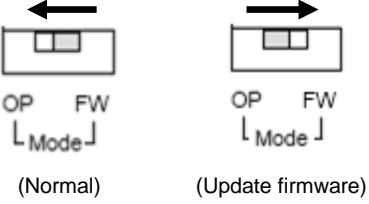
LED	Description	Note
TR flashes three times when power on	Communication port is RS-232 port. (*)	
TR is on for 3 secs when power on	Communication port is RS-485 port. (*)	
TR on	IR channels are emitting IR signal	
TR flashes weakly	Serial port communication	
LN on	Learning mode to receive IR remote signal	
LN off	Finish receiving IR remote signal	
PWR on /off	Normal / Fault	
TR, LN off ; PWR on	Operation mode	<p>Set the switch to “OP” or “FW” mode and reset the power.</p> 
TR, LN, PWR on	Update firmware mode	

\* Please refer to the section 2-4.

---

## 3. Software

### 3.1 The configuration tool– IR Utility

IR Utility is used for setting the IR series modules. It is the .NET Framework 4.5 based program on Microsoft OS. IR-210 utility, contained in the IR utility, is for IR-210 to set up parameters and learning IR commands. Users can download the IR Utility (IR\_Util\_Setup\_v#\_#\_#\_#.zip) from:

<http://www.icpdas.com/en/download/show.php?num=2102&model=IR-210>

If the environment of .NET Framework 4.5 is not available on the Microsoft OS, the setup package will download and install the redistribution automatically. The redistribution package can also be downloaded from the following link:

<https://www.microsoft.com/en-US/download/details.aspx?id=30653>

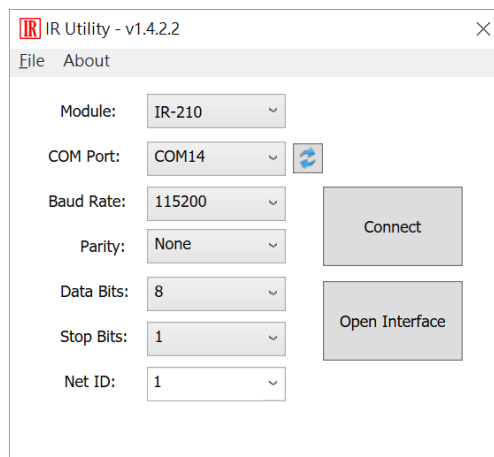

### 3.2 IR-210 Utility

IR utility can be launched from [Start] → [ICPDAS] → [IR Utility]. The main window is shown in figure 3-1. Select “IR-210” in the Module and click “Connect” button to connect to the IR-210. The main window of the IR-210 utility will appear after connection.

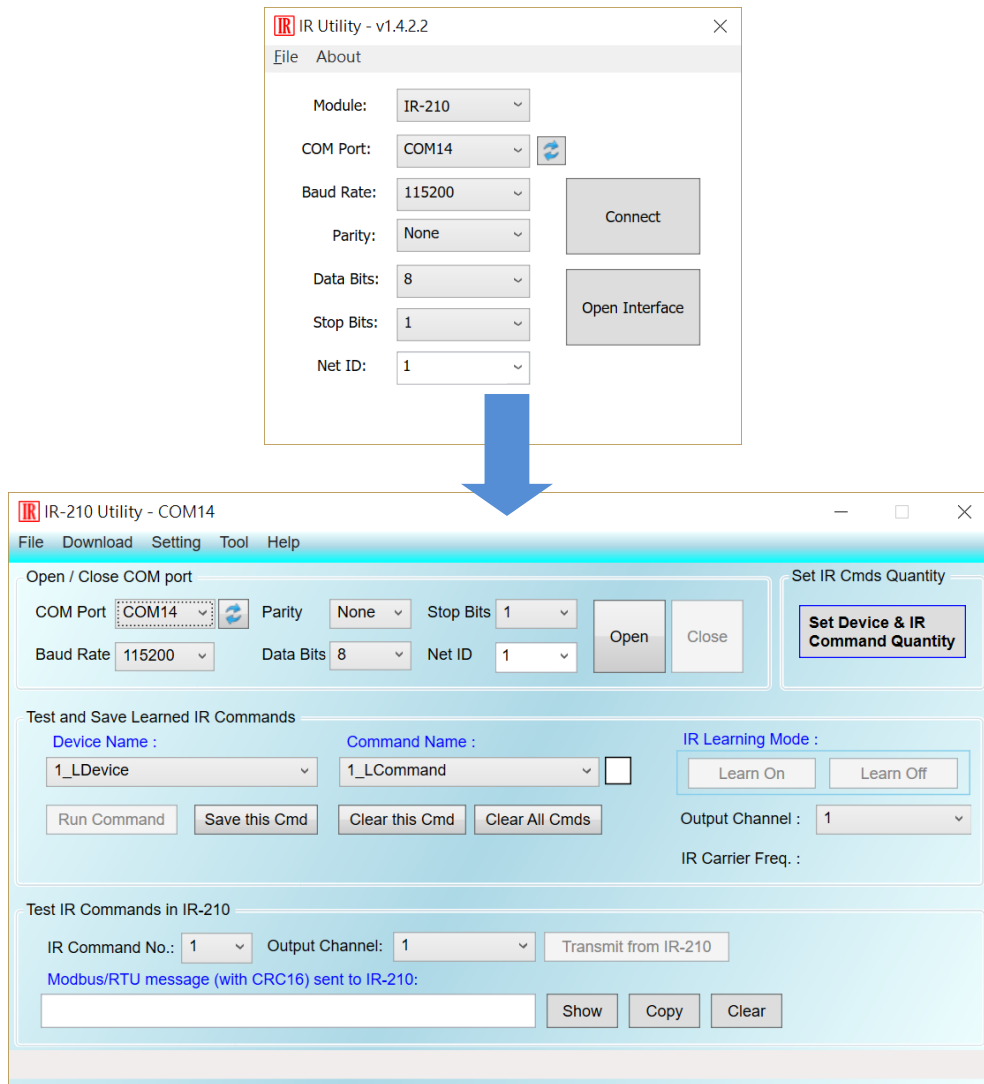

Figure 3-1 Main windows of IR utility and IR-210 utility

---

### 3.2.1 Menu

Table 3-1 explains the menu of the IR-210 Utility.

Table 3-1 The items of menu.

Item	Sub item	Description
File	Load IR Commands from File	Load the IR command file to the utility.
	Unload IR Commands	Unload the IR commands from the utility.
	Save IR Commands to File	Save the IR command to the defined file from the utility.
	Copy IR Cmds from File	Copy IR commands from IR learning data file.
	Exit	Close the IR-210 utility.
Download	Download IR Commands to IR-210	Download the temporary IR commands of the utility to the flash memory of IR-210.
	Load IR Commands from IR-210	Load the temporary IR commands from the flash memory to the utility.
Setting	IR-210 Basic Settings	The basic settings of the IR-210.
	Reset Basic Settings on IR-210	Reset the basic settings.
Tool	Update Firmware to IR-210	This function provides users to update the firmware of the IR-210.
	Waveform of IR Commands	Show demodulated waveform of IR commands.
Help	About IR-210 Utility	The information of the IR-210.

#### (1) File

- **Load IR Command from File**

The saved file name is \*.ird which includes the information of the learned IR commands. Click this item would pop up the window for users to select the saved file. Then, the IR commands would be downloaded to the utility.

- **Unload IR Commands**

This function would clear the temporary IR commands from the utility. The “Device Name” and “Command Name” list in “Test and Save Learning Commands” field would be recovered to the default values

- **Save IR Commands to File**

This function provides a dialog to save the temporary IR commands as the defined file.

---

- **Copy IR Cmds from File**

Copy IR commands from an IR learning data file to the IR-210 utility. It can save the time to learn IR commands again. IR learning data files of IR-210/IR-712A/IR-712-MTCP are not recommended to be used to on unmatched modules. Please refer to section [3.2.6](#) for the detailed description.

- **Exit**

Exit and close the IR-210 utility.

## (2) Download

- **Download IR Commands to IR-210**

This function can save the temporary IR commands to the flash memory of the IR-210. That would appear the window to show the download information as the figure 3-2. After finishing the procedure, this window would close.

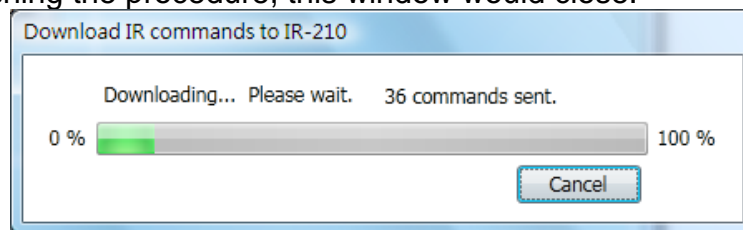

Figure 3-2 Download the IR commands to the IR-210.

- **Load IR Commands from IR-210**

The item provides the function to load the IR commands to the utility from IR-210's flash memory. That would appear the window to show the download information as the figure 3-3. After finishing the procedure, this window would close.

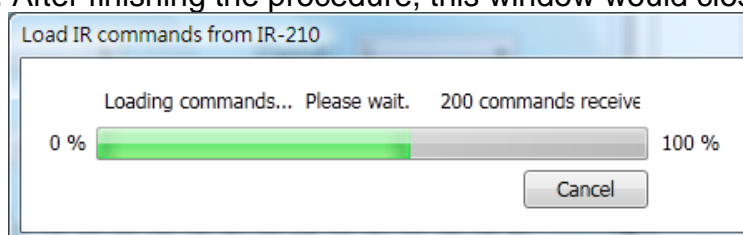

Figure 3-3 Load the IR commands from the IR-210.

## (3) Setting

- **IR-210 Basic Settings**

This function can show or set the basic information of IR-210 as the figure 3-4.

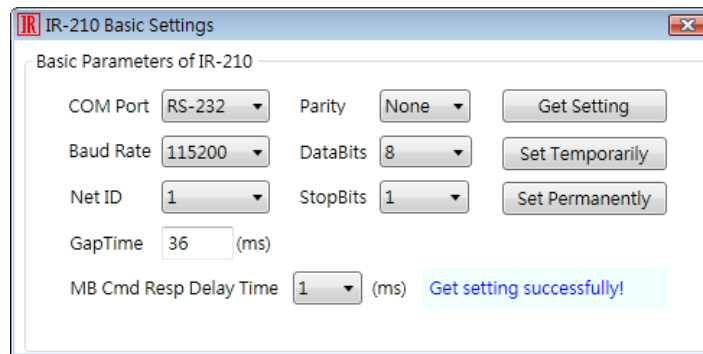

Figure 3-4 The basic setting of the IR-210.

These settings include:

- [1] **COM Port** : The COM port of the IR-210  
(RS-232/RS-485, default :RS-232) (\*)
- [2] **Baud Rate** : The baud rate of the COM port  
(9600~115200 bps , default: 115200)
- [3] **Parity** : Parity bit (NONE / ODD / EVEN , default : NONE)
- [4] **Data Bits** : Data bit (This value is fixed in 8)
- [5] **Stop Bits** : Stop bit (1 / 2, default:1)
- [6] **Net ID** : Modbus Net ID  
(1~247, default:1)
- [7] **GapTime** : The max interval time in the IR signals (figure 3-5). For example:  
increasing the time would have the better learning performance In  
Sharp remote controller. (6 ~ 200 ms, default : 72 ms)

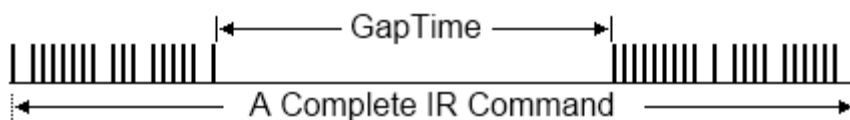

Figure 3-5 A complete IR Command with a gat time

- [8] **MB Cmd Resp Delay Time:** The delay time before the IR-210 responses each  
request from the Modbus master devices (Modbus command  
response delay time: 0 ~ 60 ms; default: 3 ms)

\* **Note:** Please refer to the section 2-4.

The “Get Setting” button will be executed once when the “Basic Settings” window is opened in the beginning. Three buttons located at the right side of the window are described in the Table 3-2.

**Table 3-2:** Three buttons in the window of basic settings

Button Name	Description
Get Setting	Get the current basic parameter settings of the IR-210.
Set Temporarily	Set the settings of IR-210 to the parameters selected in the window temporarily. Cycling the power will restore the IR-210 to previous settings.
Set Permanently	Set the settings of the IR-210 to the parameters selected in the window. IR-210 will retain the settings after power cycling.

### • Reset Basic Settings on IR-210

If the connection to IR-210 is failed and the record of communication settings is unavailable, click this item to open the resetting interface as depicted in fig. 3-6. The steps of resetting are as follows:

- (1) Connect PC to the RS-232 port of IR-210 and click “Open” button in the utility to open COM port.
- (2) Power off and power on IR-210. Click Reset button within 3 seconds after power on.
- (3) A dialog as Fig. 3-7 shows that the resetting to default values is done. Please note that the parameters resetting is temporary. Please go to “IR-210 Basic Settings” interface and click “Set Permanently” button to confirm the settings.

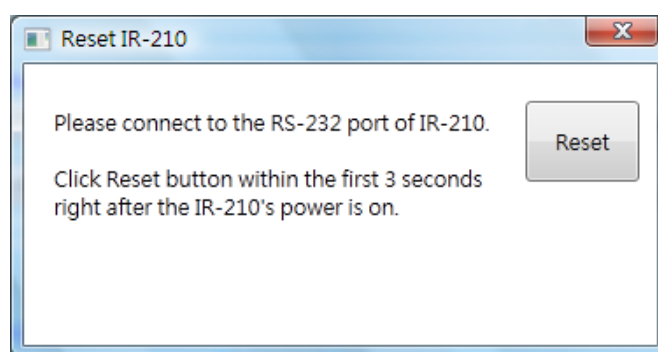

Fig. 3-6 Reset IR-210 interface

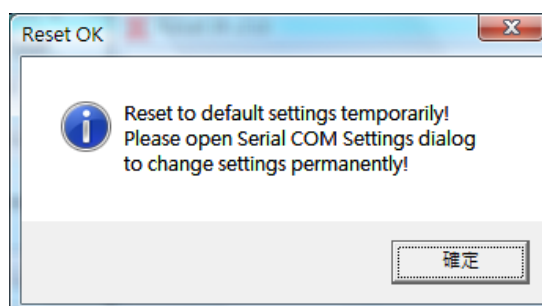

Fig. 3-7 Reset to default settings temporarily



---

#### (4) Tool

- **Update Firmware to IR-210**

Open the “Update firmware” window. You can know the detail as section [2.6.1](#).

- **Waveform of IR Commands**

Indicate the demodulated IR waveforma of the IR commands. Please refer to section [3.2.7](#) for the details. ◦

#### (5) Help

- About IR-210 Utility

This function can shows the information of IR-210. The firmware version would be shown correctly if the communication is normal to the IR-210.

### 3.2.2 Open/Close COM port

This field can set the communication parameters of COM port of the host PC to the IR-210. Before communicating with the IR-210, make sure the wire connection is correct, and these settings are the same with ones in the IR-210.



Figure 3-8 Open/Close COM section

These settings are explained as follows:

[1] **COM Port** : The COM port of IR-210 (RS-232/RS-485, default :RS-232) (\*)

[2] **Baud Rate** : The baud rate of the COM port (9600~115200 bps , default: 115200)

[3] **Parity** : Parity bit (NONE / ODD / EVEN , default : NONE)

[4] **Data Bits** : Data bit (This value is always 8)

[5] **Stop Bits** : Stop bit (1 / 2, default:1)

[6] **Net ID** : Modbus Net ID (1~247, default:1)

\* **Note:** Please refer to the section 2-4.

---

### 3.2.3 Set Device & IR Command Quantity

The IR device & command quantity for learning can be configured in this interface. Please click “Set Device & IR Command Quantity” button (Fig. 3-9) to set them up in three steps (Fig. 3-10 ~ Fig. 3-13).

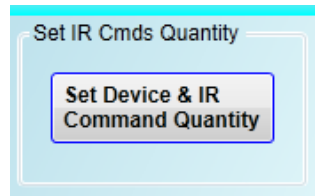

Figure 3-9 Configure IR command quantity for learning.

- Step 1 : Set the number of the IR devices

The max number of controlled devices is 11. This function is convenient for users to manager these IR commands as various groups as the figure 3-10.

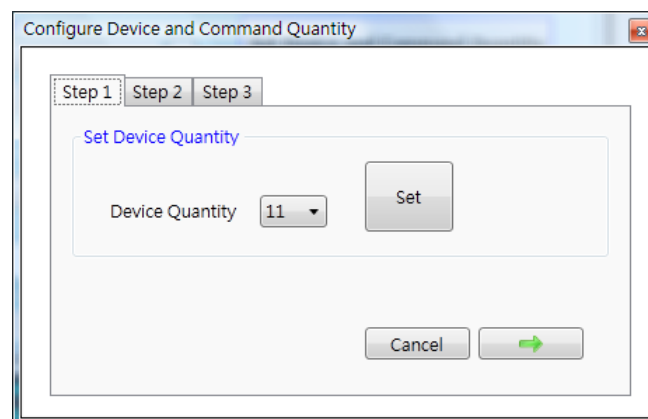

Figure 3-10 The quantity setting of the device (Step1)

- Step 2 : Define the device name and set the number of the IR command

This step can set the name of the planned devices and the quantity of the IR command. The former of the name is the number of the device. The quantity of the IR command cannot be over 224. When the number is over 224, the utility would pop up a warning dialog and shows the remnant number as the figure 3-12.

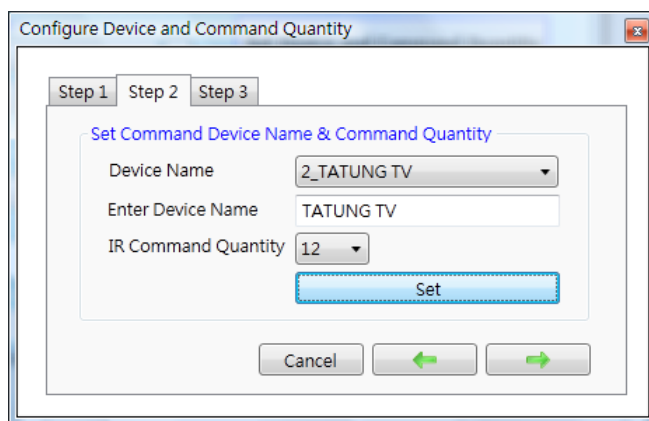

Figure 3-11 Define the name and the quantity of the IR commands (Step2)

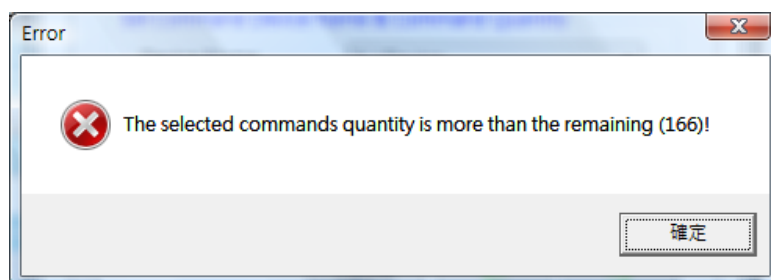

Figure 3-12 The warning dialog

- Step 3 : Define the IR command name

This step can define the IR command name according to your need. It is convenient to know the IR command function. The former of the name is the number of the IR command. It can be the command reference of the inside IR-210.



Figure 3-13 Define the name of the IR commands (Step3)

---

### 3.2.4 Test and Save Learned Commands

This interface provides the function to enable IR learning mode, IR learning information and test the learned IR commands as the figure 3-14.



Figure 3-14 Test & save learned IR commands interface

#### ➤ IR Learning Mode

This interface as the figure 3-15 provides “Learn On” and “Learn Off” buttons. After clicking “Learn On” button, the IR-210 would turn into IR learning mode and the LN LED turns on to wait for the controller’s IR signal. The “Learn Off” would release the IR learning mode.

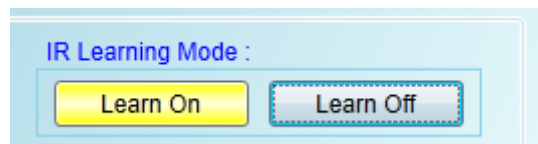

Figure 3-15 Enable/Disable IR learning mode

#### ➤ Test and Save Learned Commands

The functions in this interface are described as follows:



Fig. 3-16 Test & save IR commands interface

- Device Name / Command Name list

In “Device Name” and “Command Name” lists, you can review the IR command setting result. And, users can start to learn and test IR commands according to this plan setting.

- IR command learning state

The rectangular graph in the left of “Command Name” field as the figure 3-17 shows

the learned state of this IR command. The different color shows the different state as follows:

Table 3-2 Description of the state of IR command storage

Color	Description
Red	Shows the IR learned command has been saved in the “Command Name” field
Yellow	Get the IR learned command temporarily. If other command name item has been selected, the data would disappear.
White	The IR command has no any the learned information.

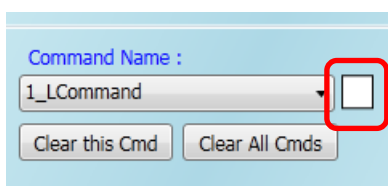

Figure 3-17 The IR learning state dialog

- Run Command

When finishing learning IR command, users can test this IR command from the IR-210 by clicking “Run Command”. The IR output channels are defined by “Output Channel” list.

- Save this Cmd

This function can save this learned IR command into the Utility. When finishing all the learned commands, selecting [File]->[Save IR Commands to File] can save to the backup file.

- Clear this Cmd

Clicking “Clear this Cmd” button can remove the learned IR command in the Utility from the selected command.

- Clear All Cmds

This button can clear all the learned IR commands in the Utility. The device and command names would not be changed. However, selecting [File]-[Unload IR Commands] will clear all commands and change the names and quantity of the device and IR command to the default values.

---

- Output Channel

The “Output Channel” list can define the IR output channels when test the learned commands.

### 3.2.5 Test the IR commands in IR-210

This section (Fig. 3-18) can help users to test the IR commands saved in the IR-210 after downloading IR commands to IR-210. Click the “Transmit from IR-210” button to send a Modbus command to the IR-210 with specified IR command number and IR output channel. Meanwhile, a Modbus/RTU command text for reference is shown underneath. Users can click “Copy” button to copy the Modbus command to the clipboard and use it in programming their applications.

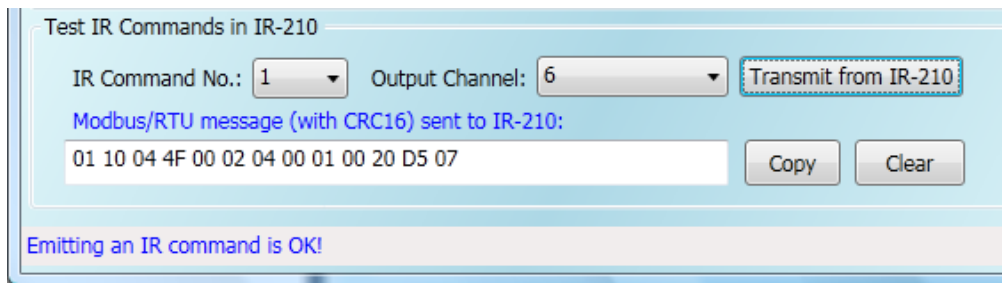

Figure 3-18 Test IR commands saved in IR-210.

### 3.2.6 Copy IR Commands from File

Click Menu [File]->[Copy IR Cmds from File] to open the copy window as shown in Figure 3-19. Please follow the steps in the Figure 3-20 to copy the IR commands.

- 1) Browse and load the source IR learning data file.
- 2) Select the device name of the source IR data file.
- 3) Select the desired IR commands for copy. Use “keyboard Ctrl” + “mouse left” buttons or “keyboard Shift”+ “mouse left” to select multiple source IR commands.
- 4) Select the current Device Name.
- 5) Select the destination start position of IR commands for copy.
- 6) Click the middle copy (“>>”) button.

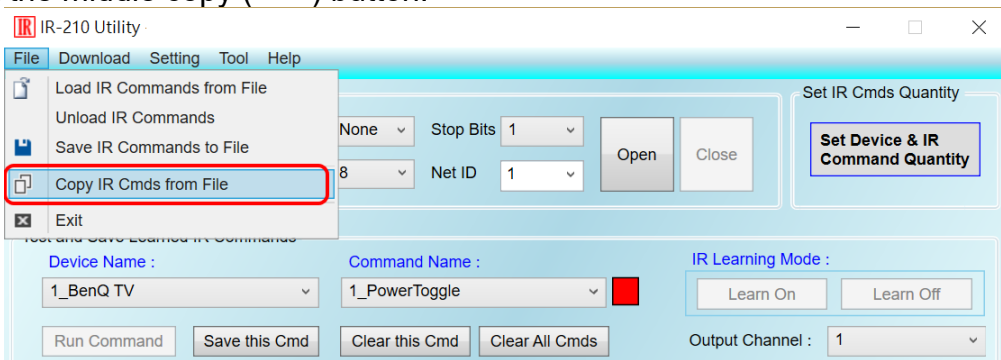

Figure 3-19 Open window for copying IR commands.

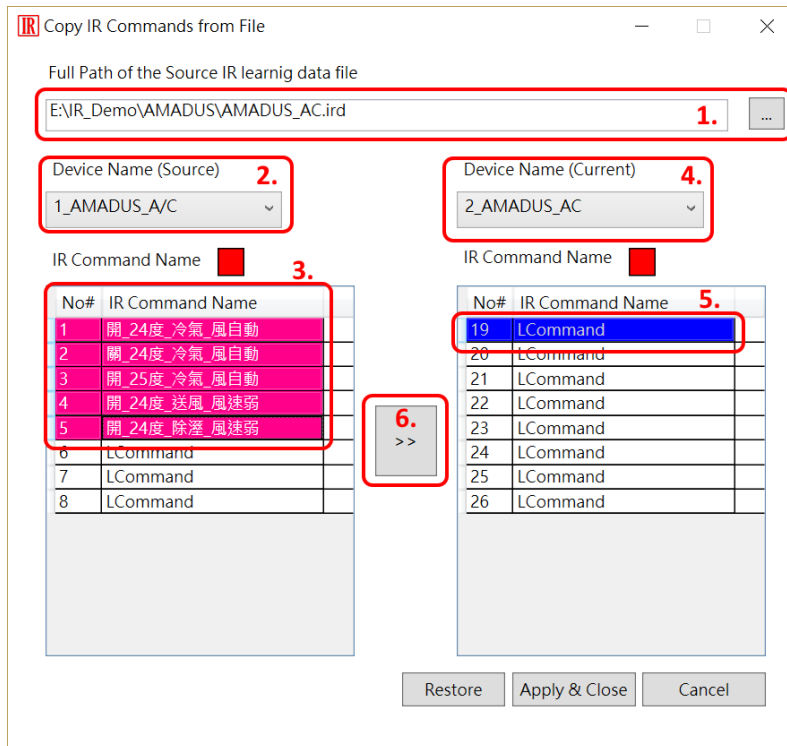

Figure 3-20 Window for copying IR commands.

Next, click “Apply & Close” button (Figure 3-21) to finish the copy procedure. The IR commands are copied to the IR utility as shown in the Figure 3-22.

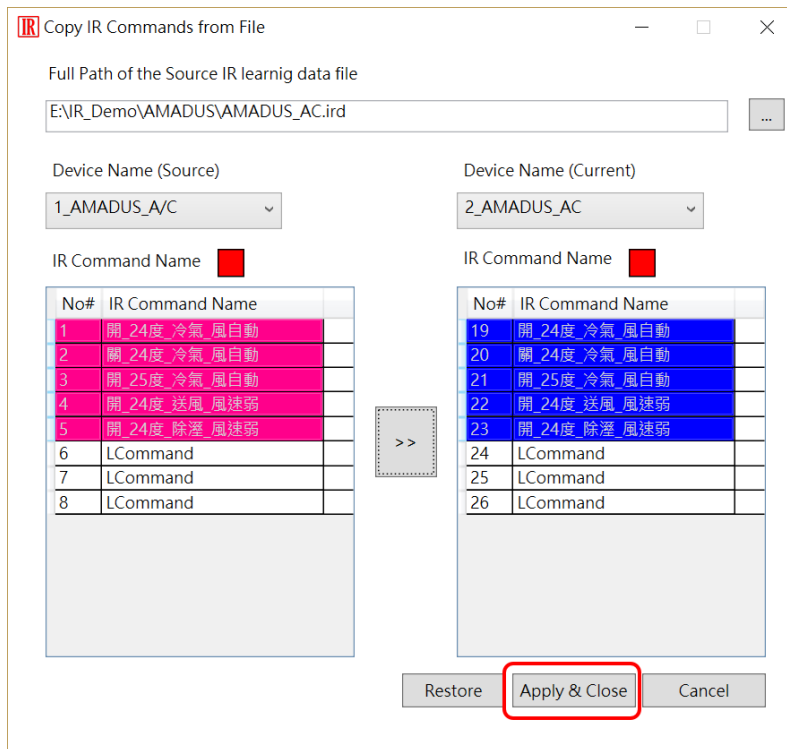

Figure 3-21 Copy IR commands to current device.

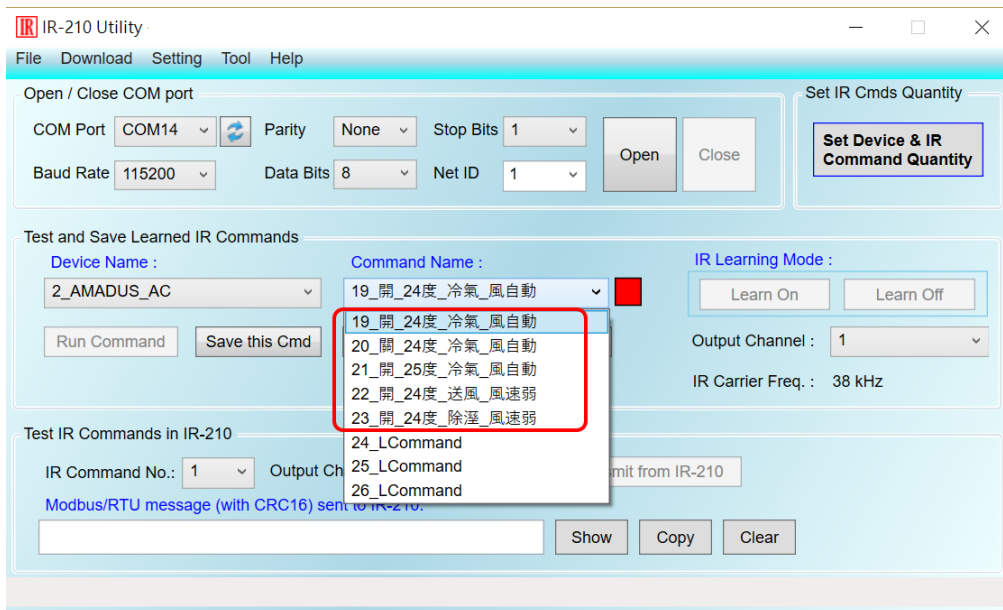

Figure 3-22 IR commands are copied to the IR utility.



### 3.2.7 Display Waveforms of IR Commands

Click the menu [Tool]->[Waveform of IR Commands] to open the window for demodulated waveform display of an IR command in the “Command Name” combo box as shown in Figure 3-23. When the other IR command is selected or a new IR command is learned, the IR waveform will appear at the upper position and the previous IR waveform is moved to the lower position (Figure 3-24).

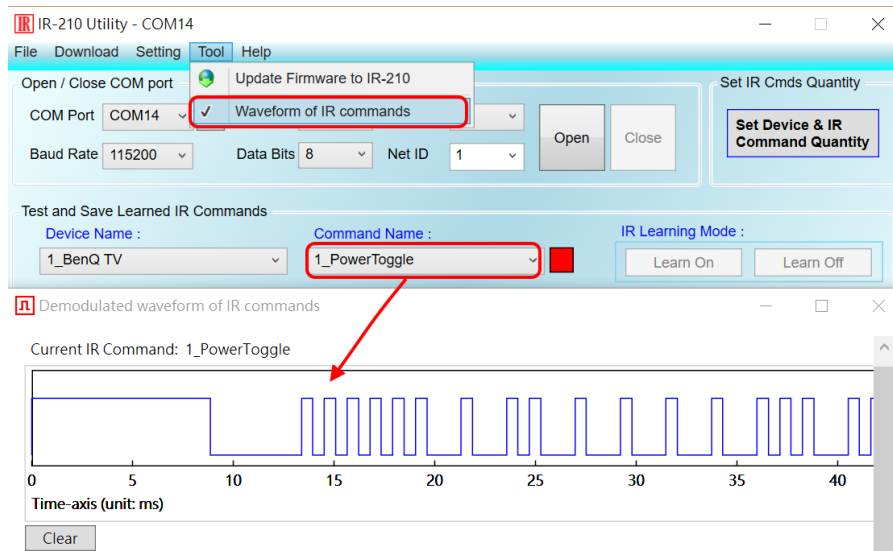

Figure 3-23 Opened waveform window shows current IR command.



Figure 3-24 Previous IR waveform is at underneath position.

---

## 4. Learning IR command Example

Follow these steps in this chapter to operate the IR-210 correctly. And you can understand how to set and use the IR-210. Before learning this example, you need to check the connection between the IR-210 to the host PC is correct.

### 4.1 IR-210 communication settings

The default communication parameters of the IR-210 are as follows:

Table 4-1 IR-210 default settings for serial communication.

Item	Default
COM port	RS-232 (*)
Baud rate	115200 bps
Parity	None
Data bits	8
Stop bits	1
Modbus ID	1

\* **Note:** Please refer to the section 2-4.

In the main window, select the COM port of the host PC to connect to the IR-210. Then, click “Open” to open the COM port of the host PC. If the opening COM is successful, the “open” button would be disabled.



**Figure 4-1** Open the COM port of the Host PC.

## 4.2 Configure the quantity of the IR-controlled devices and IR commands

Click the “Set Device & IR Command Quantity” button at top-right corner (Fig. 4-2) to open the configuration dialog. Follow three steps below to finish the configuration of the devices and IR commands quantity in advance of the next IR learning.

**Step 1 :** Set the quantity of the IR-controlled devices as shown in fig. 4-3.

**Step 2 :** Set the device name and the quantity of the IR commands as the fig. 4-4.

**Step 3 :** Set the IR command names as depicted in fig. 4-5.

The prefix numbers of these IR command names (e.g. 1\_Play) represent the numbers of 224 IR commands saved in the IR-210 module. They will be used as IR command number in the Modbus command for communication with IR-210.

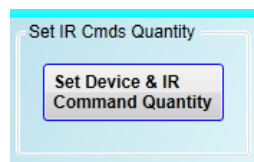

**Figure 4-2** The button for configuration of IR command quantity.

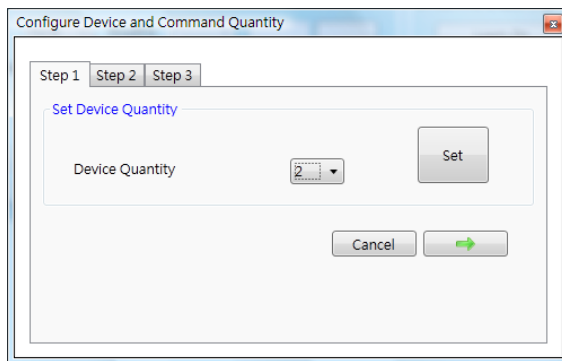

**Figure 4-3** Set Device quantity.



**Figure 4-4** Set device names & IR cmd quantity.

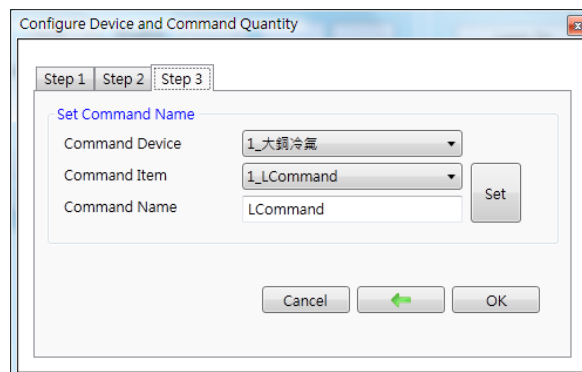

**Figure 4-5** Set names of IR commands.

### 4.3 Learning and testing IR commands

Follow the steps below and the illustration in fig. 4-6 to learn and test IR commands:

- (1) Determine the IR command for learning by selecting the items in the “Device Name” and “Command Name” comboboxes.
- (2) Click the “Learn On” button to enable the IR learning mode on IR-210. At the same time, the LN LED is turned on to show the state.
- (3) Aim the IR emitter head of the device’s remote control at the IR input of IR-210. The distance less than 3 cm between the remote control and the IR-210 would be best. Then, press the button of the remote control which is to be learned. If the learning for the IR command is finished, the LN LED will be turned off and the IR learning data will be sent back to the Utility.
- (4) Select the IR output channel. For example in the fig. 4-6, the IR output channel is 1.
- (5) Aim the head of the IR emitter cable plugged in the IR output 1 at the corresponding IR-controlled appliance. Click “Run Command” button to emit the IR command from the IR-210. You can check if the learned IR command is OK by investigate the action of the appliance. If not, please repeat step 2 and step 3 again.
- (6) Click “Save this Cmd” button to save this IR learning command to the current item of the “Command Name” combobox, e.g. the item is “Play” in fig. 4-6.

Repeat the above steps to learn all the IR commands.

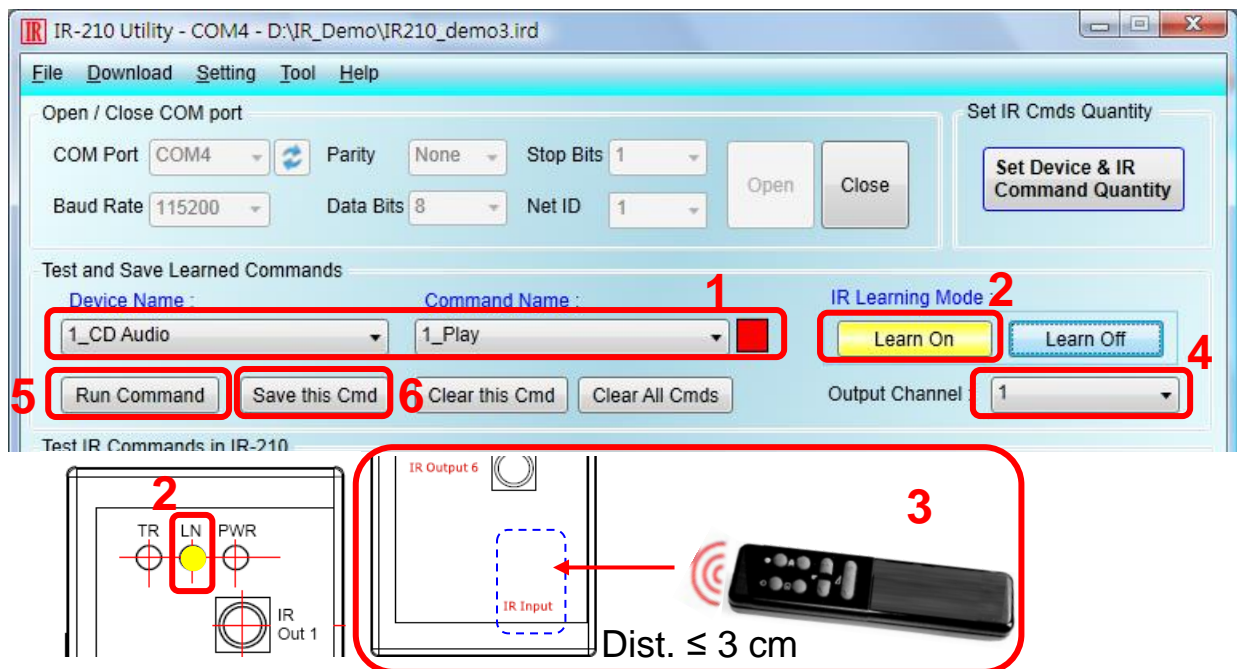

Figure 4-6 The steps to learn IR commands

---

When the IR learning process is finished, it is advised to save these learning data into a file for backup by clicking [File] in menu. Besides, it is necessary to download these learned IR commands to the IR-210 for remote control application by selecting [Download] in menu.

#### 4.4 Saving the Learned IR Commands to a File

Click [File]->[Save IR commands to file] to save the learned IR commands as a file. The extension of the file name is \*.ird.

#### 4.5 Download the IR Learning Commands to the IR-210

After the learning IR command procedure or loading learning data from the file, it is necessary to download these learning data to the IR-210 by clicking [Download]->[Download IR Commands to IR-210] in the menu and a progress window will popup as shown in fig. 4-7.

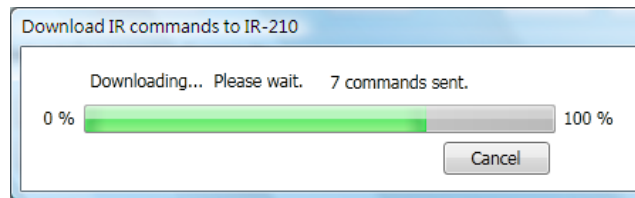
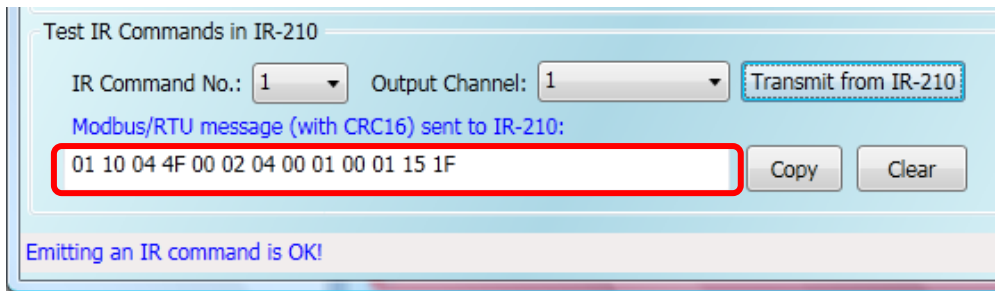

**Figure 4-7** Download the learned IR command to the IR-210.

#### 4.6 Test the IR commands saved in the IR-210

The “Test IR Commands in IR-210” section can help users to test the learned IR commands saved in the IR-210 as shown in fig. 4-8. By clicking “Transmit from IR-210” button, the specified IR command (the prefix no. mentioned in 4.2) would be emitted from the selected output channel of the IR-210. You can check if the learned IR command is correct in this way.

At the same time, the Modbus RTU message sent to IR-210 is shown in the textbox underneath. This Modbus message is a reference for users to help program the application to control IR-210.



**Figure 4-8** Test the IR commands saved in the IR-210

## 4.7 Load the IR Learning Commands from the File

Select [File]->[Load IR Commands from File] in the menu to load IR learning data into the IR-210 Utility from the \*.ird files.

## 4.8 Load IR Learning Commands from the IR-210

Select [Download]->[Load IR Commands from IR-210] in the menu to load the IR commands from the IR-210. A progress window will pop up as shown in fig. 4-9.

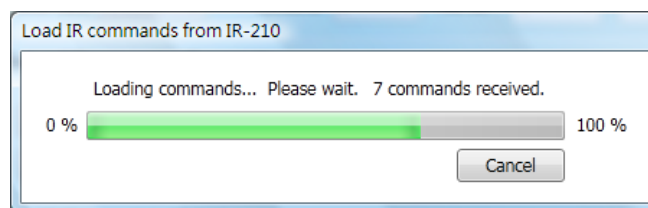

**Figure 4-9** Load the IR commands from the IR-210

## 5. Modbus Registers Addresses

Table 5-1 is the description of the Modbus/RTU holding registers (4xxxx) for IR-210. The Modbus master device can send Modbus commands to the IR-210 to emit the IR commands from the output channels. A reference to Modbus FC16 commands is also provided by the IR-210 Utility, which was described in 3.2.5. The function codes (FC) of Modbus to write data to Modbus registers are 6 and 16. Each Modbus address occupies 2 bytes.

**Table 5-1** Modbus Holding Registers

Start Address [4xxxx]	Description
1103 (0x44F) [41104]	The number of IR command (1 ~ 224)
1104 (0x450) [41105]	IR output channels Settable value: 0x01 ~ 0x3F ◦ The first bit (LSB) of the value represents the 1 <sup>st</sup> channel. The 6 <sup>th</sup> bit represents the 6 <sup>th</sup> channel. Example : <ul style="list-style-type: none"> <li>• The 1<sup>st</sup> output channel : 0x01 == <u>00 0001</u> (Binary)</li> <li>• The 1<sup>st</sup> , 2<sup>nd</sup> and 6<sup>th</sup> output channels : 0x23 == <u>10 0011</u></li> </ul>

Table 5-1 is the example of Modbus FC16 command to emit IR signal from the IR-210. (Modbus ID:1, the IR command No.:1, output channel:6)

**Table 5-2** An example of Modbus FC16 command (Hex value)

Net ID	FC(*)	Start Addr.	Word Count	Byte Count	IR Cmd No.	Output Ch.	CRC16
<u>01</u>	<u>10</u>	<u>04 4F</u>	<u>00 02</u>	<u>04</u>	<u>00 01</u>	<u>00 20</u>	<u>D5 07</u>

\*FC is the abbreviation of Function Code.

The following is an example of using Modbus FC6 commands for IR-210, where [41104] and [41105] should be written sequentially. (Modbus ID:1, the IR command No.:1, output channel:6)

**Table 5-3** An example of Modbus FC6 command (Hex value)

Net ID	FC	Start Addr.	IR Cmd No.	CRC16
<u>01</u>	<u>06</u>	<u>04 4F</u>	<u>00 01</u>	<u>78 ED</u>
Net ID	FC	Start Addr.	IR Cmd No.	CRC16
<u>01</u>	<u>06</u>	<u>04 50</u>	<u>00 20</u>	<u>89 33</u>

## 6. ASCII String Command

ASCII string command (DCON protocol) for emitting the IR commands.

**Table 6-1** ASCII String Command

Command	Response	Description
#AA0+xx.yyy	>	<p><b>[Request]</b>            #: leading character '#'            AA: Module ID (hexadecimal) = Modbus Net ID °            0+: string "0+"            xx: String of decimal value of multiple(or single) IR output channels. E.g., 63(0x3F) means use 6 output channels simultaneously(ch1+ch2+ch3+ch4+ch5+ch6).            .: leading character '.'            yyy: String of IR cmd no., e.g. "001", "224".</p> <p><b>[Response]</b>            &gt;: response character '&gt;'</p>
#AA0+xx.000 #AA0+xxx.00 #AA0+xxx.000	>	<p><b>[Request]</b>            #: leading character '#'            AA: Module ID (hexadecimal) = Modbus Net ID °            n: string of decimal value of single IR output ch., n='1'~'6'            +: character '+'            xx / xxx: string representing decimal value of IR cmd no.                ^range of "xx": "01"~"99";                ^range of "xxx": "001"~"224";            .00 / .000: string ".00" or ".000"</p> <p><b>[Response]</b>            &gt;: response character '&gt;'</p>

**Note:** Firmware version ≥ v1.80 supports these commands.

### Example:

1. IR-210, Modbus Net ID = 27 (0x1B), IR command number = 12, and IR output channel = 1 and 6 [100001(binary)=>33(decimal)].

DCON Command: **#1B0+32.012**

2. IR-210, Modbus Net ID = 10 (0x0A), IR command number = 8, and IR output channel = 2.

DCON Command:

- (1) **#0A2+08.000**
- (2) **#0A2+008.00**
- (3) **#0A2+008.000**



---

## 7. Technical support

Please contact us if you have any questions about products.

ICP DAS website: <http://www.icpdas.com>

Email: [service@icpdas.com](mailto:service@icpdas.com)