

# S...type Check Valve



## S...type

Sizes 6, 8, 10, 15, 20, 25, 30  
Max. Working Pressure: 315 bar  
Max. Flow: 450 L/min

### Contents

Function and configuration	02
Specification	02
Technical data	03
Characteristic curves	03
Unit dimensions of threaded connection	04
Unit dimensions of sub-plate mounting	05

### Features

- Poppet valve seat
- Threaded connection and sub-plate mounting
- Various cracking pressures, optional

### Symbol

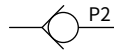

P1

## Function and configuration

S type check valve is used to allow fluid flowing in one direction and leakage-free closure in the opposite direction. When fluid flow via port P1, fluid pushes poppet (2) to move overcoming the spring(3), and connects chamber P1 and P2. When fluid flows from P2 to P1, poppet (2) moves left and the check valve closes.

For check valves without a spring, the fixed position should ensure that the poppet will remain at the closed position.

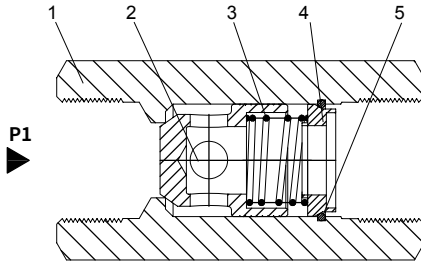

1. Housing
2. Poppet spool
3. Spring
4. Spring seat
5. Steel wire retaining ring

## Specification

Check valve

Nominal sizes	Threaded connection	Sub-plate mounting
6	=6	
8	=8	
10	=10	=10
15	=15	
20	=20	=20
25	=25	
30	=30	=30

For threaded connection = A  
For sub-plate mounting = P

S J / \*

Further details in clear text

Only for sub-plate mounting  
No code = NBR seals  
V = FKM seals

Only for threaded connection  
1= G thread  
2= Metric thread

·0J= Threaded connection revision index  
-2XJ= Sub-plate mounting series 20J to 29J  
(20J to 29J: unchanged installation and connection dimensions)

0 = Without spring  
1 = Crack pressure 0.5 bar  
2 = Crack pressure 1.5bar  
3 = Crack pressure 3bar  
5 = Crack pressure 5bar

## Technical data

Size		6	8	10	15	20	25	30
Max. flow-rate	L/min	15	30	40	120	200	300	400
Max. operating pressure	bar	315, 210 (NPTF1 1/4, NPTF1 1/2)						
Crack pressure	bar	0.5; 1.5; 2; 3; 4; 5						
Fluid		Mineral oil ; Phosphate ester						
Fluid temperature range	°C	-30 to +80						
Viscosity range	mm <sup>2</sup> /s	2.8 to 500						
Degree of contamination		Maximum permissible degree of fluid contamination: Class 9. NAS 1638 or 20/18/15, ISO4406						

01

## Characteristic curves (Measured at t=40°C ±5°C, using HLP46)

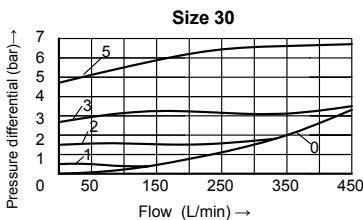
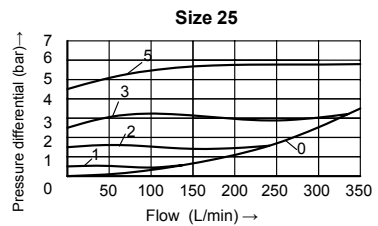
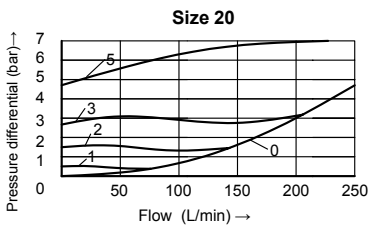
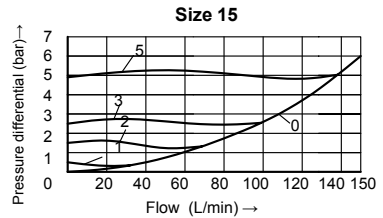
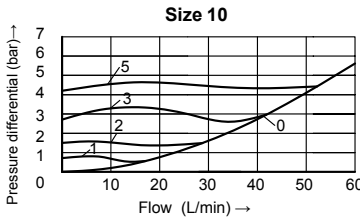
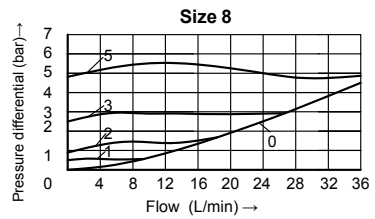
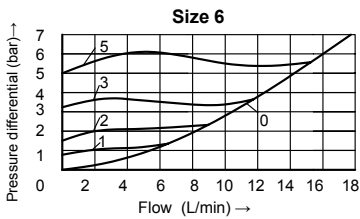

## Unit dimensions of threaded connection

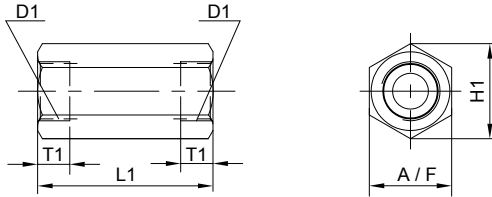

Size	6	8	10	15	20	25	30	
D1	G	G 1/4	G 3/8	G 1/2	G 3/4	G 1	G1 1/4	G1 1/2
	Metric	M14×1.5	M18×1.5	M22×1.5	M27×2	M33×2	M42×2	M48×2
	NPTF	NPTF 1/4	NPTF 3/8	NPTF 1/2	—	—	NPTF 1 1/4	NPTF 1 1/2
	SAE	6SAE (9/16-18)	8SAE (3/4-16)	10SAE (7/8-14)	12SAE (1 1/16-12)	16SAE (1 5/16-12)	20SAE (1 5/8-12)	24SAE (1 7/8-12)
H1	22(SAE=28)	28(SAE=34.5)	34.5	41.5	53	69	75	
L1	58(SAE=68)	58(SAE=70)	72(SAE=85)	85(SAE=98)	98(SAE=108)	120 (SAE=130)	132(SAE=142)	
T1	12(SAE=14)	12(SAE=17)	14(SAE=20)	16(SAE=22)	18(SAE=22)	20 (SAE=22)	22(SAE=24)	
A/F	19(SAE=24)	24(SAE=30)	30	36	46	60	65	
Weight(kg)	0.1(SAE=0.23)	0.2(SAE=0.29)	0.3(SAE=0.35)	0.5(SAE=0.58)	1(SAE=1.1)	2(SAE=2.2)	2.5(SAE=2.7)	

# Unit dimensions of sub-plate mounting

01

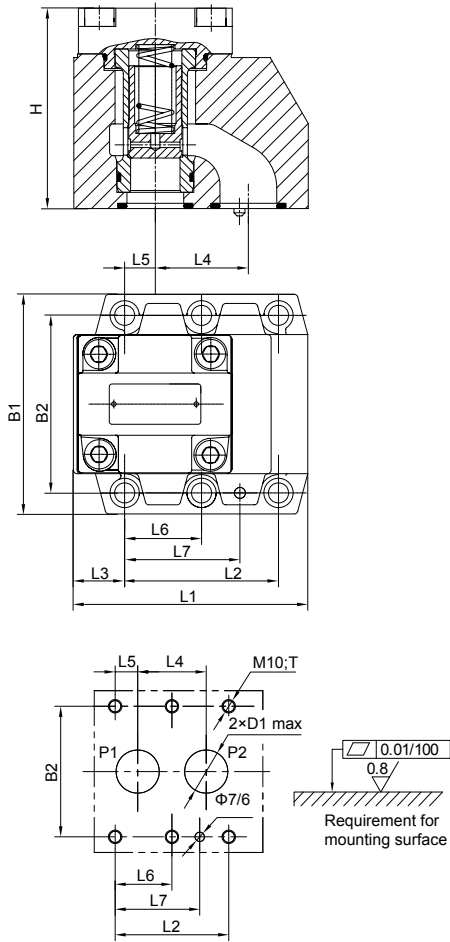

Size	B1	B2	L1	L2	L3	L4	L5	L6	L7	H	D1	T	O-ring	Weight(Kg)
10	85	66.7	78	42.9	18	28.6	7.2	-	31.8	71	$\Phi 13$	23	17.12×2.62	2
20	102	79.4	101	60.3	23	38.1	11.1	-	44.5	108	$\Phi 22$	24	28.17×3.53	4.3
30	120	96.8	128	84.2	28	50.8	16.7	42.1	62.7	110	$\Phi 30$	25	34.52×3.53	7.7