



07060201-0787-001
Date 2025-03-21
CN 安装说明
EN Instruction Sheet

1. 安全注意事项 (Safety precautions)

本说明书涉及产品为工业产品，并且均为开放型外壳设计。要求用户使用产品时，务必将产品安装于具有防尘、防潮以及免于电击 / 冲击等意外的控制柜内，并且需要设置保护措施以防止非维护人员不当操作或意外导致设备故障或损坏，造成不可避免的人员危险和财产损失。

The products in this manual are industrial products and are all open-type housing designs. It is essential to install these products within a control cabinet that is safeguarded against dust, moisture, and accidents such as electric shocks or physical impacts. Additionally, protective measures must be taken to prevent malfunctions or damage caused by improper operation or accidents involving non-maintenance personnel. Failure to do so may lead to serious risks to personnel safety and potential loss of property.

更详细的信息请参考 E630 系列变频器简要说明书。

Please refer to the E630 series variable frequency drive (VFD) manual for more detailed information.

2. 命名规则 (Model identification)

HDv E630 - 4T 7.5 B S - * **

1	产品名称 (Product name)	4	功率等级 (Power class)	5	制动组件 (Braking component)
HDv	禾川 (Hechuan Technology)	0.7	750W	空(N/A)	不含制动单元 (Without brake unit)
		1.5	1.5KW	B	含制动单元 (With brake unit)
2	产品系列 (Product series)	2.2	2.2KW	6	功能组件 (Function component)
E630	E630	3.7	3.7KW	空(N/A)	不含STO功能 (Without STO function)
		5.5	5.5KW	S	含STO功能 (With STO function)
3	产品电压等级 (Product voltage class)	7.5	7.5KW	7	固件代号 (Firmware code)
2S	单相 (Single phase) 220V-240V	011	11KW		
2T	三相 (Three-phase) 220V-240V	8	软件代号 (Software code)
4T	三相 (Three-phase) 380V-480V	400	400KW		
		450	450KW		

3. 通用电气及环境规格 (General electrical and environmental specifications)

3.1 通用电气规格 (General electrical specifications)

型号 (Model)	电源容量 (Power capacity) kVA	输入电流 (Input current) A	输出电流 (Output current) A	适配电机 (Compatible motor)		型号 (Model)	电源容量 (Power capacity) kVA	输入电流 (Input current) A	输出电流 (Output current) A	适配电机 (Compatible motor)	
				kW	HP					kW	HP
单相电源 (Single-Phase power supply) : 200~240V, 50/60Hz						三相电源 (Three-Phase power supply) : 380~480V, 50/60Hz					
HDv-E630-2S0.7*	1.5	8.2	4.0	0.75	1	HDv-E630-4T0.7*	1.5	3.4	2.1	0.75	1
HDv-E630-2S1.5*	3.0	14.0	7.0	1.5	2	HDv-E630-4T1.5*	3.0	5.0	3.8	1.5	2
HDv-E630-2S2.2*	4.0	23.0	9.6	2.2	3	HDv-E630-4T2.2*	4.0	5.8	5.1	2.2	3
三相电源 (Three-Phase power supply) : 200~240V, 50/60Hz						HDv-E630-4T3.7*	5.9	10.5	9.0	3.7	5
HDv-E630-2T0.7*	2.1	4.6	3.8	0.75	1	HDv-E630-4T5.5*	8.9	14.6	13.0	5.5	7.5
HDv-E630-2T1.5*	4.1	6.3	7.2	1.5	2	HDv-E630-4T7.5*	11.0	20.5	17.0	7.5	10
HDv-E630-2T2.2*	5.2	9.0	9	2.2	3	HDv-E630-4T11	17.0	26.0	25.0	11.0	15
HDv-E630-2T3.7*	7.6	11.4	13	3.7	5	HDv-E630-4T15	21.0	35.0	32.0	15.0	20
HDv-E630-2T5.5*	14.7	32.3	25	5.5	7.5	HDv-E630-4T18.5	24.0	38.5	37.0	18.5	25
HDv-E630-2T7.5*	18.9	41.3	32	7.5	10	HDv-E630-4T22	30.0	46.5	45.0	22	30
HDv-E630-2T11*	27	59	45	11	15	HDv-E630-4T30	40.0	62.0	60.0	30	40
HDv-E630-2T15*	28.1	57	60	15	20	HDv-E630-4T37	57.0	76.0	75.0	37	50
HDv-E630-2T18.5*	31.6	69	75	18.5	25	HDv-E630-4T45	69.0	92.0	91.0	45	60
HDv-E630-2T22*	40.7	89	91	22	30	HDv-E630-4T55	85.0	113.0	112.0	55	70
HDv-E630-2T30*	48.5	106	112	30	40	HDv-E630-4T75	114.0	157.0	150.0	75	100
HDv-E630-2T37*	63.6	139	150	37	50	HDv-E630-4T90	134.0	180.0	176.0	90	125
HDv-E630-2T45*	75	164	176	45	60	HDv-E630-4T110	160.0	214.0	210.0	110	150
HDv-E630-2T55*	89.6	196	210	55	70	HDv-E630-4T132*	192.0	256.0	253.0	132	200
HDv-E630-2T75*	131	287	304	75	100	HDv-E630-4T160*	231.0	307.0	304.0	160	250
HDv-E630-2T9*	167	365	377	90	125	HDv-E630-4T200*	250.0	385.0	377.0	200	300
						HDv-E630-4T220*	280.0	430.0	426.0	220	350
						HDv-E630-4T250*	355.0	468.0	465.0	250	400
						HDv-E630-4T280*	396.0	525.0	520.0	280	450
						HDv-E630-4T315*	445.0	590.0	585.0	315.0	500
						HDv-E630-4T355*	500.0	665.0	650.0	355.0	-
						HDv-E630-4T400*	565.0	785.0	725.0	400.0	600
						HDv-E630-4T450*	630.0	883.0	820.0	450.0	-

*注: 产品研发中

*Note: The product is under research and development.

3.2 环境规格 (Environmental requirements)			
项目	Item	规格	Specifications
海拔高度	Altitude	≤1000m (1000~3000m降额使用)	Altitude ≤ 1000m (Derating is required for altitude from 1000m to 3000m)
使用环境	Operating environment	控制柜内安装, 开放式及室内使用	Installation within a control cabinet, open-type and indoor use
工作温度	Operating temperature	-10~50°C (40~50°C降额使用)	-10~50°C (Derating is required for temperature from 40 to 50°C)
储存温度	Storage temperature	-40~70°C	-40~70°C
环境湿度	Ambient humidity	20~95%RH (无结露)	20~95%RH (non-condensing)
振动耐受	Vibration resistance	<5.9m/s ² (0.6g)	<5.9m/s ² (0.6g)
污染等级	Pollution degree	污染度2	Level 2
冷却方式	Cooling method	自然冷却	Natural air cooling
防护等级	IP rating	IP20	IP20

*注: 若设备未依制造商指定方式使用, 设备所提供的保护可能会被减弱。

*Note: If the equipment is used in a manner not specified by the manufacturer, the protection provided by the equipment may be impaired.

4. 安装说明 (Installation instructions)

4.1 控制柜安装 (Installation within a control cabinet)

CN 请保证安装方向与墙壁垂直, 使用自然对流或风扇对设备进行冷却, 通过螺钉固定安装在控制柜。请参考右侧示意图, 在设备周围留有足够的空间。并排安装时, 建议横向两侧预留 50mm 以上间距。

EN Please install the product perpendicular to the wall and ensure a sufficient cooling effect via natural air or a cooling fan. Fix and install it in the control cabinet with screws. Please leave enough clearance around the product as shown in the right figure. During a side-by-side installation, please leave a horizontal clearance of more than 50 mm on both sides.

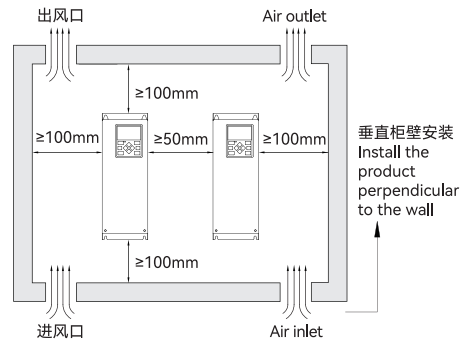

4.2 整机拆装 (VFD mounting and dismounting)

CN 安装时, 使用两颗内六角组合螺丝紧固设备, 先预锁螺丝②, 然后将设备底部基板卡入螺丝②内, 再去用螺丝①紧固上部壳体, 建议扭矩 3.5N.m。
拆卸时, 请确保设备断电, 使用螺丝刀将②号内六角组合螺丝预松, 后用螺丝刀拆卸螺丝①, 同时用手扶住设备壳体, 防止掉落, 拆掉螺丝①, 然后上提设备即可拆卸。

EN During mounting, use two socket head cap combination screws to fasten the equipment. First, pre-tighten screw ②, then insert the bottom base plate of the equipment into screw ②. Then, use screw ① to fasten the upper part of the housing, with a recommended torque of 3.5 N.m.

EN During dismounting, ensure the equipment is powered off. Use a screwdriver to pre-loosen the socket head cap combination screw No. ②. Then, use a screwdriver to remove screw ① while supporting the equipment housing by hand to prevent it from dropping. After removing screw ①, lift the equipment upwards to complete the dismounting.

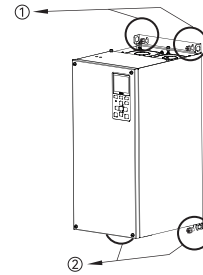

4.3 功能 I/O 接口 线缆拆装 1 (Functional I/O interface, cable connecting and disconnecting 1)

CN 使用螺丝刀将对应接口螺丝拧松或将对应该压块按下, 随后将线缆插入到螺丝下方或压块对应接线孔中, 最后拧紧螺丝或松开压块, 即可完成线缆拆装。
使用螺丝刀将对应接口螺丝拧松或将对应该压块压下, 随后将线缆从接线孔中取出即可完成拆卸。

EN During connection, use a screwdriver to loosen the screw of the corresponding interface or press down the corresponding unlocking tab. Then, insert the cable under the screw or into the corresponding wiring hole of the unlocking tab. Finally, tighten the screw or release the unlocking tab, and the cable installation is completed.

EN During disconnection, use a screwdriver to loosen the screw of the corresponding interface or press down the corresponding unlocking tab. Then, pull out the cable from the wiring hole to complete the disconnection.

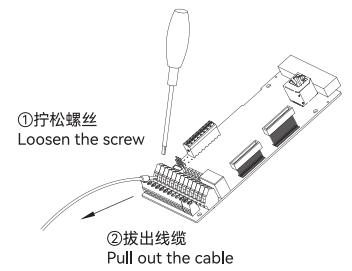
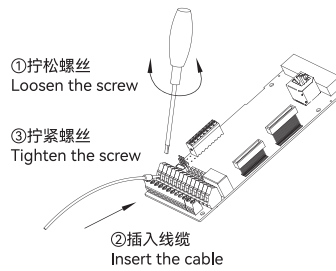

4.4 功能 I/O 接口 线缆拆装 2 (Functional I/O interface, cable connecting and disconnecting 2)

CN 参考 4.3 步骤。

EN Refer to the steps in 4.3.

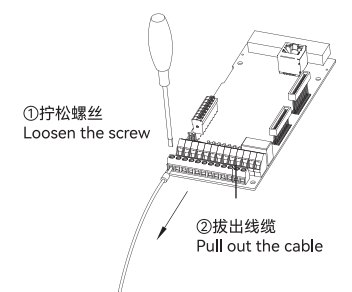
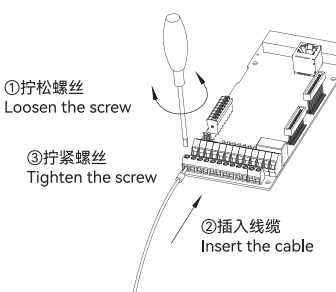

4.5 功能 I/O 接口 线缆拆装 3 (Functional I/O interface, cable connecting and disconnecting 3)

CN 参考 4.3 步骤。

EN Refer to the steps in 4.3.

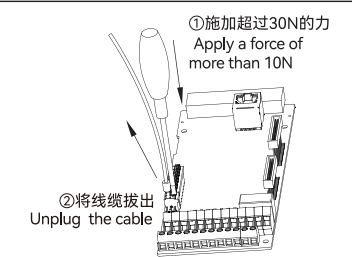
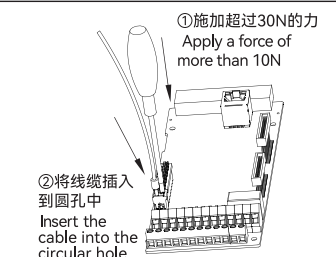

4.6 主回路接口 线缆拆装 4 (Main circuit interface, cable connecting and disconnecting 4)

CN 确保设备断电，使用螺丝刀将螺丝拧松，将接线端子插入螺丝垫片底部，最后拧紧螺丝，即可完成线缆安装。
使用螺丝刀将对应接口螺丝拧松，随后将线缆从接线孔中取出即可完成拆卸。

EN Before cable connection, ensure that the equipment is powered off. During connection, use a screwdriver to loosen the screw, insert the terminal into the bottom of the screw washer, and finally tighten the screw to complete the cable connection.
During disconnection, use a screwdriver to loosen the screw of the corresponding interface, and then pull out the cable from the wiring hole to complete the disconnection.

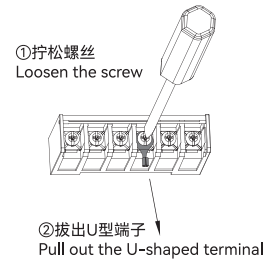
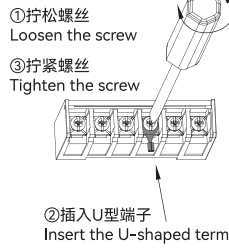

5. 接口和尺寸说明 (Interface and dimension description)

功率 (Power) 11~15kW

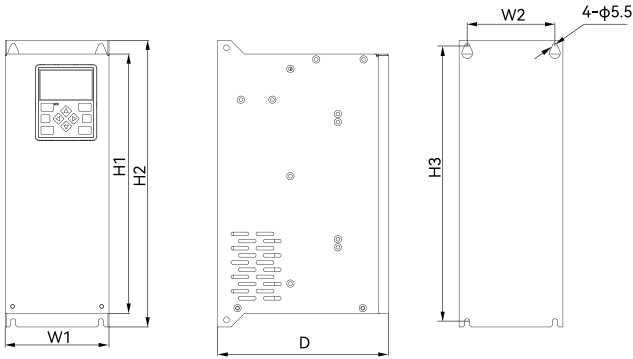

外形尺寸 (Dimension) : mm					
W1	W2	H1	H2	H3	D
116	98	290	320	307.5	191

功率 (Power) 18.5~30kW

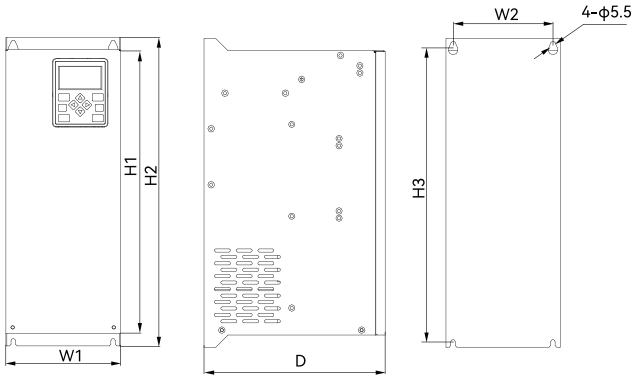

外形尺寸 (Dimension) : mm					
W1	W2	H1	H2	H3	D
142	124	353	383	370.5	225

功率 (Power) 37~45kW

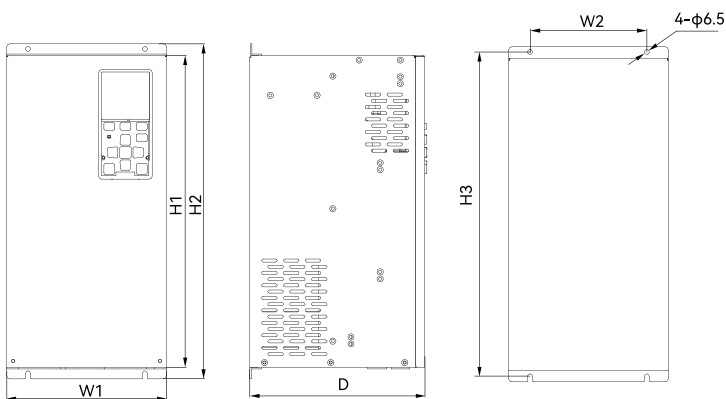

外形尺寸 (Dimension) : mm					
W1	W2	H1	H2	H3	D
205	150	400	430	416.5	224.5

功率 (Power) 55~75kW

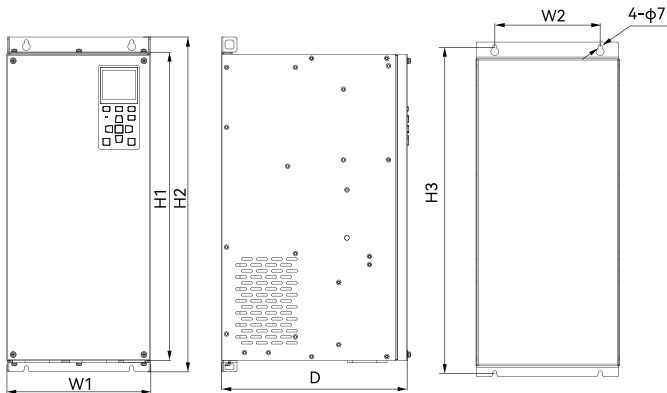

外形尺寸 (Dimension) : mm					
W1	W2	H1	H2	H3	D
240	176	511	558.5	544	310

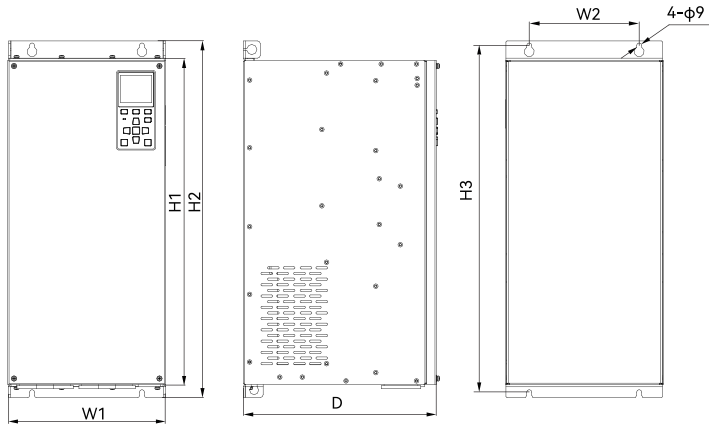

外形尺寸 (Dimension) : mm					
W1	W2	H1	H2	H3	D
280	195	575	632.5	615	342

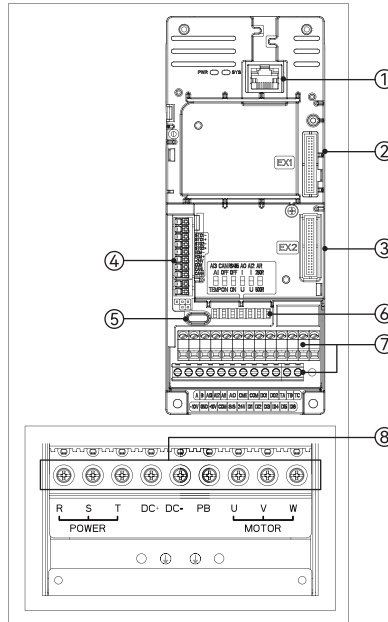

序号(No.)	名称	Name	功能	Function
1	RJ45接口	RJ45 interface	外引键盘接口	External keyboard interface
2	EX1	EX1	功能扩展卡接口	Functional expansion card interface
3	EX2	EX2	编码器PG卡接口	Encoder PG card interface
4	STO/CAN	STO/CAN	安全扭矩关断/CANopen接口	STO/CANopen interface
5	USB接口	USB interface	USB接口, 仅用于烧录程序, 无法用于连接电脑后台软件	Only used for program burning, unable to connect to the computer background software
6	功能拨码开关	Functional DIP switch	配置不同功能的拨码开关, 具体说明请参考注1	Used for configuring different functions. For specific instructions, please refer to Note 1
7	功能I/O接口	Functional I/O interface	数字量I/O 模拟量I/O 继电器, 公共端等多种功能接口, 具体说明请参考第七节: 功能I/O接口说明	Multiple functional interfaces include digital I/Os, analog I/Os, relays, common terminals. For specific instructions, please refer to Section 7: Functional I/O interface description
8	主回路接口	Main circuit interface	电源输入, 电机动力输出接口	Power supply input and motor power output interfaces

注 1: 拨码开关功能说明

Note 1: DIP switch function description

拨码丝印 (DIP switch silk-screen printing)	AI3	CAN	RS485	AO	AI2	AR
拨上 (Toggle up)	AI (模拟量输入) (Analog input)	OFF (终端电阻断开) (Terminal resistance disconnected)	OFF (终端电阻断开) (Terminal resistance disconnected)	I (输出电流信号) (Output current signal)	I (输入电流信号) (Input current signal)	250R (AI2输入阻抗) (AI2 input impedance)
拨下 (Toggle down)	TEMP (温度输入) (Temperature input)	ON (终端电阻接入) (Terminal resistance connected)	ON (终端电阻接入) (Terminal resistance connected)	U (输出电压信号) (Output voltage signal)	U (输入电压信号) (Input voltage signal)	500R (AI2输入阻抗) (AI2 input impedance)

注: 不同型号接口外观不一致, 此表格仅描述接口功能

Note: Interface appearances differ by model. This table only describes interface functions.

6. 指示灯和面板说明 (Indicator and LED panel description)

丝印 (Screen printing)	指示灯含义 (Indicator meaning)	颜色 (Color)	状态	Status	说明	Description
RUN	电源指示灯 (Power supply indicator)	红色 (Red)	熄灭	Not lit	母线掉电	Bus in powered-off state
			常亮	Lit	母线上电	Bus in powered-up state
	故障指示灯 (Fault indicator)	红色 (Red)	熄灭	Not lit	变频器无故障	No inverter fault
			常亮	Lit	变频器故障	Inverter fault
	运行指示灯 (Operation indicator)	绿色 (Green)	熄灭	Not lit	变频器未正常运行	Inverter not running normally
			常亮	Lit	变频器运行	Inverter running
	蓝牙指示灯 (Bluetooth indicator)	绿色 (Green)	熄灭	Not lit	蓝牙未连接	Bluetooth not connected
			常亮	Lit	蓝牙已连接	Bluetooth connected
	无线连接指示灯 (Wireless connection indicator)	绿色 (Green)	熄灭	Not lit	无线未连接	Wireless not connected
			常亮	Lit	无线已连接	Wireless connected
REV	反转指示 (Reverse rotation indicator)	绿色 (Green)	熄灭	Not lit	由反转到正转	From reverse rotation to forward rotation
			常亮	Lit	停机前反转指令 运行状态时, 变频器反转运行	Reverse rotation command before shutdown During operation, the inverter runs in reverse rotation
FWD	正转指示 (Forward rotation indicator)	绿色 (Green)	熄灭	Not lit	由正转到反转	From forward rotation to reverse rotation
			常亮	Lit	停机前正转指令 运行状态时, 变频器正转运行	Forward rotation command before shutdown During operation, the inverter runs in forward rotation
A	电流指示 (Current indicator)	绿色 (Green)	熄灭	Not lit	-	-
V	电压指示 (Voltage indicator)	绿色 (Green)	熄灭	Not lit	-	-
			常亮	Lit	当前单位为电压	Current unit is voltage
Hz	频率指示 (Frequency indicator)	绿色 (Green)	熄灭	Not lit	-	-
			常亮	Lit	当前单位为频率	Current unit is frequency
%	百分比指示 (Percentage indicator)	绿色 (Green)	熄灭	Not lit	-	-
			常亮	Lit	当前单位为百分比	Current unit is percentage
°C	摄氏度指示 (Celsius indicator)	绿色 (Green)	熄灭	Not lit	-	-
			常亮	Lit	当前单位为摄氏度	Current unit is Celsius
kWh	功率指示 (Power indicator)	绿色 (Green)	熄灭	Not lit	-	-
			常亮	Lit	当前单位为 kWh	Current unit is kWh
rpm	转速指示 (Rotational speed indicator)	绿色 (Green)	熄灭	Not lit	-	-
			常亮	Lit	当前单位为转 / 分	Current unit is rpm

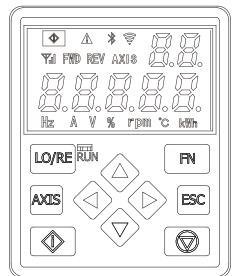
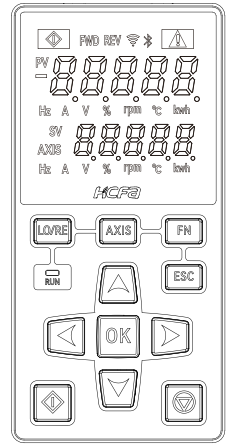

按键符号(key)	名称	Name	详细说明	Description
	运行按键	Run	面板控制情况方式下, 用于控制电机运行操作	Used for controlling motor operation under panel control mode
	控制命令来源切换按键	Control command source switching	操作面板与远程切换	Used for switching between operation panel and remote control
	RESET/STOP 按键	RESET/STOP	故障报警时, 用于复位故障; 运行状态下, 停止电机运行	Used for resetting faults during fault alarms and stopping the motor during operation
	参数设置 / 确认	Parameter setting/confirmation	确认, 进入下一级菜单	Used for confirming and entering the next-level menu
	FN	FN	多功能按键, 由 P10.02 确定	Multi-functional key, determined by P10.02
	AXIS	AXIS	保留	Reserved
	左移位按键	Left shift	在 0 级菜单更换显示参数, 在 2 级和 3 级菜单下, 向左移动循环显示面板参数	Used for changing the display parameters in the 0-level menu and moving left to cyclically display the panel parameters in the 2nd and 3rd level menus
	UP 按键	UP	增大显示参数	Used for increasing the display parameters
	Down 按键	Down	减小显示参数	Used for decreasing the display parameters
	右移位按键	Right shift	在 0 级菜单更换显示参数, 在 2 级和 3 级菜单下, 向右移动循环显示面板参数	Used for changing the display parameters in the 0-level menu and moving right to cyclically display the panel parameters in the 2nd and 3rd level menus
	ESC	ESC	进入 0 级菜单或返回上一级菜单	Used for entering the 0-level menu or returning to the previous-level menu

7. 端子及配线说明 (Terminal and wiring description)

主回路接口说明 (Main circuit interface description)												
11~30kW				37~45kW				55~110kW				
引脚 (Pin)	R	S	T	DC+		DC-	PB	U	V	W	⏚	
说明 (Description)	三相主电源输入 (Three-phase main circuit powersupply input)			母线电压正极/制动电阻接口 (Positive polarity of the busbar voltage / Braking resistor interface)		母线电压负极 (Negative polarity of the busbar voltage)	制动电阻接口 (Braking resistor interface)	电动机动力输出接口 (Motor power output interface)			电机接地端子 (Motor grounding terminal)	

功能I/O接口说明 (Functional I/O interface description)												
A	B	AI3	AI2	AI1	AO	CME	COM	DO1	DO2	TA	TB	TC

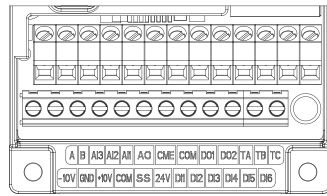

-10V	GND	+10V	COM	SS	24V	DI1	DI2	DI3	DI4	DI5	DI6	-
------	-----	------	-----	----	-----	-----	-----	-----	-----	-----	-----	---

类型 (Type)	引脚 (Pin)	说明 (Description)	类型 (Type)	引脚 (Pin)	说明 (Description)
电源 (Power supply)	+10V / GND	+10V电源 (+10V Power supply)	数字量输出 (Digital output)	DO1 / CME	数字量输出1 (Digital output 1)
	-10V / GND	-10V电源 (-10V Power supply)		DO2 / COM	数字量输出2 (Digital output 2)
	24V / COM	内部电源DC24V (Internal power supply DC24V)	继电器输出 (Relay output)	TA / TB	继电器常开输出 (Relay normally open output)
	SS	数字量输入DI公共端 (Digital input DI common terminal)		TA / TC	继电器常闭输出 (Relay normally closed output)
		CME	数字量输出DO公共端 (Digital output DO common terminal)	模拟量输出 (Analog output)	AO / GND
模拟量输入 (Analog input)	AI1 / GND	模拟量输入1 (Analog input 1)	RS485通讯接口 (RS485 communication interface)	A	RS485通讯信号A (RS485 communication signal A)
	AI2 / GND	模拟量输入2 (Analog input 2)		B	RS485通讯信号B (RS485 communication signal B)
	AI3 / GND	模拟量输入3 (Analog input 3)			
数字量输入 (Digital input)	DI1	数字量输入1 (Digital input 1)			
	DI1/SS	数字量输入2 (Digital input 2)			
	DI3	数字量输入3 (Digital input 3)			
	DI4	数字量输入4 (Digital input 4)			
	DI5	数字量输入5 (Digital input 5)			
	DI6	数字量输入6 (Digital input 6)			

IO接线 (IO wiring)

类型 (Type)	数字量输入接线 (Digital input wiring)		高速输入接线 (High-speed input wiring)	
	内部电源接线 (Internal power supply wiring)	外部电源接线 (External power supply wiring)	内部电源接线 (Internal power supply wiring)	外部电源接线 (External power supply wiring)
漏型输入 (NPN Input)				
源型输入 (PNP Input)				

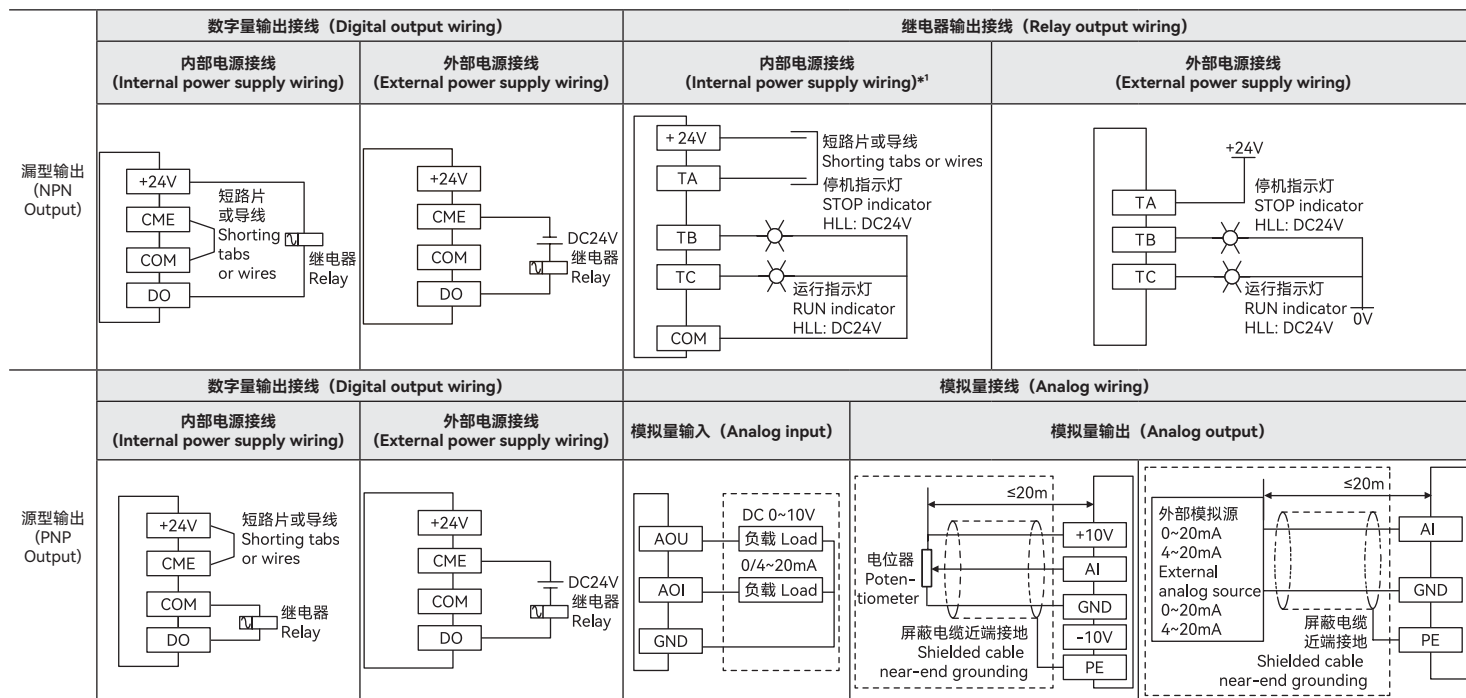

*注 1: 此处以 DI/DO/AI 示意, 端子可以是 DI1~DI5, HDI1, DO1, DO2, AI1~AI2。

Note 1: Here it is indicated by DI/DO/AI. The terminals can be DI1~DI5, HDI1, DO1, DO2, AI1~AI2.

三相 380V 机种变频器标准接线 (Standard wiring for three-phase 380V VFD model)

