

iSN-101 / iSN-104

Liquid Leak Detection Module

User Manual



iSN-101



iSN-101/DIN



iSN-104

Version: 2.0.0

Date: FEB. 2022

Edited by Jerry Tseng

Warranty

All products manufactured by ICP DAS are warranted against defective materials for a period of one year from the date of delivery to the original purchaser.

Warning

ICP DAS assumes no liability for damages consequent to the use of this product.

ICP DAS reserves the right to change this manual at any time without notice. The information furnished by ICP DAS is believed to be accurate and reliable. However, no responsibility is assumed by ICP DAS for its use, not for any infringements of patents or other rights of third parties resulting from its use.

Copyright

Copyright © 2021 by ICP DAS. All rights are reserved.

Contact Us

If you have any questions, please feel free to contact us via email at:

Service@icpdas.com

Contents

1. Introduction.....	4
2. Hardware.....	7
2.1 Specifications.....	7
2.2 Appearance & Settings.....	8
iSN-101 Appearance.....	8
iSN-104 Appearance.....	10
2.3 Connector for Power/ RS-485 / Liquid Leak Detection Cable / Relay Output.....	11
2.4 Pin Assignments.....	14
2.5 Wire Connections.....	15
2.6 Application.....	16
2.7 Dimensions (unit: mm).....	18
3. Configuration via RS-485.....	19
Appendix A: DCON Command Sets.....	26
A-1. iSN-101/104 DCON Command Sets.....	26
Appendix B: ModbusMasterToolPC.....	31
Appendix C: Modbus Address Table.....	35
C-1. iSN-101/104 Modbus Address Mappings (Base 1).....	35
Revision History.....	38

1. Introduction

The iSN-101/104 Liquid Leak Detection Module is a low-cost intelligent liquid leak detection device that iSN-101 can be used to directly control Relay Output. No additional conversion module is needed and the iSN-101/104 can be easily integrated with a variety of monitoring systems to achieve remote alarm and remote device control. The iSN-101/104 Liquid Leak Detection module can be used to monitor double-core leader cable lengths of up to 500 meters, and can be used with both the Liquid Leak Detection Cable and its included Leakage Probe. If liquid is detected, the controller immediately activates the output relay - the normally open, normally closed passive output signal. The module can be easily integrated with other collection hosts connected to the network. The iSN-101/104 is suitable for real-time leak detection in critical locations, such as computer room base stations, warehouses, libraries, museums and industrial sites, and also for air handling equipment, refrigeration units, liquid containers, or pump tanks, etc., where there is a need to monitor any leakage of the equipment.

When required, communication with the iSN-101/104 can be programmed based on the Modbus RTU protocol, with the added benefit that different addresses can be configured via hardware to allow for Modbus RTU communication.

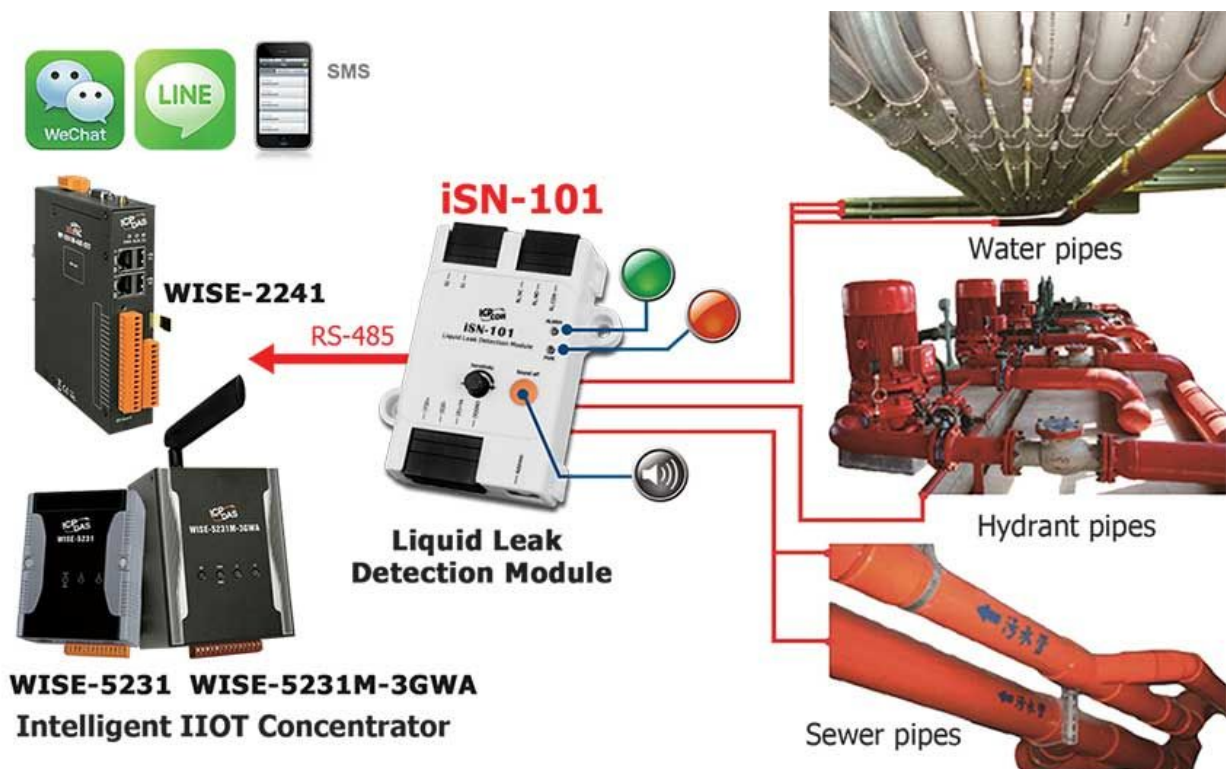

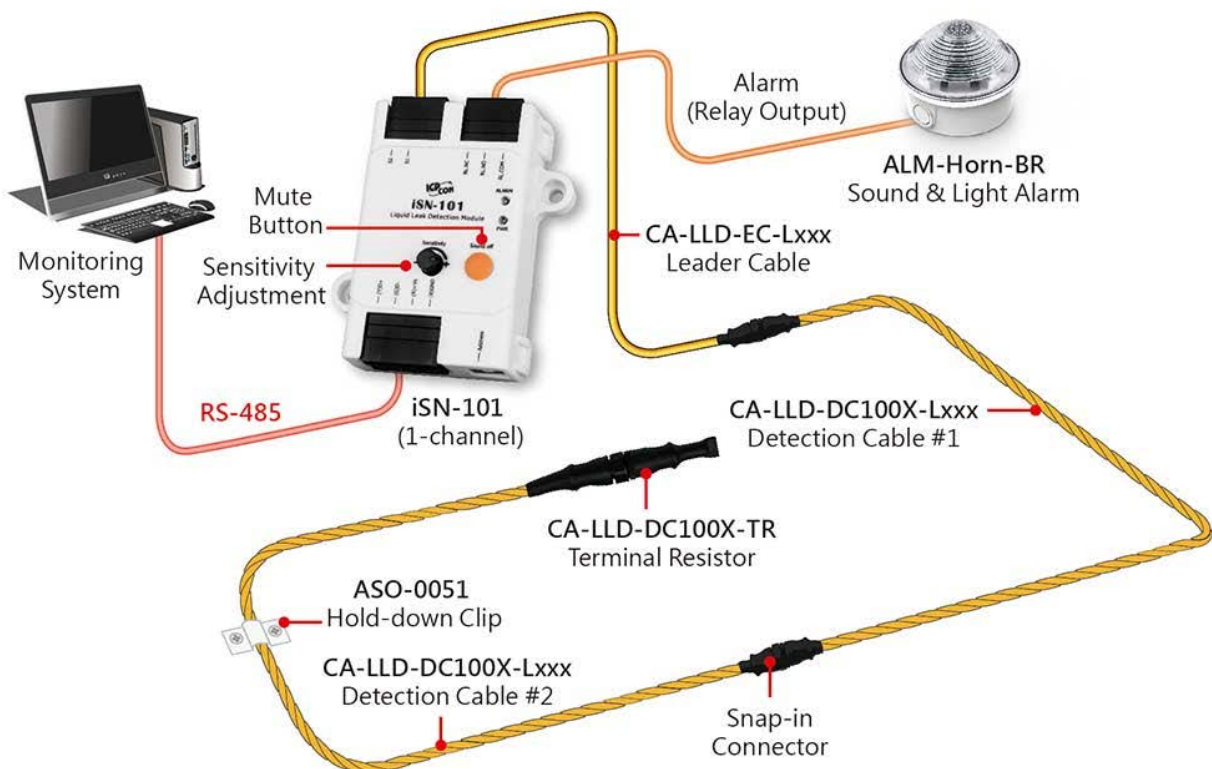
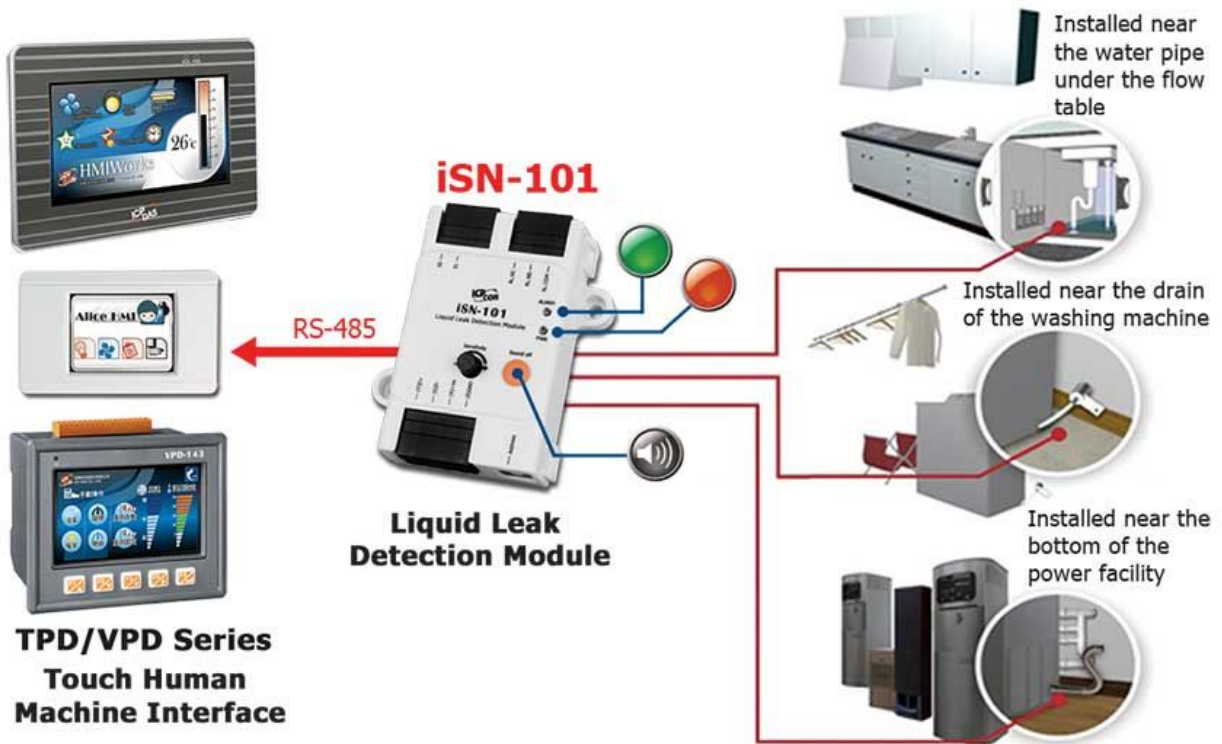

Features

- ▶ **Leak detection triggers and audible alarm**
- ▶ **Open wire detection triggers and audible alarm**
(iSN-101 Only for after 2021,Q1(FW:A1.3 or later) and used with CA-LLD-DC100X-Lxxx + CA-LLD-DC100X-TR to have Open wire detection.)
- ▶ **A mute button to silence the alarm**
- ▶ **Two LED indicators to display the status of the power and the alarm**
(iSN-104 have Five LED)
- ▶ **A configurable Output Relay (only iSN-101)**
- ▶ **Leader cables and Liquid Leak Detection Cable can be up to 500 meters.**
- ▶ **Adjustable detection sensitivity**
- ▶ **Supports the DCON and the Modbus RTU Protocols**
- ▶ **Embedded Dual Watchdog**
- ▶ **Wide Operating Temperature Range: -25 to +75°C**
- ▶ **Tiny Form Factor with Easy Screw Mounting**

2. Hardware

2.1 Specifications

Model	iSN-101	iSN-104
Analog Input		
Channels	1	4
Wiring Cables Length	500 meters(include Liquid Leak Detection Cable)	
Adjustment of the Detection Sensitivity	26K Ω ~580K Ω	
Communication		
Interface	RS-485	
Data Format	N,8,1 / O,8,1 / E,8,1 / N,8,2	
Baud Rate	Software Configuration: 1200 ~ 115200 bps	
Protocol	Modbus RTU or DCON	
Node Addresses	96 ~ 127 for hardware configuration 0 ~ 255 for software configuration	
LED Indicators		
Power	1 as Power Indicator(Green LED)	1 as Power Indicator (Red LED)
Alarm	1 as Alarm Indicator (Red LED)	4 as Alarm Indicator (Red LED)
Audible alarm		
Audible alarm	70 dB Audible alarm with silence button(switch)	
Relay Output		
Form C Relay	0.5 A @ 125 VAC 2 A @ 30 VDC	- -
EMS Protection		
ESD (IEC 61000-4-2)	\pm 8 kV Air for Random Point	
EFT (IEC 61000-4-4)	\pm 4 kV for Power	
Power Requirements		
Reverse Polarity Protection	Yes	
Input Voltage Range	+10 ~ +30 VDC	
Consumption	1.5 W Max.	1.6 W Max.
Mechanical		
Dimensions (L x W x H)	83 mm x 70 mm x 29 mm	72 mm x 95 mm x 57mm
Installation	Screw Mounting or DIN-Rail	DIN-Rail

Environment	
Operating Temperature	0 ~ +50°C
Storage Temperature	-30 ~ +75°C
Humidity	10 ~ 90% RH, Non-condensing

2.2 Appearance & Settings

iSN-101 Appearance

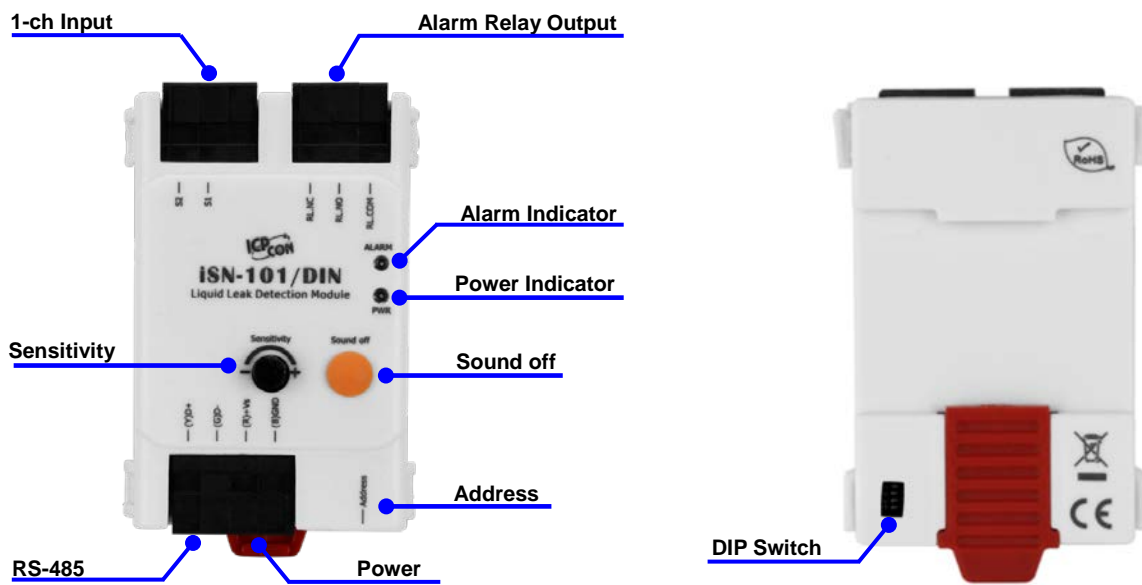

LED Indicators

The two LED indicators from up to down are:

- ▶ Alarm: red for leak alarm condition.

blinking red for open wire alarm condition.

*(iSN-101 Only for after 2021,Q1(FW:A1.3 or later) and used with

CA-LLD-DC100X-Lxxx + CA-LLD-DC100X-TR to have Open wire detection.)

- ▶ PWR: green for normal operation.

Sound off Button

The button is used to stop the audible alarm.

Audible alarm

70 dB Audible alarm with silence button

Sensitivity Adjustment



Sensitivity Adjustment Range: 26KΩ ~ 580KΩ

- **1-ch Input**

Insert Leader Cable. As cable termination is not polarity conscious

DIP Switch

DIP Switch Description			
	SW1	ON	DCON Protocol
		OFF	Modbus RTU Protocol
	SW2	ON	Software Configuration
		OFF	Hardware Configuration
	SW3	ON	High Node Address
		OFF	Low Node Address
	SW4	ON	INIT Mode
		OFF	Normal Mode

Address

Address Settings via Hardware Configuration

		0 ~ F for Addresses 96 ~ 111 (Low Node Address)
		0 ~ F for Addresses 112 ~ 127 (High Node Address)

Relay Output

Wire Connection:

Output Type	ON State Readback as 1	OFF State Readback as 0
Relay Output		

iSN-104 Appearance

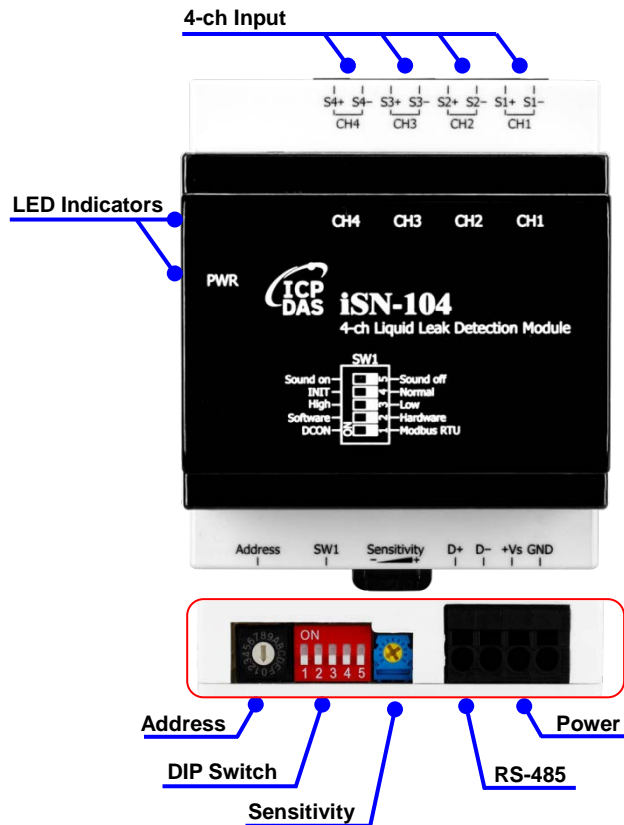

LED Indicators

The five LED indicators:

- ▶ Alarm: LED light leak alarm condition.
LED blinking for open wire alarm condition.
- ▶ PWR: Power LED.

Audible alarm

70 dB Audible alarm with silence button

Sensitivity Adjustment

Sensitivity Adjustment Range: 26KΩ ~ 580KΩ



4-ch Input

Insert Leader Cable. As cable termination is not polarity conscious

DIP Switch

DIP Switch Description			
	SW1	ON	DCON Protocol
		OFF	Modbus RTU Protocol
	SW2	ON	Software Configuration
		OFF	Hardware Configuration
	SW3	ON	High Node Address
		OFF	Low Node Address
	SW4	ON	INIT Mode
		OFF	Normal Mode
	SW5	ON	Sound On
		OFF	Sound Off

Address

Address Settings via Hardware Configuration

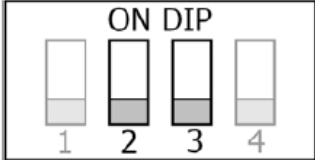
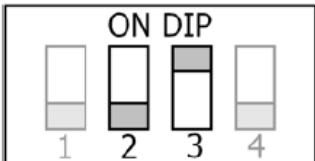
		0 ~ F for Addresses 96 ~ 111 (Low Node Address)
		0 ~ F for Addresses 112 ~ 127 (High Node Address)

2.3 Connector for Power/ RS-485 / Liquid Leak Detection Cable / Relay

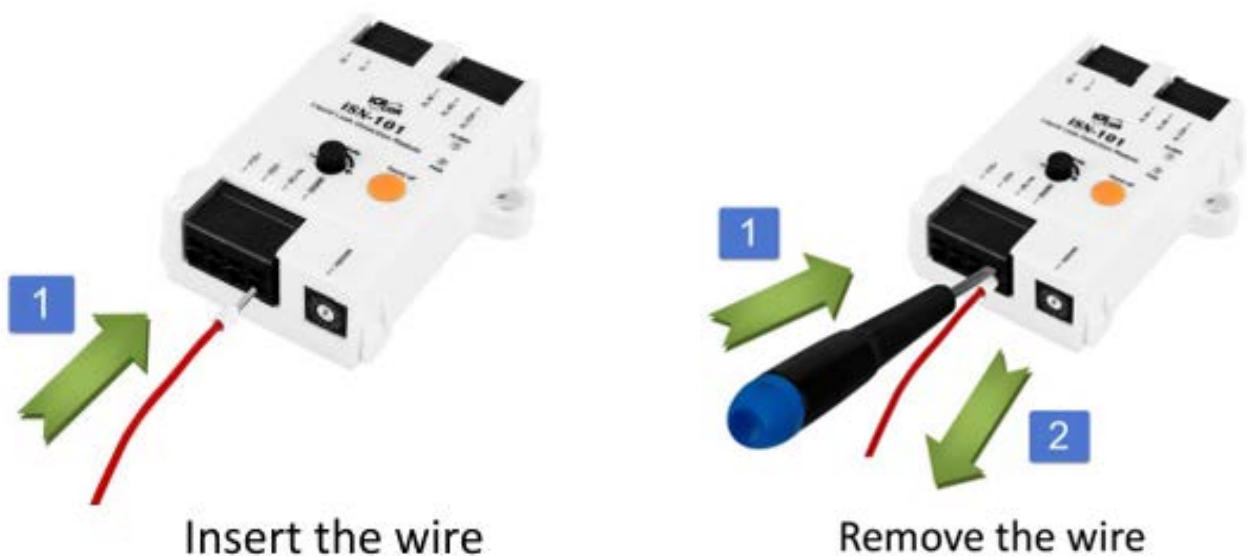

Connect the Leader Plug to Liquid Leak Detection Plug



CA-LLD-DC100-Lxxx



CA-LLD-DC100X-Lxxx



CA-LLD-EC-L030



CA-LLD-DC100X-TR



CA-LLD-DP100



ASO-0051



ASO-0052

CA-LLD-DC100-Lxxx	Liquids Leak Detection Cable, w/o Position and cannot be connected in series
CA-LLD-DC100X-Lxxx	Liquids Leak Detection Cable, w/o Position and can be connected in series
CA-LLD-EC-L030	The leader cable can be extended with a shielded twiced pair cable, AWG 18~14. The total cable length that includes leader cable and Liquid Leak Detection Cables is 500 m max.
CA-LLD-DC100X-TR	Terminal Resistor, for CA-LLLD-DC100X-Lxxx
CA-LLD-DP100	Leakage Probe
ASO-0051	180 Hold-Down Clip (include 50 pcs)
ASO-0052	90 Hold-Down Clip (include 50 pcs)

The fool-proofing groove (as red circle) is useful for easy connection of Liquid Leak Detection Plug and Leader Plug. Please make sure they are located in the same direction when connecting these two items.

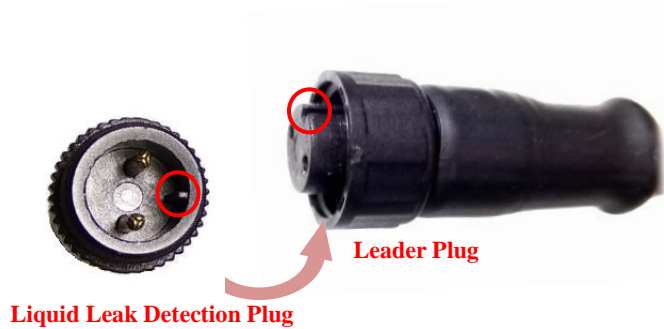

Make sure to tighten firmly



Connect the Leakage Probe with Wires



Take off cover

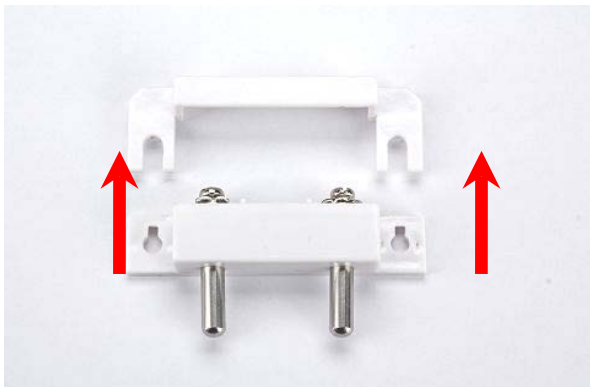

Put wire and tighten the screw down

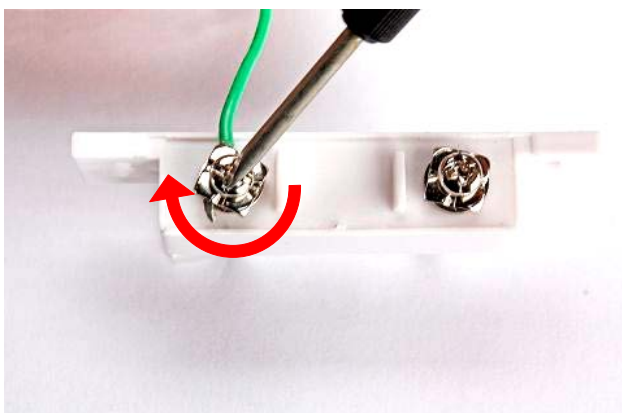
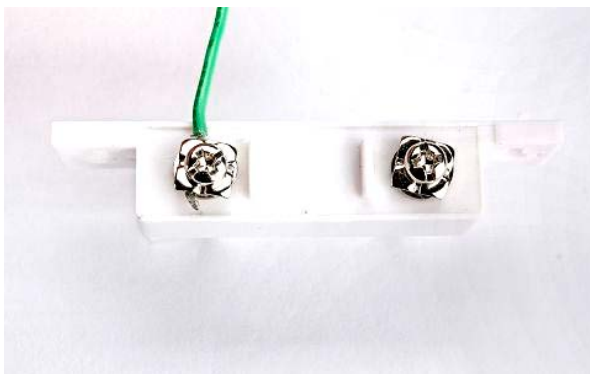

Put cover back

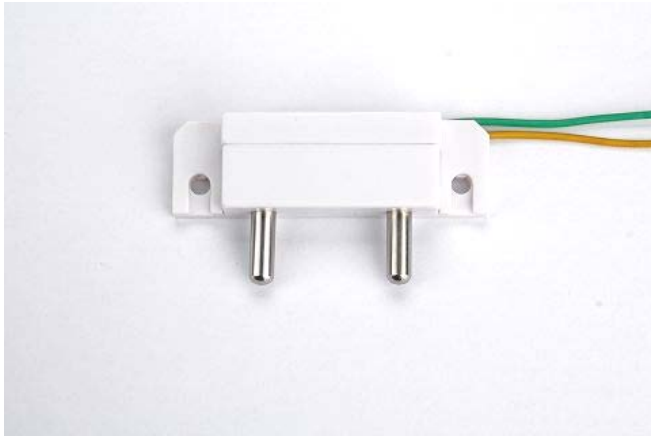

Install the two mounting screws into the 2 keyhole mounting holes.

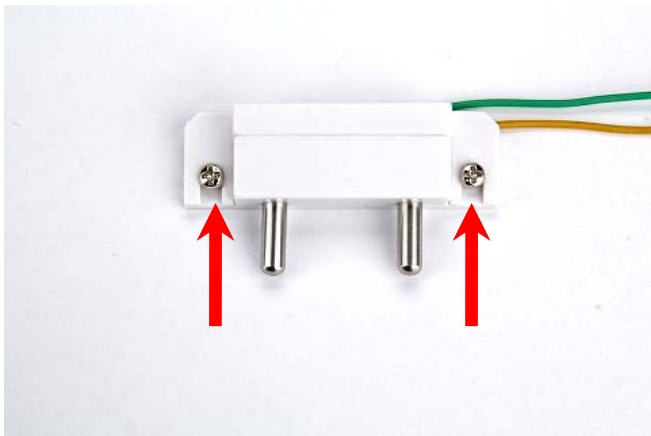

2.4 Pin Assignments

iSN-101

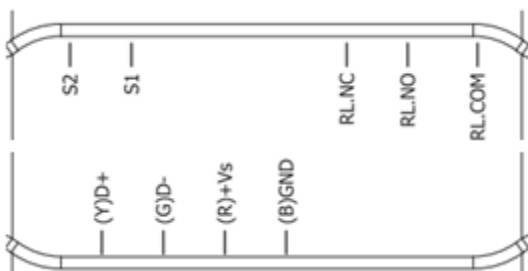

iSN-104



2.5 Wire Connections

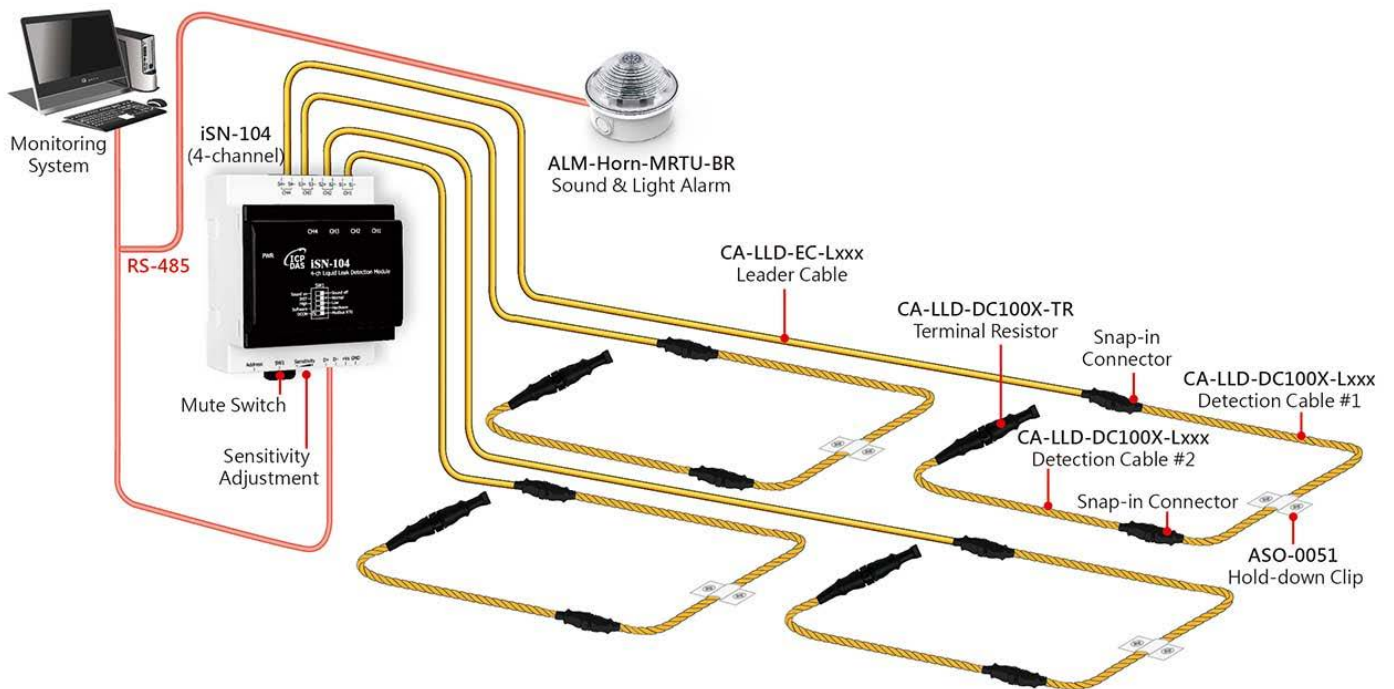
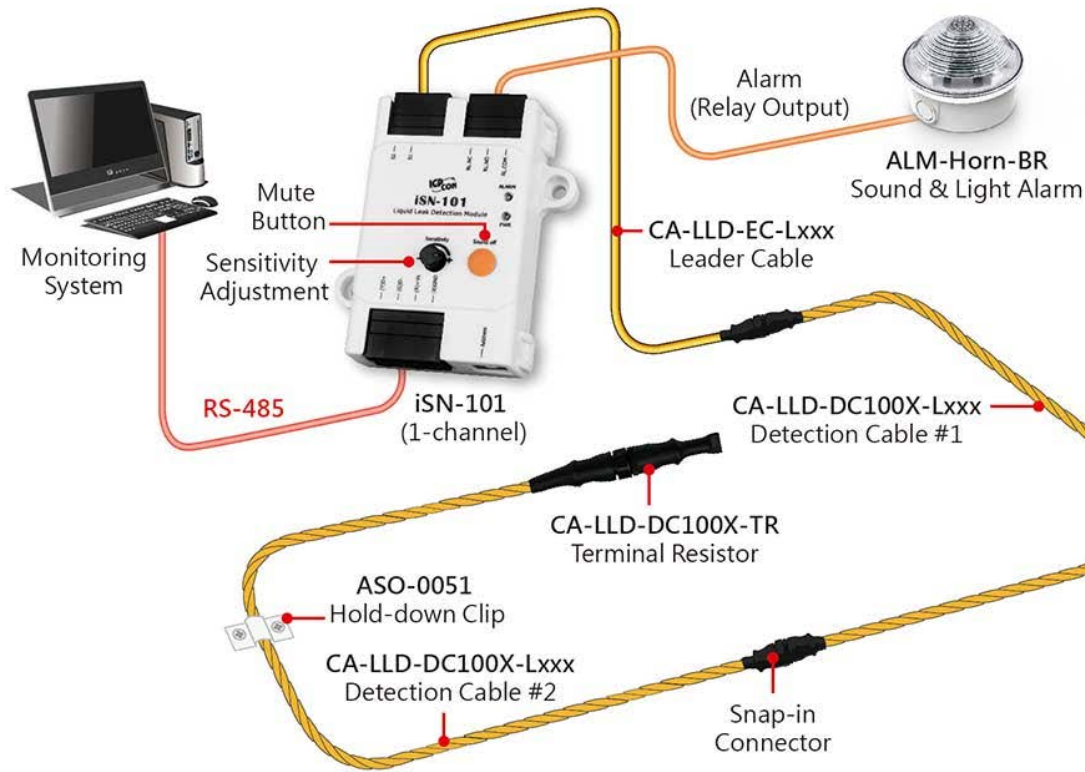

Extended Cable : We suggest to use twisted pair cable AWG18-14 with shielded, sectional area from 0.75 ~ 2.0mm².. The Leader Cable can be increased in length with an extended cable, up to 500 meters including the Liquid leak Cable.

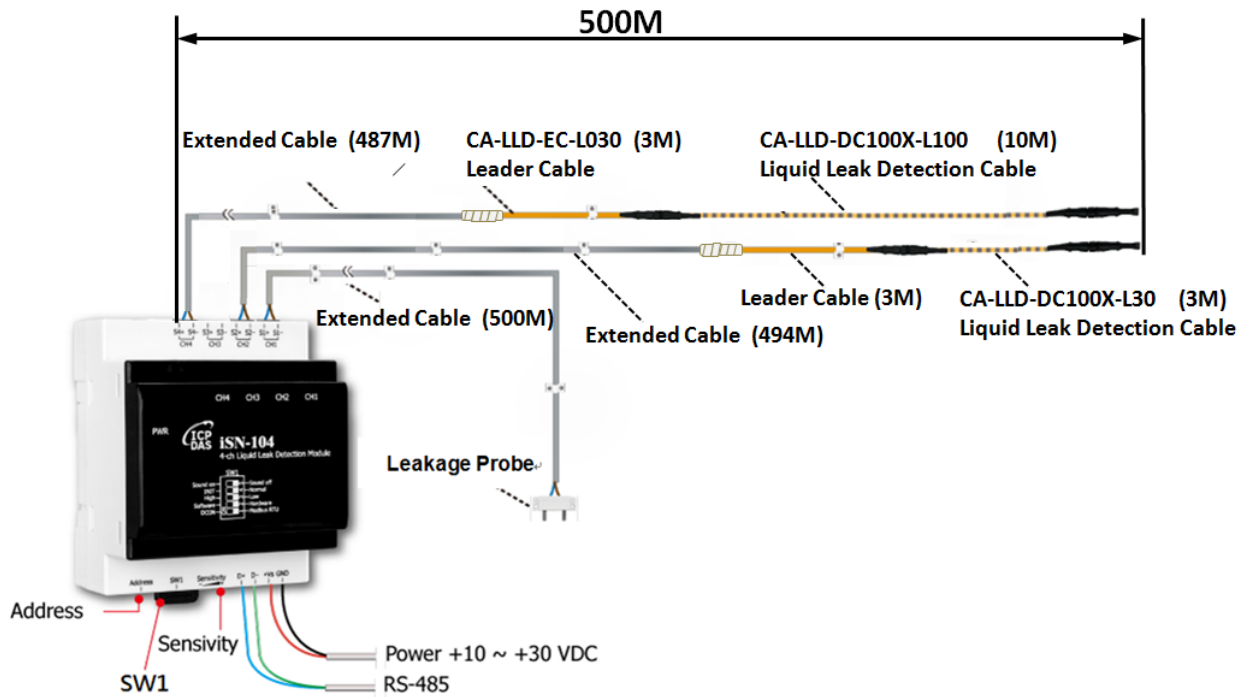

2.6 Application

Liquid Leak Detection Cable

Liquid Leak Detection Cable is designed to detect leaks over a wider area, and the path of the leak is not easily predetermined. The Liquid Leak Detection Cable is ideal for open areas. The Liquid Leak Detection Cable can even be fixed directly to the water supply and return lines. Liquid Leak Detection Cable is suitable for larger surface areas with multiple leak points.

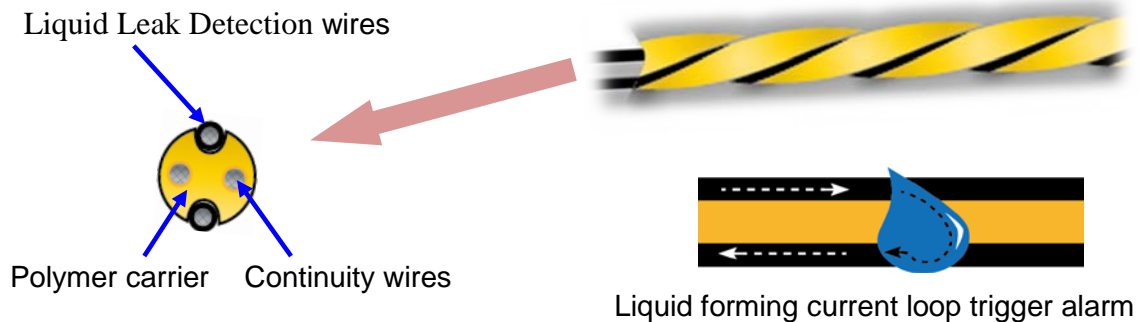

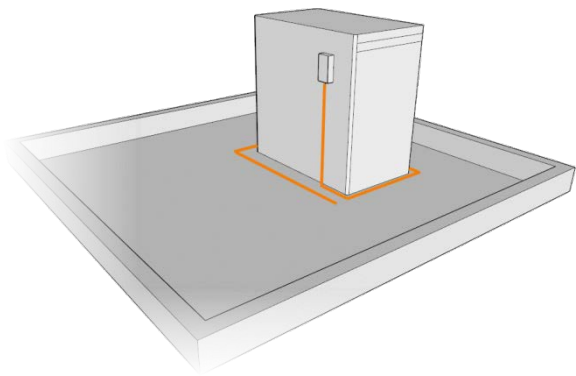
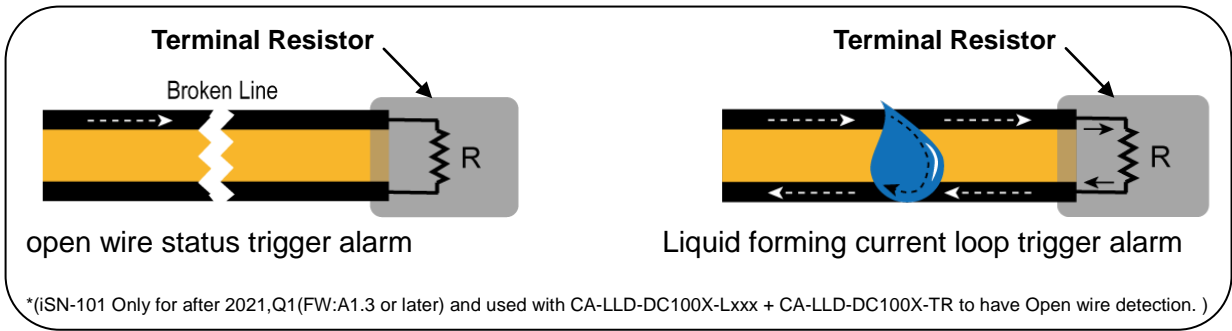

Server Room Floor

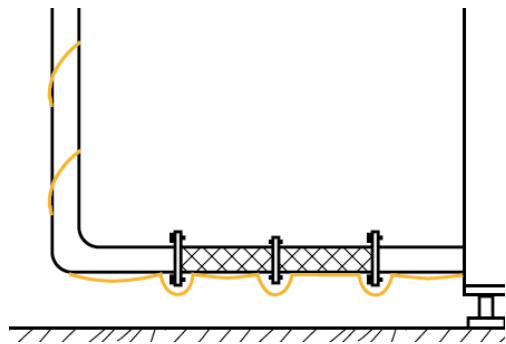

Water supply

Leakage Probe

Leakage Probe are designed to detect leaks at specific locations and specific water levels.

The base of the Leakage Probe has two probes. To detect a leak, the water must touch both probes at the same time, thus completing a circuit and triggering an alarm. Leakage Probe are ideal for drains, Water storage tank , containers and other restricted areas.

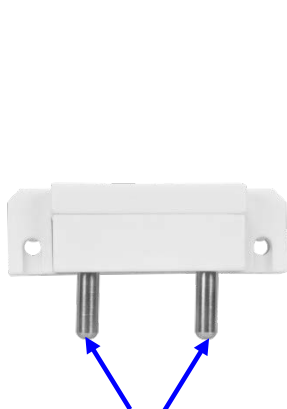

Stainless steel probes

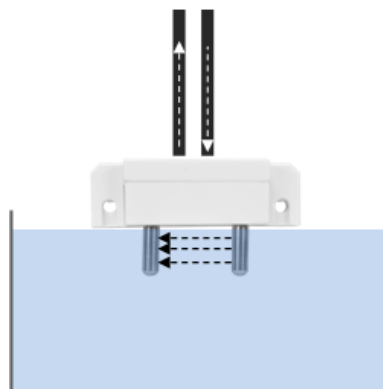

Liquid forming current loop trigger alarm

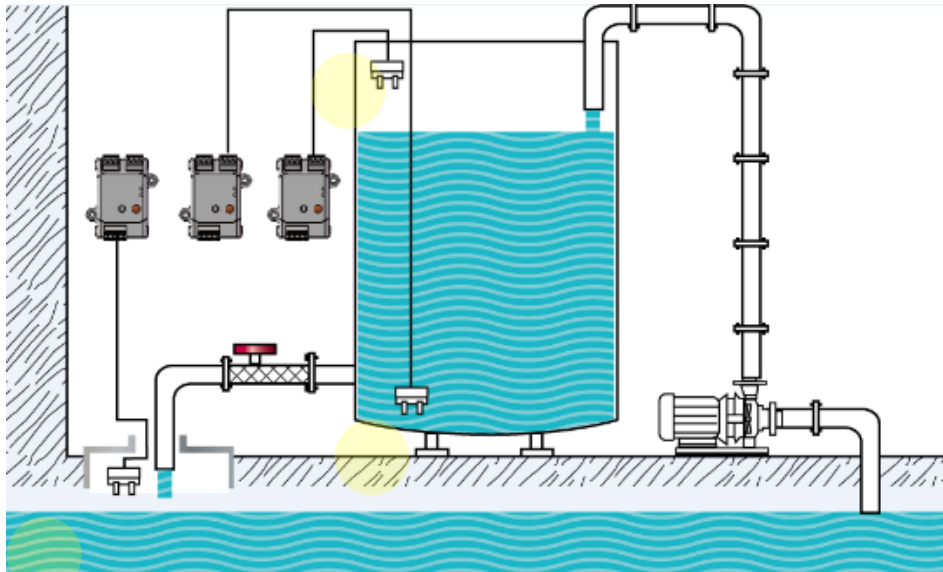

iSN-101/104 senses various water levels through the Leakage Probe

2.7 Dimensions (unit: mm)

iSN-101

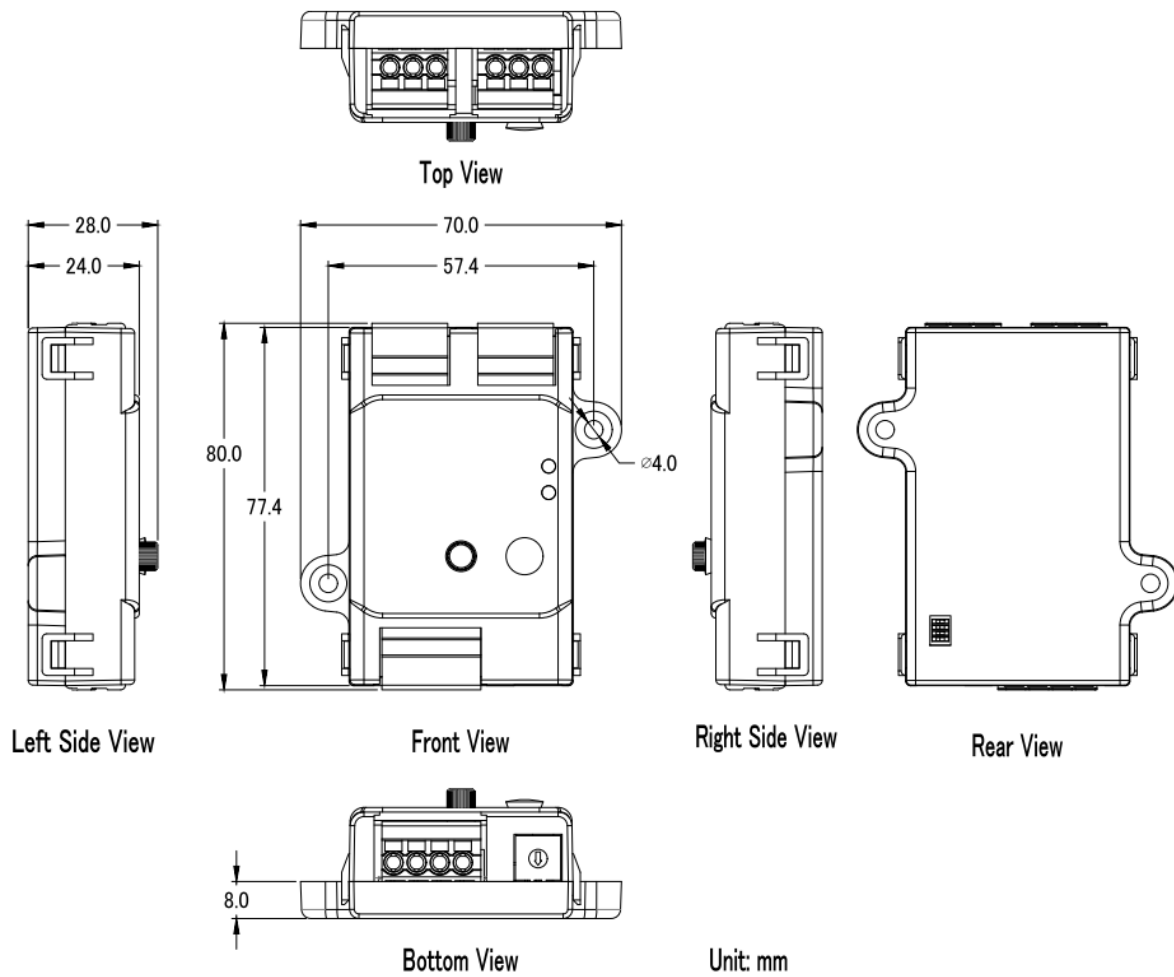

iSN-104

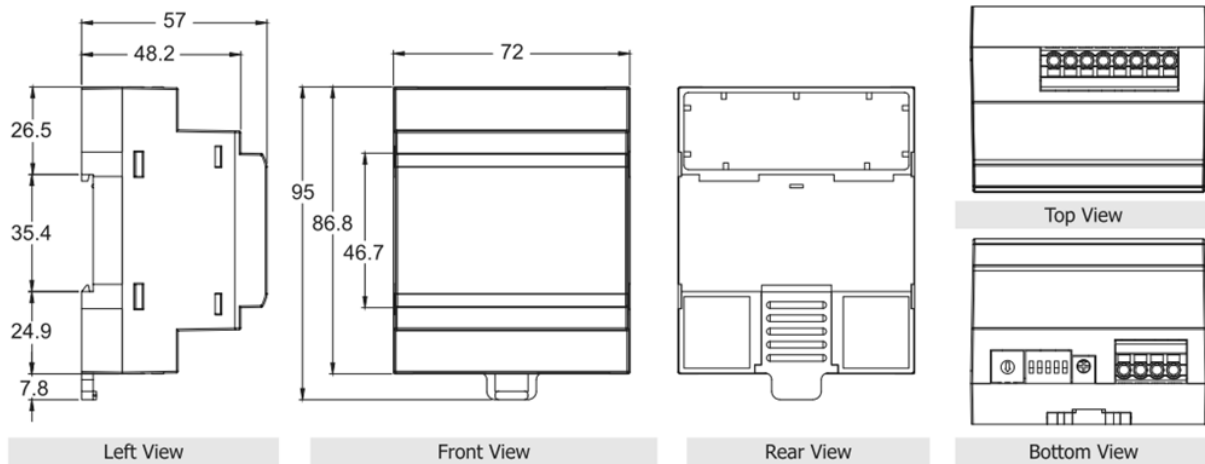

3. Configuration via RS-485

- The factory default settings for RS-485 communication
 - Address: 1
 - Protocol: Modbus/RTU
 - Baudrate: 9600
 - Parity: N,8,1
 - Response Delay (ms): 0

Note

If there are multiple iSN-101/104 connected to the same RS-485 network, each module needs to be set with a unique RS-485 address. More than one module having the same address will cause communication failure

- Testing RS-485 Communication
 1. Download the DCON Utility Pro from https://www.icpdas.com/en/product/guide+Software+Utility_Driver+DCON_Utility_Pro

2. Launch the DCON_UTILITY_Pro.exe.

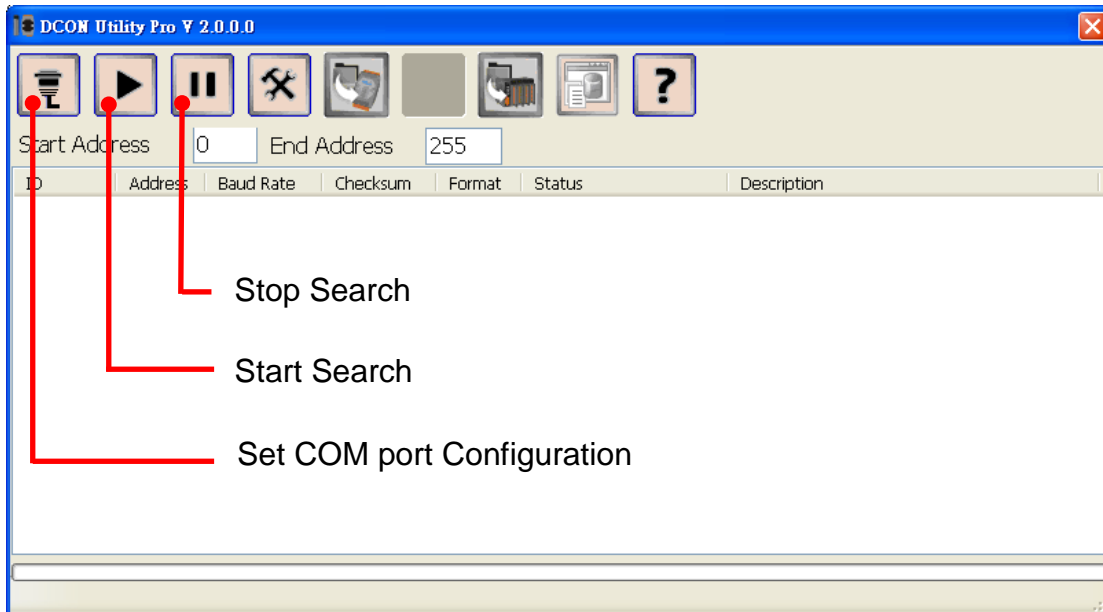

3. Click the icon  to configure the COM port.

4. Select the COM Port number used to connect the iSN-101/104 logger.

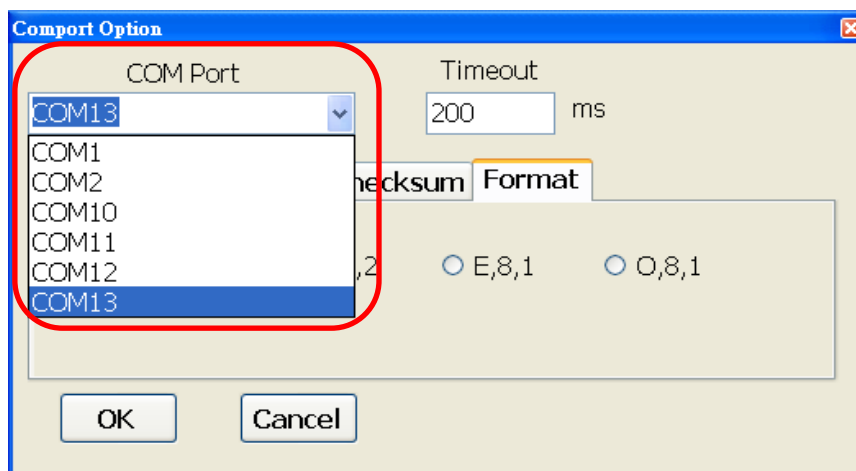

5. The Baud Rate is factory default to 9600 bps.

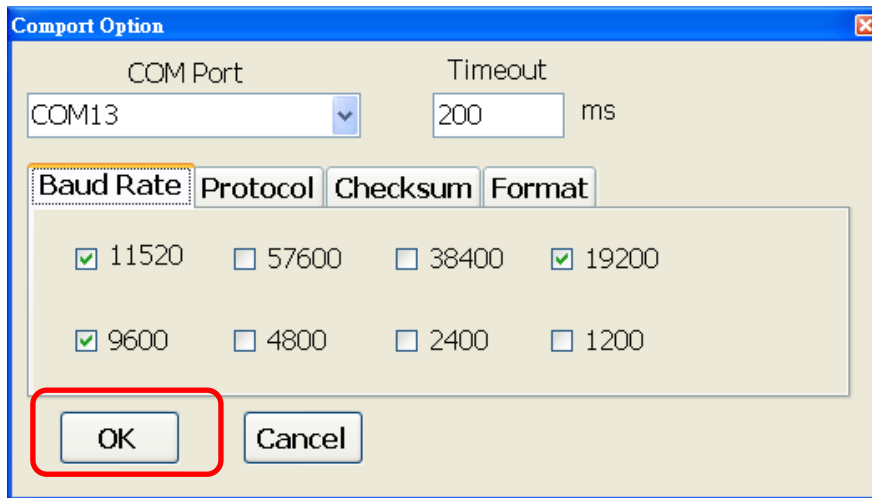

6. Select the Protocol tab.

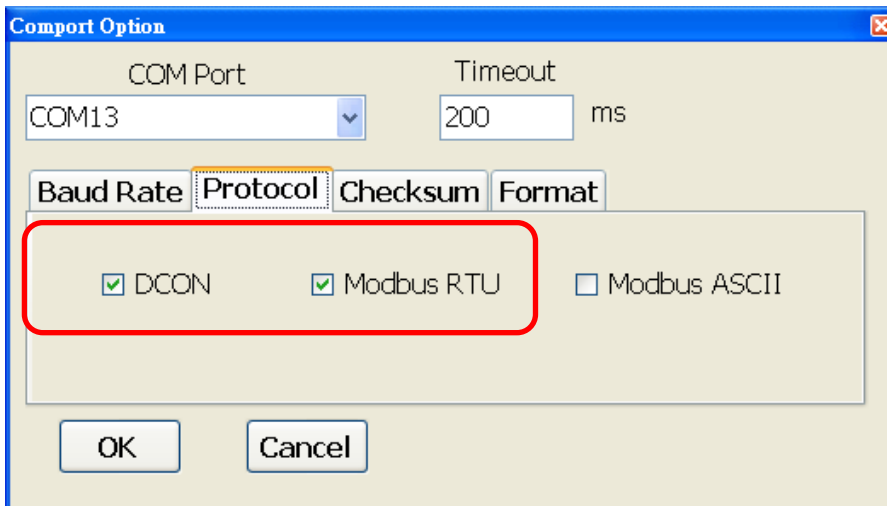

7. Select the Format tab and check the parity that set in the logger.

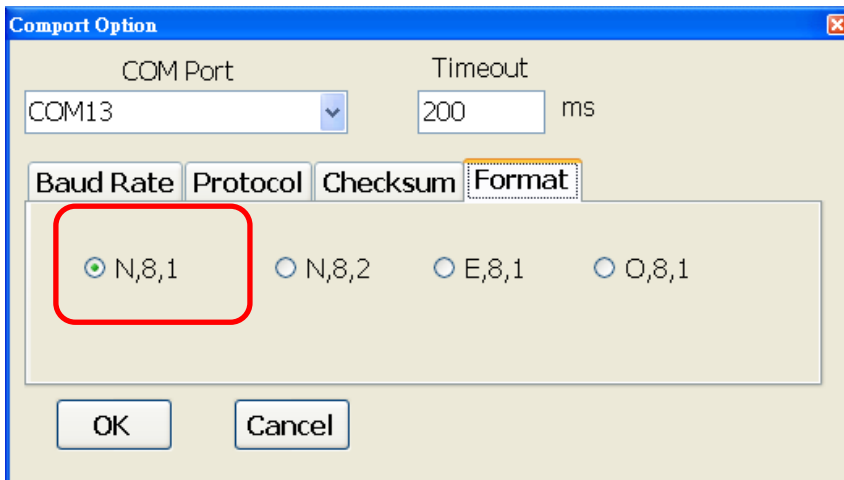

8. Click the Start Search icon.



9. The iSN-101/104 logger searched out will be listed as below.

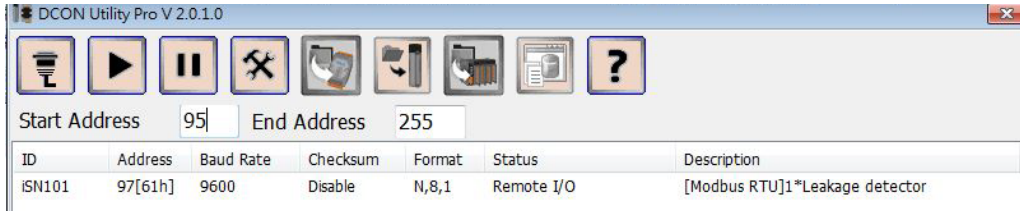

10. Click the module name to configure the logger.

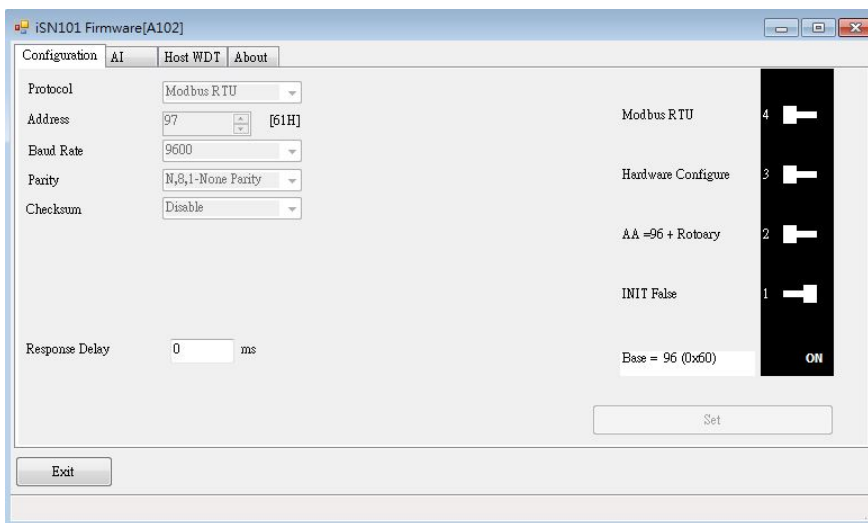

Note

The Protocol/Baud Rate/Parity/Checksum items marked with "(INIT*)" means that when any of those items needs be modified, the pin 4.INIT needs to be set in ON position and power cycle the logger, then the item can be modified. After complete setting, set the pin 4.INIT back to OFF position and power cycle the logger again to take the setting effect.

➤ **AI tab (iSN-101)**

Leakage Detect Resistance

Adjust the Beeper On Alarm Time
Threshold Index(Sensitivity)

Leak Alarm Mode

Sound Off Button Status

Leak Alarm Mode & Status

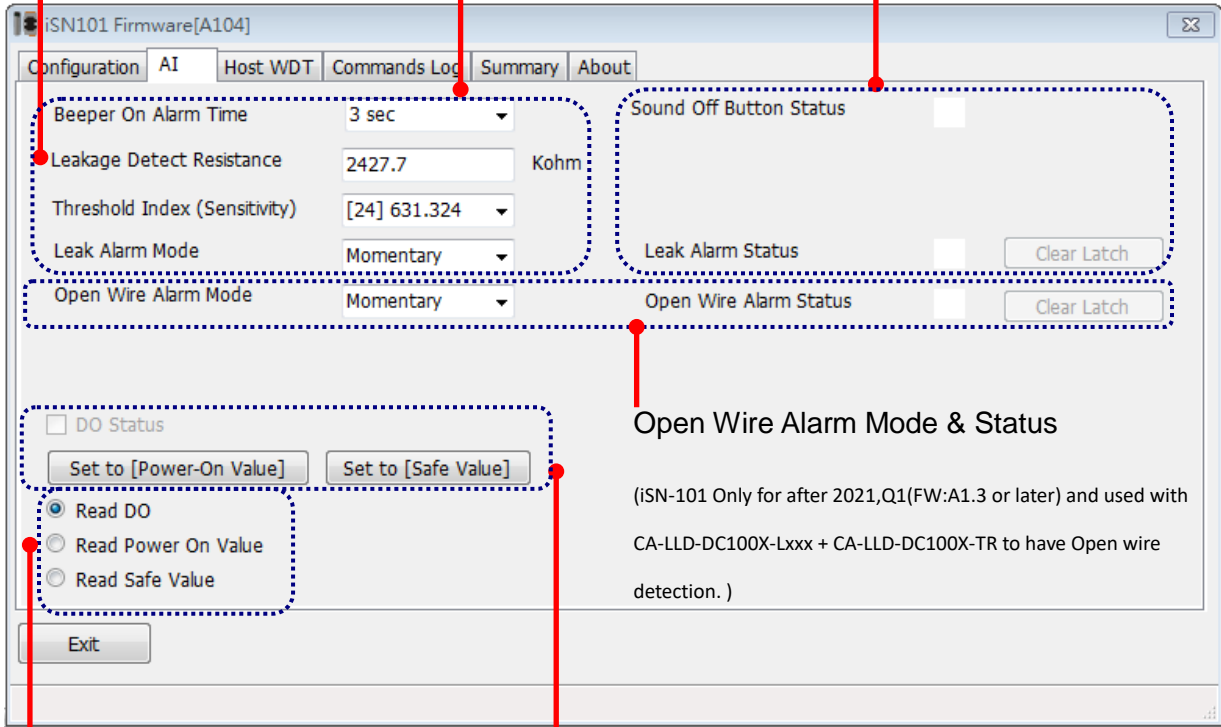

Select one of the radio button and the checkbox next to DO will display the setting for selected item.

DO Status (On/Off)

When the buttons are clicked, the DO status will be set as the Power On value or Safe value.

➤ **AI tab (iSN-104)**

Leakage Detect Resistance

Adjust the Leak Alarm Mode

Adjust the Wire Alarm Mode

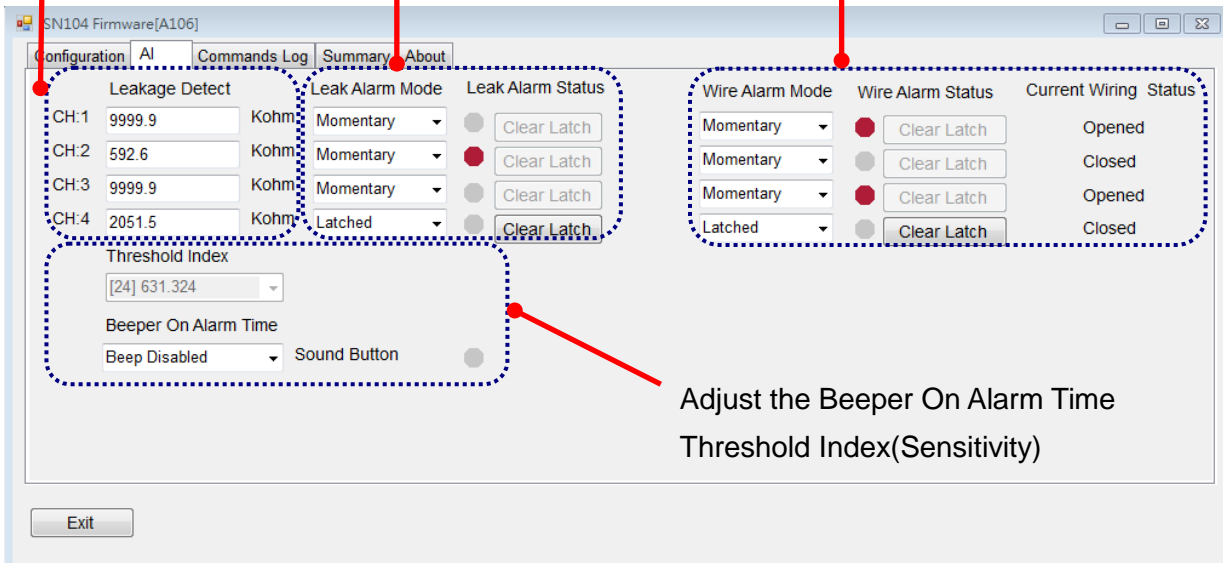

Adjust the Beeper On Alarm Time
Threshold Index(Sensitivity)

➤ Host Watchdog

Host Watchdog is used to monitor the RS-485 communication status; if the host (PC) does not send command “~**” in the time period of WDT Timeout setting, the enabled Host Watchdog will announce the timeout error and turn the relay output to Safe value to avoid an unsafe act. Users can not control the relay until the command “~AA1” is sent to clear the WDT timeout status.

On this tab:

1. Set the time period for WDT timeout, check the checkbox next to Enable WDT and click the Set WDT button to enable the Host watchdog.
2. Check the checkbox next to Send Host OK to send the “~**” command.
3. Uncheck the checkbox next to Send Host OK to stop sending ~** command, the Host watchdog timeout will occur and relay will turn to Safe value.
4. Click the Reset WDT button to clear the Host watchdog timeout status.
5. Uncheck the checkbox next to Enable WDT and click the Set WDT button to disable the Host watchdog.

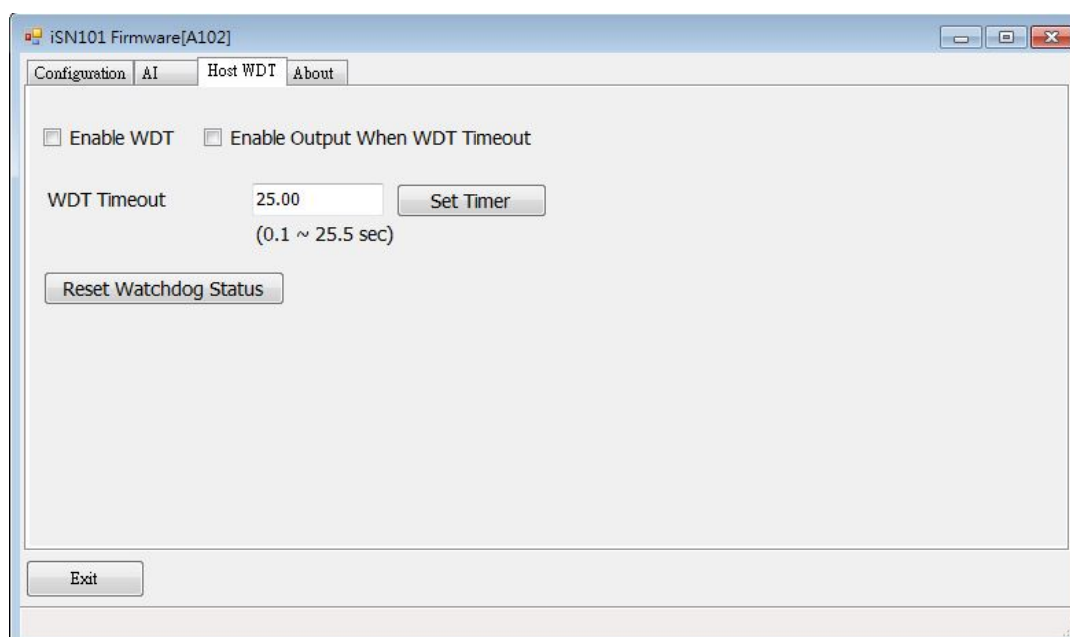

Note

The relay will not turn to Safe value when alarm for detected liquid is enabled. If the alarm is enabled, the relay will be linked to the Alarm status. In case an Alarm occurs, the relay turns ON, it can be used to turn on the user's alarm light or beeping alarm or other device.

➤ INIT

In case of the following situations, users have to set the pin 4.INIT on DIP Switch in the ON position and power-cycle the iSN-101/104 module:

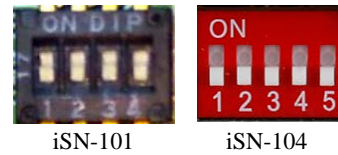

- Change protocol from PC
- Change DCON configuration such as baud rate, parity and checksum
- Communication failure with a iSN-101/104 module.

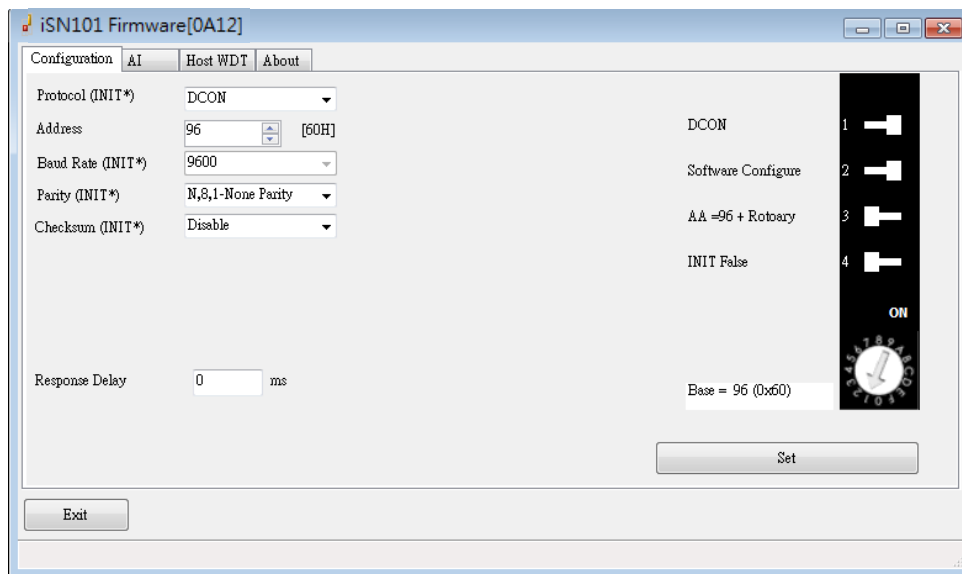

When a iSN-101/104 module is powered-on with the pin 4.INIT in ON position, the protocol is DCON, address is 0, Baud Rate is 9600 bps, Parity is set to N/8/1 and Checksum is disabled.

After configuring the communication parameters, click the *Set Module Configurations* button, set the INIT to OFF position and power-cycle the iSN-101/104 to take the settings effect.

Note

The INIT switch does not need to be set in the ON position when changing the address, baudrate and parity for ModbusRTU communication; users only have to power-cycle the module after complete configuration.

Appendix A: DCON Command Sets

A-1. iSN-101/104 DCON Command Sets

Command	Description
#AA	<p>Read All Analog Inputs</p> <p>response</p> <p>iSN-101: >(resistance in k ohm)(threshold index by VR) in engineering format</p> <p>iSN-104: >(resistance of ch0 in k ohm)(resistance of ch1 in k ohm)(resistance of ch2 in k ohm)(resistance of ch3 in k ohm)(threshold index by VR) in engineering format</p>
#AAi	<p>Read Channel Analog Inputs</p> <p>iSN-101: i = 0 for resistance in k ohm, 1 for threshold index by VR</p> <p>iSN-104: i = 0 to 3 for channel resistance in k ohm, 4 for threshold index by VR</p>
@AABA	<p>Read beep on alarm time</p> <p>response</p> <p>!aahh, hh in hex, 0: disabled, 1 ~ 250: beep on alarm time in seconds, 251: beep on alarm continuously</p>
@AABAh	<p>Set beep on alarm , hh in hex, 0: disabled,</p> <p>1 ~ 250: beep on alarm time in seconds, 251:beep on alarm continuously</p>
@AACH	<p>Clear all high latch (to current)</p>
@AACHi	<p>Clear channel high latch (to current)</p> <p>iSN-101: i = 0 for resistance in k ohm, 1 for threshold index by VR, iSN-104: i = 0 to 3 for channel resistance in k ohm, 4 for threshold index by VR,</p>
@AACL	<p>Clear all low latch (to current)</p>

@AACLi	Clear channel low latch (to current) iSN-101: i = 0 for resistance in k ohm, 1 for threshold index by VR, iSN-104: i = 0 to 3 for channel resistance in k ohm, 4 for threshold index by VR,
@AACLC0	Clear low latched alarm of channel 0
@AADACi	iSN-101: i = 0 for leak alarm, 1 for open wire alarm iSN-104: i = 0 to 3 for leak alarm, 4 to 7 for open wire alarm of channel 0 to 3
@AADI	Read DI & DO Response !AA0OOII
@AADOhh	Set DO (For iSN-101 Only)
@AAEATCi*	Enable AI alarm of channel i, T->M: momentary alarm, L: latched alarm iSN-101: i = 0 for leak alarm i = 1 for open wire alarm* iSN-104: i = 0 to 3 for leak alarm, 4 to 7 for open wire alarm of channel 0 to 3
@AAIL	Read IIR level
@AAILh	Set IIR level
@aaLT	Read leak threshold index
@aaLTV	Read leak threshold index by VR
@aaLTxx	Set leak threshold index, xx in hex, 00 ~ 18
@AARACi	Read AI alarm enabled/disabled status of a channel @AARACi response !AAAn, 0: disabled, 1: momentary, 2: latched iSN-101: i = 0 for leak alarm i = 1 for open wire alarm*

	iSN-104: i = 0 to 3 for leak alarm, 4 to 7 for open wire alarm of channel 0 to 3
@AARAO	Read AI alarm status @AARAO response !AAHLL iSN-101: bit 0 of LL: leak alarm bit 1 of LL: open wire alarm* iSN-104: bit 0 to 3 of LL: leak alarm bit 4 to 7 of LL: open wire alarm
@AARH	Read all high latch values
@AARHi	Read channel high latch value
@AARL	Read all low latch values
@AARLi	Read channel low latch value
%AANNTCCFF	Set configuration FF: bit 6: 1-> checksum enabled
\$AAB*	Read open wire status response iSN-101: !AAHH, bit 0 of HH: open wire status, 1 for open wire iSN-104: !AAHH, bit 0 to 3 of HH: open wire status, 1 for open wire
\$aa0Ci	Span calibration
\$aa1Ci	Zero calibration
\$aa2	Read configuration
\$aa5	Read reset status
\$aaF	Read firmware version
\$aaI	Read INIT status
\$aaM	Read module name
\$aaPN	Set Modbus RTU/DCON protocol
\$aaP	Read Modbus RTU/DCON protocol
\$aaS1	Reload factory calibration parameters
~aaAi	Read ADC raw data
~aaE0	Disable calibration

~aaE1	Enable calibration
~aaI	Soft INIT
~aaM	Read OEM module name
~aaO(data)	Set module name
~aaRD	Read response delay time in ms
~aaRDxx	Set response delay time in ms, xx in hex, 00 ~ 1E
~AARS	Read DIP switch Response !AAdddd (rotary, DIP switch)
~aaSR	Software reset
~aaTxx	Set soft INIT timeout in s, xx in hex
~aa0	Read host watchdog status
~aa1	Clear host watchdog timeout status
~aa2	Read host watchdog setting
~aa3ett	Set host watchdog setting
~aa4	Read power on and safe DO Response !AAPPSS
~aa5PPSS	Set power on and safe DO
*Note : DCON firmware must be version A103 or later with Terminal Resistor supports open wire function. (for iSN-101 only)	

Baud Rate Setting (CC)

Bits 5:0

Baud rate, 0x03 ~ 0x0A

Code	0x03	0x04	0x05	0x06
Baud	1200	2400	4800	9600
Code	0x07	0x08	0x09	0x0A
Baud	19200	38400	57600	115200

Bits 7:6

00: no parity, 1 stop bit

01: no parity, 2 stop bits

10: even parity, 1 stop bit

11: odd parity, 1 stop bit

Data Format Setting (FF)

Bit 6

0: checksum disabled

1: checksum enable

Appendix B: ModbusMasterToolPC

ModbusMasterToolPC is a free, easy-to-use tool for Modbus communication and diagnosing the wiring. It is located in the company CD:

CD:\Napdos\iSN-101/104\utility\ and needless to install

This section intends to guide the steps for creating the Modbus communication with iSN-101/104 logger.

1. Launch the ModbusMasterToolPC.exe.
2. Select **New** in the File menu.

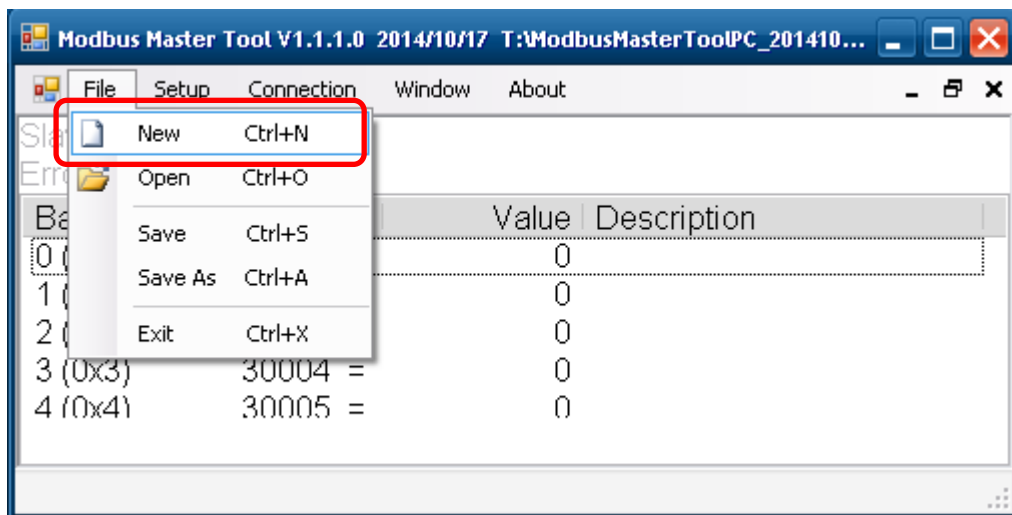

3. Input the file name and click on the **Save** button.

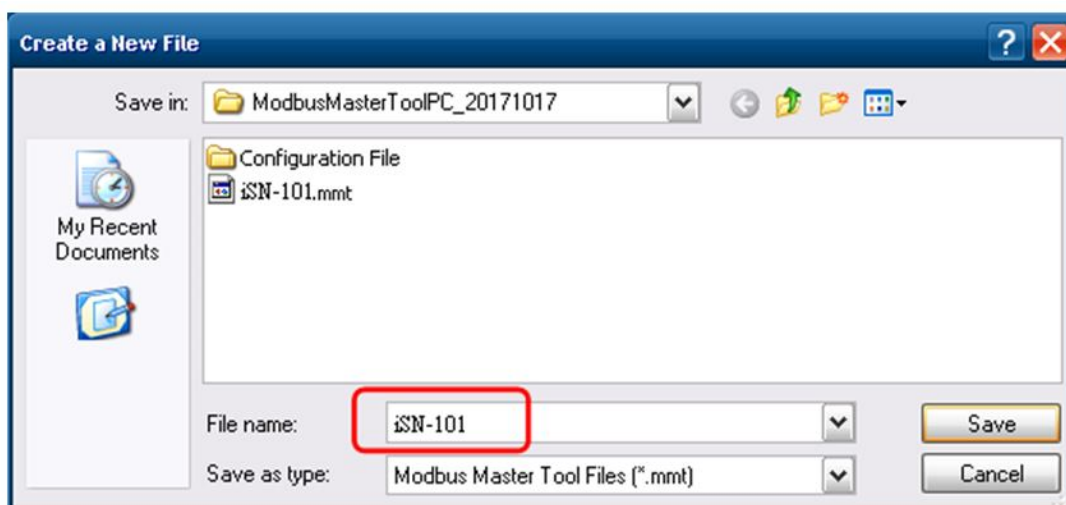

4. Select **Connect** in the *Connection* menu.

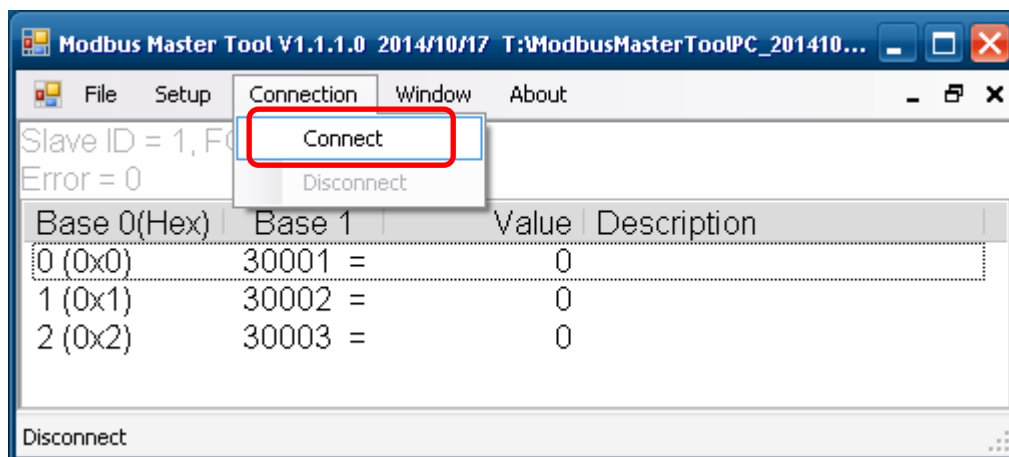

5. Select the communication interface. When using RS-485 as the interface, select the COM port, check the RTU mode and click on the **OK** button.

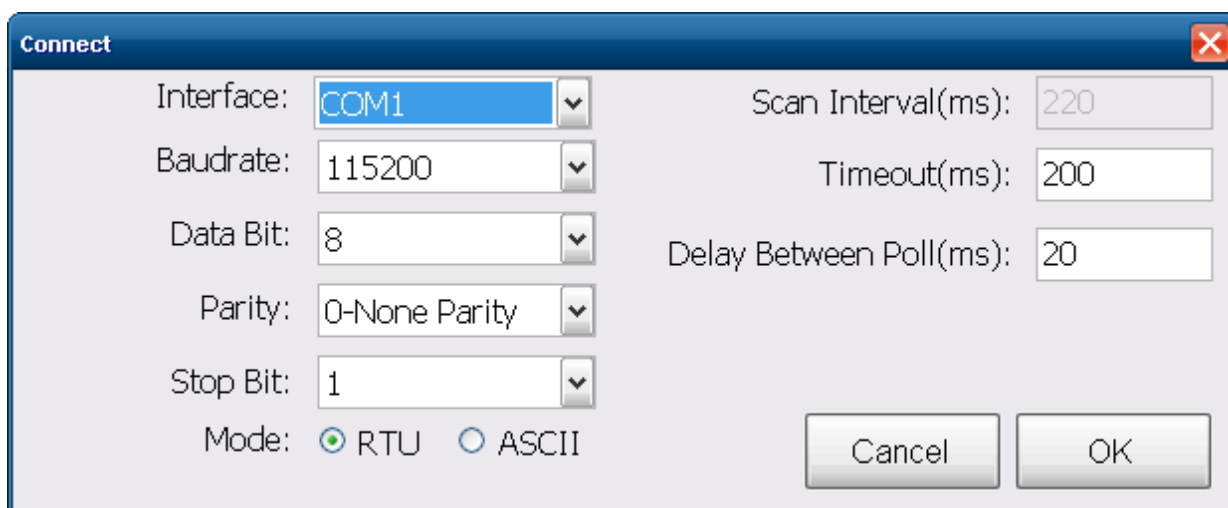

6. Select **Definition** in the *Setup* menu.

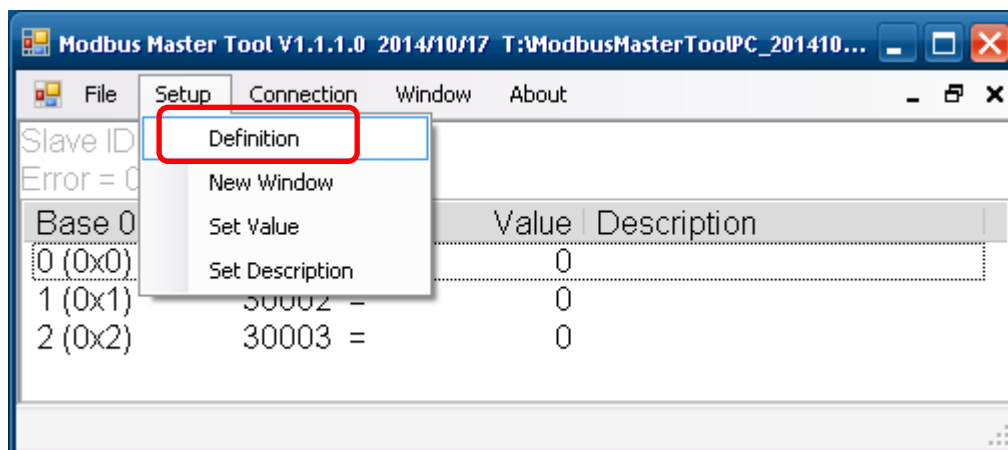

7. Select the Modbus function code, input the start address and length, and click on the **OK** button.

Definition

Slave ID: 1

Function: 04 Read Input Registers

Address: 0

Length: 10

Format: Singed Int16

Descriptions Clear All Descriptions

OK

Cancel

8. Read data.

Modbus Master Tool V1.1.1.0 2014/10/17 T:\ModbusMasterToolPC_201410...

File Setup Connection Window About

Slave ID = 1, FC = 4

Error = 0

Base 0(Hex)	Base 1	Value	Description
0 (0x0)	30001 =	779	
1 (0x1)	30002 =	4199	
2 (0x2)	30003 =	2350	
3 (0x3)	30004 =	7430	
4 (0x4)	30005 =	983	

Connection is established. IP= 10.1.0.131

9. Write data to Holding Register or Coil Status

1. Highlight the Modbus address in the Holding Register or Coil Status list
2. Select **Set Value** in the *Setup* menu.
3. Input the data in the Value box and click on the **OK** button

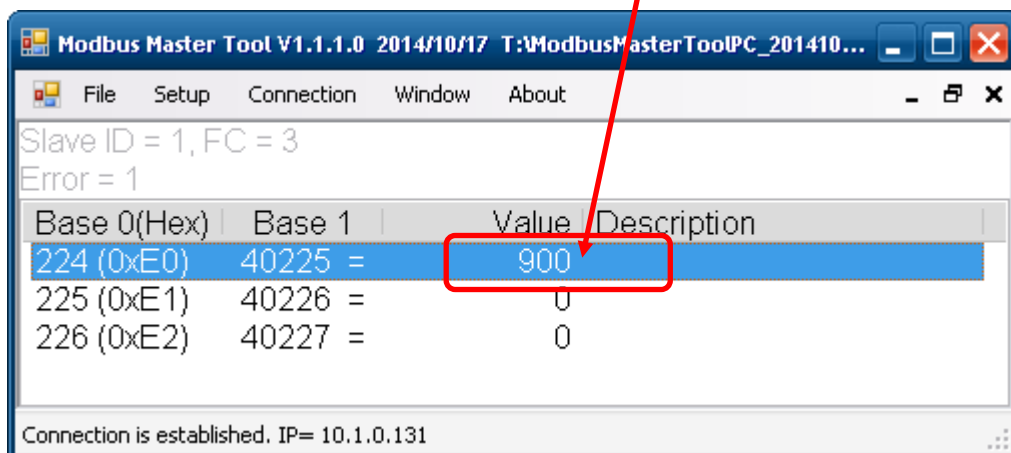
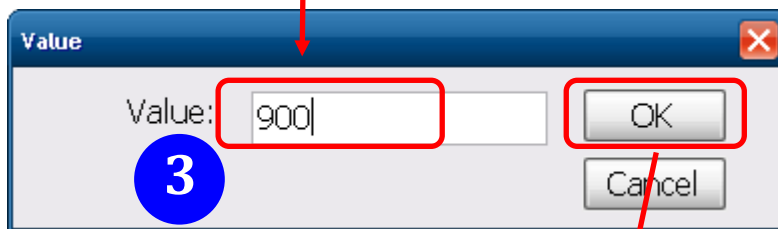
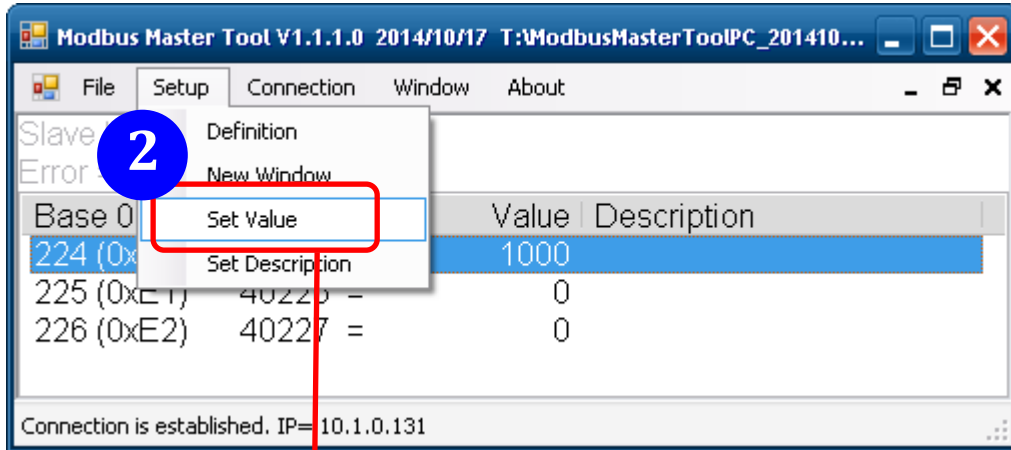

Appendix C: Modbus Address Table

C-1. iSN-101/104 Modbus Address Mappings (Base 1)

Address	Description	Attribute
30001 ~ 30004 40001 ~ 40004	Resistance of sensor 0 to 3 in 100 ohm (iSN-101:0)	R
30002 40002	Leak threshold index by VR, 0 to 24	R
40481	Firmware version (low word)	R
40482	Firmware version (high word)	R
40483	Module name (low word)	R
40484	Module name (high word)	R
40485	RS-485 module address, 1 to 247	R/W
40486	RS-485 baud rate and parity settings Bits 5:0 Baud rate, valid range: 3 ~ 10 Bits 7:6 00: no parity, 1 stop bit 01: no parity, 2 stop bit 10: even parity, 1 stop bit 11: odd parity, 1 stop bit	R/W
40488	RS-485 response delay time in ms, valid range, 0 ~ 30	R/W
40489	RS-485 host watchdog timeout value, 0 ~ 255, in 0.1s	R/W
40492	RS-485 host watchdog timeout count, write 0 to clear	R/W
40496	Leak threshold index, 0 to 24	R/W
40497	Beep on alarm, 0: disable, 1 to 250: beep on alarm time in seconds, 251: beep on alarm continuously	R/W
30513 ~ 30516 40513 ~ 40516	High latched analog input value of resistance of sensor 0 to 3 in 100 ohm (iSN-101:0)	R
30545 ~ 30548 40545 ~	iSN-104: Low latched analog input value of resistance of sensor 0 to 3 in 100 ohm (iSN-101: 0)	R

40548		
-------	--	--

Address	Description	Attribute
00001	Digital output value of channel 0	R/W
00033 10033	Status of the beep off switch	R
00129	Safe value of digital output channel 0	R/W
00161	Power on value of digital output channel 0	R/W
00225* 10225	Status of the open wire	R
00257	Protocol, 0: DCON, 1: Modbus RTU	R/W
00260	Modbus RTU host watchdog mode 0: same as I-7000 1: can use AO and DO command to clear host watchdog timeout status Only for Modbus RTU protocol	R/W
00261	RS-485 host watchdog mode, 1: enable, 0: disable. Only for Modbus RTU protocol	R/W
00262	Write 1 to play notification sound	W
00270	Host watch dog timeout status, write 1 to clear host watch dog timeout status Only for Modbus RTU protocol	R/W
00273	Reset status, 1: first read after powered on, 0: not the first read after powered on	R
00280	Write 1 to clear all high latched analog input values	W
00281	Write 1 to clear all low latched analog input values	W
00289	Low alarm status of leak sensor. Write 1 to clear low latched alarm.	R/W
00290*	Alarm status of open wire. Write 1 to clear latched alarm.	R/W
00321 ~ 00324	Enable/disable leak alarm of leak sensor 0 to 3 (iSN-101:0)	R/W
00322*	Enable/disable alarm of open wire (for iSN-101 only)	R/W
00325 ~ 00328	Enable/disable open wire alarm of leak sensor 0 to 3 (for iSN-104 only)	R/W
00337 ~ 00340	Leak alarm type, momentary or latched, of leak sensor 0 to 3 (iSN-101:0)	R/W
00338*	Alarm type, momentary or latched, of open wire (for iSN-101 only)	R/W
00341 ~	Open wire alarm type, momentary or latched, of leak sensor 0 to	R/W

00344	3(for iSN-104 only)	
00385 ~ 00388	Write 1 to clear high latched analog input value of sensor 0 to 3(iSN-101:0)	W
00417 ~ 00420	Write 1 to clear low latched analog input value of sensor 0 to 3(iSN-101:0)	W
* iSN-101 for firmware version A103 and later only		

DIP Switch setting

1	Protocol	ON: DCON, OFF: Modbus RTU
2	Configuration	ON: by software, OFF: by hardware
3	Address	ON: added by 16, OFF: added by 0
4	INIT mode	ON: INIT, OFF: Normal
5	Sound	ON: turn on, OFF: turn off (for iSN-104 only)

Base address: 96 (0x60)

Revision History

Revision	Date	Description
1.0.0	2017/10	First released
1.1.0	2021/11	Add: open wire function (* iSN-101 for firmware version A103 and later only) Add: iSN-104
2.0.0	2022/02	update