

# tBOX322-882-FL

Fanless Embedded System with  
4th Generation Intel® Core™ Processor  
for Railway PC

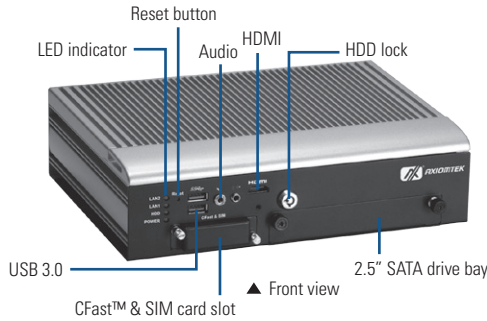

## Specifications

Standard Color	Silver-Black				
Construction	Aluminum extrusion and heavy-duty steel, IP40				
CPU	4th Generation Intel® Core™ processor ; 4th generation Intel® Core™ i7-4650U (1.7 GHz up to 3.3 GHz) or 4th generation Intel® Core™ i3-4010U (1.7 GHz)				
System Memory	DDR3L-1600 4 GB or 8 GB DRAM				
Chipset	SoC integrated				
BIOS	AMI UEFI BIOS with OA 3.0 built				
System I/O Outlet	<table border="0"> <tr> <td>Rear Side</td> <td> <ul style="list-style-type: none"> <li>2 x GbE LAN (M12 A-coded)</li> <li>2 x isolated RS-232/422/485</li> <li>1 x isolated DI/DO (6-in/2-out)</li> <li>1 x USB 2.0 (M12 A-coded)</li> <li>1 x audio (mic-in/line-out, M12 D-coded)</li> <li>1 x DVI-I</li> <li>1 x VDC power input (M12 A-coded)</li> <li>1 x remote power switch</li> <li>4 x antenna opening</li> <li>1 x power switch</li> </ul> </td> </tr> <tr> <td>Front Side</td> <td> <ul style="list-style-type: none"> <li>2 x USB 3.0</li> <li>2 x audio (mic-in/line-out, screw type)</li> <li>1 x HDMI</li> <li>1 x reset switch</li> <li>1 x 2.5" SATA drive tray</li> <li>1 x CFast™ slot + 2x SIM card sockets</li> </ul> </td> </tr> </table>	Rear Side	<ul style="list-style-type: none"> <li>2 x GbE LAN (M12 A-coded)</li> <li>2 x isolated RS-232/422/485</li> <li>1 x isolated DI/DO (6-in/2-out)</li> <li>1 x USB 2.0 (M12 A-coded)</li> <li>1 x audio (mic-in/line-out, M12 D-coded)</li> <li>1 x DVI-I</li> <li>1 x VDC power input (M12 A-coded)</li> <li>1 x remote power switch</li> <li>4 x antenna opening</li> <li>1 x power switch</li> </ul>	Front Side	<ul style="list-style-type: none"> <li>2 x USB 3.0</li> <li>2 x audio (mic-in/line-out, screw type)</li> <li>1 x HDMI</li> <li>1 x reset switch</li> <li>1 x 2.5" SATA drive tray</li> <li>1 x CFast™ slot + 2x SIM card sockets</li> </ul>
Rear Side	<ul style="list-style-type: none"> <li>2 x GbE LAN (M12 A-coded)</li> <li>2 x isolated RS-232/422/485</li> <li>1 x isolated DI/DO (6-in/2-out)</li> <li>1 x USB 2.0 (M12 A-coded)</li> <li>1 x audio (mic-in/line-out, M12 D-coded)</li> <li>1 x DVI-I</li> <li>1 x VDC power input (M12 A-coded)</li> <li>1 x remote power switch</li> <li>4 x antenna opening</li> <li>1 x power switch</li> </ul>				
Front Side	<ul style="list-style-type: none"> <li>2 x USB 3.0</li> <li>2 x audio (mic-in/line-out, screw type)</li> <li>1 x HDMI</li> <li>1 x reset switch</li> <li>1 x 2.5" SATA drive tray</li> <li>1 x CFast™ slot + 2x SIM card sockets</li> </ul>				
Watchdog Timer	255 levels, 0 ~ 255 sec./min.				
Storage	1 x 2.5" SATA HDD (Removable and with lock protection) 1 x CFast™				
Expansion Interface	3 x PCI Express Mini Card 2 x SIM card slots				
System Indicator	1 x green LED for system power on 1 x green LED for HDD active 1 x green LED for LAN1 link 1 x green LED for LAN2 link				
Power Supply	Power input : 14VDC ~ 32VDC (isolation) Typical : 24VDC				
Power Consumption	1.8A @ 24V				
Operating Temperature	-40°C ~ +70°C (-40°F ~ +158°F) W/T SSD -25°C ~ +55°C (-13°F ~ +131°F) W/T HDD				
Storage Temperature	-40°C ~ +80°C (-40°F ~ +176°F)				
Humidity	5% ~ 95%, non-condensing				

## Features

- EN50155, EN50121 certificates
- Fanless with operating temperature range of -40°C ~ +70°C (EN50155 class TX)
- Comply to fire protection of railway vehicles Europe standard PrCEN TS 45545-2
- 4th generation Intel® Core™ i7 or Core™ i3 processor
- High performance DDR3L 4 GB or 8 GB memory onboard
- Isolated RS-232/422/485 and DIO ports
- Supports USB 3.0 and SATA3 interface
- 1 removable & lockable 2.5" SATA HDD and 1 CFast™
- 3 internal PCI Express Mini Card slot and 2 SIM slots
- Lockable I/O interface and M12 type LAN, audio, power and USB connector
- Suspension designed for HDD

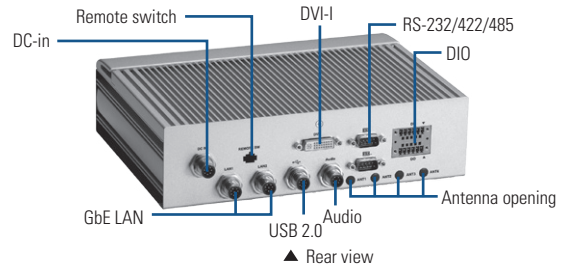

Vibration Endurance	3 Grms with SSD or CFast™ (5-500Hz, X, Y, Z directions) 2 Grms with HDD (5-500Hz, X, Y, Z directions)
Dimensions	244 mm (9.6") (W) x 180.5 mm (7.1") (D) x 65.1 mm (2.56") (H)
Weight (net/gross)	2.94 kg (6.48 lb)/ 3.94 kg (8.68 lb)
Certificate	CE (Class A), EN50155, EN50121, EN45545-2, EN60950-1 compliance
EOS Support	WEBS, WES 7, Linux

## Ordering Information

Standard	
tBOX322-882-FL-i7-DC	Fanless railway embedded system with 4th generation Intel® Core™ i7-4650U, 4 GB DDR3L, 2 GbE LAN (M12), 2 isolated COM and CFast™
tBOX322-882-FL-i3-DC	Fanless railway embedded system with 4th generation Intel® Core™ i3-4010U, 4 GB DDR3L, 2 GbE LAN (M12), 2 isolated COM and CFast™
tBOX322-882-FL-8GB-i7-DC	Fanless railway embedded system with 4th generation Intel® Core™ i7-4650U, 8 GB DDR3L, 2 GbE LAN (M12), 2 isolated COM and CFast™
tBOX322-882-FL-8GB-i3-DC	Fanless railway embedded system with 4th generation Intel® Core™ i3-4010U, 8 GB DDR3L, 2 GbE LAN (M12), 2 isolated COM and CFast™

Optional	
2.5" SATA HDD/SSD	16 GB or above
CFast™	1 GB or above
3G module	
Wi-Fi module	
Wi-Fi Bluetooth	
GPS module	
M12 Gigabit LAN cable	
M12 power cable	
M12 USB cable	
M12 audio cable	
Remote switch cable	

\*Specifications and certifications are based on options and may vary.

\* All specifications and photos are subject to change without notice.

## Expansion & Installation

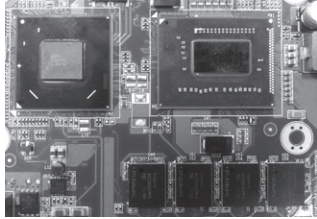

Onboard 4th generation Intel® Core™ CPU and 4 GB/ 8 GB DDR3L DRAM



Swappable and lockable SATA3 HDD/SSD, Audio jack, USB 3.0 and CFast™



M12 type for Gigabit LAN, USB 2.0 and audio ports

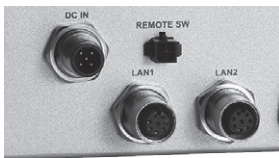

M12 type power connector and remote switch connector

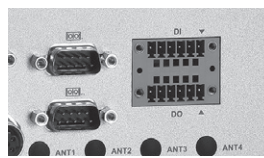

Isolated RS-232/422/485 and DIO ports

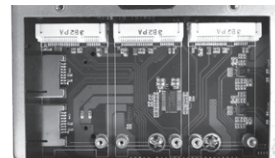

3 x Mini Card slots with 2 x SIM slot

## Packing List

- 1 x quick manual
- 1 x driver CD
- 1 x screw pack
- 4 x foot pad
- 1 x wall-mount kit

## Power Protection

- DC Version**
- SCP (short circuit protection)
  - OVP (over voltage protection)
  - UVP (under voltage protection)

## Dimensions

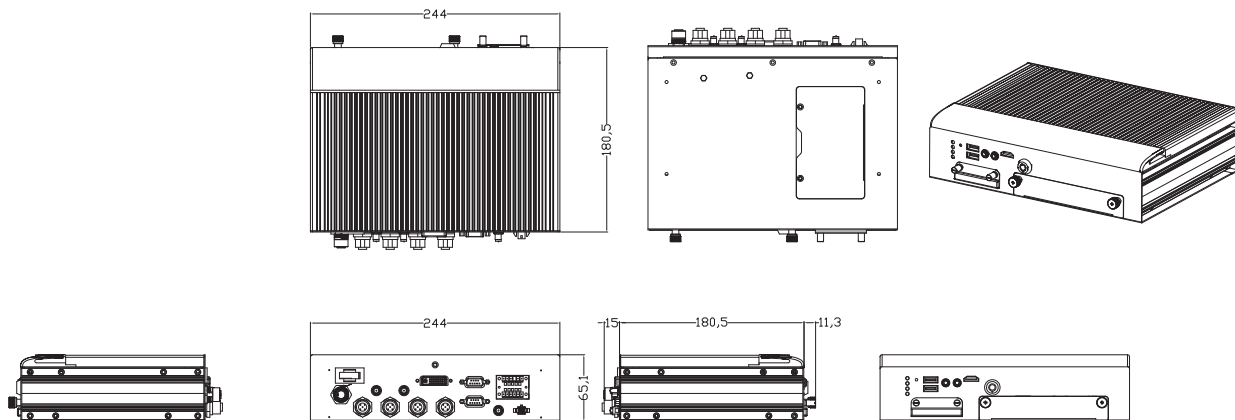

Overview

Embedded Systems

2

Embedded Systems for Transportation

Embedded Field Controllers

Industrial Firewall

Digital Signage Solutions

Embedded MicroBoxes

Industrial Barebone Systems

Industrial Chassis

Backplanes

Power Supplies

Peripherals & Accessories

