

For more than two decades, ceramic filter technology has been instrumental in the proliferation of solid state electronics. A view of the future reveals that even greater expectations will be placed on piezoelectric material in the area of new applications and for more stringent performance criteria in current products. Traditionally, nearly all low and high-end AM and FM commercial radios use ceramic band-pass filters. However, applications are also found in cordless telephones, cellular systems, 2-way communications, and the television industry.

As a world leader in the development of piezo ceramic filter technology, Murata Electronics had been able to develop specialized ceramic materials which when combined with an advance filter design have resulted in a complete line of practical, inexpensive ceramic filters for entertainment and communications applications. In this catalog, the principle of ceramic filters, the design of representative test circuits

and specifications concerning various models are described.

PIEZOELECTRIC THEORY AS APPLIED TO CERAMIC FILTERS

All ceramic filters derive their basic frequency selectivity from a mechanical vibration resulting from a piezoelectric effect. While a total theoretical analysis of piezoelectric technology as applied to ceramic filters is very complex, it can be shown as the equivalent circuit as illustrated in Fig. 430-1. This equivalent circuit represents a typical two-terminal filter, a device which forms the basic building block for more complex filters.

The resonant frequency of this device is calculated by the equation:

$$f_r = \frac{1}{2\pi \sqrt{L_1 C_1}}$$

The anti-resonant frequency is expressed as:

$$f_a = \frac{1}{2\pi \sqrt{L_1 \frac{C_1 C_0}{C_1 + C_0}}}$$

This filter exhibits the impedance shown in Fig. 430-2.

Two-terminal filters are typically used as emitter bypasses and they exhibit the frequency characteristics shown in Fig. 430-3.

Three-terminal ceramic filters can be used as inter-stage coupling devices as shown in Fig. 430-4. By using our filters in this manner, increased selectivity, improved band pass characteristics, reliability and stability can be obtained without increasing circuit complexity or parts count.

By cascading two or more filters as shown in Figs. 431-5 and 6, Murata can greatly enhance selectivity. By controlling the coefficient of electromechanical coupling between the filter elements, bandwidth can be "peaked" or "flattened." Typical 455kHz response curves are shown in Figs. 431-7 and 8.

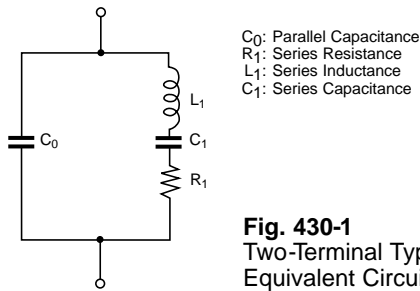

Fig. 430-1
Two-Terminal Type
Equivalent Circuit

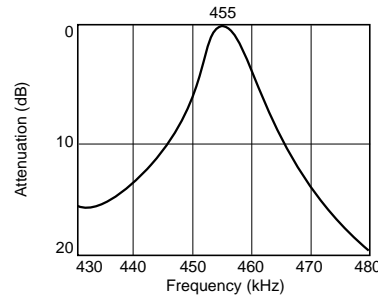

Fig. 430-3
Typical Attenuation Characteristics
For A 455kHz (Two-Terminal)
Ceramic Filter

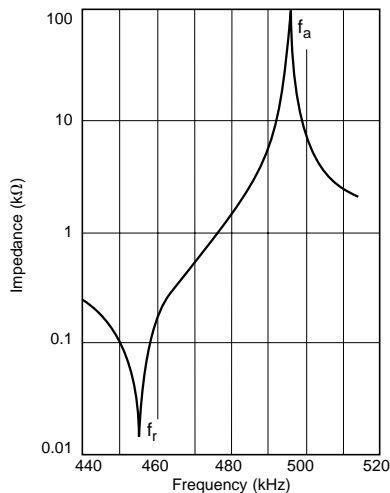

Fig. 430-2
Typical Impedance vs
Frequency Response Curve For
A Two-Terminal Device

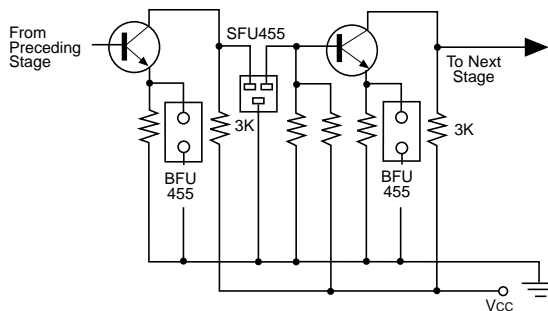

Fig. 430-4
Three-Terminal
Filter Used As Inter-Stage
Coupling Device

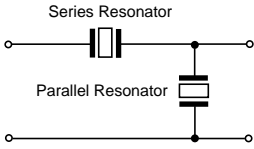

Fig. 431-5
Ladder Connection

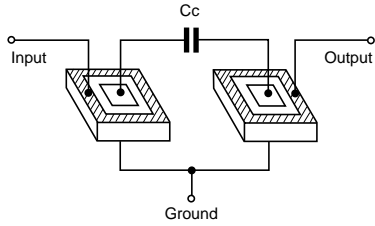

Fig. 431-6
Cascade Connection

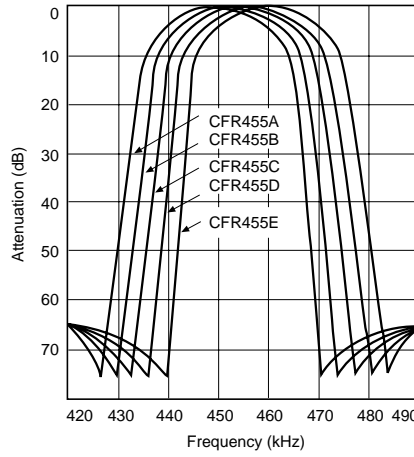

Fig. 431-7
Typical Response Curves For
CFR455 A-E Series Ceramic Filters

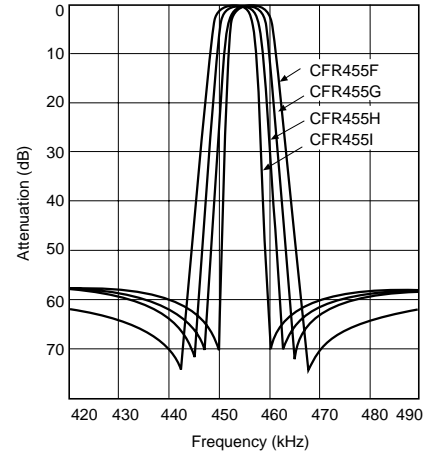

Fig. 431-8
Typical Response Curves For
CFR455 F-I Series Ceramic Filters

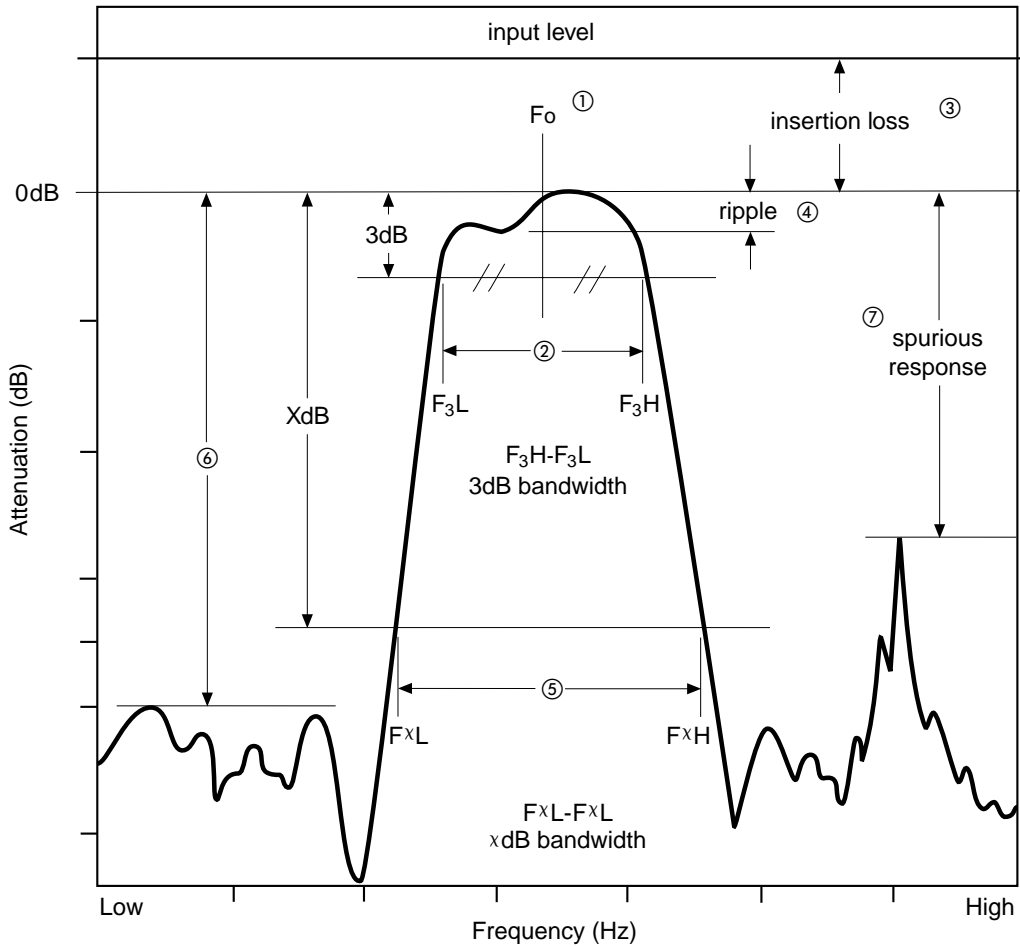

Fig. 431-9
Graphical Representation of Ceramic Filter Terminology

CERAMIC FILTER TERMINOLOGY

Although the previous section has presented a concise discussion of piezoelectric theory as applied to ceramic filter technology, it is necessary that the respective terminology used in conjunction with ceramic filters be discussed before any further examination of ceramic filter technology is made.

Using Fig.431-9 as a typical model of a response curve for a ceramic filter, it can be seen that there are a number of relevant factors to be considered in specifying ceramic filters. These include: center frequency, pass-bandwidth,

insertion loss, ripple, attenuation bandwidth, stopband attenuation, spurious response and selectivity. Although not all of these factors will apply to each filter design, these are the key specifications to consider with most filters. From the symbol key shown in Table 432-1 below, a thorough understanding of this basic terminology should be possible.

IMPEDANCE MATCHING

As it is imperative to properly match the impedances whenever any circuit is connected to another circuit, any component to another component, or any circuit to another component, it is also important that this be taken into account in using ceramic filters.

Without proper impedance matching, the operational characteristics of the ceramic filters cannot be met.

Fig. 433-12 illustrates a typical example of this requirement.

This example shows the changes produced in the frequency characteristics of the SFZ455A ceramic filter when the resistance values are altered. For instance, if the input/output impedances R_1 and R_2 are connected to lower values than those specified, the insertion loss increases, the center frequency shifts toward the low side and the ripple increases.

TABLE 432-1 – CERAMIC FILTER TERMINOLOGY CHART

| Numbers In Fig. 431-9 | Terminology | Symbol | Unit | Explanation of Term |
|-----------------------|--------------------------------------|----------------|------|---|
| 1 | Center Frequency | f_o | Hz | The frequency in the center of the pass-bandwidth. However, the center frequency for some products is expressed as the point where the loss is at its lowest point. |
| 2 | Pass-bandwidth (3dB Bandwidth) | (3dB) B.W. | Hz | Signifies a difference between the two frequencies where the attenuation becomes 3dB from the level of the minimum loss point. |
| 3 | Insertion Loss | I.L. | dB | Expressed as the input/output ratio at the point of minimum loss. (The insertion loss for some products is expressed as the input/output ratio at the center frequency.) Insertion loss = $20 \text{ LOG } (V_2/V_1)$ in dB. |
| 4 | Ripple | — | dB | If there are peaks and valleys in the pass-bandwidth, the ripple expresses the difference between the maximum peak and the minimum valley. |
| 5 | Attenuation Bandwidth (dB Bandwidth) | 20 (dB) (B.W.) | Hz | The bandwidth at a specified level of attenuation. Attenuation may be expressed as the ratio of the input signal strength to the output signal strength in decibels. |
| 6 | Stopband Attenuation | — | dB | The level of signal strength at a specified frequency outside of the passband. |
| 7 | Spurious Response | SR | dB | The difference in decibels between the insertion loss and the spurious signal in the stopband. |
| | Input/Output Impedance | — | Ohm | Internal impedance value of the input and output of the ceramic filter |
| | Selectivity | — | dB | The ability of a filter to pass signals of one frequency and reject all others. A highly selective filter has an abrupt transition between a passband region and the stopband region. This is expressed as the shape factor—the attenuation bandwidth divided by the pass - bandwidth. The filter becomes more selective as the resultant value approaches one. |

On the other hand, if R_1 and R_2 are connected to higher values other than those specified, the insertion loss will increase, the center frequency will shift toward the high side and the ripple will increase.

DEALING WITH SPURIOUS RESPONSE

Frequently in using 455kHz filters, spurious will cause problems due to the fact that the resonance occurs under an alien vibrating mode or overtone deviating from the basic vibration characteristics. Among available solutions for dealing with spurious response are:

1. The use of a supplementary IFT together with the ceramic filter for suppression of the spurious.
2. The arrangement of two or more ceramic filters in parallel for the mutual cancellation of spurious.
3. The addition of a low-pass or high-pass LC filter for suppression of spurious. Perhaps the most commonly used method of dealing

with spurious is the use of a supplementary IFT in conjunction with the ceramic filter. The before and after effects of the use of an IFT are shown in Figs. 433-10 and 11. In Fig. 433-10, only a single SFZ455A ceramic filter is employed and spurious is a significant problem. With the addition of an IFT, the spurious problem is reduced as is shown in Fig. 433-11.

Although spurious is a significant problem to contend with when using 455kHz ceramic filters, it is not a problem in 4.5MHz and 10.7MHz ceramic filters, as their vibration modes are significantly different.

CONSIDERATIONS FOR GAIN DISTRIBUTION

Since the impedance of both the input and output values of the ceramic filters are symmetric and small, it is necessary that the overall gain distribution within the circuit itself be taken into consideration. For instance, in the discussion concerning proper impedance matching, it was illustrated

that a certain DC loss occurs if the recommended resistance values are not used. This can cause an overall reduction in the gain which could present a problem if no allowances have been made for the corresponding loss. To compensate for this problem, it is recommended that the following be done:

1. The amplifier stage should be designed to compensate for this loss.
2. The ceramic filter should be used in combination with the IFT for minimizing both matching and DC losses. The IFT should be used strictly as a matching transformer and the ceramic filter only for selectivity.

As the use of IC's has become more prevalent with ceramic filters, these considerations have been taken into account. It should be noted that few of the problems discussed above have been realized when more than three (3) IF stages have been employed.

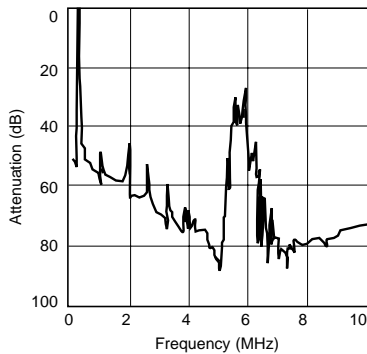

Fig. 433-10
Spurious Response With Model SFZ455A Ceramic Filter

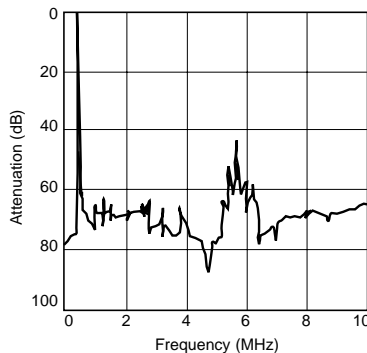

Fig. 433-11
Spurious Response With Model SFZ455A Ceramic Filter And IFT

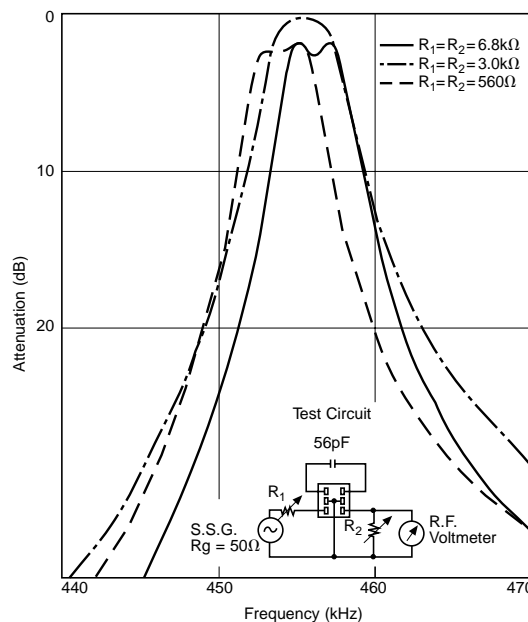

Fig. 433-12
Model SFZ455A Ceramic Filter Matching Impedance vs. Pass-Band Characteristics

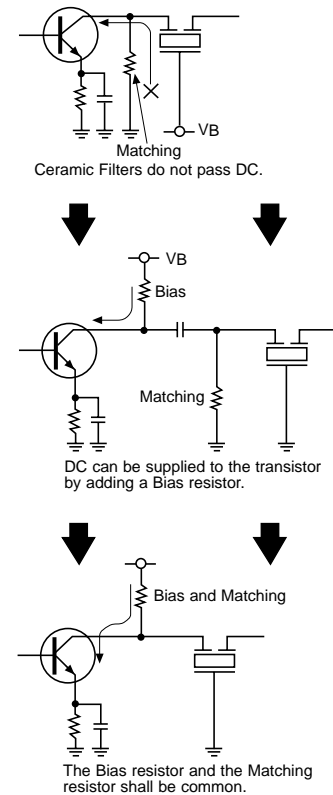

Fig. 433-13
Coupling With A Transistor

CERAMIC FILTERS DO NOT PASS DC

It is important to note in designing circuits that ceramic filters are incapable of passing DC. As is illustrated in Fig. 433-13, in a typical circuit where a transistor is used, a bias circuit will be required to drive the transistor. Since the ceramic filter requires matching resistance to operate properly, the matching resistor shown in the diagram can play a dual role as both a matching and bias resistor.

If the bias circuit is used, it is important that the parallel circuit of both the bias resistance and the transistor's internal resistance be taken into consideration in meeting the resistance values.

This is necessary since the internal resistance of the transistor is changed by the bias resistance. However, when an IC is used, there is no need for an additional bias circuit since the IC has a bias circuit within itself.

Here it is recommended that an IFT be used for impedance matching with the ceramic filter when coupling with a mixer stage, as shown in Fig. 434-14.

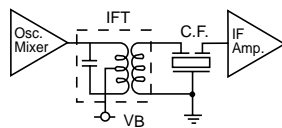

Fig. 434-14
Coupling From Mixer Stage

COUPLING CAPACITANCE

The SFZ455A is composed of two filter elements which must be connected by a coupling capacitor. Moreover, the frequency characteristic changes according to the coupling capacitance (C_c). As shown in Fig. 434-15, the larger the coupling capacitance (C_c) becomes, the wider the bandwidth and more the ripple increases. Conversely, the smaller the coupling capacitance becomes, the narrower the bandwidth becomes and the more the insertion loss increases. Therefore, the specified value of the coupling capacitance in the catalog is desired in determining the specified passband characteristics.

GROUP DELAY TIME CHARACTERISTICS

Perhaps one of the most important characteristics of a transmitting element is to transmit a signal with the lowest possible distortion level. This distortion occurs when the phase shift of a signal which passes through a certain transmitting path is non-linear with respect to the frequency. For convenience, the group delay time (GDT) characteristic is used for the purpose of expressing non-linearity.

It is important to note the relationship between the amplitude and the GDT characteristics when using group delay time terminology. This relationship differs depending upon the filter characteristics. For example, in the Butterworth type, which has a relatively flat top, the passband is flat while the GDT characteristic is extremely curved, as shown in Fig. 434-16. On the other hand, a Gaussian type, is curved in the passband, while the GDT characteristic is flat. With the flat GDT characteristics, the Gaussian type has excellent distortion characteristics.

Since the amplitude characteristics for the Butterworth type is flat in the passband the bandwidth does not change even at a low input level. With the amplitude characteristic for the Gaussian type being curved in the passband, the bandwidth becomes narrow at a low input level and the sensitivity is poor. Therefore, it should be noted that the Gaussian type has a desirable distortion factor while the Butterworth type has the desirable sensitivity.

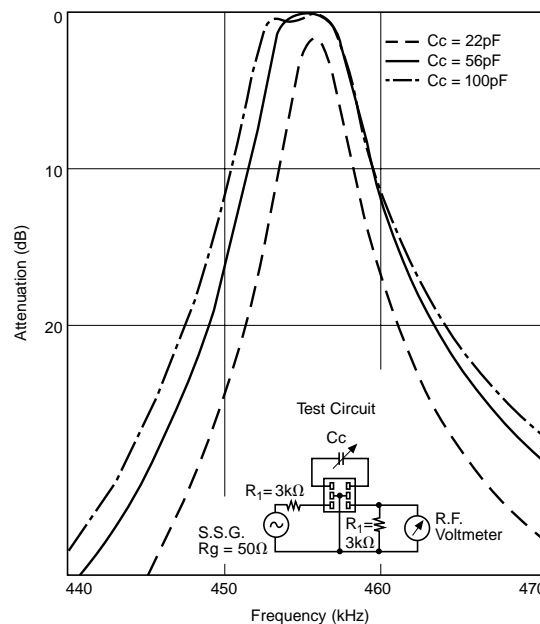
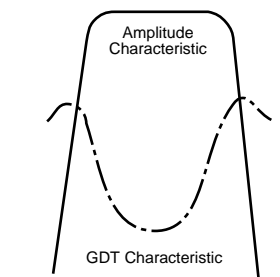
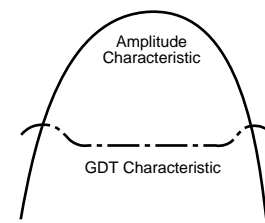

Fig. 434-15
Model SFZ455A Ceramic Filter
Coupling Capacitance vs. Passband
Characteristics



(A) Butterworth Characteristic



(B) Gaussian Characteristic

Fig. 434-16
Relationship Between Amplitude
And GDT Characteristics

PIEZO FILTERS MULTI-ELEMENT FILTERS, RESIN MOLDED, HIGHLY SELECTIVE

CFWS 455kHz



The CFWS 455 line of ceramic filters are 6-element devices connected in ladder form. These compact, highly selective filters are recommended for use in applications ranging from two-way radio to auxiliary filters in high class transceivers. (Also available in 450kHz version.)

SPECIFICATIONS

CFWS 455kHz

| Part Number | Nominal Center Frequency (kHz) | 6dB Bandwidth (kHz) min. | 40dB Bandwidth (kHz) max. | Attenuation 455±100kHz (dB) min. | Ripple (dB) max. kHz | Insertion Loss (dB) max. | Input/Output Impedance (Ohms) |
|-------------|--------------------------------|--------------------------|---------------------------|----------------------------------|----------------------|--------------------------|-------------------------------|
| ★CFWS455B | 455 | ±15 | ±30 | 35 | 3 (455 ± 10) | 4 | 1500 |
| ★CFWS455C | 455 | ±12.5 | ±24 | 35 | 3 (455 ± 8) | 4 | 1500 |
| ★CFWS455D | 455 | ±10 | ±20 | 35 | 3 (455 ± 7) | 4 | 1500 |
| ★CFWS455E | 455 | ±7.5 | ±15 | 35 | 3 (455 ± 5.0) | 6 | 1500 |
| ★CFWS455F | 455 | ±6 | ±12.5 | 35 | 3 (455 ± 4) | 6 | 2000 |
| ★CFWS455G | 455 | ±4.5 | ±10 | 35 | 2 (455 ± 3) | 6 | 2000 |
| CFWS455HT | 455 | ±3 | ±9 | 60 | 2 (455 ± 2) | 6 | 2000 |
| CFWS455IT | 455 | ±2 | ±7.5 | 60 | 2 (455 ± 1.5) | 6 | 2000 |

DIMENSIONS: mm

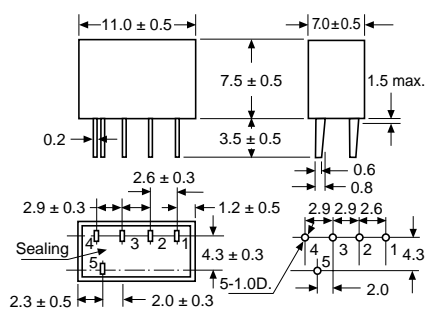

CIRCUIT

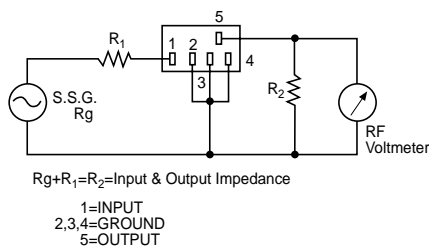

CHARACTERISTICS

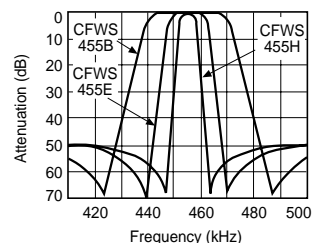

★ Available as standard through authorized Murata Electronics Distributors.

*Note: For safety purposes, connect the output of filters to the IF amplifier through a DC blocking capacitor. Avoid applying a direct current to the output of ceramic filters.

PIEZO FILTERS

CFUM/CFWM 455kHz



The CFUM 455 and CFWM 455 lines of ceramic filters are miniaturized versions of the CFU/CFWS lines. These ultra-miniature versions consume approximately 40% less volume while still offering the same high performance filter characteristics available with the CFU/CFWS lines. (Also available in 450kHz version.)

SPECIFICATIONS

CFUM 455kHz

| Part Number | Nominal Center Frequency (kHz) | 6dB Bandwidth (kHz) min. | 40dB Bandwidth (kHz) max. | Attenuation 455±100kHz (dB) min. | Insertion Loss (dB) max. | Input/Output Impedance (Ohms) |
|-------------|--------------------------------|--------------------------|---------------------------|----------------------------------|--------------------------|-------------------------------|
| ★CFUM455B | 455 | ±15 | ±30 | 27 | 4 | 1500 |
| ★CFUM455C | 455 | ±12.5 | ±24 | 27 | 4 | 1500 |
| ★CFUM455D | 455 | ±10 | ±20 | 27 | 4 | 1500 |
| ★CFUM455E | 455 | ±7.5 | ±15 | 27 | 6 | 1500 |
| ★CFUM455F | 455 | ±6 | ±12.5 | 27 | 6 | 2000 |
| ★CFUM455G | 455 | ±4.5 | ±10 | 25 | 6 | 2000 |
| ★CFUM455H | 455 | ±3 | ±9 | 35 | 6 | 2000 |
| ★CFUM455I | 455 | ±2 | ±7.5 | 35 | 7 | 2000 |

DIMENSIONS: mm

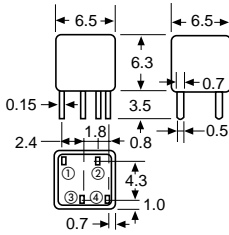

CIRCUIT

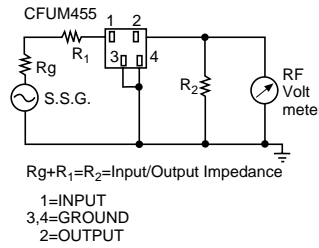

CHARACTERISTICS

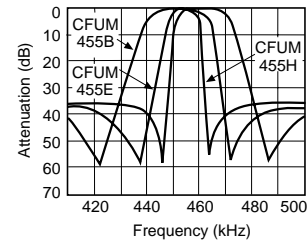

SPECIFICATIONS

CFWM 455kHz

| Part Number | Nominal Center Frequency (kHz) | 6dB Bandwidth (kHz) min. | 40dB Bandwidth (kHz) max. | Attenuation 455±100kHz (dB) min. | Insertion Loss (dB) max. | Input/Output Impedance (Ohms) |
|-------------|--------------------------------|--------------------------|---------------------------|----------------------------------|--------------------------|-------------------------------|
| ★CFWM455B | 455 | ±15 | ±30 | 35 | 4 | 1500 |
| ★CFWM455C | 455 | ±12.5 | ±24 | 35 | 4 | 1500 |
| ★CFWM455D | 455 | ±10 | ±20 | 35 | 4 | 1500 |
| ★CFWM455E | 455 | ±7.5 | ±15 | 35 | 6 | 1500 |
| ★CFWM455F | 455 | ±6 | ±12.5 | 35 | 6 | 2000 |
| ★CFWM455G | 455 | ±4.5 | ±10 | 35 | 6 | 2000 |
| ★CFWM455H | 455 | ±3 | ±9 | 55 | 6 | 2000 |
| ★CFWM455I | 455 | ±2 | ±7.5 | 55 | 7 | 2000 |

• CFWM455□ series filters are 6-element ceramic filters and ultraminiature versions of CFWS455□ series.

DIMENSIONS: mm

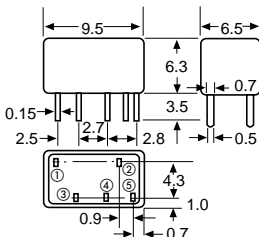

CIRCUIT

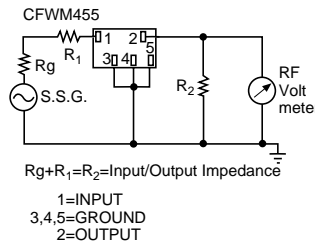

CHARACTERISTICS

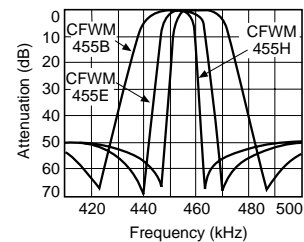

* Available as standard through authorized Murata Electronics Distributors.

* Note: For safety purposes, connect the output of filters to the IF amplifier through a DC blocking capacitor. Avoid applying a direct current to the output of ceramic filters.

PIEZO FILTERS

MULTI-ELEMENT, ULTRA-MINIATURE, RESIN MOLDED, HIGHLY SELECTIVE

CFVM/CFZM 455kHz

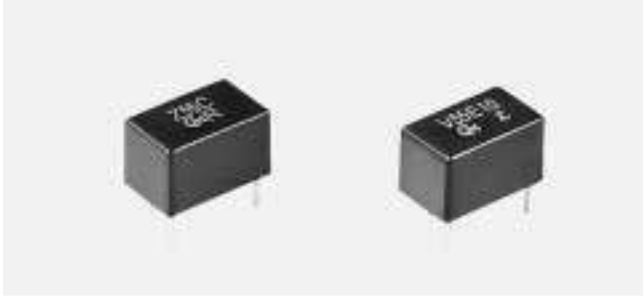

The CFVM 455 line of ceramic filters are 7-element devices connected in ladder form while the CFZM 455 line of filters contain 9-elements. These highly selective filters offer improved stopband attenuation and are recommended for use in a variety of applications. (Also available in 450kHz version.)

SPECIFICATIONS

CFVM 455kHz

| Part Number | Nominal Center Frequency (kHz) | 3dB Bandwidth (kHz) min. | 6dB Bandwidth (kHz) min. | Ripple (dB) max. | 60dB Bandwidth (kHz) max. | Attenuation (dB) min. | Spurious Response (dB) min. | Insertion Loss (dB) max. | Input/Output Impedance (Ohms) |
|-------------|--------------------------------|--------------------------|--------------------------|------------------|---------------------------|-----------------------|-----------------------------|--------------------------|-------------------------------|
| CFVM455B | 455 | ±10 | ±15 | 3 | ±25 | 50 | 25 | 4 | 1000 |
| CFVM455C | 455 | ±9 | ±13 | 3 | ±23 | 50 | 25 | 4 | 1000 |
| CFVM455D | 455 | ±7 | ±10 | 3 | ±20 | 50 | 25 | 4 | 1500 |
| CFVM455E | 455 | ±5.5 | ±8 | 3 | ±16 | 50 | 25 | 6 | 1500 |
| CFVM455E10 | 455 | ±5.0 | ±7.0 | 3 | ±12.5 | 50 | 25 | 6 | 1500 |
| CFVM455F | 455 | ±4.2 | ±6 | 3 | ±12 | 50 | 25 | 6 | 1500 |
| CFVM455G | 455 | — | ±4 | 3 | ±10 | 50 | 25 | 6 | 1500 |
| CFVM455H | 455 | — | ±3 | 3 | ±7.5 | 50 | 25 | 6 | 1500 |

DIMENSIONS: mm

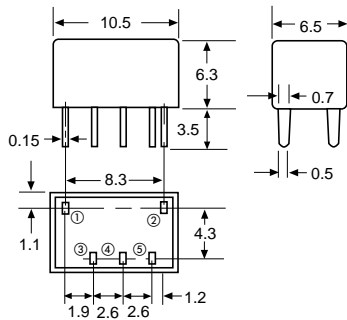

CIRCUIT

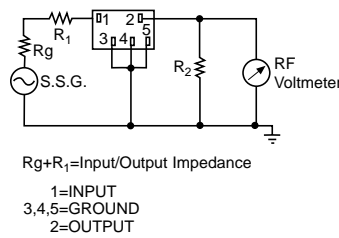

CHARACTERISTICS

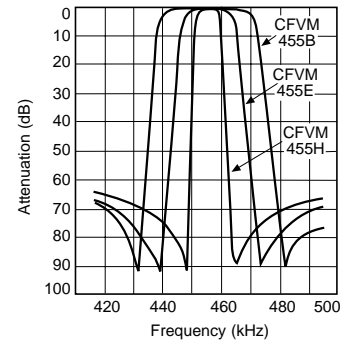

SPECIFICATIONS

CFZM 455kHz

| Part Number | Nominal Center Frequency (kHz) | 3dB Bandwidth (kHz) min. | 6dB Bandwidth (kHz) min. | Ripple (dB) max. | 70dB Bandwidth (kHz) max. | Attenuation (dB) min. | Spurious Response (dB) min. | Insertion Loss (dB) max. | Input/Output Impedance (Ohms) |
|-------------|--------------------------------|--------------------------|--------------------------|------------------|---------------------------|-----------------------|-----------------------------|--------------------------|-------------------------------|
| CFZM455B | 455 | ±10 | ±15 | 3 | ±25 | 70 | 40 | 4 | 1000 |
| CFZM455C | 455 | ±9 | ±13 | 3 | ±23 | 70 | 40 | 4 | 1000 |
| CFZM455D | 455 | ±7 | ±10 | 3 | ±20 | 70 | 40 | 4 | 1500 |
| CFZM455E | 455 | ±5.5 | ±8 | 3 | ±16 | 70 | 40 | 6 | 1500 |
| CFZM455E10 | 455 | ±5.0 | ±7.5 | 3 | ±12.5 | 70 | 40 | 6 | 1500 |
| CFZM455F | 455 | ±4.2 | ±6 | 3 | ±12 | 70 | 50 | 6 | 1500 |
| CFZM455G | 455 | — | ±4 | 3 | ±10 | 70 | 50 | 6 | 1500 |
| CFZM455H | 455 | — | ±3 | 3 | ±7.5 | 70 | 50 | 7 | 1500 |

DIMENSIONS: mm

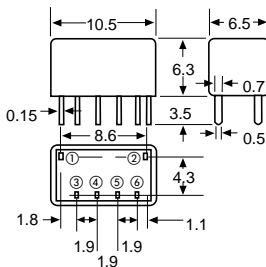

CIRCUIT

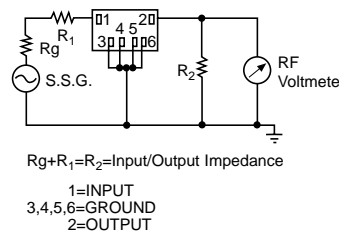

CHARACTERISTICS

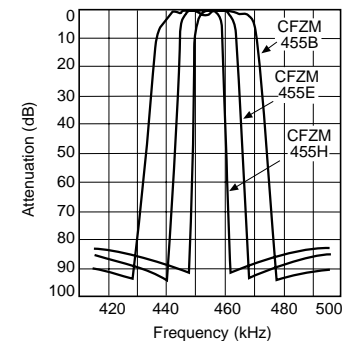

*Note: For safety purposes, connect the output of filters to the IF amplifier through a DC blocking capacitor. Avoid applying a direct current to the output of ceramic filters.

PIEZO FILTERS MULTI-ELEMENT HIGH PERFORMANCE



CFM/CFJ/CFR/CFS/CFL 455kHz

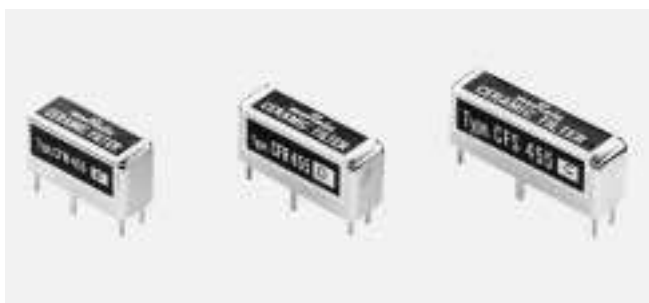

The following lines of filters are high performance devices that achieve ultimate stopband attenuation through the use of multiple piezoelectric elements connected in ladder form. A few of the recommended applications for these filters include high class receivers, SSB communications equipment, pocket pagers and mobile radios.

- CFM 455 9 Ceramic Elements**
- CFJ 455K 11 Ceramic Elements**
- CFR 455 11 Elements Filters**
- CFS 455 15 Element Filters**
- CFL 455 9 Element Filters (GDT Improved)**

(NOT available in 450kHz.)

SPECIFICATIONS

CFM/CFJ/CFR/CFS/CFL 455kHz

| Part Number | Nominal Center Frequency (kHz) | 3dB Bandwidth (kHz) min. | 6dB Bandwidth (kHz) min. | Ripple (dB) max. | Bandwidth | | Attenuation 455±100kHz (dB) min. | Spurious 0.1 ~ 1MHz (dB) min. | Insertion Loss (dB) max. | Input/Output Impedance (Ohms) | Group Delay Time Dev. sec. max. (kHz) |
|-------------|--------------------------------|--------------------------|--------------------------|------------------|-------------|---------|----------------------------------|----------------------------------|--------------------------|-------------------------------|---------------------------------------|
| | | | | | (kHz) max. | At (dB) | | | | | |
| CFM455A | 455 | ±13 | ±17.5 | 3 | ±30 | 60 | 50 | 30 | 3 | 1000 | |
| CFM455B | 455 | ±10 | ±15 | 3 | ±25 | | 50 | 30 | 3 | 1000 | |
| CFM455C | 455 | ±9 | ±13 | 3 | ±23 | | 50 | 30 | 3 | 1000 | |
| CFM455D | 455 | ±7 | ±10 | 3 | ±20 | | 50 | 30 | 3 | 1500 | |
| CFM455E | 455 | ±5.5 | ±8 | 3 | ±16 | | 45 | 30 | 5 | 1500 | |
| CFM455F | 455 | ±4.2 | ±6 | 3 | ±12 | | 45 | 30 | 6 | 2000 | |
| CFM455G | 455 | — | ±4 | 3 | ±10 | | 45 | 30 | 6 | 2000 | |
| CFM455H | 455 | — | ±3 | 3 | ±7.5 | | 45 | 30 | 6 | 2000 | |
| CFM455I | 455 | — | ±2 | 3 | ±5 | | 45 | 30 | 7 | 2000 | |
| CFR455A | 455 | ±13 | ±17.5 | 3 | ±30 | | 70 | 60 | 40 | 4 | 1000 |
| CFR455B | 455 | ±10 | ±15 | 3 | ±25 | 60 | | 40 | 4 | 1000 | |
| CFR455C | 455 | ±9 | ±13 | 3 | ±23 | 60 | | 40 | 4 | 1000 | |
| CFR455D | 455 | ±7 | ±10 | 3 | ±20 | 60 | | 40 | 4 | 1500 | |
| CFR455E | 455 | ±5.5 | ±8 | 3 | ±16 | 55 | | 40 | 6 | 1500 | |
| CFR455F | 455 | ±4.2 | ±6 | 3 | ±12 | 55 | | 40 | 6 | 2000 | |
| CFR455G | 455 | — | ±4 | 3 | ±10 | 55 | | 40 | 6 | 2000 | |
| CFR455H | 455 | — | ±3 | 3 | ±7.5 | 55 | | 40 | 7 | 2000 | |
| CFR455I | 455 | — | ±2 | 3 | ±5 | 55 | | 40 | 8 | 2000 | |
| CFR455J | 455 | — | ±1.5 | 3 | ±4.5 | 55 | | 40 | 8 | 2000 | |
| CFJ455K5 | 455 | — | 2.4 (Total) | 2 | 4.5 (Total) | 60 | — | 60 ^{40 at 600 ~ 700kHz} | 6 | 2000 | |
| CFJ455K14 | 455 | — | ±1.1 ~ ±1.3 | 2 | 4.5 (Total) | | — | 60 ^{40 at 600 ~ 700kHz} | 7 | 2000 | |
| CFJ455K8 | 455 | — | 1.0 (Total) | 1.5 | 3.0 (Total) | | 60 | — | 8 | 2000 | |
| CFS455A | 455 | ±13 | ±17.5 | 3 | ±30 | 80 | 70 | 50 | 4 | 1500 | |
| CFS455B | 455 | ±10 | ±15 | 3 | ±25 | | 70 | 50 | 4 | 1500 | |
| CFS455C | 455 | ±9 | ±13 | 3 | ±23 | | 70 | 50 | 4 | 1500 | |
| CFS455D | 455 | ±7 | ±10 | 3 | ±20 | | 70 | 50 | 4 | 1500 | |
| CFS455E | 455 | ±5.5 | ±8 | 3 | ±15 | | 70 | 50 | 6 | 1500 | |
| CFS455F | 455 | ±4.2 | ±6 | 3 | ±12 | | 70 | 50 | 6 | 2000 | |
| CFS455G | 455 | — | ±4 | 3 | ±9 | | 70 | 50 | 6 | 2000 | |
| CFS455H | 455 | — | ±3 | 3 | ±7.5 | | 70 | 50 | 7 | 2000 | |
| CFS455I | 455 | — | ±2 | 3 | ±5 | | 70 | 50 | 8 | 2000 | |
| CFS455J | 455 | — | ±1.5 | 3 | ±4.5 | | 60 | 50 | 8 | 2000 | |
| CFL455BG5 | 455 | ±10.5 | ±13.5 | 0.5 | ±27.5 | 60 | 60 | 30 | 10 | 1000 | 25μ(455±10.5) |
| CFL455CG1 | 455 | ±9.5 | ±12.0 | 0.5 | ±25.5 | | 60 | 30 | 10 | 1000 | 35μ(455±9.5) |
| CFL455DG2 | 455 | ±7.0 | ±9.0 | 0.5 | ±21.0 | | 60 | 30 | 11 | 1000 | 35μ(455±7) |
| CFL455EG1 | 455 | ±5.0 | ±7.0 | 0.5 | ±18 | | 60 | 30 | 13 | 1500 | 30μ(455±5) |

DIMENSIONS: mm

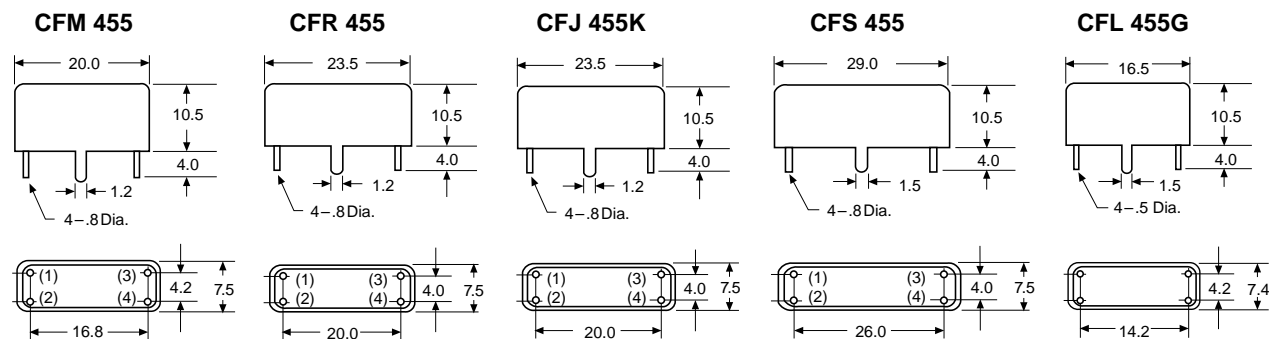

*Note: For safety purposes, connect the output of filters to the IF amplifier through a DC blocking capacitor. Avoid applying a direct current to the output of ceramic filters.

PIEZO FILTERS

MULTI-ELEMENT, RESIN MOLDED, G.D.T. FLAT TYPE

CFWS□Y 455kHz



The CFWS□Y lines of ceramic filters are 6-element devices connected in ladder form. These highly selective filters are designed to address the G.D.T. characteristics required in digital communications. The excellent G.D.T. characteristics allow these filters to be utilized in areas such as the mobile cellular markets as well as a variety of stereo applications. (Also available in 450kHz version.)

SPECIFICATIONS

CFWS□Y 455kHz

| Part Number | 6dB Bandwidth (kHz) min. | 50dB Bandwidth (kHz) min. | Insertion Loss (dB) max. | Attenuation at 455 ± 100kHz (dB) min. | Group Delay Time sec. max. (kHz) | Input/Output Impedance (Ohms) |
|-------------|--------------------------|---------------------------|--------------------------|---------------------------------------|----------------------------------|-------------------------------|
| CFWS455BY | ±15.0 | ±35 | 6.0 | 35 | 30μ (455 ± 10) | 1.5k |
| CFWS455CY | ±12.5 | ±30 | 7.0 | 35 | 30μ (455 ± 8.0) | 1.5k |
| CFWS455DY | ±10.0 | ±25 | 8.0 | 35 | 30μ (455 ± 7.0) | 1.5k |
| CFWS455EY | ±7.5 | ±20 | 9.0 | 35 | 30μ (455 ± 5.0) | 1.5k |
| CFWS455FY | ±6.0 | ±17.5 | 10.0 | 35 | 40μ (455 ± 4.0) | 2.0k |
| CFWS455GY | ±4.5 | ±15 | 13.0 | 35 | 40μ (455 ± 3.0) | 2.0k |

DIMENSIONS: mm

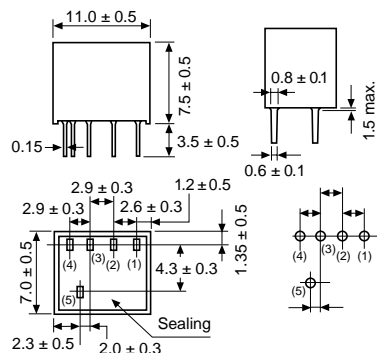

CIRCUIT

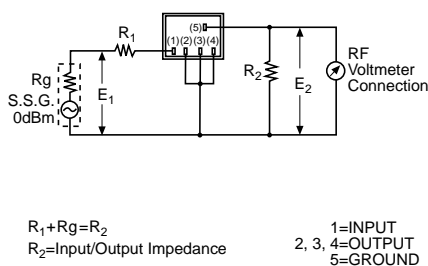

TYPICAL CHARACTERISTICS

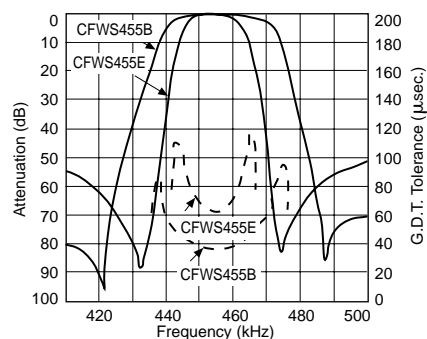

PIEZO FILTERS

PIEZO FILTERS MULTI-ELEMENT, ULTRA MINIATURE G.D.T. FLAT TYPE

CFUM□Y/CFWM□Y 455kHz



The CFUM□Y/CFWM□Y lines of ceramic filters are miniaturized versions of the CFUS□Y/CFWS□Y lines. These ultra-miniature versions consume approximately 40% less volume while still offering the same excellent G.D.T. characteristics as the CFUS□Y/CFWS□Y lines. This reduction in size makes these devices ideal for compact communication applications such as mobile telephones. (Also available in 450kHz version.)

SPECIFICATIONS

CFUM□Y 455kHz

| Part Number | 6dB Bandwidth (kHz) min. | 40dB Bandwidth (kHz) max. | Attenuation at 455 ± 100kHz (dB) min. | Insertion Loss (dB) max. | Group Delay Time sec. max. (kHz) | Input/Output Impedance (Ohms) |
|-------------|--------------------------|---------------------------|---------------------------------------|--------------------------|----------------------------------|-------------------------------|
| CFUM455BY | ±15 | ±35 | 23 | 5 | 15μ (455 ± 10.0) | 1500 |
| CFUM455CY | ±12.5 | ±30 | 23 | 6 | 15μ (455 ± 8.0) | 1500 |
| CFUM455DY | ±10 | ±25 | 23 | 7 | 20μ (455 ± 7.0) | 1500 |
| CFUM455EY | ±7.5 | ±20 | 23 | 8 | 20μ (455 ± 5.0) | 1500 |
| CFUM455FY | ±6.0 | ±17.5 | 23 | 9 | 20μ (455 ± 4.0) | 2000 |
| CFUM455GY | ±4.5 | ±15 | 23 | 10 | 20μ (455 ± 3.0) | 2000 |

- CFUM455□Y is a miniaturized 4-element version of the conventional CFUS455□Y.
- Note: For safety purposes, connect the output of filters to the IF amplifier through a DC blocking capacitor. Avoid applying a direct current to the output of ceramic filters.

DIMENSIONS: mm

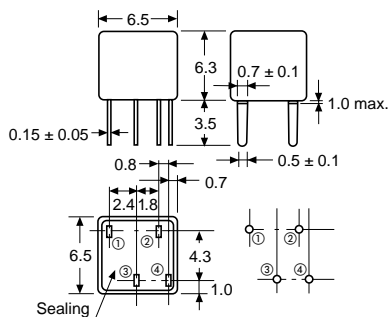

CIRCUIT

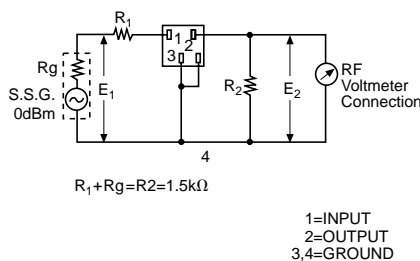

CHARACTERISTICS

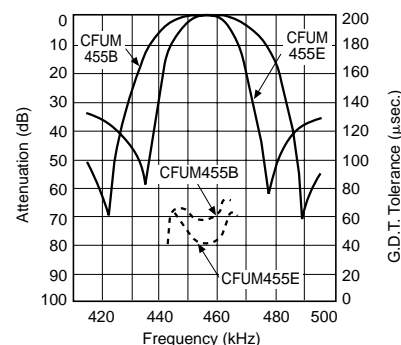

SPECIFICATIONS

CFWM□Y 455kHz

| Part Number | 6dB Bandwidth (kHz) min. | 50dB Bandwidth (kHz) max. | Attenuation at 455 ± 100kHz (dB) min. | Insertion Loss (dB) max. | Group Delay Time sec. max. (kHz) | Input/Output Impedance (Ohms) |
|-------------|--------------------------|---------------------------|---------------------------------------|--------------------------|----------------------------------|-------------------------------|
| CFWM455BY | ±15 | ±35 | 35 | 6 | 30μ (455 ± 10.0) | 1500 |
| CFWM455CY | ±12.5 | ±30 | 35 | 7 | 30μ (455 ± 8.0) | 1500 |
| CFWM455DY | ±10 | ±25 | 35 | 8 | 30μ (455 ± 7.0) | 1500 |
| CFWM455EY | ±7.5 | ±20 | 35 | 9 | 30μ (455 ± 5.0) | 1500 |
| CFWM455FY | ±6.0 | ±17.5 | 35 | 10 | 40μ (455 ± 4.0) | 2000 |
| CFWM455GY | ±4.5 | ±15 | 35 | 13 | 40μ (455 ± 3.0) | 2000 |

- CFWM455□Y is a miniaturized 4-element version of the conventional CFWS455□Y.
- Note: For safety purposes, connect the output of filters to the IF amplifier through a DC blocking capacitor. Avoid applying a direct current to the output of ceramic filters.

DIMENSIONS: mm

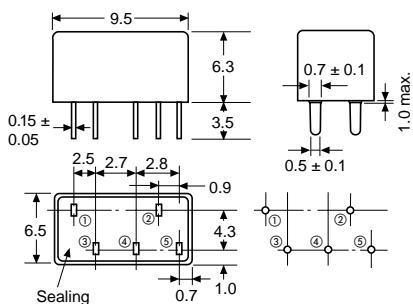

CIRCUIT

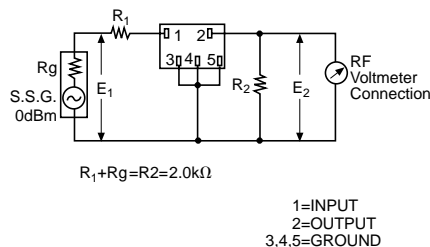

CHARACTERISTICS

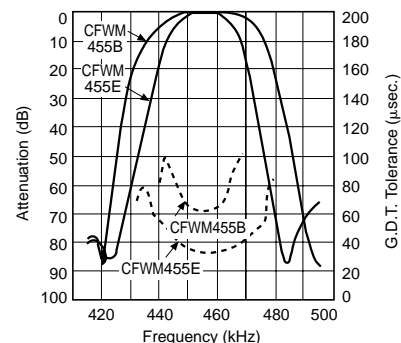

PIEZO FILTERS

SURFACE MOUNTED CHIP PIEZOELECTRIC CERAMICS FILTERS FOR MOBILE COMMUNICATIONS APPLICATIONS

NEW

Murata
Innovator in Electronics

CFUXC 450kHz



Introducing Murata's newest surface mount kHz filter, the CFUXC Series. This is a 4-element filter that uses new technology developed by Murata to achieve the world's smallest and lightest surface mount kHz filter. This 2mm high filter offers the attenuation of a 6-element filter and a good G.D.T. in a smaller package.

SPECIFICATIONS

CFUXC 450kHz

| Part Number | Nominal Center Frequency (kHz) | 3dB Bandwidth (kHz min.) | 6dB Bandwidth (kHz min.) | 50dB Bandwidth (kHz min.) | Spurious Response Attenuation (dB min.) | Insertion Loss (dB max.) | Ripple (dB max.) | G.D.T. Deviation (μsec. max.) | Input/Output Impedance (Ohms) |
|--------------------|--------------------------------|--------------------------|--------------------------|---------------------------|---|--------------------------|------------------|-------------------------------|-------------------------------|
| CFUXC450A100H-TC01 | 450 | — | ±17.5 | ±55 | 40 | 5 | 0.5 | 15 | 2k |
| CFUXC450B100H-TC01 | 450 | — | ±15 | ±50 | 40 | 6 | 0.5 | 15 | 2k |
| CFUXC450C100H-TC01 | 450 | ±9 ~ ±12 | — | ±35 | 40 | 6 | 0.5 | 27 | 2k |

DIMENSIONS: mm

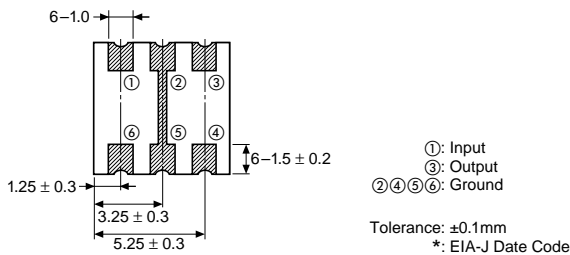
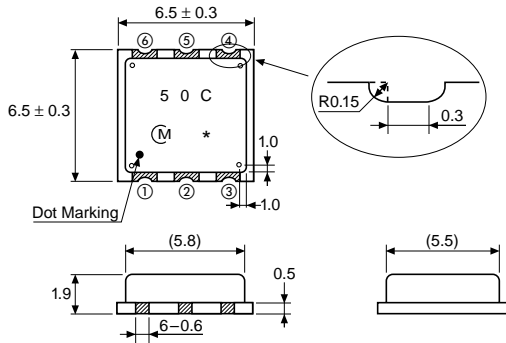

TEST CIRCUIT

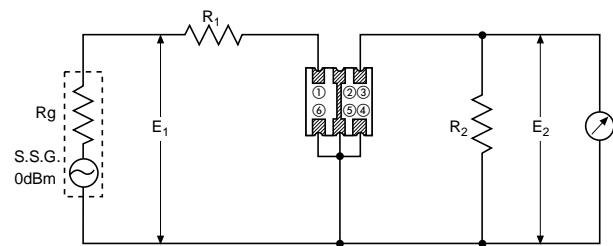

$$R_1 + R_g = R_2 = 2.0k\Omega$$

$$\text{Insertion Loss (dB)} = 20 \cdot \log \left(\frac{E_1}{E_2} \right) - 6 \text{ (dB)}$$

$$= 20 \cdot \log E_1 - 20 \cdot \log E_2 - 6 \text{ (dB)}$$

E_1 : S.S.G. high impedance output

TAPING DIMENSIONS: mm

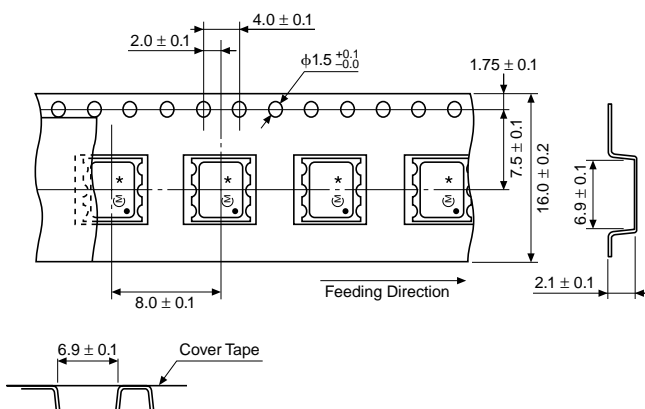

REEL DIMENSIONS: mm

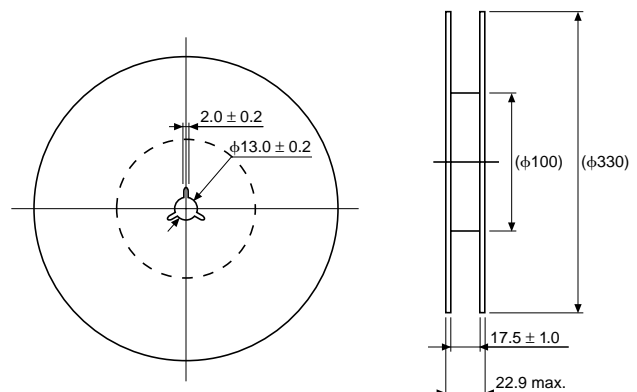

*Note: For safety purposes, connect the output of filters to the IF amplifier through a DC blocking capacitor. Avoid applying a direct current to the output of ceramic filters.

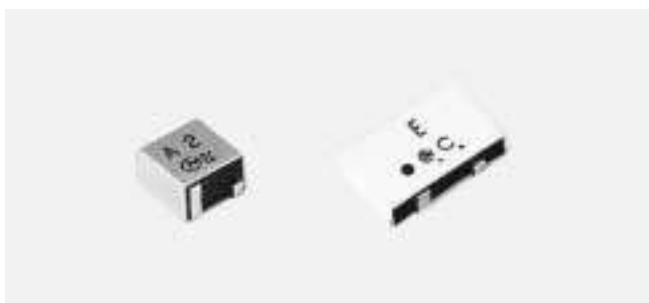

Along with the development of the AM chip filter, IF filters for AM radios have also been made smaller, thinner and in a chip configuration for surface mounting. This is one more example of Murata Electronics' leadership in converting conventional electronic components to chip technology.

PRELIMINARY SPECIFICATIONS

SMD 455kHz

| Part Number | Center Frequency | | Bandwidth (Total) | | | Ripple (max.) | | *Insertion Loss (max.) dB | Stop Band Atten. (min.) at ± 100kHz dB | Group Delay (max.) | | Source And Load Impedance (Ohms) |
|---------------|------------------|--------------|-------------------|------------------|-------------------|---------------|------------------|---------------------------|--|--------------------|------------------|----------------------------------|
| | Nom. (kHz) | Tol. ± (kHz) | 3dB (min.) (kHz) | 6dB (min.) (kHz) | 40dB (max.) (kHz) | dB | Point of Measure | | | μS | Point of Measure | |
| CFUCG455E-TC | 455 | 1.5 | — | 15 | 30 | 1.5 | — | 6 | 27 | — | — | 1500 |
| CFUCG455F-TC | 455 | 1.5 | — | 12 | 25 | 1.5 | — | 6 | 27 | — | — | 1500 |
| CFUCG455G-TC | 455 | 1 | — | 9 | 20 | 1.5 | — | 6 | 25 | — | — | 1500 |
| CFUCG455FX-TC | 455 | 1.5 | — | 12 | 30 | 1 | — | 6 | 27 | 25 | — | 1500 |
| CFUCG455GX-TC | 455 | 1 | — | 9 | 25 | 1 | — | 6 | 25 | 25 | — | 1500 |
| CFUCG455HX-TC | 455 | 1 | — | 6 | 20 | 1 | — | 7 | 25 | 25 | — | 1500 |
| SFGCG455AX-TC | 455 | 2.0 | — | 35 | 80 | 1 | — | 4 | 25 | 15 | — | 1000 |
| SFGCG455BX-TC | 455 | 1.5 | — | 30 | 70 | 1 | — | 5 | 25 | 15 | — | 1000 |
| SFGCG455CX-TC | 455 | 1.5 | — | 25 | 60 | 1 | — | 6 | 25 | 15 | — | 1000 |
| SFGCG455DX-TC | 455 | 1 | — | 20 | 50 | 1 | — | 7 | 23 | 20 | — | 1500 |
| SFGCG455EX-TC | 455 | 1 | — | 15 | 40 | 1 | — | 8 | 23 | 20 | — | 1500 |
| SFPC455E-TC01 | 455 | 1.5 | — | 15 | 30 | — | — | 6 | 27 | — | — | 1500 |
| SFPC455F-TC01 | 455 | 1.5 | — | 12 | 25 | — | — | 6 | 27 | — | — | 1500 |
| SFPC455G-TC01 | 455 | 1 | — | 9 | 20 | — | — | 6 | 25 | — | — | 1500 |
| SFPC455H-TC01 | 455 | 1 | — | 6 | 18 | — | — | 6 | 25 | — | — | 2000 |
| CFWC455CZ-TC | 455 | — | 21 to 26 | — | — | 0.5 | ±10.5 | 6 | 50 | 27 | ±10.5 | 1000 |
| CFWC455CZ2-TC | 455 | — | 18 to 22 | — | — | 0.5 | ±9 | 6 | 50 | 27 | ±9 | 1000 |

DIMENSIONS: mm
CFUCG/SFGCG

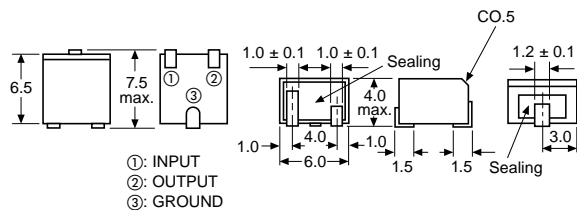

SFPC

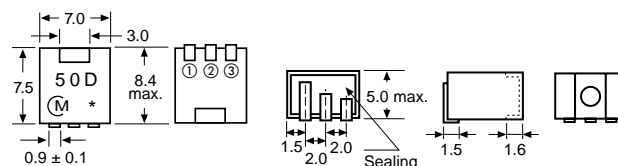

SPECIFICATIONS

CFWC

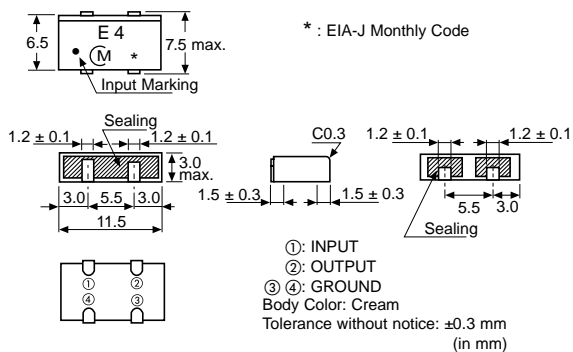

TEST CIRCUIT

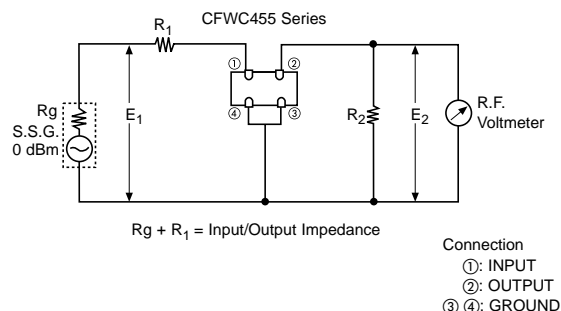

*Note: For safety purposes, connect the output of filters to the IF amplifier through a DC blocking capacitor. Avoid applying a direct current to the output of ceramic filters.

PIEZO FILTERS

SURFACE MOUNTED CHIP PIEZOELECTRIC CERAMIC FILTERS FOR AM APPLICATIONS



SFGCG, SFPC, CFUCG, CFWC 455kHz

CHARACTERISTICS (TYP.)

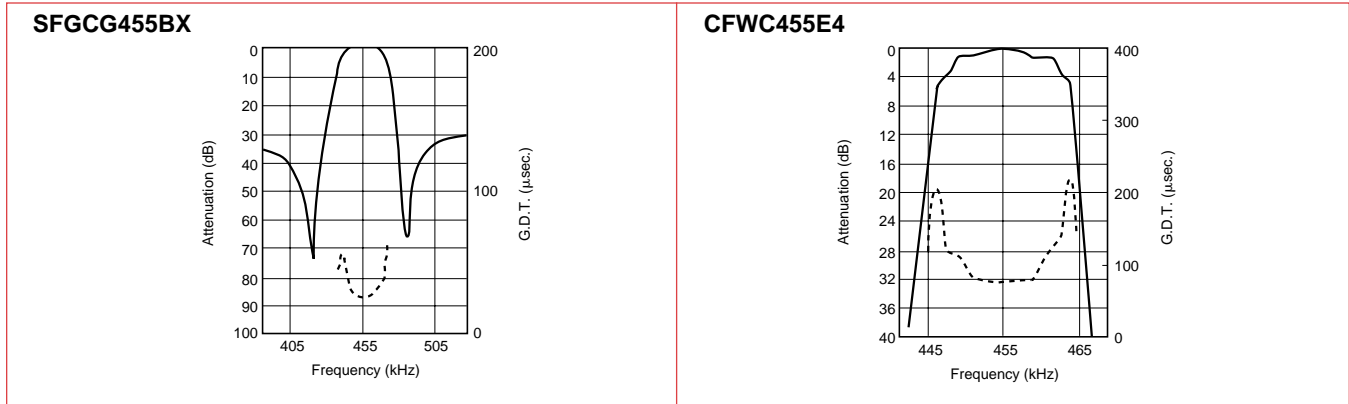

PAD DIMENSIONS: mm

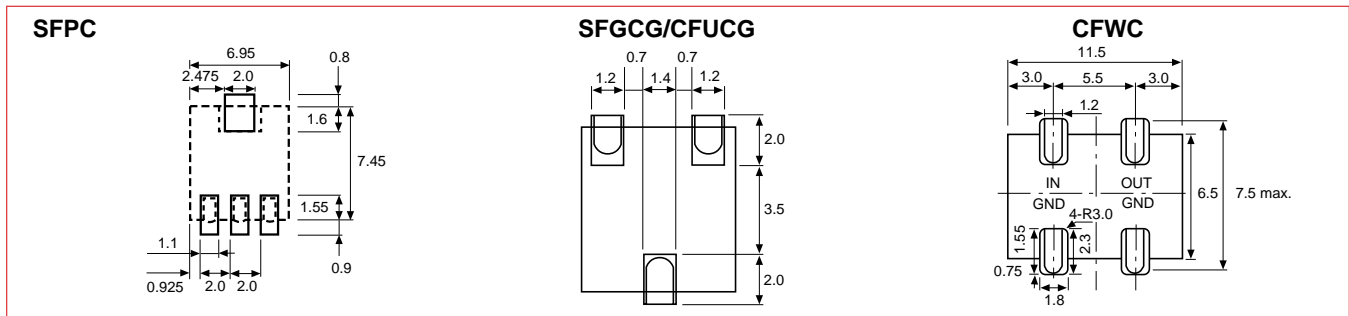

PLASTIC TAPE DIMENSIONS: mm

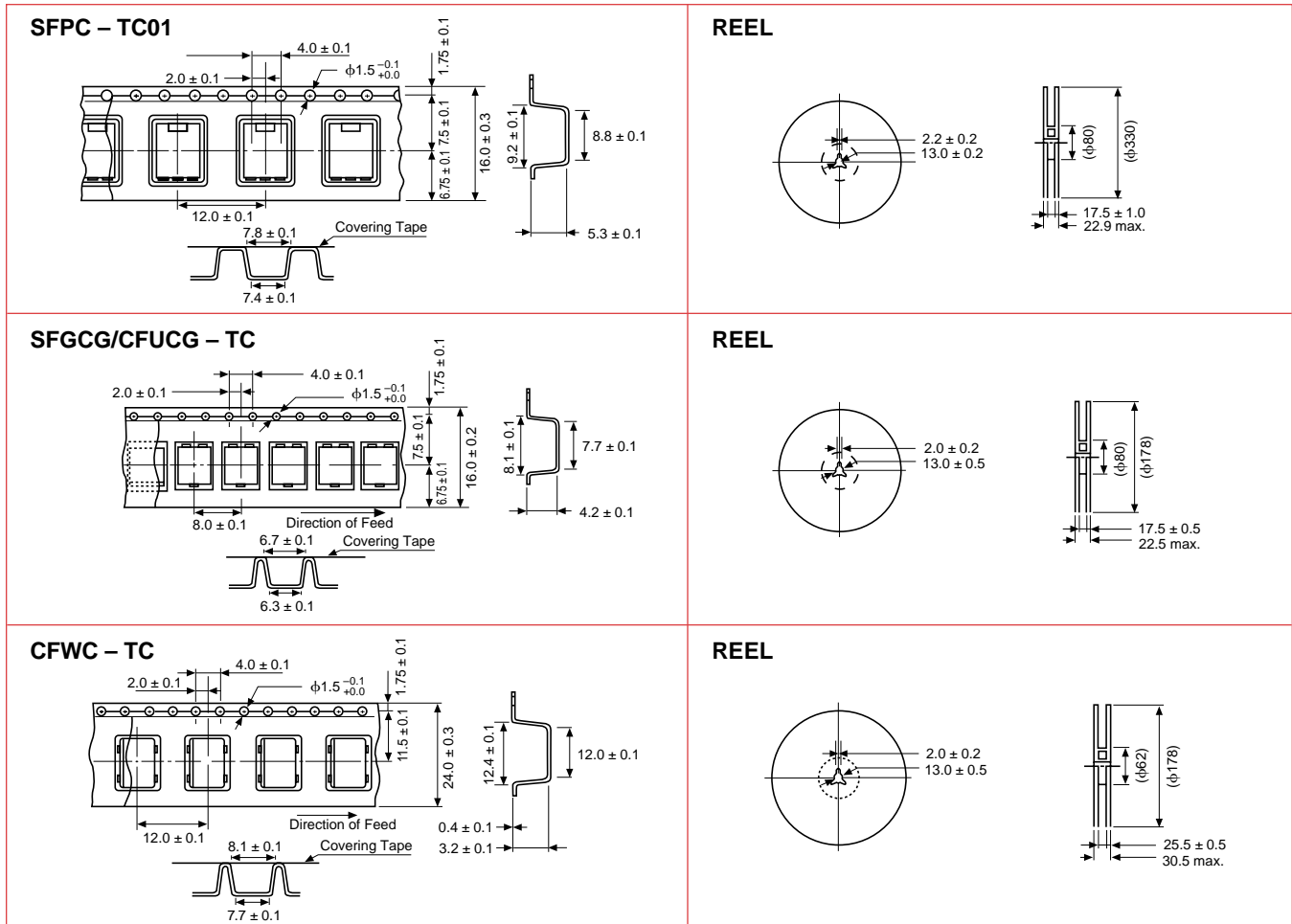

PIEZO FILTERS

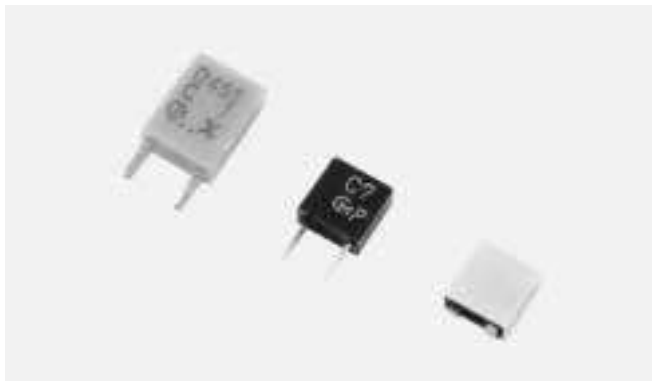

Ceramic discriminator consists of wide band piezoelectric resonator. It is ideal for mobile communication equipment due to its small size and light weight. Standard line includes products for a wide range of applications, from cordless telephones to cellular telephones, making non-adjustment and shrinking of the detection circuit possible.

FEATURES

- Small in size and light weight
- Realize non-adjustment in detection circuit
- High sensitivity and stability
- Wide range of standard products are available for various ICs
- Operating temperature range: -20°C to $+80^{\circ}\text{C}$
Storage temperature range: -40°C to $+85^{\circ}\text{C}$

RECOVERED AUDIO CURVE SPECIFICATIONS**CDB/CDBC/CDBM 455kHz**

| Part Number/ Characteristics | Recovered Audio | | Distortion | | IC | Application |
|---------------------------------|-------------------------------------|-----------------------|---------------------|----------------------|-----------|---|
| | 3dB Bandwidth (from 544kHz) min. | Output (at 455kHz) | (at 455kHz) max. | within 455 ± 8kHz | | |
| CDB455C7 | ±4.0 | 340 ± 60mV | 2.5% | — | MC3357 | Cordless Telephone, Communications Equipment |
| CDBM455C7 | ±4.0 | 340 ± 60mV | 3.0% | — | | |
| CDBC455CX7 | ±4.0 | 350 ± 60mV | 3.0% | — | | |
| CDB455C9 | ±5.0 | 100mV min. | 1.5% | — | NE604N | Cordless Telephone, Cellular Phone, Communications Equipment |
| CDBM455C9 | ±5.0 | 100mV min. | 1.5% | — | | |
| CDBC455CX9 | ±4.0 | 120 ± 40mV | 1.5% | — | | |
| CDB455CL9 | ±15.0 | 70 ± 20mV | 1.5% | 3.5% max. | | |
| CDBM455CL9 | ±15.0 | 70 ± 20mV | 1.5% | 3.5% max. | CXA1003BM | Cellular Phone, Communications Equipment |
| CDB455C13A | ±4.0 | 350 ± 50mV | 3.0% | — | | |
| CDBM455C13A | ±4.0 | 350 ± 50mV | 3.0% | — | | |
| CDBC455CX13 | ±4.0 | 330 ± 50mV | 4.0% | — | | |
| CDB455CL13 | ±15.0 | 110 ± 30mV | 1.5% | 5.0% max. | | |
| CDBM455CL13 | ±15.0 | 110 ± 30mV | 1.5% | 5.0% max. | | |
| CDBC455CLX13 | ±13.0 | 120 ± 30mV | 1.5% | 5.0% max. | MC3372 | Cellular Phone, Cordless Telephone, Communications Equipment |
| CDB455C16 | ±4.0 | 185 ± 40mV | 2.0% | — | | |
| CDBM455C16 | ±4.0 | 185 ± 40mV | 2.0% | — | | |
| CDBC455CX16 | ±4.0 | 175 ± 40mV | 2.0% | — | MC3371 | Cordless Telephone, Communications Equipment |
| CDBM455C18 | ±3.0 | 180 ± 40mV | 2.0% | — | | |
| CDB455C21 | ±4.0 | 55 ± 20mV | 2.0% | — | TA31132 | Cordless Telephone, Cellular Phone, Communications Equipment |
| CDBM455C21 | ±4.0 | 55 ± 20mV | 2.0% | — | | |
| CDBC455CX21 | ±4.0 | 55 ± 20mV | 2.0% | — | | |
| CDB455CL21 | ±13.0 | 65 ± 20mV | 2.5% | 5.0% max. | | |
| CDBM455CL21 | ±13.0 | 65 ± 20mV | 2.5% | 5.0% max. | | |
| CDBC455CLX21 | ±11.0 | 75 ± 25mV | 2.5% | 5.0% max. | | |
| CDB455C24 | ±4.0 | 100 ± 40mV | 2.0% | — | TA31136 | Cordless Telephone, Communications Equipment |
| CDBM455C24 | ±4.0 | 100 ± 40mV | 2.0% | — | | |
| CDBC455CX24 | ±4.0 | 100 ± 40mV | 2.0% | — | | |
| CDB455C27 | ±4.0 | 100 ± 40mV | 2.0% | — | TK10487 | Cordless Telephone, Communications Equipment |
| CDBM455C27 | ±4.0 | 100 ± 40mV | 2.0% | — | | |
| CDBC455CX27 | ±4.0 | 90 ± 30mV | 2.0% | — | | |
| CDB455C28 | ±4.0 | 40 ± 20mV | 3.0% | — | TA31142 | Pager |
| CDBM455C28 | ±4.0 | 40 ± 20mV | 3.0% | — | | |
| CDBC455CX28 | ±4.0 | 40 ± 20mV | 3.0% | — | | |

RECOVERED AUDIO CURVE SPECIFICATIONS

CDB/CDBC/CDBM 455kHz

| Part Number/ Characteristics | Recovered Audio | | Distortion | | IC | Application |
|---------------------------------|-------------------------------------|-----------------------|---------------------|----------------------|-------------------------|--|
| | 3dB Bandwidth (from 455kHz) min. | Output (at 455kHz) | (at 455kHz) max. | within 455 ± 8kHz | | |
| CDB455C29 | ±4.0 | 125 ± 30mV | 2.5% | — | NE605 | Cordless Telephone, Communications Equipment |
| CDBM455C29 | ±4.0 | 125 ± 30mV | 2.5% | — | | |
| CDBC455CX29 | ±4.0 | 100 ± 30mV | 2.5% | — | | |
| CDB455C30 | ±4.0 | 90 ± 30mV | 2.0% | — | TK14501 | Telephone, Communications Equipment |
| CDBM455C30 | ±4.0 | 90 ± 30mV | 2.0% | — | | |
| CDBC455CX30 | ±4.0 | 80 ± 20mV | 2.0% | — | | |
| CDB455C32 | ±4.0 | 40 ± 20mV | 3.0% | — | TA31143 | Pager |
| CDBM455C32 | ±4.0 | 40 ± 20mV | 3.0% | — | | |
| CDBC455CX32 | ±4.0 | 40 ± 20mV | 3.0% | — | | |
| CDB455C34 | ±4.0 | 65 ± 20mV | 2.5% | — | MC13136 | Cordless Telephone, Communications Equipment |
| CDBM455C34 | ±4.0 | 65 ± 20mV | 2.5% | — | | |
| CDB455C35 | ±4.0 | 100 ± 40mV | 2.5% | — | TK10930 | Cordless Telephone, Communications Equipment |
| CDBM455C35 | ±4.0 | 100 ± 40mV | 2.5% | — | | |
| CDBC455CX35 | ±4.0 | 100 ± 40mV | 2.5% | — | | |
| CDBM455C36 | ±3.5 | 100 ± 25mV | 3.5% | — | NE(SA)606, NE(SA)616 | Cordless Telephone, Cellular Phone |
| CDBC455CLX36 | ±13.0 | 90 ± 30mV | 2.5% | 5.0% max. | | |
| CDBM455C39 | ±4.0 | 85 ± 20mV | 2.5% | — | NE(SA)607/617 | Cordless Telephone |
| CDBC455CLX39 | ±11.0 | 130 ± 20mV | 2.5% | 7.0% max. | | |
| CDBM455C40 | ±4.0 | 40 ± 20mV | 3.0% | — | TA31145 | Pager |
| CDBC455CX40 | ±4.0 | 40 ± 20mV | 3.5% | — | | |
| CDB455C42 | ±4.0 | 40 ± 15mV | 3.0% | — | TK14590, TK14591 | Pager |
| CDBM455C42 | ±4.0 | 40 ± 15mV | 3.0% | — | | |
| CDBM455C49 | ±4.0 | 45 ± 10mV | 3.0% | — | MC3361 | Cordless Telephone |
| CDBC455CX49 | ±4.0 | 45 ± 10mV | 3.0% | — | | |
| CDBM455C50 | ±4.0 | 64 ± 6.4mV | 4.0% | — | CXA3117 | Pager |
| CDBC455CX50 | ±4.0 | 64 ± 6.4mV | 4.0% | — | | |
| CDBC455C52 | ±3.0 | 65 ± 25mV | 3.0% | — | SA625 | Communications Equipment |
| CDBC455C55 | ±3.0 | 40 ± 15mV | 3.0% | — | SA608D | Communications Equipment |
| CDBC455C56 | ±4.0 | 100 ± 20mV | 2.0% | — | BA4116FV | Communications Equipment |

IMPEDANCE CURVE SPECIFICATIONS

CDB/CDBC/CDBM 455kHz

| Part Number/ Characteristics | Resonant Frequency (Fr) | Antiresonant Frequency (Fa) | ΔF (Fa-Fr) | Resonant Resistance (R1) | Capacitance (C) | IC | Application |
|---------------------------------|-----------------------------|--------------------------------|-----------------------------|-----------------------------|--------------------|----------|--------------------|
| CDBM455C2 | 447 ± 1.5kHz (Z = 2.05kΩ) | | 463 ± 1.5kHz (Z = 10.0kΩ) | | 140pF ± 20% | TA8104F | Pager |
| CDBC455CX2 | 447 ± 1.5kHz (Z = 0.80kΩ) | | 463 ± 1.5kHz (Z = 3.65kΩ) | | 280pF ± 20% | | |
| CDB455C3 | — | 455 ± 1.5kHz | 48 ± 5.0kHz | 70Ω max. | 600pF ± 20% | CXA1184M | Pager |
| CDBM455C3 | — | 455 ± 1.5kHz | 46 ± 5.0kHz | 70Ω max. | 550pF ± 20% | | |
| CDBM455C4 | — | 470 ± 1.0kHz | 43 ± 2.0kHz | 300Ω max. | 140pF ± 20% | LA8610 | Pager |
| CDB455C10 | 429 ± 2kHz | — | 51 ± 5.0kHz | 70Ω max. | 580pF ± 20% | TA8103F | Cordless Telephone |
| CDBM455C10 | 429 ± 2kHz | — | 51 ± 5.0kHz | 70Ω max. | 580pF ± 20% | | |
| CDBM455C15 | — | 463.5 ± 1kHz | 43 ± 2.0kHz | 300Ω max. | 140pF ± 20% | CXA1183M | Cordless Telephone |
| CDBM455C25 | — | 465 ± 1.5kHz | 45 ± 4.0kHz | 300Ω max. | 135pF ± 20% | CXA1484 | Pager |
| CDBM455C31 | 447 ± 1.5kHz (Z = 2.05kΩ) | | 463 ± 1.5kHz (Z = 10.0kΩ) | | 140pF ± 20% | TA31141 | Pager |
| CDBC455CX31 | 447 ± 1.5kHz (Z = 0.80kΩ) | | 463 ± 1.5kHz (Z = 3.65kΩ) | | 280pF ± 20% | | |
| CDBM455C33 | — | 465 ± 1.5kHz | 45 ± 4.0kHz | 300Ω max. | 135pF ± 20% | CXA1474 | Pager |

DIMENSIONS: mm

CDB455C□/CDB455CL□

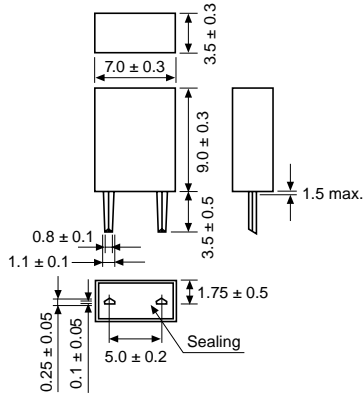

Applicable Part Number: All

CDBM455C□/CDBM455CL□

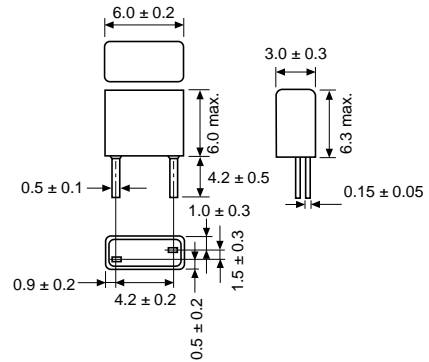

Applicable Part Number: 3, 7, 9, 10, 13, 21, 24, 27, 28, 29, 30, 32, 34, 35, 40, 42, 47, 49, 50

CDBM455C□

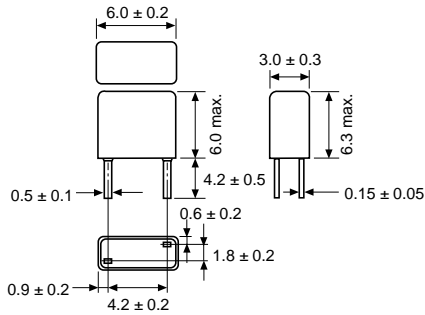

Applicable Part Number: 2, 4, 15, 16, 18, 25, 31, 33, 36, 39

CDBC455CX□/CDBC455CLX□

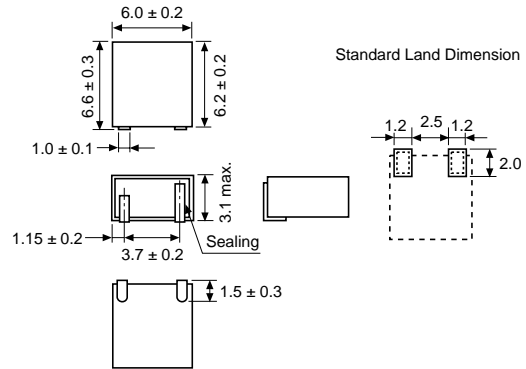

Applicable Part Number: All

PLASTIC TAPE DIMENSIONS: mm

CDBC455C□ – TC

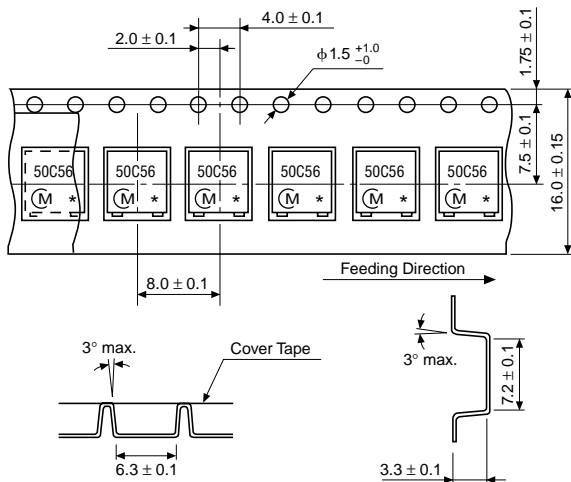

The marked part number is faced on the cover tape side.

Reel

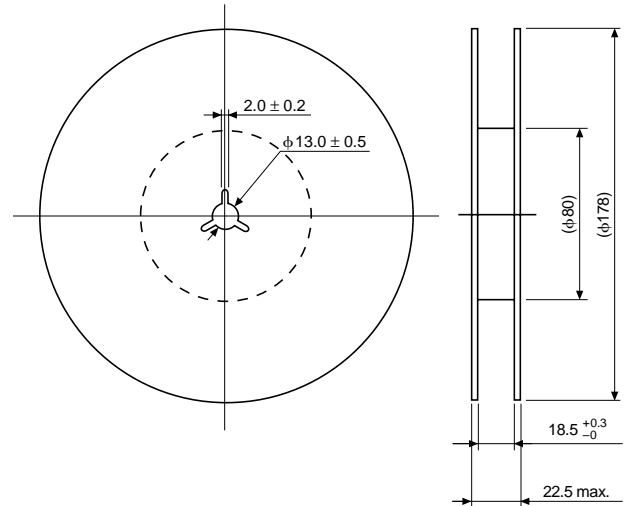

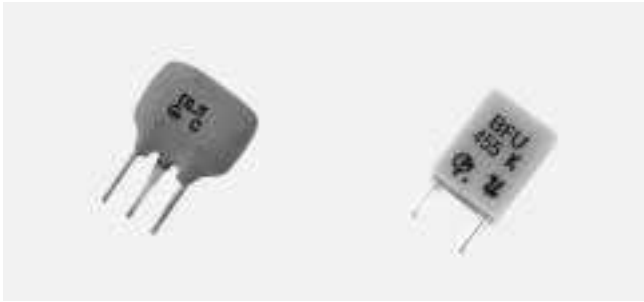

The following filters were specifically designed for signal detection circuitry used in applications such as that found in the search-stop functions of electronically tuned radios.

SPECIFICATIONS

SFE 10.7

| Part Number | Center Freq. (MHz) | 3dB Bandwidth (kHz) | Insertion Loss (dB max.) | Terminal Impedance (Ohms) |
|-------------|--------------------|------------------------------------|--------------------------|---------------------------|
| SFE10.7MFP1 | 10.7 (Nominal) | $F_n \pm 5$ min. $F_n \pm 35$ max. | 6 | 470 |

| DIMENSIONS: mm | CIRCUIT |
|----------------|--|
| | <p>$R_1 + R_g = R_2 = \text{Input/Output Impedance}$ $C = 10\text{pF} \pm 2\text{pF}$ (including stray capacitance and input capacitance of RF Voltmeter.)</p> <p>1=INPUT 2=GROUND 3=OUTPUT</p> |

SPECIFICATIONS

BFU 450/455

| Part Number | Resonant Frequency (kHz) | Resonant Resistance (Ohms) | Δf (fa-fr) (kHz) |
|-------------|--------------------------|----------------------------|--------------------------|
| BFU450K3 | 450 ± 1 | 30 | 27.5 ± 4.5 |
| BFU450C | 450 ± 1 | 20 | 14 ± 2 |
| BFU450C4N | 450 ± 0.8 | 30 | 9 ± 2 |

• Temperature Coefficient is typically 10ppm/°C

| Part Number | Center Frequency (kHz) | 3dB Bandwidth (kHz) | Selectivity |
|-------------|------------------------|---------------------|------------------------------------|
| BFU455K | 455 ± 2 | 8 ± 2 | 8dB @ $f_0 - 9$, 12dB @ $f_0 + 9$ |

| DIMENSIONS: mm | DIMENSIONS: mm | CIRCUIT |
|------------------------------|-----------------------|--|
| <p>BFU450K3/C/C4N</p> | <p>BFU455K</p> | <p>BFU450K3/C/C4N</p> <p>BFU455K</p> |

PIEZO FILTERS

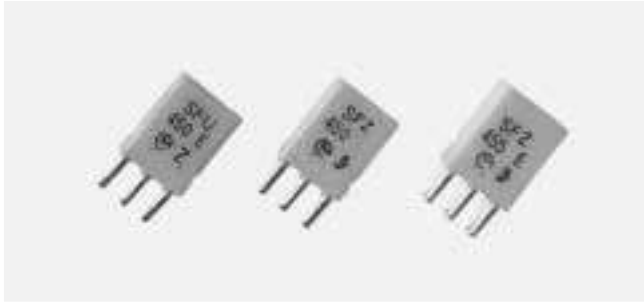

The following filters were designed to address the needs of standard AM filtering requirements. These filters are recommended for use in low cost products where economically, efficient designs are critical.

SPECIFICATIONS

SFU/SFZ/450/455kHz

| Part Number | Center Frequency (kHz) | 3dB Bandwidth (kHz) | Ripple (dB) max. | Selectivity $F_0 \pm 9\text{kHz}$ | Termination Impedance (Ohms) max. | Spurious Response (dB) min. | Insertion Loss (dB) max. | Operating Temperature Range | Withstanding Voltage |
|----------------------------------|------------------------|---------------------|------------------|-----------------------------------|-----------------------------------|-------------------------------|--------------------------|-----------------------------|----------------------|
| *SFU455A | 455 ± 2 | $10 (\pm 3)$ | 0 | 4@-10kHz 6@+10kHz | 3k | 10 (1~3MHz) | 5 | -10°C to +80°C | 50V DC |
| SFU455B (connected to an IFT) | 462 ± 2 | $10 (\pm 3)$ | — | 4@+10kHz 6@-10kHz | 3k | 10 (1~3MHz) | 5 | -10°C to +80°C | |
| SFZ455HL | 455.5 ± 2 | 4.0 ± 1.0 | 1.5 | 23dB min. | 3k | 20 ($F_0 \sim 3\text{MHz}$) | 7.0 | -20°C to +80°C | |
| SFZ455JL | 456 ± 2 | 5.5 ± 1.0 | 1.5 | 18dB min. | 3k | 20 ($F_0 \sim 3\text{MHz}$) | 7.0 | -20°C to +80°C | |
| SFZ450C3N | 450 ± 1 | $2.5 (\pm 1)$ | — | 30@-9kHz 24@+9kHz | 3k | F_0 20 (1~3MHz) | 6.5 | -10°C to +80°C | |

() Typ. value

DIMENSIONS: mm

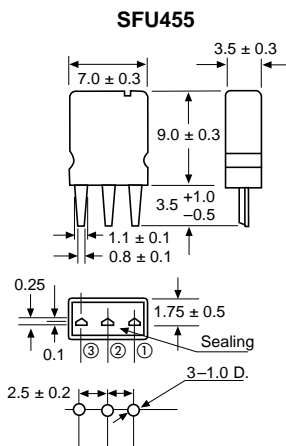

DIMENSIONS: mm

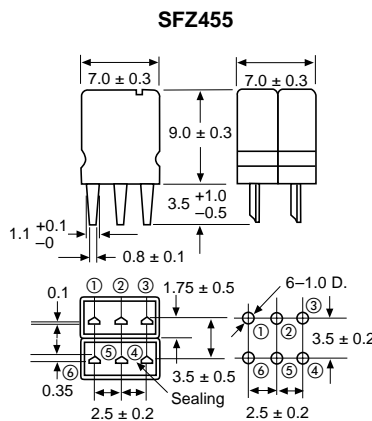

DIMENSIONS: mm

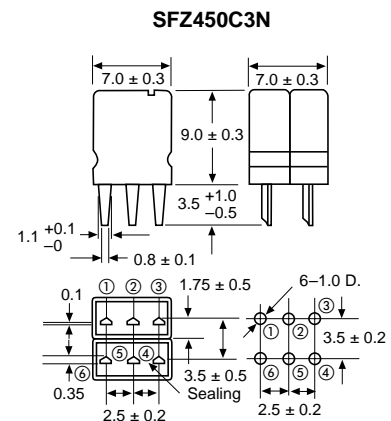

CIRCUIT

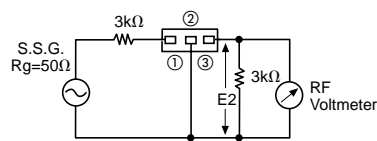

SFU455B is designed to be connected with an I.F.T.

CIRCUIT

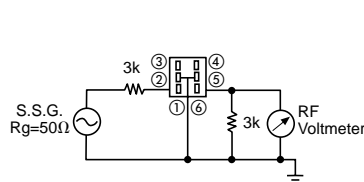

CIRCUIT

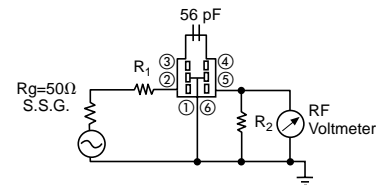

* Available as standard through authorized Murata Electronics Distributors.

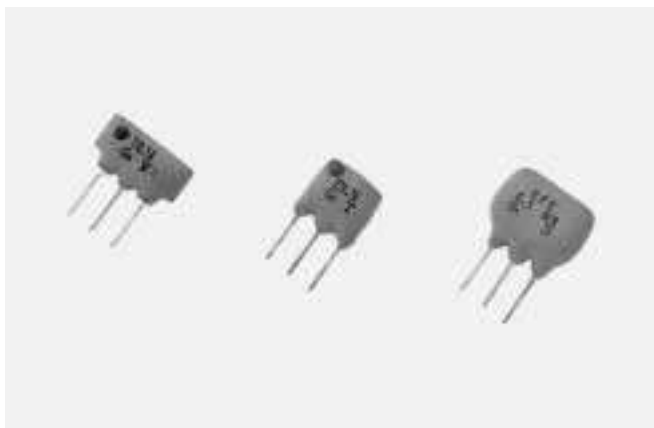

Murata Electronics' MHz series of ceramic filters are monolithic devices which utilize the energy-trapped thickness vibration-mode. This principle of operation is based upon the fact that an excellent resonating element with low spurious vibration can be obtained by adhering to certain theoretical parameters of design. These parameters include the physical dimensions of the ceramic element, the electrode pattern, and the associated mass loading effect of the electrodes.

In addition to employing the principle of energy-trapped thickness shear vibration-mode, Murata also utilizes the theory of the multicoupling mode. In short, this theory utilizes divided electrodes to "trap" different frequencies simultaneously.

The advantages of Murata's multicoupling mode technology is a highly selective, integrated ceramic filter that allows a single ceramic substrate to contain a number of coupled resonators.

Murata categorizes the SFE 10.7 family of ceramic filters according to rank of center frequency. This ranking indicates that a given SFE 10.7 filter will be marked with one of the colors listed in the following chart and will exhibit the center frequency characteristics specified below.

AVAILABLE CENTER FREQUENCY

| Category | Color Code | Center Frequency (MHz) |
|----------|--|------------------------|
| -A | RED (ONLY) | 10.70MHz, ± 30 kHz |
| -Z | RED, BLUE, ORANGE, BLACK OR WHITE* | 10.70MHz, ± 90 kHz |

*Note: Center Frequency Color Code Information—Blue (-B) = 10.67MHz ± 30 kHz, Orange (-C) = 10.73MHz ± 30 kHz, Black (-D) = 10.64MHz ± 30 kHz, White (-E) = 10.76MHz ± 30 kHz

PIEZO FILTERS CERAMIC FILTERS LOW LOSS, HIGHLY SELECTIVE, MINIATURE

SFE MA/MS/MJ/MH 10.7MHz

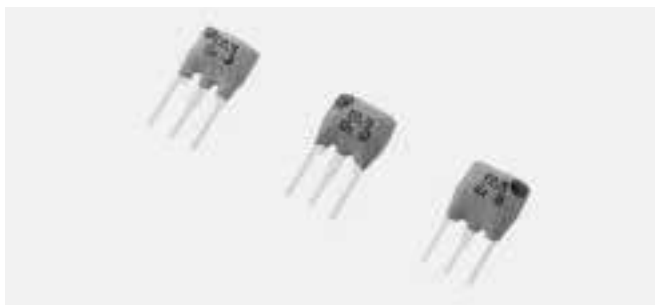

The standard SFE 10.7 line of ceramic filters are extremely reliable devices that exhibit excellent waveform symmetry. These filters have traditionally found wide application in FM receiver technology.

SPECIFICATIONS

SFE MA/MS/MJ/MH 10.7MHz

| | Part Number | 3dB Bandwidth (kHz) | 20dB Bandwidth (kHz) max. | Ripple (dB) max. | Insertion Loss (dB) max. | Spurious (9 ~ 12MHz) (dB) min. |
|--|-----------------|---------------------|---------------------------|------------------|--------------------------|--------------------------------|
| FM-IF | SFE10.7MA5-A | 280 ± 50 | 650 (520) | 1 | 6 (4) | 30 (43) |
| | SFE10.7MS2-A | 230 ± 50 | 600 (420) | 1 | 6 (4) | 40 (45) |
| | SFE10.7MS3-A | 180 ± 40 | 520 (380) | 1 | 7 (4.5) | 40 (45) |
| • Input/output impedance: 330Ω | | | | | | () Typ. value |
| A10 Series | SFE10.7MA5A10-A | 280 ± 50 | 590 (480) | 1 | 2.5 ± 2.0 | 30 (42) |
| | SFE10.7MS2A10-A | 230 ± 50 | 520 (400) | 1 | 3.0 ± 2.0 | 35 (43) |
| | SFE10.7MS3A10-A | 180 ± 40 | 470 (360) | 1 | 3.5 ± 1.5 | 35 (43) |
| | SFE10.7MJA10-A | 150 ± 30 | 360 (290) | 1 | 4.5 ± 2.0 | 35 (44) |
| • Input/output impedance: 330Ω • Low loss and high selectivity. | | | | | | () Typ. value |
| B10 Series | SFE10.7MA5B10-A | 280 ± 50 | 650 | 1 | 3.0 ± 2.0 | 45 |
| | SFE10.7MS2B10-A | 230 ± 50 | 570 | 1 | 3.0 ± 2.0 | 45 |
| | SFE10.7MS3B10-A | 180 ± 40 | 520 | 1 | 5.0 ± 2.0 | 45 |
| • Input/output impedance: 330Ω • High attenuation type | | | | | | () Typ. value |
| C10 Series | SFE10.7MA5C10-A | 280 ± 50 | 650 (540) | 1 | 3.0 ± 2.0 | 30 (47) |
| | SFE10.7MS2C10-A | 230 ± 50 | 570 (470) | 1 | 3.0 ± 2.0 | 40 (48) |
| | SFE10.7MS3C10-A | 180 ± 40 | 470 (360) | 1 | 3.5 ± 2.0 | 35 (45) |
| | SFE10.7MJC10-A | 150 ± 40 | 360 (300) | 1 | 4.5 ± 2.0 | 35 (48) |
| | SFE10.7MHC10-A | 110 ± 30 | 350 (260) | 1 | 7.0 ± 2.0 | 30 (42) |
| • Input/output impedance: 330Ω • Most suitable for a thin type and low profile set. • The performance is the same as that of conventional types. | | | | | | () Typ. value |

| MA5 Series | MA5A10 Series | MA5C10 Series | CIRCUIT |
|-----------------|-----------------|-----------------|---|
| <p>UNIT: mm</p> | <p>UNIT: mm</p> | <p>UNIT: mm</p> | <p> $R_g + R_1 = R_2 = 330\Omega \pm 5\%$ $C = 10\text{pF}$ (including stray capacitance and input capacitance of RF Voltmeter) </p> <p> 1=INPUT 2=GROUND 3=OUTPUT </p> |

FREQUENCY CHARACTERISTICS

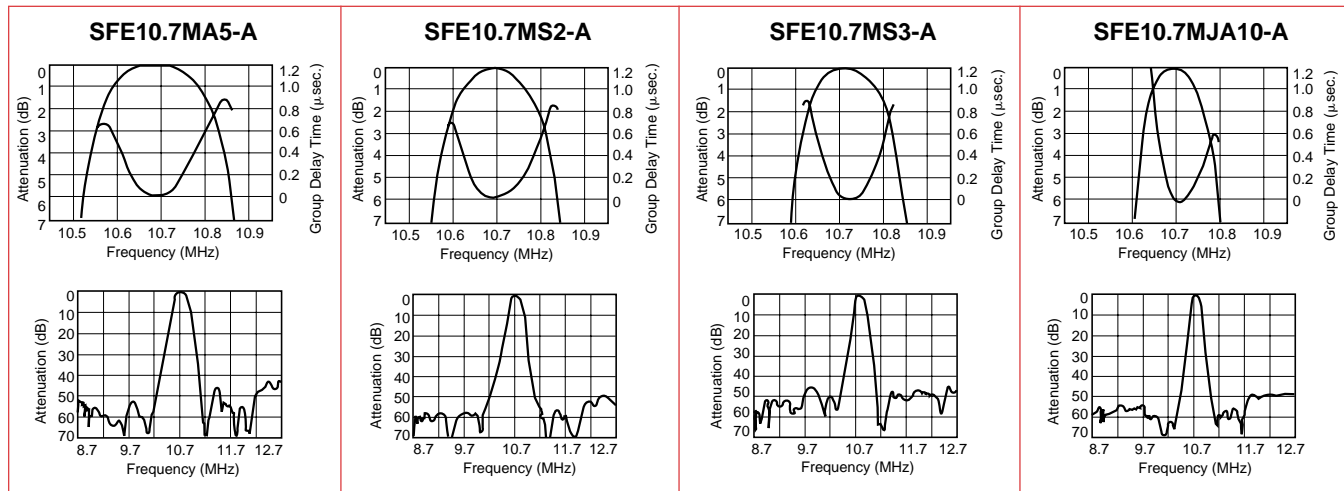

* Available as standard through authorized Murata Electronics Distributors.

PIEZO FILTERS CERAMIC FILTERS HIGHLY SELECTIVE G.D.T. FLAT TYPE

SFE MX/MA8/ML 10.7MHz



The SFE 10.7MX/MA8/ML lines of ceramic filters were designed to minimize the dispersion of amplitude and phase characteristics within the pass band. Because the excellent G.D.T. characteristics of these filters insure signal integrity, they are recommended for use in applications ranging from high grade stereo receivers to digital transmission systems.

SPECIFICATIONS

SFE MX/MA8/ML 10.7MHz

| | Part Number | 3dB Bandwidth (kHz) | 20dB Bandwidth (kHz) max. | Insertion Loss (dB) max. | Spurious (9-12MHz) (dB) min. | Ripple w/n 3dB Bandwidth (dB) | G.D.T. Bandwidth (kHz) min. |
|------------|---------------|---------------------|---------------------------|--------------------------|------------------------------|-------------------------------|-----------------------------|
| MX Series | SFE10.7MX-A | 250 ± 40 | 670 (620) | 12 (10) | 25 (33) | 0 max. | 0.2µ sec. fo ±110kHz |
| | SFE10.7MX2-A | 220 ± 40 | 610 (560) | 12.5 (10.5) | 30 (37) | 0 max. | 0.15µ sec. fo ±80kHz |
| | SFE10.7MZ1-A | 180 ± 30 | 530 (460) | 14 (12.3) | 33 (38) | 0 max. | 0.15µ sec. fo ±60kHz |
| | SFE10.7MZ2-A | 150 ± 30 | 500 (420) | 14 (12.6) | 35 (41) | 0 max. | 0.15µ sec. fo ±50kHz |
| MA8 Series | SFE10.7MA8-A | 280 ± 50 | 650 (520) | 6 (4) | 30 (43) | 0.5 max. | 0.5µ sec. fo ±80 (±100) |
| | SFE10.7MS2G-A | 230 ± 50 | 600 (420) | 7 (4.5) | 40 (45) | 0 max. | 0.5µ sec. fo ±60 (±75) |
| | SFE10.7MS3G-A | 180 ± 40 | 520 (380) | 9 (5) | 40 (45) | 0 max. | 0.5µ sec. fo ±45 (±60) |
| ML Series | SFE10.7ML-A | 280 ± 50 | 650 (610) | 9 (7) | 25 (33) | 0 max. | 0.25µ sec. fo ±70 (±105) |
| | SFE10.7MP3-A | 250 ± 50 | 650 (550) | 10 (8) | 30 (35) | 1.0 max. | 0.25µ sec. fo ±65 (±90) |
| | SFE10.7MM-A | 230 ± 50 | 600 (510) | 11 (9) | 30 (38) | 0 max. | 0.25µ sec. fo ±60 (±85) |

- Input/output impedance: 330Ω
- The rank of center frequency is available in two series: 30kHz steps and 25kHz steps.
- The G.D.T. waveforms of all these types are controlled.

MX Series

⊖ : EIA-J Date Code

MA8 Series

⊖ : EIA-J Date Code

ML Series

⊖ : EIA-J Date Code

CIRCUIT

$R_1 + R_g = R_2 = 330\Omega$
 $C = 10pF$
 (including stray capacitance and input capacitance of RF Voltmeter)

1=INPUT
 2=GROUND
 3=OUTPUT

FREQUENCY CHARACTERISTICS

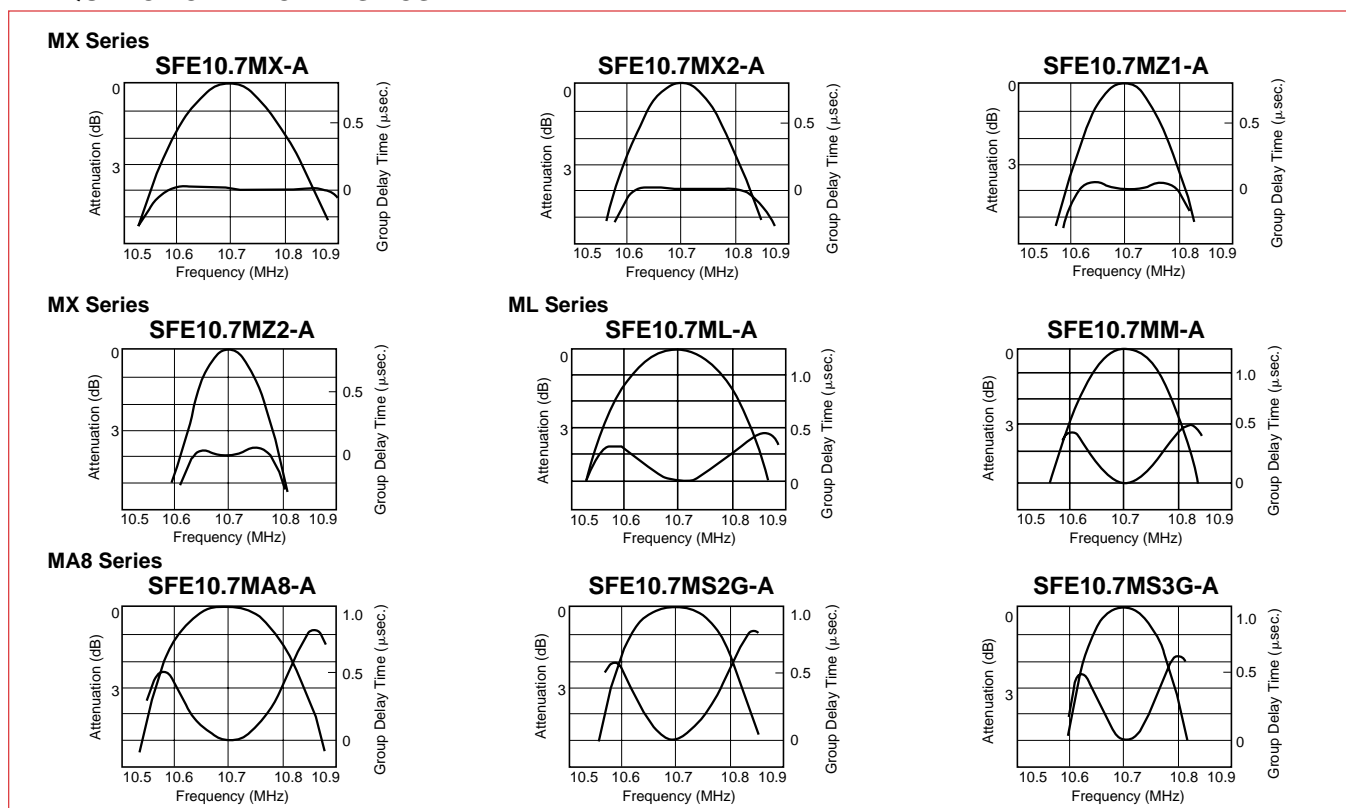

* Available as standard through authorized Murata Electronics Distributors.

PIEZO FILTERS

CERAMIC FILTERS LOW LOSS, WIDE OR NARROW BAND, MINIATURE

SFE MA/MT/MTE/MVE/MFP 10.7MHz

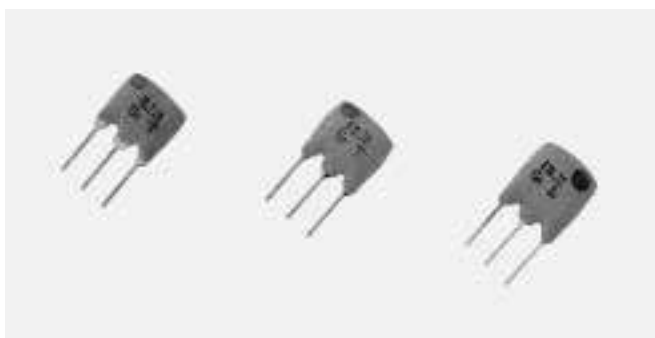

The following filters were developed to offer both narrower and wider bandwidth characteristics for use in products such as DBS receivers. These filters also retain the same reliability that is available with our standard filters. The various bandwidths allow these filters to be utilized in a multitude of new communication applications.

SPECIFICATIONS

SFE MX/MA8/ML 10.7MHz

| | Part Number | 3dB Bandwidth (kHz) | 20dB Bandwidth (kHz) max. | Ripple Within 3dB Bandwidth (dB) | Insertion Loss (dB) max. | Spurious (9 ~ 12MHz) (dB) min. |
|-------------------------|---------------|---------------------|---------------------------|----------------------------------|--------------------------|--------------------------------|
| Wide Bandwidth Series | SFE10.7MA19 | 350 min. (450) | 950 (750) | 3 max. | 3 ± 2 | 20 (30) |
| | SFE10.7MA20-A | 330 ± 50 | 680 (615) | 1 max. | 4 ± 2 | 30 (40) |
| | SFE10.7MA21 | 400 (500) | 950 (750) | 3 max. | 3 ± 2 | 20 (30) |
| | SFE10.7MHY-A | 110 ± 30 | 350 (260) | 1 max. | 7 ± 2 | 30 (42) |
| Narrow Bandwidth Series | SFE10.7MTE | ±25 (82) | 200 (160) | 1 max. | 5.5 ± 2.5 | 30 (48) |
| | SFE10.7MVE | ±13 (56) | 135 (110) | 1 max. | 5.5 ± 2.0 | 30 (41) |
| | SFE10.7MFP | ±20 (36) | 95 (77) | 1 max. | 6.0 (2.5) | 24 (28) |

- Input/output impedance: 330Ω (MA20-A, MHY-A), 470Ω (MA19) () Typ. value
- Center frequency 10.52MHz types of SFE10.7MHY-A is also available.

- Input/output impedance: 330 (MT, MV), 600Ω (MFP) () Typ. value
- Spurious range of SFE10.7MFP: 10.7 ± 1MHz.

| MA19 Series | MTE Series | MVE Series | MFP Series | CIRCUIT |
|-------------------|-------------------|-------------------|-------------------|---|
| | | | | <p> $R_g + R_1 = R_2 = \text{Input/Output Impedance}$ $C = 10\text{pF}$ (including stray capacitance and input capacitance of RF Voltmeter) </p> <p> 1=INPUT 2=GROUND 3=OUTPUT </p> |
| : EIA-J Date Code | : EIA-J Date Code | : EIA-J Date Code | : EIA-J Date Code | |

FREQUENCY CHARACTERISTICS

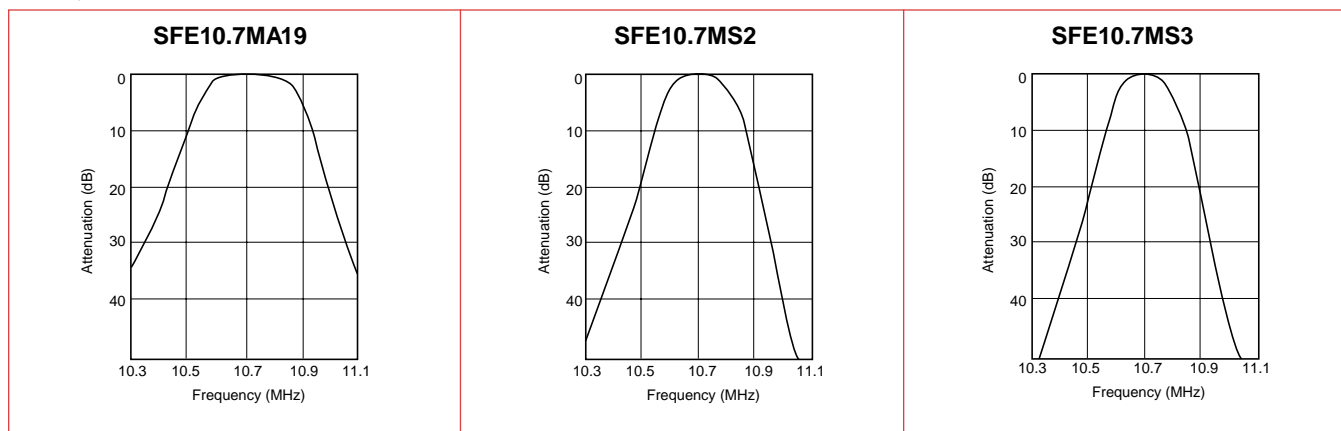

* Available as standard through authorized Murata Electronics Distributors.

PIEZO FILTERS

CERAMIC FILTERS HIGHLY SELECTIVE, 3 ELEMENT TYPE

SFT MA/MS 10.7MHz



The SFT 10.7 ceramic filters are single substrate, 3 element devices that offer 1.5 times more selectivity than the conventional SFE Series of filters. The improved spurious suppression of these filters eliminates the need for cascading multiple filtering devices; therefore, it is possible to design a more compact circuit board configuration.

SPECIFICATIONS

SFT MA/MS 10.7MHz

| Part Number | 3dB Bandwidth (kHz) | 40dB Bandwidth (kHz) max. | Ripple within 3dB Bandwidth (dB) | Insertion Loss (dB) max. | Spurious Attenuation (9 to 12MHz) (dB) min. |
|-------------|---------------------|---------------------------|----------------------------------|--------------------------|---|
| SFT10.7MA5 | 280 ± 50 | 700 (630) | 0.5 max. | 6 ± 2 | 50 (60) |
| SFT10.7MS2 | 230 ± 40 | 650 (580) | 0.5 max. | 6 ± 2 | 50 (60) |
| SFT10.7MS3 | 180 ± 40 | 550 (500) | 0.5 max. | 8 ± 2 | 50 (60) |

- Input/output impedance: 330Ω
- High selectivity is achieved by replacing with SFT10.7 series

() Typ. value

DIMENSIONS: mm

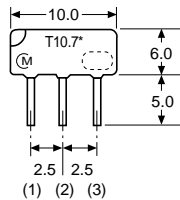

*Varies by part number

CIRCUIT

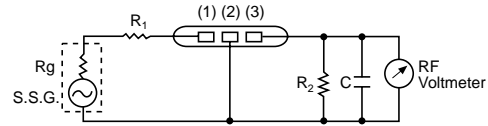

Rg+R1=330Ω
C=10pF
(including stray capacitance and input capacitance of RF Voltmeter.)

1=INPUT
2=GROUND
3=OUTPUT

FREQUENCY CHARACTERISTICS

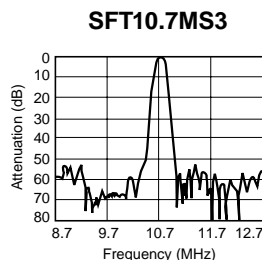
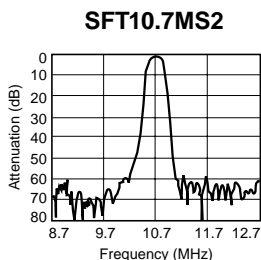
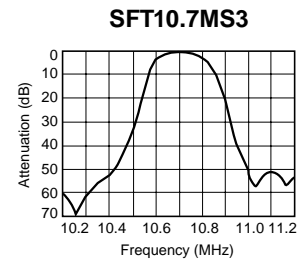
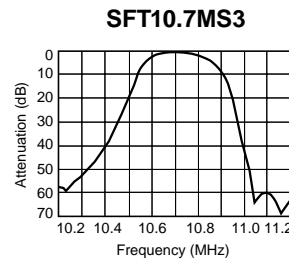
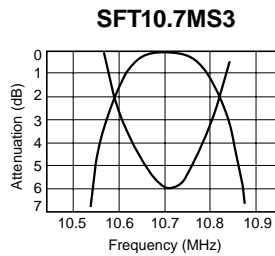
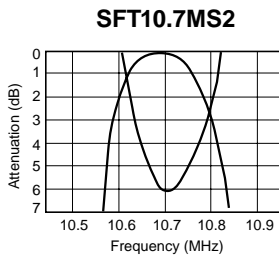

TYPICAL SPURIOUS RESPONSE CHARACTERISTICS SFT10.7MS2

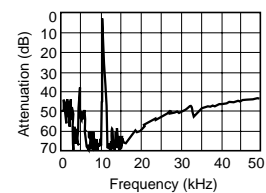

*Available as standard through authorized Murata Electronics Distributors.

PIEZO FILTERS
CERAMIC FILTERS
ULTRA-WIDE BANDWIDTH



KMFC545 10.7MHz



New digital applications are pushing the bandwidth requirements wider on 10.7MHz filters. This matched filter pair is designed to be used in applications that require the widest possible bandwidth at 10.7MHz. These applications can include receivers, audio/video equipment, and measurement equipment.

SPECIFICATIONS

KMFC545 10.7MHz

| Nominal Center Frequency (fn) | 3dB Bandwidth (kHz) min. | 20dB Bandwidth (kHz) max. | Insertion Loss (dB) max. | Ripple within 3dB Bandwidth (dB) | Spurious Response (8 ~ 13MHz) (dB) min. | Withstanding Voltage (DC) | Insulation Resistance (M Ohms) min. |
|-------------------------------|--------------------------|---------------------------|--------------------------|----------------------------------|---|---------------------------|-------------------------------------|
| 10.7MHz | ±325 | 1400 | 6.0 | 2.0 max. | 23 | 50V, 1 min. | 100 (DC 100V) |

• Input/output impedance: 470Ω

DIMENSIONS: mm

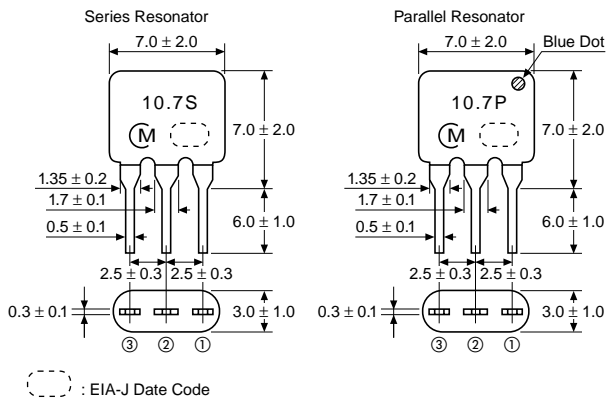

TEST CIRCUIT

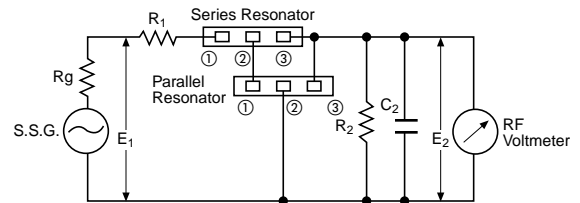

$R_1 = 420\Omega \pm 5\%$; $R_2 = 420\Omega \pm 5\%$; $R_g = 50\Omega$
 $C_2 = 10\text{pF}$ (Including stray capacitance and Input capacitance of RF Voltmeter)

$$\text{Insertion Loss (dB)} = 20 \cdot \log \left(\frac{E_1}{2 \cdot E_2} \right)$$

- ①: INPUT
- ②: GROUND
- ③: OUTPUT

TAPING DIMENSIONS

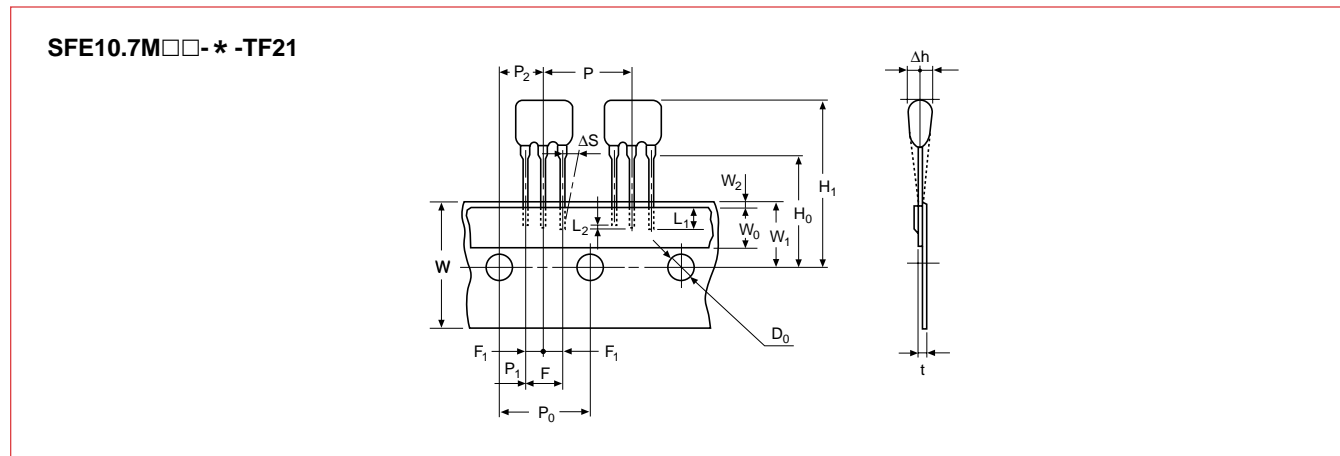

PACKAGING DIMENSIONS: mm

| Item | Code | Dimensions (mm) | Note |
|---|----------------|-------------------------------------|--|
| Adhered Terminal Length | L ₁ | 3 min. | |
| | L ₂ | 2.0 max. | Pay attention to directivity |
| Pitch of Component | P | 12.7 ± 0.5 | |
| Pitch of Sprocket Hole | P ₀ | 12.7 ± 0.2 | |
| Length from Hole Center to Lead | P ₁ | 3.85 ± 0.5 | |
| Length from Hole Center to Component Center | P ₂ | 6.35 ± 0.5 | |
| Lead Spacing (1) | F | 5.0 ^{+0.5} _{-0.2} | |
| Lead Spacing (2) | F ₁ | 2.5 ± 0.2 | |
| Deviation across Tape | Δh | 0 ± 1.0 | |
| Deviation along Tape Left or Right | Δs | 0 ± 1.0 | |
| Carrier Tape Width | W | 18.0 ± 0.5 | |
| Hold-down Tape Width | W ₀ | 6.0 min. | Hold-down tape should not overflow the base tape |
| Position of Sprocket Hole | W ₁ | 9.0 ± 0.5 | |
| Margin between Both Tapes | W ₂ | 0 ^{+1.0} ₋₀ | |
| Lead Distance between Reference and Bottom Planes | H ₀ | 18.0 ± 0.5 | |
| Diameter of Sprocket Hole | D ₀ | φ4.0 ± 0.2 | |
| Total Tape Thickness | t | 0.6 ± 0.2 | |

- When packaged, components of different center frequencies are not mixed.
- Compatible with various automatic insertion.
- Flat pack is the standard package type.

PIEZO FILTERS

PIEZO FILTERS

SURFACE MOUNTED CHIP PIEZOELECTRIC CERAMICS FILTERS FOR AM AND FM APPLICATIONS



SFECV 10.7MHz, CFEC 10.8MHz



Along with the development of the AM chip filter, IF filters for AM/FM radios have also been made smaller, thinner and in a chip configuration for surface mounting. This is one more example of Murata Electronics' leadership in converting conventional electronic components to chip technology.

SPECIFICATIONS

SFECV10.7

| Part Number | Nominal Center Frequency (fn) (MHz)* | 3dB Bandwidth from fn (kHz) | Spurious Attenuation min. | Insertion Loss at fn (dB) max. | Input/Output Impedance (Ohms) |
|--------------------|--------------------------------------|-----------------------------|---------------------------|--------------------------------|-------------------------------|
| SFECV10.7MA21S-TC | 10.7 | 400 min. | 20dB (10.7 to 15.0MHz) | 3.0 ±2.0 | 470 |
| SFECV10.7MA19S-TC | 10.7 | 350 min. | 20dB (10.7 to 15.0MHz) | 3.0 ±2.0 | 470 |
| SFECV10.7MA2S-A-TC | 10.7 | 330 ± 50 | 30dB (9 to 12MHz) | 4.0 ±2.0 | 330 |
| SFECV10.7MA5S-A-TC | 10.7 | 280 ± 50 | 35dB (9 to 12MHz) | 3.0 ±2.0 | 330 |
| SFECV10.7MS2S-A-TC | 10.7 | 230 ± 50 | 35dB (9 to 12MHz) | 3.5 ±2.0 | 330 |
| SFECV10.7MS3S-A-TC | 10.7 | 180 ± 40 | 35dB (9 to 12MHz) | 4.0 ±2.0 | 330 |
| SFECV10.7MJS-A-TC | 10.7 | 150 ± 30 | 35dB (9 to 12MHz) | 5.5 ±2.0 | 330 |
| SFECV10.7MHS-A-TC | 10.7 | 110 ± 30 | 35dB (9 to 12MHz) | 6.0 ±2.0 | 330 |

SFECV10.7 DIMENSIONS: mm

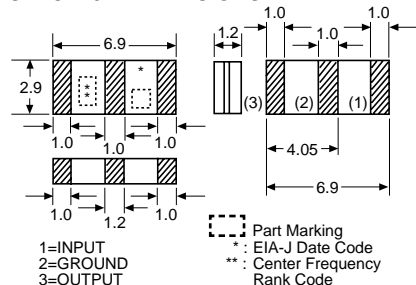

TEST CIRCUIT

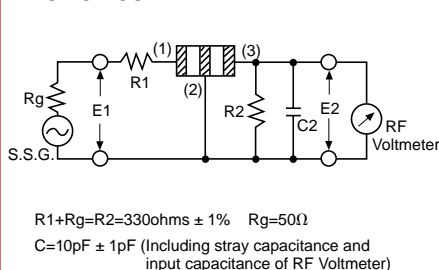

CHARACTERISTICS (Typ.)

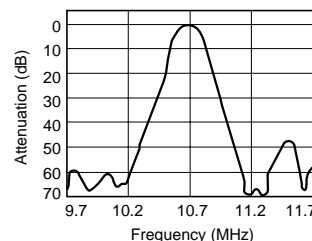

* A: 10.70MHz ± 30kHz Z: 10.70MHz ± 90kHz

Packaging Units: 2000 pcs/reel (180 mmD)

SPECIFICATIONS

CFEC10.8*

| Part Number | Nominal Center Frequency (fn) (MHz) | 3dB Bandwidth from fn (kHz) | 20dB Bandwidth from fn (kHz) max. | Stopband Attenuation fn ± 500kHz (dB) min. | Stopband Attenuation fn ± 1.2kHz (dB) min. | Spurious 9 to 12MHz (dB) min. | Insertion Loss at fn (dB) max. | Ripple (dB) max. | GDT Deviation (μsec) max. | Input/Output Impedance (Ohms) |
|-----------------|-------------------------------------|-----------------------------|-----------------------------------|--|--|-------------------------------|--------------------------------|-------------------|---------------------------|-------------------------------|
| CFEC10.8MK1-TC | 10.8 | ±110 to ±150 | ±310 | 37 | 35 | — | 6 | (fn ± 100kHz) 0.5 | (fn ± 100kHz) 1.5 | 330 |
| CFEC10.8MG1-TC | 10.8 | ±135 to ±180 | ±350 | 32 | 35 | — | 6 | (fn ± 100kHz) 0.5 | (fn ± 100kHz) 1.2 | 330 |
| CFEC10.8ME11-TC | 10.8 | ±150 | ±420 | — | — | 25 | 5 | (fn ± 110kHz) 1 | (fn ± 110kHz) 1.5 | 330 |
| CFEC10.8MD11-TC | 10.8 | ±170 | ±450 | — | — | 25 | 5 | (fn ± 170kHz) 1 | (fn ± 170kHz) 2.0 | 600 |

CFEC10.8 DIMENSIONS: mm

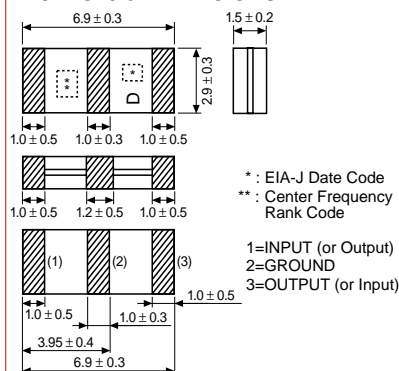

PLASTIC TAPE (for SFECV & CFEC)

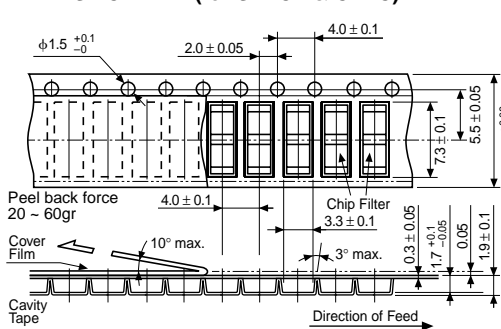

Note: Marked sides face to cover tape. Lead positions are as per above figure. One kind of frequency rank filters are packed in a reel.

PLASTIC REEL

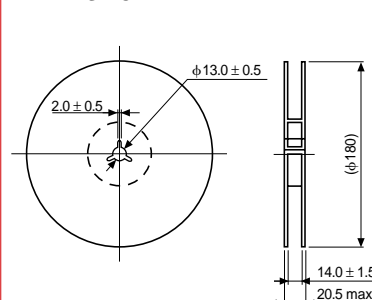

Note: No parts in leader cavity and tail end. 2000 pcs min./reel

* CFEC also available with center frequency of 10.75 or 10.7 MHz.

PIEZO FILTERS CERAMIC DISCRIMINATORS FOR FM RECEIVER



The CDA 10.7 line of ceramic discriminators are resonate devices that offer adjustment free audio detection in both wide and narrow bandwidths. These IC dependent devices utilize FM specific detection methods to convert changes in frequency into an intelligible audio signal.

LEADED CERAMIC DISCRIMINATORS

| Part Number | IC Mfg. | IC Number | Part Number | IC Mfg. | IC Number |
|----------------|------------|-------------------|---------------|------------|-------------------|
| CDA10.7MG1-A | Sony | CX-20029/CX-20111 | CDA10.7MG52-A | Motorola | MC13173 |
| CDA10.7MG2-A | Sony | CX-831 | CDA10.7MG53-A | Matsushita | AN7232 |
| CDA10.7MG4-A | Rohm | BA4234L | CDA10.7MG54-A | Sony | CXA1376AM |
| CDA10.7MG6-A | Toshiba | TA7640AP | CDA10.7MG55-A | Philips | TEA5712T |
| CDA10.7MG7-A | Sanyo | LA1260 | CDA10.7MG56-A | NEC | uPC1391H |
| CDA10.7MG8-A | Toshiba | TA7303P | CDA10.7MG57-A | Toshiba | TA2057 |
| CDA10.7MG9-A | Toshiba | TA7130P | CDA10.7MG58-A | Toshiba | TA2046 |
| CDA10.7MG12-A | Sony | CXA1030P | CDA10.7MG59-A | Samsung | KA2244 |
| CDA10.7MG13-A | Matsushita | AN7007SU | CDA10.7MG60-A | Rohm | BA1448/1449 |
| CDA10.7MG14A-A | Matsushita | AN7006S | CDA10.7MG61-A | Philips | TEA5762 |
| CDA10.7MG15-A | Sanyo | LA1816 | CDA10.7MG62-A | Toko | TK14581 |
| CDA10.7MG16-A | Toshiba | TA8122AN | CDA10.7MG63-A | Samsung | KA2292 |
| CDA10.7MG17-A | Philips | TEA5591 | CDA10.7MG64-A | Samsung | KA2295 |
| CDA10.7MG18-A | Toshiba | TA8132N | CDA10.7MG65-A | Samsung | KA2298 |
| CDA10.7MG19-A | Rohm | BA1440 | CDA10.7MG66-A | Rohm | BA4110 |
| CDA10.7MG20-A | Signetics | NE604 | CDA10.7MG67-A | Rohm | BA4240L |
| CDA10.7MG21-A | Signetics | TBA229-2 | CDA10.7MG68-A | Sony | CXA1991N |
| CDA10.7MG22-A | Sanyo | LA1810 | CDA10.7MG69-A | Sony | CXA1538 |
| CDA10.7MG23-A | Sanyo | LA7770 | CDA10.7MG70-A | Sanyo | LA1150 |
| CDA10.7MG24-A | Philips | TDA2557 | CDA10.7MG71-A | Toshiba | TA7765AF |
| CDA10.7MG25V-A | Telefunken | U829B | CDA10.7MG72-A | Toshiba | TA31161 |
| CDA10.7MG26-A | Sanyo | LA1805 | CDA10.7MG74-A | Sanyo | LA1838 |
| CDA10.7MG27-A | Sony | CXA1238 | CDA10.7MG75-A | Sony | CXA1611 |
| CDA10.7MG28-A | Telefunken | U2501B | CDA10.7MG76-A | Sony | CXA3067M |
| CDA10.7MG29-A | Signetics | TBA120U | CDA10.7MG77-A | Toshiba | TA2111 |
| CDA10.7MG30-A | Philips | TE5592 | CDA10.7MG82-A | Toshiba | TA2099 |
| CDA10.7MG31-A | Toshiba | TA2003 | CDA10.7MG83-A | Sanyo | LA1827 |
| CDA10.7MG32-A | Sony | CXA1343M | CDA10.7MG84-A | Rohm | BH4126FV |
| CDA10.7MG33-A | Toshiba | TA2007 | CDA10.7MG85-A | Philips | SA639 |
| CDA10.7MG34V-A | Telefunken | U4490B | CDA10.7MG86-A | Sanyo | LA1833 |
| CDA10.7MG35-A | Philips | TEA5594 | CDA10.7MG87-A | Motorola | MC3363 |
| CDA10.7MG36-A | Toshiba | TA2029 | CDA10.7MG88-A | Toshiba | TA8721ASN |
| CDA10.7MG37-A | Sanyo | LA1830 | CDA10.7MC1-A | Sony | CX-2009T/CXA1019M |
| CDA10.7MG39-A | Toshiba | TA8186 | CDA10.7MC2-A | Toshiba | TA7687P/F |
| CDA10.7MG40-A | Philips | TEA5710 | CDA10.7MC3-A | Matsushita | AN7220A |
| CDA10.7MG41-A | Rohm | BA4220 | CDA10.7MC4A-A | Motorola | MC3356P |
| CDA10.7MG42-A | Signetics | SA605 | CDA10.7MC5A-A | Sanyo | LA7770 |
| CDA10.7MG43-A | Sanyo | LA1831 | CDA10.7MC6-A | Philips | TEA5591 |
| CDA10.7MG45-A | Toshiba | TA2008 | CDA10.7MC10-A | Philips | TEA5594 |
| CDA10.7MG46-A | Sanyo | LA1832 | CDA10.7MC19-A | Rohm | BA1440 |
| CDA10.7MG47A-A | Signetics | SA626 | CDA10.7MC30-A | Philips | TEA5592 |
| CDA10.7MG48-A | Sanyo | LA1835 | CDA10.7MC40-A | Philips | TEA5710 |
| CDA10.7MG49-A | Motorola | MC13156 | CDA10.7MC43-A | Sanyo | LA1831 |
| CDA10.7MG50-A | Toshiba | TA2022 | CDA10.7MC55-A | Philips | TEA5712T/N2 |
| CDA10.7MG51-A | Siemens | TDA1576T | | | |

Note: The -A suffix designates 10.7MHz center frequency with ± 30 kHz tolerance. The -Z suffix designates a 10.7MHz center frequency with a ± 90 kHz tolerance and is also available. See page 447.

PIEZO FILTERS CERAMIC DISCRIMINATORS FOR FM DEMODULATION RECEIVERS

SURFACE MOUNT CERAMIC DISCRIMINATORS

| Part Number | IC Mfg. | IC Number |
|---------------------|----------|-----------|
| CDACV10.7MC1-A-TC | Sony | CX-20091 |
| CDACV10.7MG1-A-TC | Sony | CX-20029 |
| CDACV10.7MG16F-A-TC | Toshiba | TA8122AF |
| CDACV10.7MG18-A-TC | Toshiba | TA8132F |
| CDACV10.7MC40-A-TC | Philips | TEA5710 |
| CDACV10.7MG50-A-TC | Toshiba | TA2022 |
| CDACV10.7MG51-A-TC | Siemens | TDA1576T |
| CDACV10.7MG53-A-TC | National | AN7232 |
| CDACV10.7MG54-A-TC | Sony | CXA1376 |
| CDACV10.7MG69-A-TC | Sony | CXA1538N |

LEADED DIMENSIONS: mm CDA TYPE

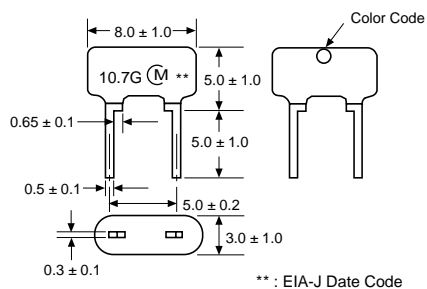

TYPICAL CIRCUIT

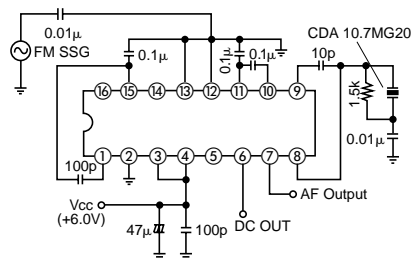

SURFACE MOUNT DIMENSIONS: mm CDACV TYPE

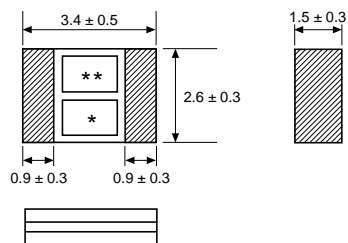

* : EIA-J Date Code
** : Center Frequency Rank Code

RECOMMENDABLE LAND PATTERN: mm

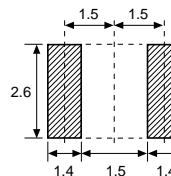

PIEZO FILTERS
 CERAMIC FILTERS
 HIGHLY ACCURATE TV/VCR TYPE

SFSH 4.5–6.5MHz



The SFSH lines of ceramic filters are high quality devices designed to address the TV/VCR/CATV/DBS markets. The SFSH lines are utilized as IF filters in virtually every type of technology currently used in the television industry.

SPECIFICATIONS

SFSH 4.5–6.5MHz

| Part Number | 3dB Bandwidth (kHz) min. | 20dB Bandwidth (kHz) max. | Insertion Loss (dB) max. | Spurious Response (dB) min. | Input/Output Impedance (Ohms) |
|-------------|--------------------------|---------------------------|--------------------------|-----------------------------|-------------------------------|
| SFSH4.5MCB | ±60 (±110) | 600 (470) | 6 (3.2) | 30 (0 ~ 4.5MHz) | 1k |
| SFSH5.5MCB | ±60 (±115) | 600 (500) | 6 (3.6) | 30 (0 ~ 5.5MHz) | 600 |
| SFSH6.0MCB | ±60 (±110) | 600 (500) | 6 (4.0) | 30 (0 ~ 6.0MHz) | 470 |
| SFSH6.5MCB | ±70 (±110) | 650 (530) | 6 (3.6) | 30 (0 ~ 6.5MHz) | 470 |
| SFSH4.5MDB | ±70 (±130) | 750 (520) | 6 (3.0) | 30 (0 ~ 4.5MHz) | 1k |
| SFSH5.5MDB | ±80 (±150) | 750 (640) | 6 (3.0) | 30 (0 ~ 5.5MHz) | 600 |
| SFSH6.0MDB | ±80 (±155) | 750 (630) | 6 (3.8) | 30 (0 ~ 6.0MHz) | 470 |
| SFSH6.5MDB | ±80 (±150) | 800 (640) | 6 (3.4) | 30 (0 ~ 6.5MHz) | 470 |
| SFSH4.5MEB2 | ±125 (±180) | 850 (740) | 6 (3.5) | 25 (0 ~ 4.5MHz) | 1k |

*5.5, 6.0, 6.5MHz types are also available

() Typ. value

DIMENSIONS: mm

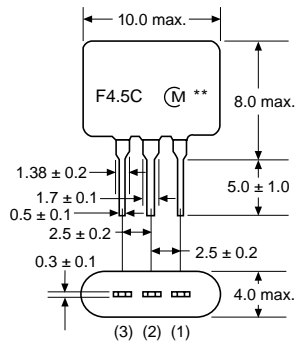

1=INPUT
 2=GROUND
 3=OUTPUT

** : EIA-J Date Code

CIRCUIT

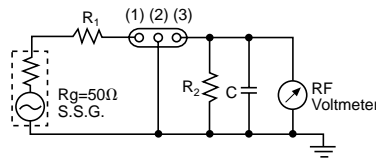

$R_g + R_1 = R_2 =$ Input/Output Impedance
 $C = 10\text{pF}$
 (including stray capacitance and input capacitance of RF Voltmeter)

1=INPUT
 2=GROUND
 3=OUTPUT

CHARACTERISTICS (Typ.)

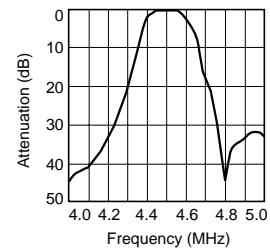

PIEZO FILTERS CERAMIC TRAPS HIGH ATTENUATION

TPS MJ/MB 4.5–6.5MHz



The TPS MJ/MB lines of ceramic traps are band reject filters used for video and sound IF attenuation. The 2 terminal TPS MJ Series can be used to attenuate either the sound signal in B/W receivers or the chroma signal in video. The 3 terminal TPS MB Series contains 2 trap elements on one substrate for additional attenuation. This line of traps can be used in the sound IF of CATV/VCR receivers.

SPECIFICATIONS

TPS MJ 4.5–6.5MHz

| Part Number | Nominal Center Frequency (fn) | Attenuation at fn (dB) min. | 20dB Attenuation Bandwidth (kHz) min. | Spurious Response (0 to fn) (dB) max. |
|-------------|-------------------------------|-----------------------------|---------------------------------------|---------------------------------------|
| ★TPS3.58MJ | 3.58MHz | 20 (27) | 20 (30) | 0.5 (0) |
| TPS4.43MJ | 4.43MHz | 20 (30) | 40 (50) | 0.5 (0) |
| ★TPS4.5MJ | 4.5MHz | 20 (30) | 30 (50) | 0.5 (0) |
| ★TPS5.5MJ | 5.5MHz | 20 (30) | 30 (60) | 0.5 (0) |
| ★TPS6.0MJ | 6.0MHz | 20 (30) | 40 (70) | 0.5 (0) |
| TPS6.5MJ | 6.5MHz | 20 (30) | 40 (90) | 0.5 (0) |

() Typ. value

DIMENSIONS: mm

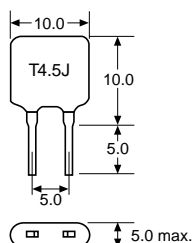

CIRCUIT

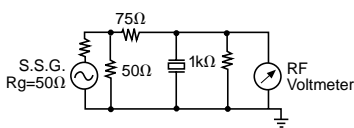

CHARACTERISTICS

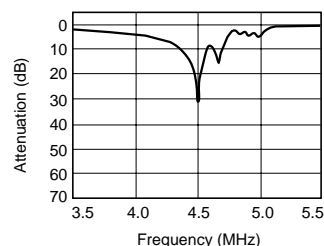

SPECIFICATIONS

TPS MB 4.5–6.5 MHz

| Part Number | Nominal Center Frequency (fn) | Attenuation at fn (dB) min. | 30dB Attenuation Bandwidth (kHz) min. | Spurious Response (0 to fn) (dB) max. |
|-------------|-------------------------------|-----------------------------|---------------------------------------|---------------------------------------|
| ★TPS4.5MB2 | 4.5MHz | 35 (45) | 50 (80) | 0.5 (0) |
| ★TPS5.5MB | 5.5MHz | 35 (45) | 70 (120) | 0.5 (0) |
| ★TPS6.0MB | 6.0MHz | 35 (45) | 70 (120) | 0.5 (0) |
| ★TPS6.5MB | 6.5MHz | 35 (45) | 70 (120) | 0.5 (0) |

The level at 1 MHz shall be made for a reference (0dB)
Other frequencies (3.58, 4.43 MHz) are also available.

() Typ. value

DIMENSIONS: mm

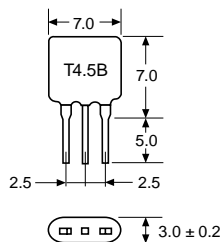

CIRCUIT

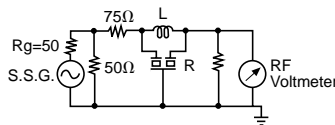

| | L | R |
|-------|-------|-------|
| MB2 | 8.2μH | 2.2kΩ |
| Other | 15μH | 1.0kΩ |

CHARACTERISTICS

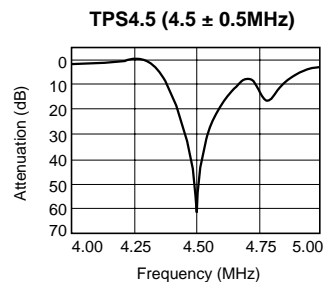

★ Available as standard through authorized Murata Electronics Distributors.

PIEZO FILTERS CERAMIC DISCRIMINATORS FOR QUADRATURE DETECTION

CDA MC/ME 4.5–6.5MHz



The CDA MC/ME lines of ceramic discriminators are IC dependent devices used in the recovery of audio signals. The CDA MC discriminators have three terminals while the CDA ME discriminators are 2 terminal devices.

MATCHING IC

CDA MC 4.5–6.5MHz

| Part Number | IC | Part Number | IC | Part Number | IC |
|-------------|----------|-------------|------------|-------------|----------|
| CDA□MC10 | TBA120T | CDA□MC22 | M51354AP | CDA□MC30 | M51348FP |
| CDA□MC15 | TA7146P | CDA□MC23 | M51316P | CDA□MC31 | TDA4282T |
| CDA□MC16 | TDA4940 | CDA□MC24B | LA7520 | CDA□MC32 | LA7522 |
| CDA□MC17 | TDA4280 | CDA□MC25 | LA7521 | CDA□MC33 | μPC1416G |
| CDA□MC18 | HA11229 | CDA□MC26 | LA7530 (N) | CDA□MC34 | TBA130-2 |
| CDA□MC19 | μPC1391H | CDA□MC27 | μPC1411CA | CDA□MC35 | M51345FP |
| CDA□MC20 | μPC1382C | CDA□MC28 | M51316BP | | |
| CDA□MC21 | μPC1383C | CDA□MC29 | M51365SP | | |

□ Indicates frequency 4.5, 5.5, 5.74, 6.0, 6.5 MHz are available. Note that part numbers, circuits and ratings vary according to the IC used at detector process.

DIMENSIONS: mm

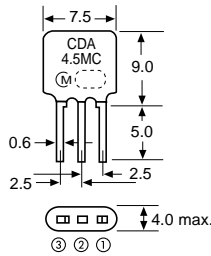

⊖ : EIA-J Date Code

CIRCUIT

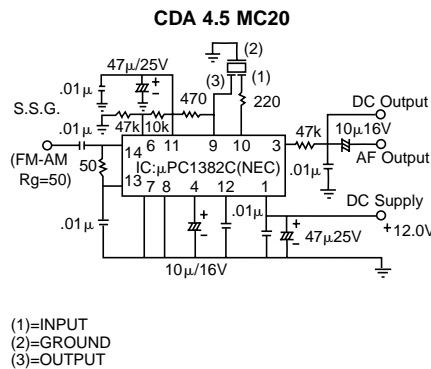

RECOVERED AUDIO CHARACTERISTICS

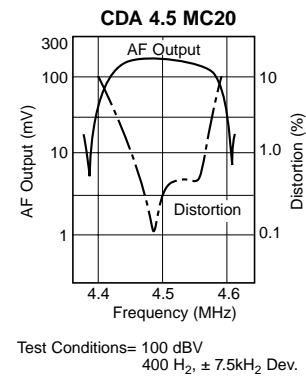

MATCHING IC

CDA ME 4.5–6.5MHz

| Part Number | IC | Part Number | IC | Part Number | IC |
|-------------|----------|-------------|----------|-------------|-----------|
| CDA□ME1 | CX-20014 | CDA□ME8 | TBA129 | CDA□ME23 | M51496P |
| CDA□ME2 | AN5135 | CDA□ME10 | TDA2546A | CDA□ME27 | LA7650 |
| CDA□ME3 | TA7678AP | CDA□ME19 | M51346BP | CDA□ME30 | CXA1110AS |
| CDA□ME5 | AN5135NK | CDA□ME20 | LA7550 | CDA□ME34 | TA8680N |
| CDA□ME6 | M51346AP | CDA□ME21 | LA7545 | CDA□ME35 | LA7680 |
| CDA□ME7 | TDA4503 | CDA□ME22 | TDA2556 | CDA□ME37 | TA8691N |

□ Indicates frequency 4.5, 5.5, 5.74, 6.0, 6.5 MHz are available. Note that part numbers, circuits and ratings vary according to the IC used at detector process.

DIMENSIONS: mm

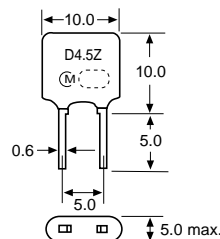

⊖ : EIA-J Date Code

CIRCUIT

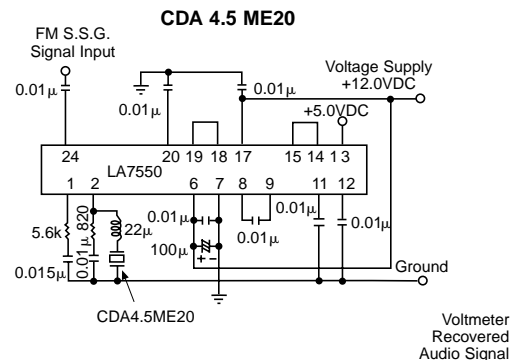

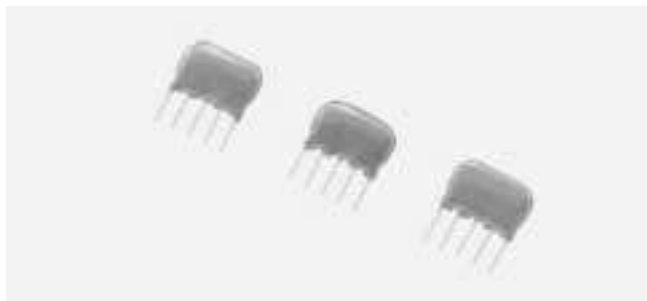

This series of saw filters is designed for TV/VCR applications. These filters are capable of passing 1) SIF and PIF, 2) SIF or 3) PIF. Saw filters are made up of zinc oxide on a glass substrate. Murata provides saw filters for a variety of television standards worldwide.

SPECIFICATIONS

SAF MHz

| Part Number | Insertion Loss (dB) max. | Picture Carrier (dB) max. | Chroma Carrier (dB) min. | Attenuation (dB) max. at fs-0.3MHz | Attenuation (dB) max. at fs+0.3MHz | Adjacent Sound Carrier (dB) min. | Adjacent Picture Carrier (dB) min. | Spurious Response (dB) min. | Spurious Response (dB) min. | Temperature Coefficient (ppm/°C) |
|---------------|--------------------------|---------------------------|--------------------------|------------------------------------|------------------------------------|----------------------------------|------------------------------------|------------------------------|---------------------------------------|----------------------------------|
| SAF54MC200Z | 16(13) | 40 min. | 17 | 3 | 3 | 40 | 37 | 28 (0~52.75MHz) | 30 (56.75~70MHz) | -28 ± 20 |
| SAF41MC200Z | 17(14) | 40 min. | 17 | 3 | 3 | 40 | 37 | 28 (0~39.75MHz) | 30 (43.75~56MHz) | -28 ± 20 |
| SAF39.2MC70Z | 19(14) | 40 min. | 35 | 6 | 6 | 40 | 30 | 30 (28~31.2MHz) | 30 (40.7~45MHz) | -10 ± 20 |
| SAF33.4MC200Z | 20(18) | 40 min. | 20 | 4 | 4 | 40 | 35 | 30 (0~31.9MHz) | 30 (40.4~47MHz) | -10 ± 20 |
| SAF54MD200Z | 20(17) | within ±3 | 20 | fs~0.2MHz 3 | fs~0.2MHz 3 | 35 | 30 | 30 (0~70MHz) | 15 ¹ (55.5~57.5MHz) | -28 ± 20 |
| SAF41MD200Z | 17(14) | within ±3 | 20 | fs~0.2MHz 3 | fs~0.2MHz 3 | 35 | 35 | 30 (0~55MHz) | 15 ¹ (42.5~44.5MHz) | -28 ± 20 |
| SAF33.4MD200Z | 20.5(16) | within ±3 | 20 | fs~0.2MHz 3 | fs~0.2MHz 3 | 35 | 35 | 30 (0~50MHz) | 15 ¹ (34.67~37.7MHz) | -10 ± 20 |
| SAF33.0MDA70Z | 26(23) | 5.0 ± 3.0 | 12 | fs~0.2MHz 3 | fs~0.2MHz 3 | 26 | 20 | 15 (0~39.5MHz) | 8 ¹ (34.67~37.7MHz) | -10 ± 20 |
| SAF32.9MDE70Z | 25(23) | 4.3 ± 3.0 | 15 | fs~0.2MHz 3 | fs~0.2MHz 3 | 35 | 25 | 22 (0~31.5MHz) | 10 ¹ (35.27~38MHz) | -10 ± 20 |
| SAF31.4MD70Z | 28(26) | within ±3 | 15 | fs~0.2MHz 3 | fs~0.2MHz 3 | 35 | 35 | 30 ¹ (0~45MHz) | 15 ¹ (32.645~35.675MHz) | -10 ± 20 |

DIMENSIONS: mm

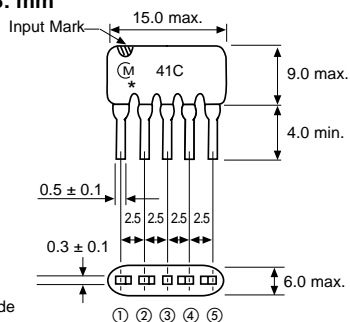

SAF-200Z

DIMENSIONS: mm

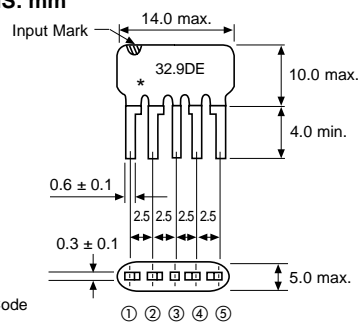

SAF-70Z

- SAF54MC200Z, SAF41MC200Z and SAF33.4MC200Z are for Split Carrier System.
- SAF54MD200Z, SAF41MD200Z, SAF33.4MD200Z and SAF31.4MD70Z are for Quasi-Parallel System.

- SAF33.0MDA70Z is for Multi-Sound TV in Northern Europe. (): Typ. values
- SAF32.9MDE70Z is for Multi-Sound TV in U.K.
- 0dB level should be at fs.

¹Minimum attenuation between picture carrier and sound carrier

FREQUENCY CHARACTERISTICS

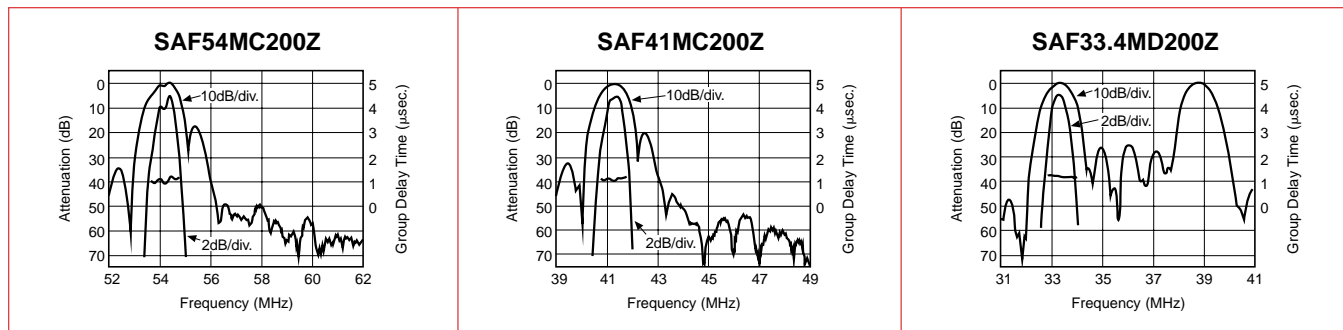

PIEZO FILTERS

SAW FILTERS FOR AUDIO VISUAL EQUIPMENT

MULTI TV/VCR SIF



SAF Series

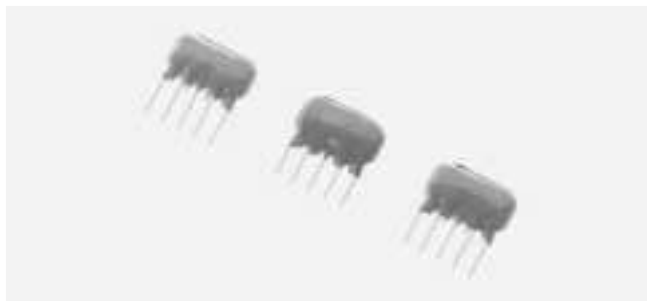

This series of saw filters is designed for TV/VCR applications. These filters are capable of passing 1) SIF and PIF, 2) SIF or 3) PIF. Saw filters are made up of zinc oxide on a glass substrate. Murata provides saw filters for a variety of television standards worldwide.

SPECIFICATIONS

SAF

| Part Number | Insertion Loss (dB) max. | Picture Carrier (dB) max. | Chroma Carrier (dB) min. | Attenuation (dB) max. at fs-0.3MHz | Sound 1 (fs1) Carrier (dB) max. | Sound 2 (fs2) Carrier (dB) max. | Attenuation (dB) max. at fs+0.3MHz | Adjacent Sound Carrier (dB) min. | Adjacent Picture Carrier (dB) min. | Spurious Response (dB) min. | Spurious Response (dB) min. | Temperature Coefficient (ppm/°C) |
|----------------|--------------------------|---------------------------|--------------------------|------------------------------------|---------------------------------|---------------------------------|------------------------------------|----------------------------------|------------------------------------|-----------------------------|-----------------------------|----------------------------------|
| SAF32.0MCA70Z | 26(23) | 35(55) | 25(35) | 6 | 3 | 3 | 6 | 40(55) | 35(50) | 30 (0~30MHz) | 22 (33.57~42MHz) | -10 ± 20 |
| SAF32.9MCA70Z | 25(22) | 35(53) | 25(34) | 6 | 3 | 3 | 6 | 40(55) | 35(43) | 30 (0~30.9MHz) | 22 (34.47~42MHz) | -10 ± 20 |
| SAF33.4MCB200Z | 29(26) | 30(47) | 14(30) | 6 | 3 | 3 | 6 | 30(46) | 35(50) | 25 (0~30.9MHz) | 25 (40.4~46.0MHz) | -10 ± 20 |
| SAF33.4MCD70Z | 29(26) | 30(49) | 20(37) | 2 [32.348 MHz] | 2 | 2.5 | 8 | 30(50) | 28(42) | 25 (0~30.9MHz) | 30 (40.4~46.0MHz) | -10 ± 20 |

DIMENSIONS: mm

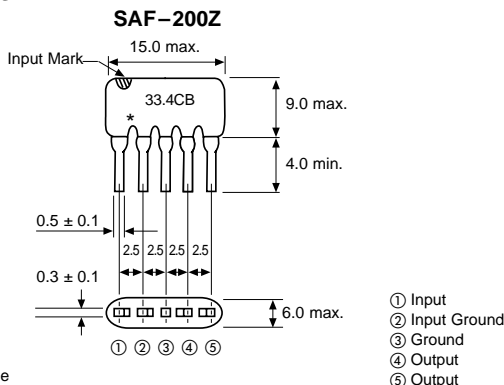

* : EIA-J Date Code

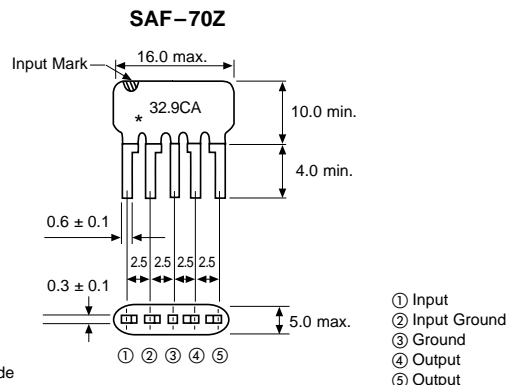

* : EIA-J Date Code

- Since the insertion loss of surface acoustic wave filters varies with the matching state, the values of insertion loss in the table are not always in conformity with insertion loss of the actual circuit. () : Typ. values
- fp—picture carrier, fc—chroma carrier, fs—sound carrier, fas—adjacent sound carrier, fap—adjacent picture carrier.

FREQUENCY CHARACTERISTICS

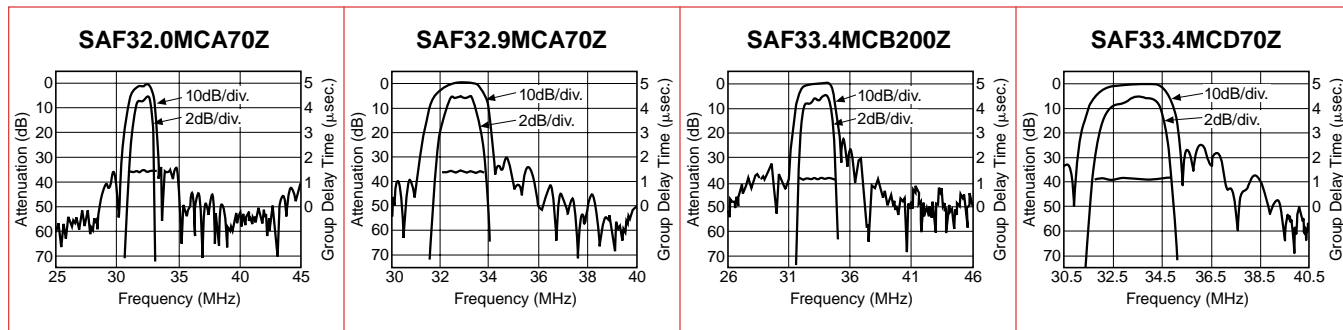

PIEZO FILTERS

PIEZO FILTERS

SAW FILTERS FOR AUDIO VISUAL EQUIPMENT

MULTI TV/VCR/VIF



This series of saw filters is designed for TV/VCR applications. These filters are capable of passing 1) SIF and PIF, 2) SIF or 3) PIF. Saw filters are made up of zinc oxide on a glass substrate. Murata provides saw filters for a variety of television standards worldwide.

SPECIFICATIONS

SAF

| Part Number | Insertion Loss (dB) max. | Picture Carrier (dB) | Chroma Carrier (dB) | Sound 1 Carrier (dB) | Sound 2 Carrier (dB) | Sound 3 Carrier (dB) | Adjacent Sound Carrier (dB) min. | Adjacent Picture Carrier (dB) min. | Spurious Response (dB) min. | Temperature Coefficient (ppm/°C) | System |
|----------------|--------------------------|----------------------|---------------------|----------------------|----------------------|----------------------|----------------------------------|------------------------------------|-----------------------------|----------------------------------|-----------|
| SAF38.0MZE210Z | 27(22) | 4.8 ± 1.2 | 3.8 ± 1.3 | 17.5 ± 3.0 | — | 17.0 ± 3.0 | 40(53) | 40(53) | 30(43) | -10 ± 20 | D/K/B/G/I |
| SAF38.0MZJ80Z | 29(26) | 5.1 ± 1.2 | 4.1 ± 1.5 | 22.0 ± 3.0 | — | 19.5 ± 3.0 | 40(56) | 40(55) | 30(40) | -10 ± 20 | D/K/B/G/I |
| SAF38.9MX200Z | 26(23) | 5.0 ± 1.2 | 3.4 ± 1.0 | 18.0 ± 3.0 | 15.0 ± 3.0 | 22.0 ± 4.0 | 40(48) | 35(41) | 30(38) | -10 ± 20 | B/G/I/D/K |
| SAF38.9MZA80Z | 25(22) | 4.5 ± 1.3 | 4.5 ± 1.3 | 16.5 ± 3.0 | 15.0 ± 3.0 | 20.0 ± 3.0 | 45(53) | 40(58) | 30(46) | -10 ± 20 | B/G/I/D/K |
| SAF38.9MZC200Z | 25.5(22) | 3.7 ± 1.3 | 4.3 ± 1.3 | 15.5 ± 3.0 | — | 16.5 ± 3.0 | 40(50) | 40(47) | 30(36) | -10 ± 20 | B/G/I/D/K |

DIMENSIONS: mm

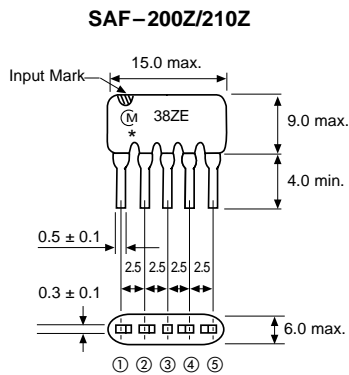

- ① Input
- ② Input Ground
- ③ Ground
- ④ Output
- ⑤ Output

* : EIA-J Date Code

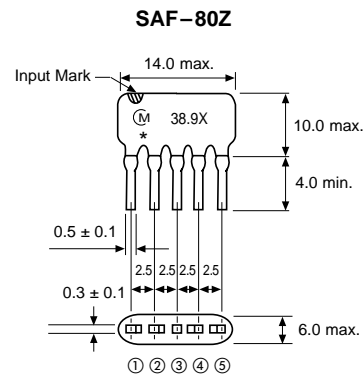

- ① Input
- ② Input Ground
- ③ Ground
- ④ Output
- ⑤ Output

* : EIA-J Date Code

() : Typ. values

FREQUENCY CHARACTERISTICS

SAF38.0MZE210Z

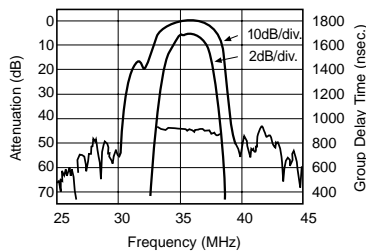

SAF38.9MX200Z

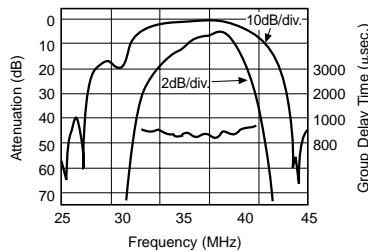

SAF38.9MZA80Z

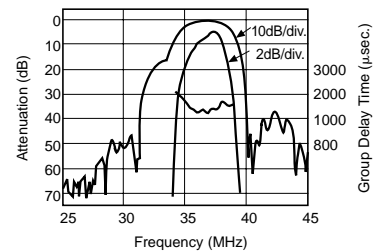

PIEZO FILTERS SAW FILTERS FOR AUDIO VISUAL EQUIPMENT

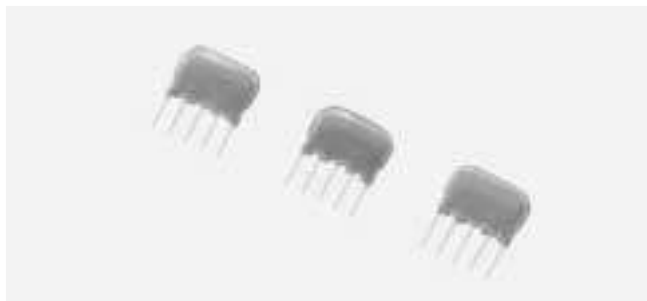

This series of saw filters is designed for TV/VCR applications. These filters are capable of passing 1) SIF and PIF, 2) SIF or 3) PIF. Saw filters are made up of zinc oxide on a glass substrate. Murata provides saw filters for a variety of television standards worldwide.

SPECIFICATIONS

SAF

| Part Number | Insertion Loss (dB) max. | Picture Carrier (dB) | Chroma Carrier (dB) | Sound Carrier (dB) | Adjacent Sound Carrier (dB) min. | Attenuation at fap +1.0MHz (dB) min. | Attenuation at fap -0.5MHz (dB) min. | Adjacent Picture Carrier (dB) min. | Attenuation at fap -0.5 MHz (dB) min. | Spurious Response (dB) min. | Temperature Coefficient (ppm/°C) |
|----------------|--------------------------|----------------------|---------------------|--------------------|----------------------------------|--------------------------------------|--------------------------------------|------------------------------------|---------------------------------------|-----------------------------|----------------------------------|
| SAF38.9MZ215Z | 24.0(19) | 5.0 ± 1.2 | 5.8 ± 1.5 | 19.0 ± 2 | 44(56) | 42(52) | — | 45(50) | — | 36 | -10 ± 20 |
| SAF38.9MZR80Z | 24.0(22) | 4.5 ± 1.2 | 4.5 ± 1.5 | 22.0 ± 3 | 40(48) | 38(48) | 35(45) | 40(48) | 37(50) | 30 | -10 ± 20 |
| SAF38.9MZW210Z | 22.5(20) | 4.5 ± 1.2 | 3.1 ± 1.0 | 17.5 ± 3 | 43(54) | 38(52) | 38(42) | 36(42) | 38(42) | 33 | -10 ± 20 |

DIMENSIONS: mm SAF-210Z/215Z

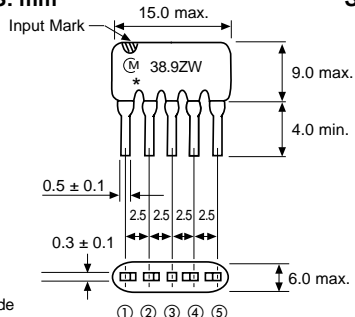

- ① Input
- ② Input Ground
- ③ Ground
- ④ Output
- ⑤ Output

* : EIA-J Date Code

DIMENSIONS: mm SAF-80Z

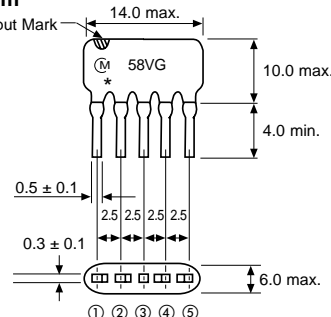

- ① Input
- ② Input Ground
- ③ Ground
- ④ Output
- ⑤ Output

* : EIA-J Date Code

FREQUENCY CHARACTERISTICS

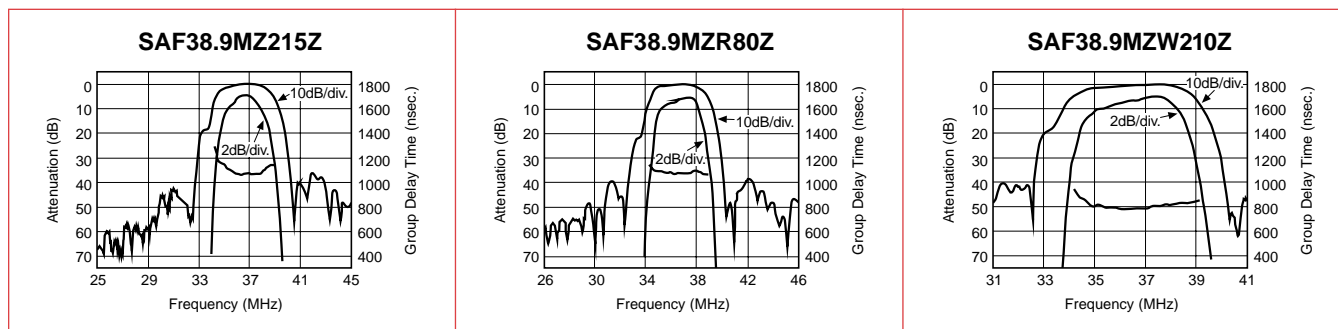

SPECIFICATIONS

SAF

| Part Number | Insertion Loss (dB) max. | Picture Carrier (dB) | Chroma Carrier (dB) | Sound Carrier (dB) | Attenuation at fap -4.0MHz (dB) max. | Adjacent Sound Carrier (dB) min. | Adjacent Picture Carrier (dB) min. | Spurious Response (dB) min. | Temperature Coefficient (ppm/°C) |
|-------------|--------------------------|----------------------|---------------------|--------------------|--------------------------------------|----------------------------------|------------------------------------|-----------------------------|----------------------------------|
| SAF58MVG80Z | 23(20) | 4.8 ± 1.2 | 1.0 | 20 | 5.0(2.0) | 40(53) | 40(58) | 30 | -28 ± 20 |
| SAF45MVE80Z | 23(20) | 5.0 ± 1.2 | 1.2 | 20 | 5.5(2.7) | 40(48) | 40(53) | 28 | -28 ± 20 |

DIMENSIONS: mm

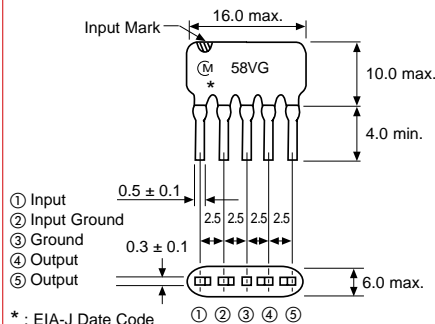

- ① Input
- ② Input Ground
- ③ Ground
- ④ Output
- ⑤ Output

* : EIA-J Date Code

FREQUENCY CHARACTERISTICS

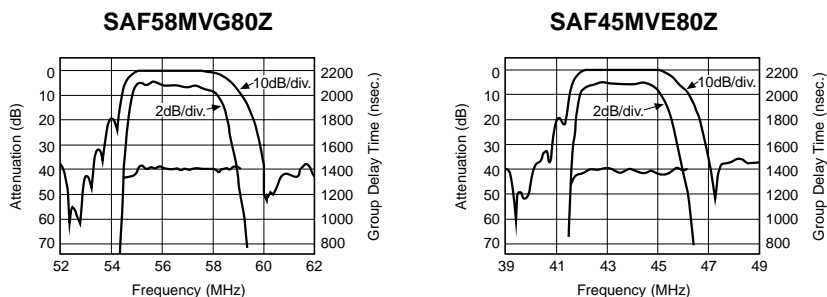

PIEZO FILTERS

SAW FILTERS FOR AUDIO VISUAL EQUIPMENT

COLOR TV VIF/VCR



SAF Series

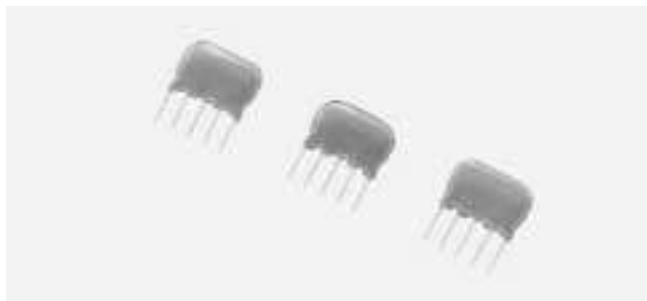

This series of saw filters are designed for TV/VCR applications. These filters are capable of passing SIF, PIF, SIF or PIF. Saw filters are made up of zinc oxide on a glass substrate. Murata provides saw filters for a variety of television standards world wide.

SPECIFICATIONS

SAF

| Part Number | Insertion Loss (dB) max. | Picture Carrier (dB) | Chroma Carrier (dB) | Sound Carrier (dB) | Adjacent Sound Carrier (dB) min. | Adjacent Picture Carrier (dB) min. | Spurious Response (dB) min. | Temperature Coefficient (ppm/°C) |
|----------------|--------------------------|----------------------|---------------------|--------------------|----------------------------------|------------------------------------|-----------------------------|----------------------------------|
| SAF58MH210Z | 21(17) | 4.2 ± 1.2 | 4.2 ± 1.5 | 20 ± 3 | 40(57) | 40(53) | 30 | -28 ± 20 |
| SAF45MA210Z | 21(18) | 4.0 ± 1.2 | 4.5 ± 1.5 | 18 ± 3 | 40(54) | 40(47) | 30 | -28 ± 20 |
| SAF39.5MZ210Z | 25(22) | 5.0 ± 1.2 | 4.5 ± 1.5 | 20 ± 3 | 40(52) | 40(55) | 30 | -10 ± 20 |
| SAF38.9MZ210Z | 24(19) | 5.0 ± 1.2 | 5.8 ± 1.5 | 20 ± 3 | 40(55) | 40(47) | 30 | -10 ± 20 |
| SAF38.0MZ210Z | 27(25) | 6.0 ± 1.5 | 6.6 ± 1.5 | 25 ± 3 | 40(48) | 40(55) | 30 | -10 ± 20 |
| SAF36.9MZ80Z | 25(21) | 5.0 ± 1.2 | 5.0 ± 1.5 | 20 ± 3 | 40(50) | 40(53) | 30 | -10 ± 20 |
| SAF32.7MZ80Z | 25(22) | 6.5 ± 1.5 | 1.0 ± 1.0 | 38 min. | 40(48) | 35(48) | 30 | -10 ± 20 |
| SAF58MVB200Z | 20(15) | 4.5 ± 1.2 | 4.5 ± 1.5 | 25 min. | 40(55) | 40(57) | 30 | -28 ± 20 |
| SAF45MVG200Z | 21(19) | 4.5 ± 1.2 | 4.5 ± 1.5 | 25 min. | 40(55) | 40(47) | 29 | -28 ± 20 |
| SAF38.9MVB200Z | 24(21) | 4.5 ± 1.2 | 4.8 ± 1.5 | 25 min. | 40(48) | 40(55) | 30 | -10 ± 20 |

DIMENSIONS: mm

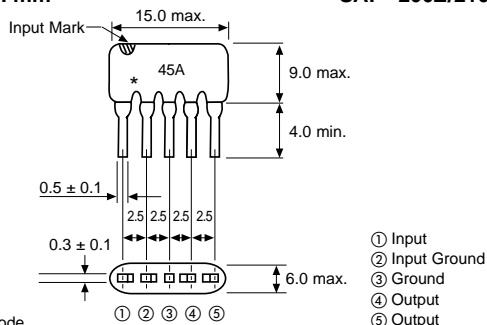

* : EIA-J Date Code

DIMENSIONS: mm

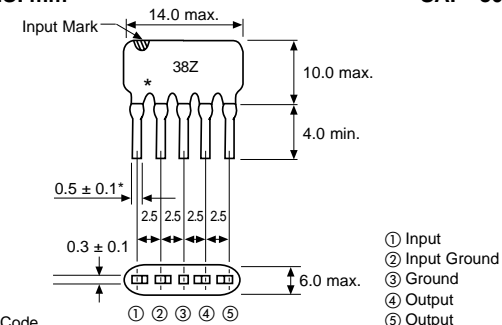

* : EIA-J Date Code

- SAF58MVB200Z, SAF45MVG200Z and SAF38.9MVB200Z are for picture IF filters in quasi-parallel or split carrier systems.
- Low-profile type 6.0mm (60Z) is also available.

(): Typ. values

FREQUENCY CHARACTERISTICS

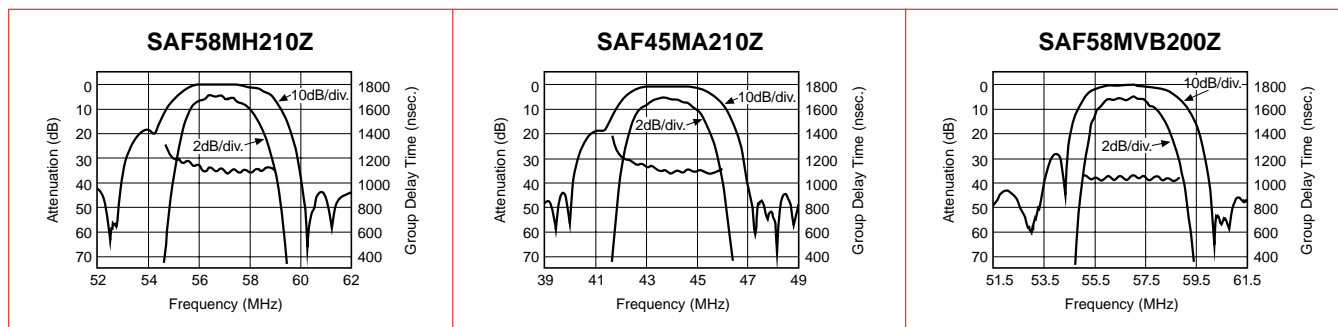

PIEZO FILTERS SAW FILTERS FOR SET TOP BOX (CATV)

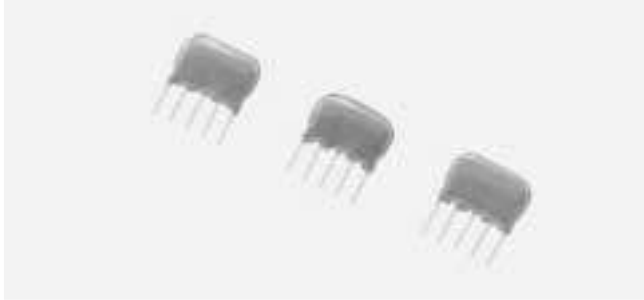

This series of saw filters is designed for TV/VCR applications. These filters are capable of passing 1) SIF and PIF, 2) SIF or 3) PIF. Saw filters are made up of zinc oxide on a glass substrate. Murata provides saw filters for a variety of television standards worldwide.

SPECIFICATIONS

SAF

| Part Number | Insertion Loss (dB) max. | Flatness (dB) max. | Lower ch. Picture Carrier (dB) min. | Lower ch. Sound Carrier (dB) min. | Picture Carrier (dB) | Chroma Carrier (dB) | Sound Carrier (dB) | Upper ch. Picture Carrier (dB) min. | Spurious Response (dB) min. | Temperature Coefficient (ppm/°C) |
|-------------|--------------------------|--------------------|-------------------------------------|-----------------------------------|------------------------|------------------------|---------------------|-------------------------------------|-----------------------------|----------------------------------|
| SAF45MT210Z | 23 | 2 ¹⁰ | 14 | — | 2 max. | 2 max. | 2 max. | 30 | 27 | -28 ± 20 |
| SAF55MB70Z | 21 | 2 | 35 | 8 | 0 | 0 ± 1 | 2 max. | 35 | 26 | -28 ± 20 |
| SAF58MT71Z | 22 | 2 | 14 | 8 | 2 | 2 | 2 | 30 | 27 | -28 ± 20 |
| SAF61MB210Z | 20 | 1 ² | 35 | 8 | 0 | 0 ± 1 | 2 max. | 35 | 26 ⁶ | -28 ± 20 |
| SAF61MD210Z | 23 | 2 ³ | 30 ⁴ | 8 ⁴ | 2 max. ⁴ | 2 max. | 2 max. | 14 ⁴ | 27 | -28 ± 20 |
| SAF61MZ72Z | 22 | — | 30 ⁴ | 40 ⁴ | 5.5 ± 1.2 ⁴ | 5.0 ± 1.5 ⁴ | 20 ± 3 ⁴ | 40 ⁴ | 28 | -28 ± 20 |
| SAF67MB70Z | 20 | 2 | 35 | 8 | 0 | 0 ± 1 | 2 max. | 35 | 26 | -28 ± 20 |

Note: SAF55MB70Z is full channel pass filter for channel 2. SAF61MB70Z is full channel pass filter for channel 3. SAF67MB70Z is full channel pass filter for channel 4. For channel 2 SAF59.8MA72Z, channel 3 SAF65.8MA72Z and channel 4 SAF71.8MA72Z is the Sound Intermediate Frequency (SIF).
 • SAF61MD70Z is a wide-band type. SAF61MZ72Z is for direct detection systems. * Reference Point. ²61.25 – 64.83MHz. ³61.25 – 65.75MHz. ⁴Reference level (0dB) is the peak value. ⁵50–55.25MHz 67.25–78MHz ⁶0–55.25MHz 67.25–80MHz ⁷0–55.25MHz 68.25–80MHz ⁸30: 0–59.75MHz 28: 67.25–80MHz ⁹41.25–45.75MHz

DIMENSIONS: mm

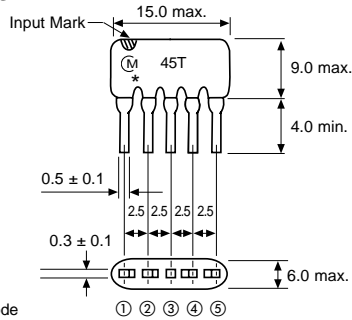

* : EIA-J Date Code

SAF-210Z

DIMENSIONS: mm

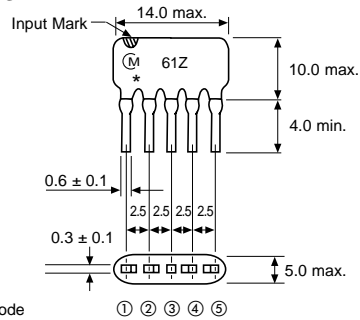

* : EIA-J Date Code

SAF-70Z

FREQUENCY CHARACTERISTICS

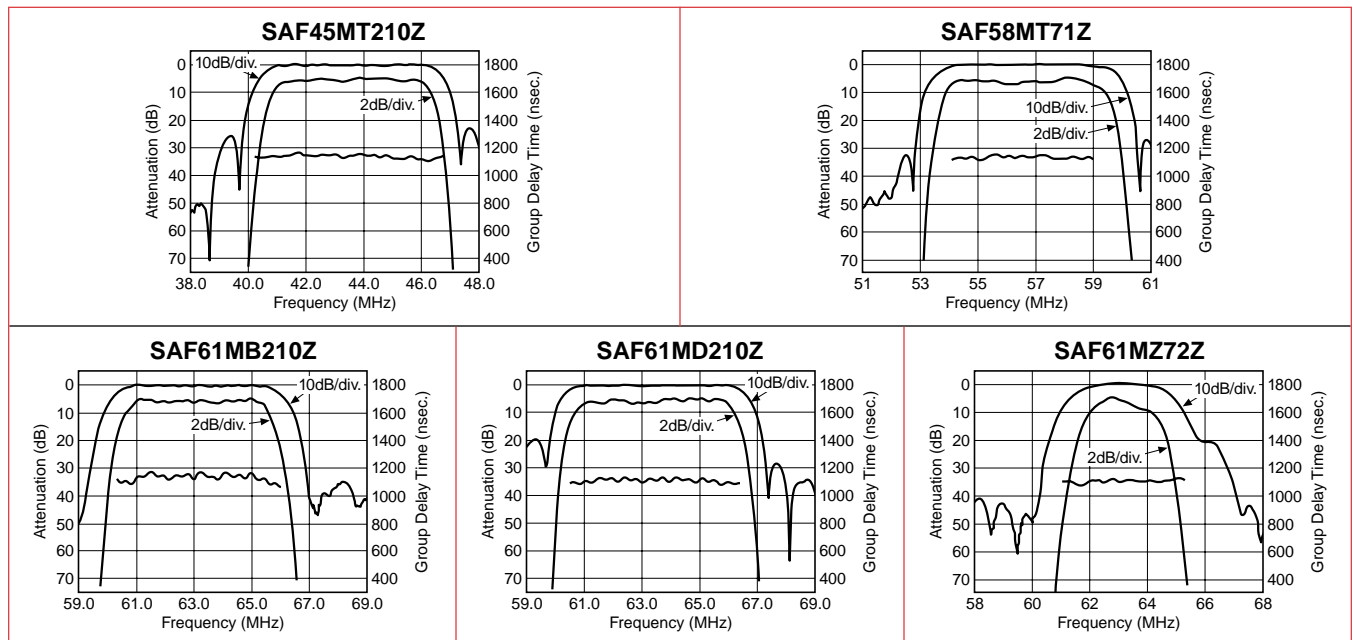

PIEZO FILTERS

PIEZO FILTERS SAW FILTERS FOR SET TOP BOX (CATV)

SAF Series

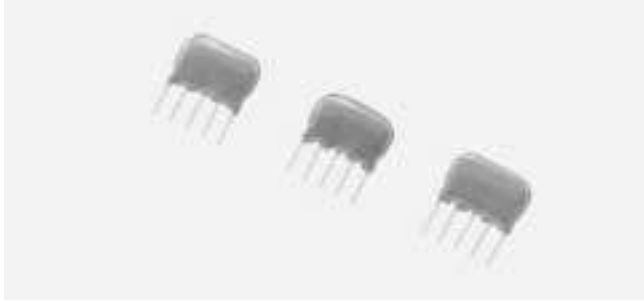

This series of saw filters is designed for TV/VCR applications. These filters are capable of passing 1) SIF and PIF, 2) SIF or 3) PIF. Saw filters are made up of zinc oxide on a glass substrate. Murata provides saw filters for a variety of television standards worldwide.

SPECIFICATIONS

SAF

| Part Number | Insertion Loss (dB max.) | Picture Carrier (dB) | Attenuation (dB) at $f_s - 0.25\text{MHz}$ | Attenuation (dB) at $f_s + 0.25\text{MHz}$ | Upper ch. Picture Carrier (dB) | Spurious Response (dB) min. | Temperature Coefficient (ppm/°C) |
|--------------|--------------------------|----------------------|--|--|--------------------------------|-----------------------------|----------------------------------|
| SAF65.8MA72Z | 18 | — | 3 | 3 | — | 20* | -28 ± 20 |
| SAF41MCA70Z | 17 | (40) | ($f_s - 0.2\text{MHz}$) 3.5 | ($f_s + 0.2\text{MHz}$) 3.5 | (37) | 30 | -28 ± 20 |

* The level at sound carrier frequency (f_s) is to be the reference (0dB).

*0-64.7 MHz, 66.8-100MHz.

DIMENSIONS: mm

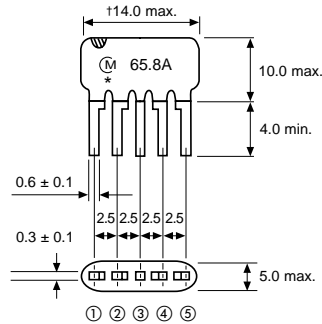

* : EIA-J Date Code

†SAF41MCA70Z = 16.0 max.

FREQUENCY CHARACTERISTICS

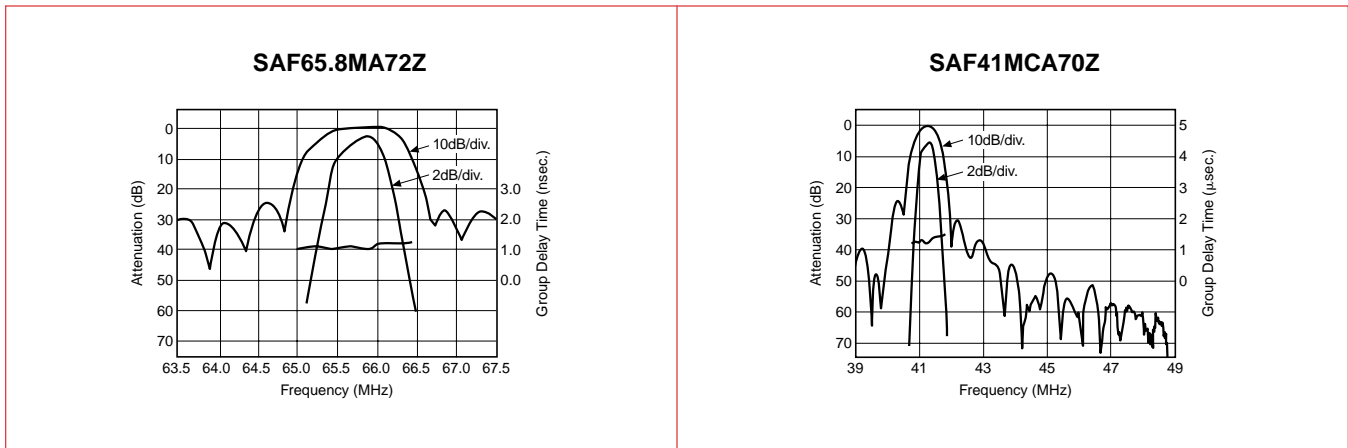

PIEZO FILTERS

SAW FILTERS FOR CABLE MODEM DTV/DIGITAL CATV

NEW

muRata
Innovator in Electronics

SAF Series



To meet the needs of the newest emerging technologies, Murata now offers a line of SAW filters designed for Digital Television, Digital Cable Television, and Cable Modem applications.

SPECIFICATIONS

SAF MHz

| Part Number | SAF44MTC80ZL | SAF44.00MTD220ZL | SAF44.00MTE220ZL |
|--|---|--|---|
| Insertion Loss (at 44.00 MHz) | 22.0dB | 20.5dB | 21.0dB |
| Amplitude Response dB | 39.75MHz | 35.0 min. | — |
| | 40.00MHz | — | 32.0 min. |
| | 40.50MHz | — | 10.0 min. |
| | 41.00MHz | — | 3.5 ± 1.5 |
| | 41.31MHz | 0.7 ± 1.3 | — |
| | 41.47MHz | — | 0.0 ± 1.2 |
| | 46.53MHz | — | 0.0 ± 1.2 |
| | 46.69MHz | 1.5 ± 1.5 | — |
| | 47.00MHz | — | 3.5 ± 1.5 |
| | 47.25MHz | 25.0 min. | — |
| 47.50MHz | — | 10.0 min. | |
| 48.00MHz | — | 34.0 min. | |
| Amplitude Ripple | 1.0dB p-p (41.62 to 46.38MHz) | 1.0dB p-p (41.00 to 47.00MHz) | 1.0dB p-p (41.00 to 47.00MHz) |
| GDT Ripple | 60 nsec. max. (41.62 to 46.38MHz) | 60 nsec. p-p max. (41.00 to 47.00MHz) | 60 nsec. p-p max. (41.00 to 47.00MHz) |
| Spurious Response (dB min.) (Reference Level at 44.00MHz) | 30.00 (0.00 to 40.00MHz) 30.00 (48.00 to 55.00MHz) | 30.0 (35.00 to 40.00MHz) 28.0 (48.00 to 55.00MHz) | 28.00 (0.00 to 40.00MHz) 25.00 (48.00 to 55.00MHz) |

PIEZO FILTERS

DIMENSIONS: mm

SAF-80Z

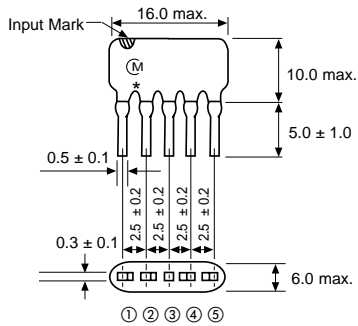

* : EIA-J Date Code

- ① Input
- ② Input Ground
- ③ Ground
- ④ Output
- ⑤ Output

DIMENSIONS: mm

SAF-220Z

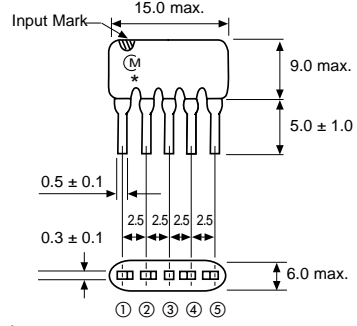

* : EIA-J Date Code

- ① Input
- ② Input Ground
- ③ Ground
- ④ Output
- ⑤ Output

TEST CIRCUIT

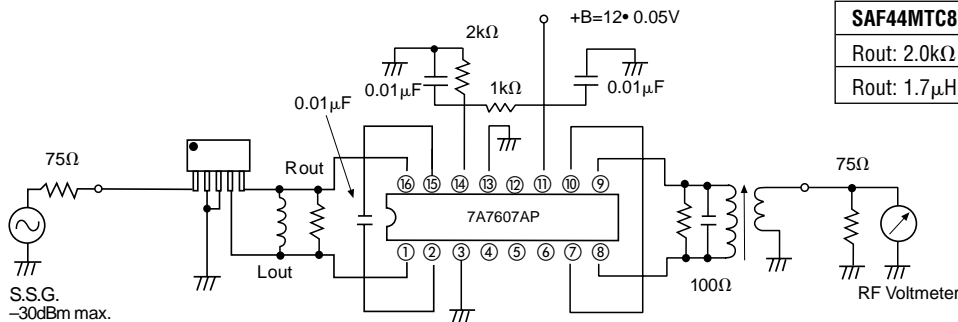

| SAF44MTC80ZL | SAF44.00MTD(E)220ZL |
|--------------|---------------------|
| Rout: 2.0kΩ | Rout: 3.0kΩ |
| Rout: 1.7μH | Lout: 1.55μH |

PIEZO FILTERS SAW FILTERS FOR AUDIO VISUAL EQUIPMENT TAPING DIMENSIONS

SPECIFICATIONS

| Item | Code | Part Number | | | |
|---|----------------|--------------------------|-----------------|------------------------------|-----------------|
| | | SAF□M80Z-TF/SAF□M200Z-TF | | SAF□M80Z-TF01/SAF□M200Z-TF01 | |
| | | Nominal Value | Allowable Value | Nominal Value | Allowable Value |
| Portion to cut in case of defect | L ₁ | 3 | min. | 3 | min. |
| Pitch of component | P | 25.4 | ±0.5 | 25.4 | ±0.5 |
| Pitch of sprocket hole | P ₀ | 12.7 | ±0.2 | 12.7 | ±0.2 |
| Feed hole position to SAW filter terminal | P ₁ | 3.85 | ±0.5 | 3.85 | ±0.5 |
| Feed hole position to SAW filter terminal | P ₂ | 6.35 | ±0.5 | 6.35 | ±0.5 |
| Terminal spacing ⁽¹⁾ | F | 5.0 | +0.5 -0.2 | 5.0 | +0.5 -0.2 |
| Terminal spacing ⁽²⁾ | F ₁ | 2.5 | ±0.2 | 2.5 | ±0.2 |
| Deviation across tape | Δh | 0 | ±1.0 | 0 | ±1.0 |
| Deviation along tape, left or right | Δs | 0 | ±1.0 | 0 | ±1.0 |
| Carrier tape width | W | 18.0 | ±0.5 | 18.0 | ±0.5 |
| Hold-down tape width | W ₀ | 6.0 | min. | 6.0 | min. |
| Position of sprocket hole | W ₁ | 9.0 | ±0.5 | 9.0 | ±0.5 |
| Hold-down tape width | W ₂ | 0 | ±0.5 | 0 | ±0.5 |
| Distance between reference and terminal | H ₀ | 16.0 | ±0.5 | 18.0 | ±0.5 |
| Height of terminal stopper | H | 19.25 | ±0.5 | 21.25 | ±0.5 |
| Distance between reference and top | H ₁ | 32.0 | max. | 32.0 | max. |
| Diameter of sprocket hole | D ₀ | φ4.0 | ±0.2 | φ4.0 | ±0.2 |
| Total tape thickness | t | 0.6 | ±0.2 | 0.6 | ±0.2 |

DIMENSIONS: mm

SAF□M200Z-TF01/SAF□M80Z-TF01

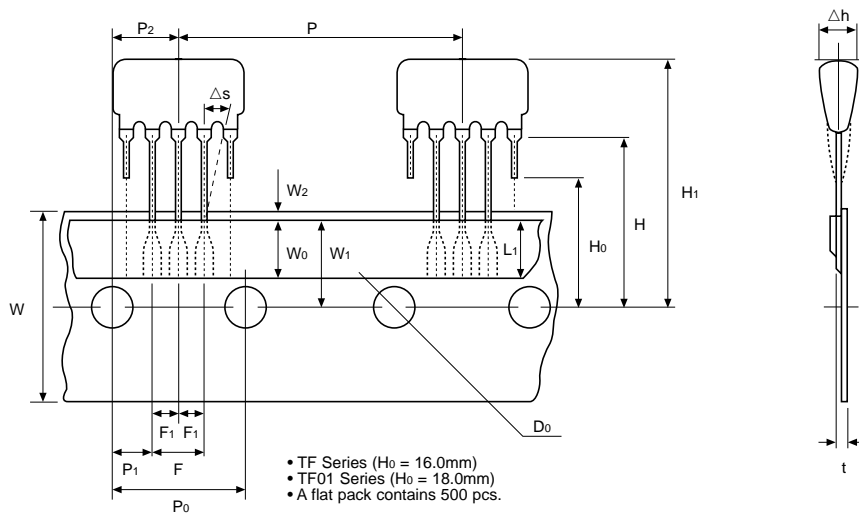

•The differences between TF and TF01 are only the dimensions of H_0 (16mm or 18mm) and H (19.25mm or 21.25mm).

PIEZO FILTERS HIGH FREQUENCY TRAP FOR TV/VCR APPLICATIONS

NEW

muRata
Innovator in Electronics

MKT Series



MKT is a high frequency trap for television or other similar systems.

SPECIFICATIONS

| Part Number | Nominal Center Frequency (MHz) | 10dB Band Width (kHz) min. | Ripple (dB) max. | *Attenuation (dB) max. |
|---------------|--------------------------------|----------------------------|------------------|------------------------|
| MKT47.3MA110P | 47.25 | 65 | 1.0 | 2.0 |
| MKT40.4MA110P | 40.4 | 65 | 1.0 | 2.0 |
| MKT31.9MA110P | 31.9 | 65 | 1.0 | 2.0 |

DIMENSIONS: mm

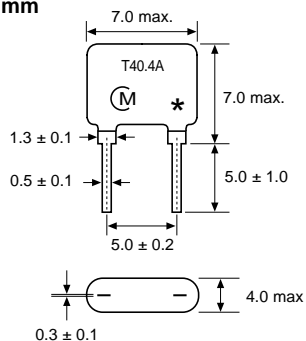

CIRCUIT

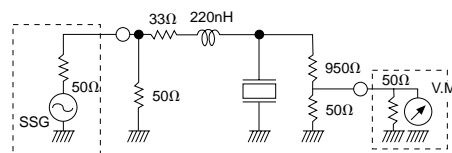

*Attenuation at fp

•Attenuation MKT40.4MA110P: 38.9MHz point, MKT31.9MA110P: 33.4MHz point.

•30.9MHz, 39.5MHz, 47.25MHz and 60.25MHz types are also available.

FREQUENCY CHARACTERISTICS

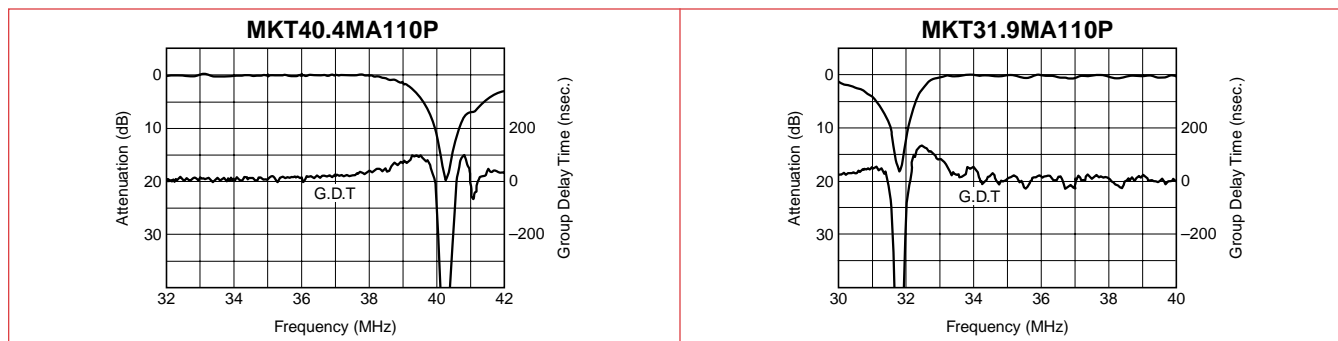

PART NUMBER LIST

| Part Number | Nominal Center Frequency (MHz) | Picture Carrier (fp) (MHz) | System | Application | Matching Impedance (R/L) (Ohms/nH) |
|---------------|--------------------------------|----------------------------|-------------|-------------|------------------------------------|
| MKT30.0MA110P | 30.0 | 38.0 | B/G/I/D/K | fap | 20/— |
| MKT32.0MA110P | 32.0 | 38.0 | M | fap | 20/— |
| MKT39.5MA110P | 39.5 | 38.0 | B/G/I/D/K/M | fas | 33/220 |
| MKT30.9MA110P | 30.9 | 38.9 | I/D/K | fap | 20/— |
| MKT31.9MA110P | 31.9 | 38.9 | B/G | fap | 20/— |
| MKT40.4MA110P | 40.4 | 38.9 | B/G/I/D/K | fas | 33/220 |
| MKT31.5MA110P | 31.5 | 39.5 | I | fap | 20/— |
| MKT41.5MA110P | 41.5 | 39.5 | I | fas | 33/220 |
| MKT31.2MA110P | 31.2 | 32.7 | L | fas | 20/— |
| MKT40.7MA110P | 40.7 | 32.7 | L | fap | 33/220 |
| MKT39.8MA110P | 39.75 | 45.75 | M | fap | 20/— |
| MKT47.3MA110P | 47.25 | 45.75 | M | fas | 27/180 |
| MKT52.8MA110P | 52.75 | 58.75 | M | fap | 10/— |
| MKT60.3MA110P | 60.25 | 58.75 | M | fas | 22/150 |

• Available frequency range: Center frequency 30 to 70MHz.

• Application fap: For adjacent picture frequency.

• Application fas: For adjacent sound frequency.