

Filterelement Filter element

0330D0100N

Material-Nr.:

Material no.:

Bezeichnung:

Designation:

Filterfeinheit¹:

10 µm

Filtration grade¹:

Filtrationsquotient¹:

$\beta_{10}(c) = 200 / \beta_{11}(c) = 1000$ (ISO 16889)

Filtration ratio¹:

Filtermaterial¹:

Glasfasermaterial PWR / H..XL

Filter media¹:

glass fiber material PWR / H..XL

Kollapsdruckbeständigkeit bar [psi]:

30 [435]

Collapse pressure rating bar [psi]:

Temperaturbeständigkeit °C [°F]:

-40...100 [-40...212]

Temperature rating °C [°F]:

Bypass Öffnungsdruck bar [psi]:

∅

Bypass cracking pressure bar [psi]:

Dichtungswerkstoff:

NBR

Sealing material:

Abmessungen mm [inch]:

Dimensions mm [inch]:

OD = 90,5 [3.6]

ID = 48,1 [1.9]

L = 163,5 [6.4]

Gewicht kg [lbs]: 0,7 [1.4]

Weight kg [lbs]:

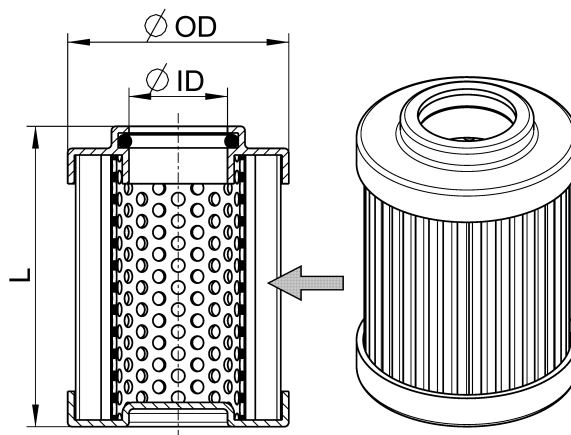

Vereinfachte Darstellung
The drawing shown is a simplistic representation