

Filterelement Filter element

0160D0100N

Material-Nr.:

Material no.:

Bezeichnung:

Designation:

Filterfeinheit¹:

10 µm

Filtration grade¹:

Filtrationsquotient¹:

$\beta_{10}(c) = 200 / \beta_{11}(c) = 1000$ (ISO 16889)

Filtration ratio¹:

Filtermaterial¹:

Glasfasermaterial PWR / H..XL

Filter media¹:

glass fiber material PWR / H..XL

Kollapsdruckbeständigkeit bar [psi]:

30 [435]

Collapse pressure rating bar [psi]:

Temperaturbeständigkeit °C [°F]:

-40...100 [-40...212]

Temperature rating °C [°F]:

Bypass Öffnungsdruck bar [psi]:

∅

Bypass cracking pressure bar [psi]:

Dichtungswerkstoff:

NBR

Sealing material:

Abmessungen mm [inch]:

Dimensions mm [inch]:

OD = 69,0 [2.7]

ID = 34,1 [1.3]

L = 116,0 [4.6]

Gewicht kg [lbs]: 0,3 [0.7]

Weight kg [lbs]:

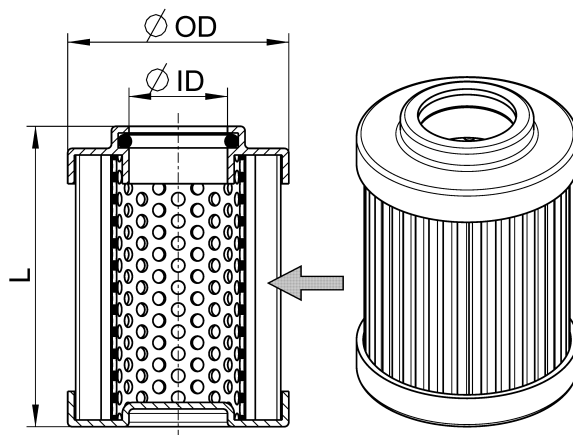

Vereinfachte Darstellung
The drawing shown is a simplistic representation