

















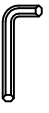

<b>#1</b> 5/16"x2-1/2" БОЛТ 12 ШТ 	<b>#2</b> 5/16" ШАЙБА 12 ШТ 	<b>#3</b> РЕГУЛИРОВОЧНАЯ НОЖКА 4 ШТ 	<b>#4</b> 1/4"x3" БОЛТ 8 ШТ 
<b>#5</b> 1/4x2-1/2" БОЛТ 8 ШТ 	<b>#6</b> 1/4" ШАЙБА 24 ШТ 	<b>#7</b> 1/4"x1/2" ГАЙКА 8 ШТ 	<b>#8</b> БОКОВАЯ ПАНЕЛЬ 2 ШТ 
<b>#9</b> НОЖКИ 4 ШТ 	<b>#10</b> ТОРЦЕВАЯ ПАНЕЛЬ 2 ШТ 	<b>#11</b> ИНСТРУМЕНТ 1 ШТ 	<b>#12</b> МЕЛОК 2 ШТ 
<b>#13</b> ЩЕТКА 1 ШТ 	<b>#14</b> КИИ 2 ШТ 	<b>#15</b> ТРЕУГОЛЬНИК 1 ШТ 	<b>#16</b> БИЛЬЯРДНЫЕ ШАРЫ 1 КОМПЛ 
<b>#17</b> ИНСТРУМЕНТ 1 ШТ 	<b>#18</b> ЦИЛИНДРИЧЕСКАЯ ГАЙКА 8 ШТ 1/4" 		

## БИЛЬЯРДНЫЙ СТОЛ ДФС DS-VT-P01 Vancouver

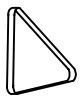
ВНИМАНИЕ: ДЛЯ СБОРКИ СТОЛА РЕКОМЕНДУЕТСЯ ДВОЕ ВЗРОСЛЫХ

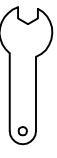
РИС.1

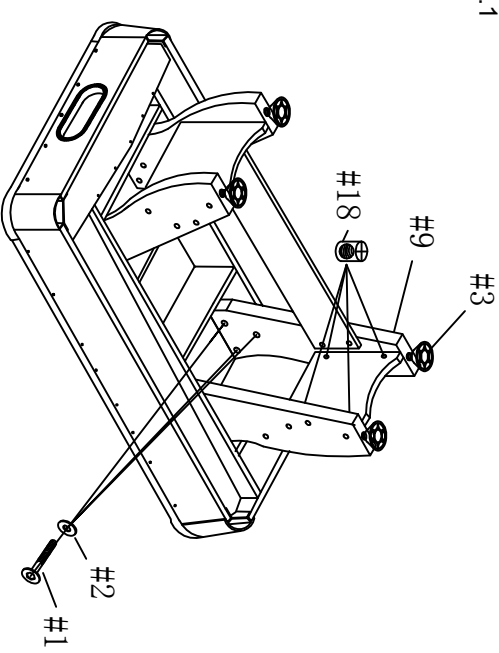

РИС.2

