

Technical Features

- > Designed to connect in parallel two or more ISO 4401-03 (CETOP 03) valves with integrated unloading and pressure relief valve cavity with interface 7/8-14-UNF-2A
- > Compact design with reduced plate dimensions for production cost saving
- > Maximum 10 parallel modular valve sections
- > Consumer ports A and B positioned on the side of the sub-plate
- > Maximum flow rate can be increased up to twice the output if the sub-plates are powered at both ends
- > Serial plates are available in aluminium EN AW - 7075 T6 and steel
- > In the standard version, the aluminium serial plate is without surface protection and the steel plate is zinc-coated for 520 h protection acc. to ISO 9227

ISO 4401-03-02-0-05

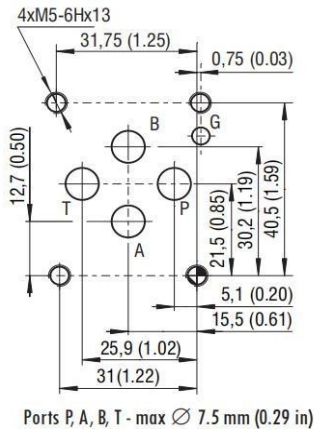

Technical Data

Modular valves mounting surface		06 (D03)
Cartridge cavity		B2
Max. operating pressure (aluminium)	bar (PSI)	320 (4640)
Max. operating pressure (steel)	bar (PSI)	350 (5080)
Port dimensions P		G1/2
Port dimensions T		G1/2
Port dimensions A, B		G3/8
Port dimensions M		G1/4
Weight (model 0, 1, 2)	kg (lbs)	see table

	Data Sheet	Type
General information	GI_0060	Products and operating conditions
Cavity details	SMT_0019	SMT_B2*
Mounting interface / tolerances	SMT_0019	Size 06
Studs and nuts for vertical stacking assemblies		HA_0020

Connection

DR2-06/ **0**

P, TG1/2
A, BG3/8

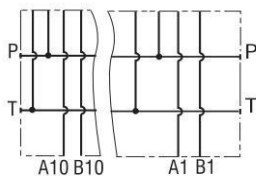

DR2-06/ **1**

P, TG1/2
A, BG3/8
MG1/4
valve cavity 7/8-14 UNF

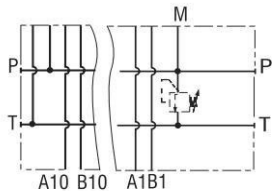

DR2-06/ **2**

P, TG1/2
A, BG3/8
MG1/4
2 valve cavities 7/8-14 UNF

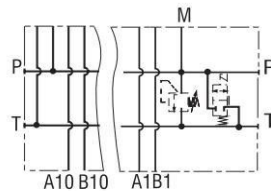

Port cavity A, B, P, T see page 2.

Ordering Code

DR2 - 06 / **-**

Serial plates for ISO 4401-03 valve with side ports

Nominal size

Number of sections

- | | |
|-------------|----|
| 1 section | 1 |
| 2 sections | 2 |
| 3 sections | 3 |
| 4 sections | 4 |
| 5 sections | 5 |
| 6 sections | 6 |
| 7 sections | 7 |
| 8 sections | 8 |
| 9 sections | 9 |
| 10 sections | 10 |

No designation

B

Surface treatment without treatment*
520 h salt spray test (ISO 9227)**
*only for aluminium plates
**only for steel plates

AL
ST

Material
aluminium EN AW - 7075 T6
steel

Cartridge cavity

without cavities
with one cavity for pressure or unloading valve
with two cavities for pressure relief and unloading valve

Dimensions in millimeters (inches)

DR2-06/ 0

DR2-06/ 1

DR2-06/ 2

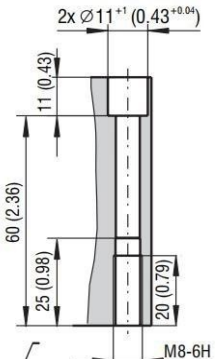
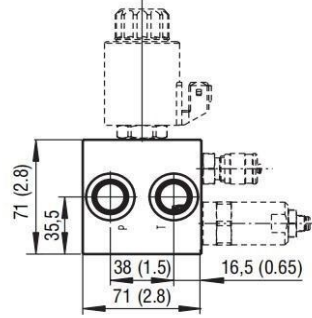
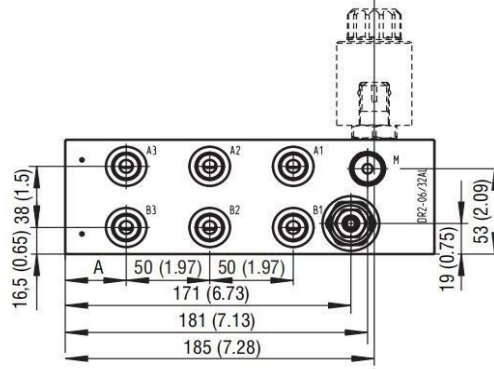
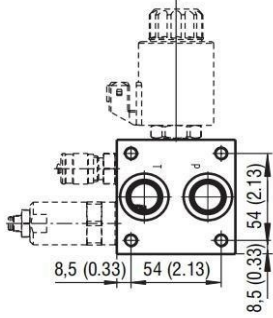
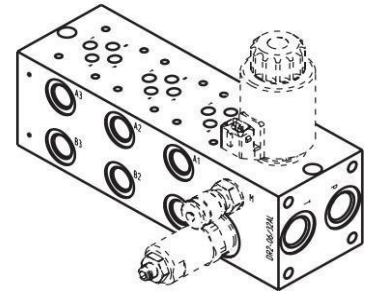
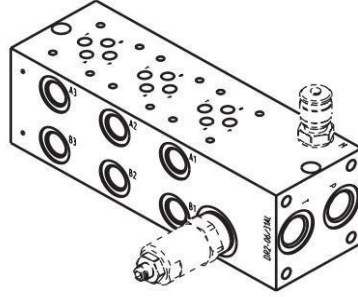
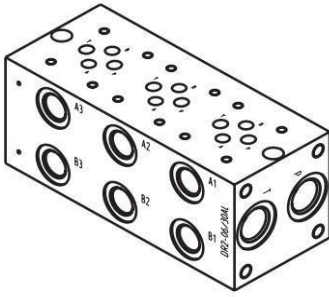

Port cavity A, B, P, T

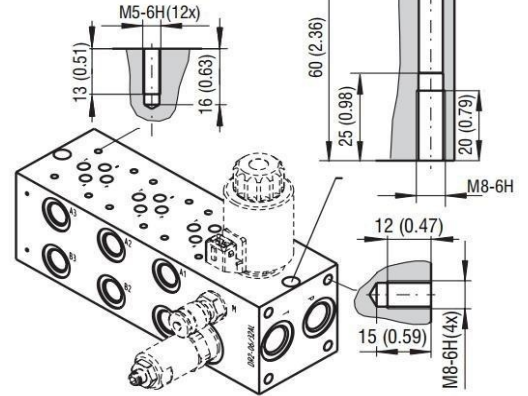
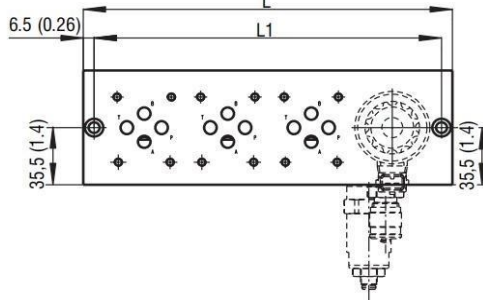
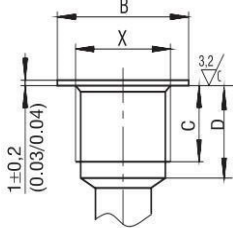

X	B [mm (in)]	C [mm (in)]	D [mm (in)]
G1/4	∅20±0.5 (0.79/0.81)	12±0.1 (0.47/0.48)	15±0.2 (0.58/0.60)
G3/8	∅23±0.5 (0.91/0.93)	12±0.1 (0.47/0.48)	15±0.2 (0.58/0.60)
G1/2	∅28±0.5 (1.11/1.12)	14±0.1 (0.55/0.56)	17±0.2 (0.66/0.68)

DR2-06	/*0		/*1(2)		/*0		/*1(2)		/*0		/*1(2)		AL - DR2-06/*0		ST - DR2-06/*0	
	Number of sec.	L [mm (in)]	L1 [mm (in)]	A [mm (in)]	Ordering number	Weight [kg (lb)]	Ordering number	Weight [kg (lb)]	Ordering number	Weight [kg (lb)]	Ordering number	Weight [kg (lb)]	Ordering number	Weight [kg (lb)]	Ordering number	Weight [kg (lb)]
1	71 (2.80)	121 (4.76)	58 (2.28)	108 (4.25)	35.5 (1.40)	36.5 (1.44)	27562600	0.83 (1.8)	28262900	2.33 (5.1)						
2	121 (4.76)	171 (6.73)	108 (4.25)	158 (6.22)	35.5 (1.40)	36.5 (1.44)	27562700	1.43 (3.2)	28263000	4.15 (9.2)						
3	171 (6.73)	221 (8.70)	158 (6.22)	208 (8.19)	35.5 (1.40)	36.5 (1.44)	27562800	2.03 (4.5)	28263100	5.70 (12.6)						
4	221 (8.70)	271 (10.67)	208 (8.19)	258 (10.16)	35.5 (1.40)	36.5 (1.44)	27562900	2.63 (5.8)	28263200	7.38 (16.3)						
5	271 (10.67)	321 (12.64)	258 (10.16)	308 (12.13)	35.5 (1.40)	36.5 (1.44)	27563000	3.23 (7.1)	28263300	9.07 (20.0)						
6	321 (12.64)	371 (14.61)	308 (12.13)	358 (14.09)	35.5 (1.40)	36.5 (1.44)	27563100	3.83 (8.4)	28263400	10.75 (3.7)						
7	371 (14.61)	421 (16.57)	358 (14.09)	408 (16.06)	35.5 (1.40)	36.5 (1.44)	27563200	4.43 (9.8)	28263500	12.43 (27.4)						
8	421 (16.57)	471 (18.54)	408 (16.06)	458 (18.03)	35.5 (1.40)	36.5 (1.44)	27563400	5.03 (11.1)	28263600	14.12 (31.1)						
9	471 (18.54)	521 (20.51)	458 (18.03)	508 (20.00)	35.5 (1.40)	36.5 (1.44)	40983800	5.66 (12.5)	40984400	15.80 (34.8)						
10	521 (20.51)	571 (22.48)	508 (20.00)	558 (21.97)	35.5 (1.40)	36.5 (1.44)	40983900	6.26 (13.8)	40984600	17.49 (38.6)						

Number of sec.	AL - DR2-06/*1		ST - DR2-06/*1	
	Ordering number	Weight [kg (lb)]	Ordering number	Weight [kg (lb)]
1	27563500	1.43 (3.2)	28263700	4.02 (8.9)
2	27563600	2.03 (4.5)	28263800	5.70 (12.6)
3	27563700	2.63 (5.8)	28263900	7.38 (16.3)
4	27563800	3.23 (7.1)	28264000	9.06 (20.0)
5	27563900	3.83 (8.4)	28264100	10.72 (23.6)
6	27564000	4.42 (9.7)	28264200	12.43 (27.4)
7	27564100	5.02 (11.1)	28264300	14.12 (31.1)
8	27564200	5.62 (12.4)	28264400	15.80 (34.8)
9	40984500	6.26 (13.8)	40984200	17.48 (38.5)
10	40984700	6.86 (15.1)	40984300	19.17 (42.3)

Number of sec.	AL - DR2-06/*2		ST - DR2-06/*2	
	Ordering number	Weight [kg (lb)]	Ordering number	Weight [kg (lb)]
1	27632300	1.38 (3.0)	28269600	3.88 (8.6)
2	27632500	1.98 (4.4)	28269700	5.57 (12.3)
3	27632600	2.58 (5.7)	28269800	7.25 (16.0)
4	27632700	3.18 (7.0)	28269900	8.94 (19.7)
5	27632800	3.78 (8.3)	28270000	10.62 (23.4)
6	27632900	4.38 (9.7)	28270100	12.30 (27.1)
7	27633000	4.98 (11.0)	28270200	13.99 (30.8)
8	27633100	5.58 (12.3)	28270300	15.67 (34.6)
9	40986500	6.18 (13.6)	40986400	17.36 (38.3)
10	40986600	6.78 (14.9)	40986300	19.05 (42.0)