

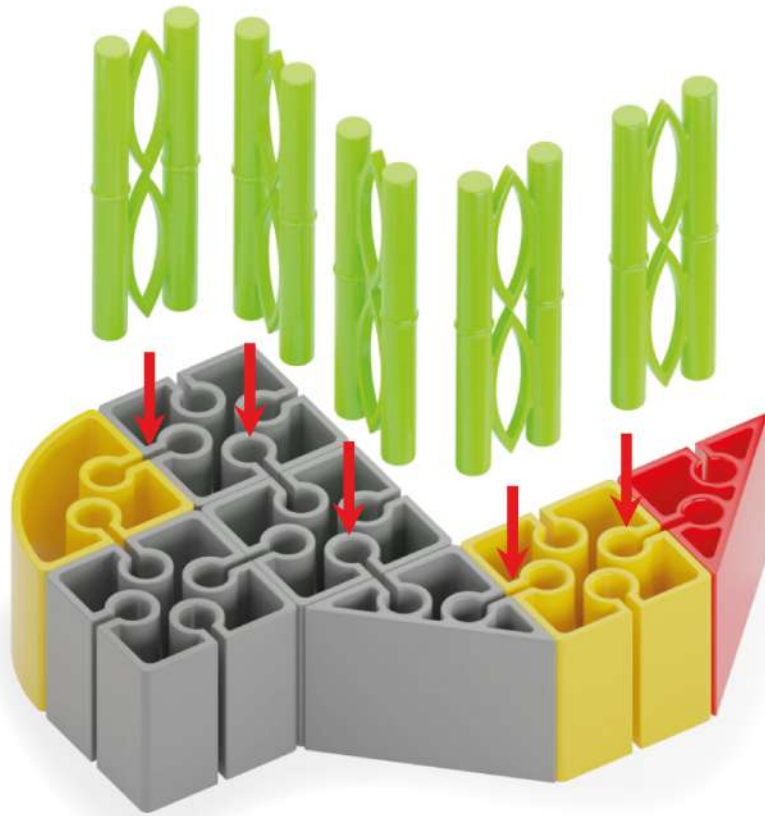





1





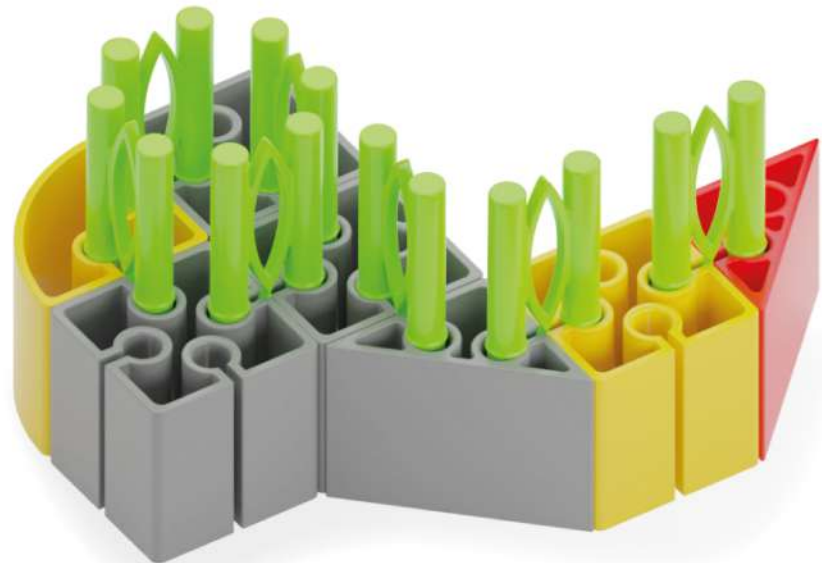
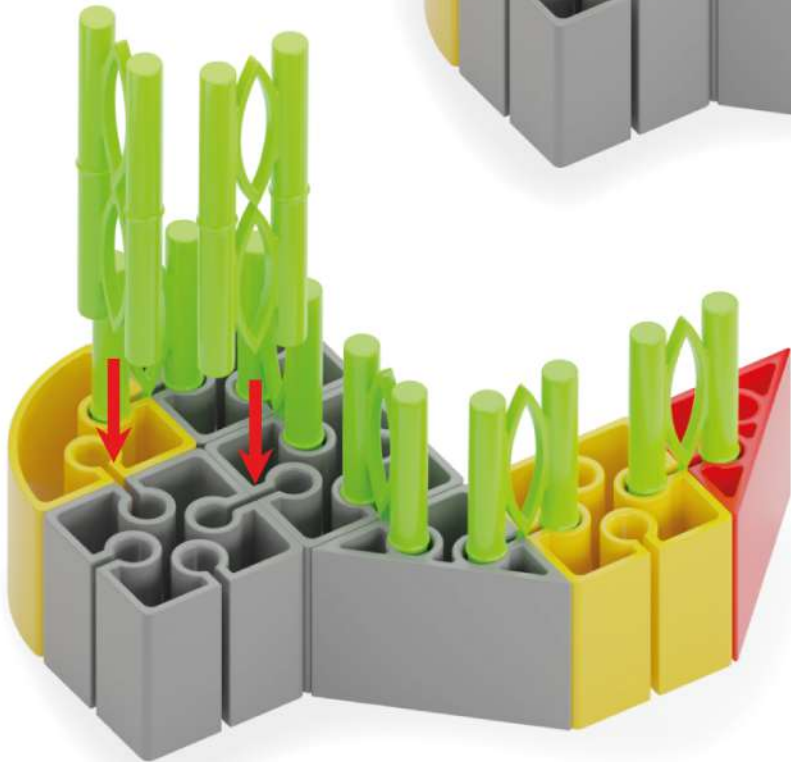

	x3		x1
	x1		x1
	x1		x7

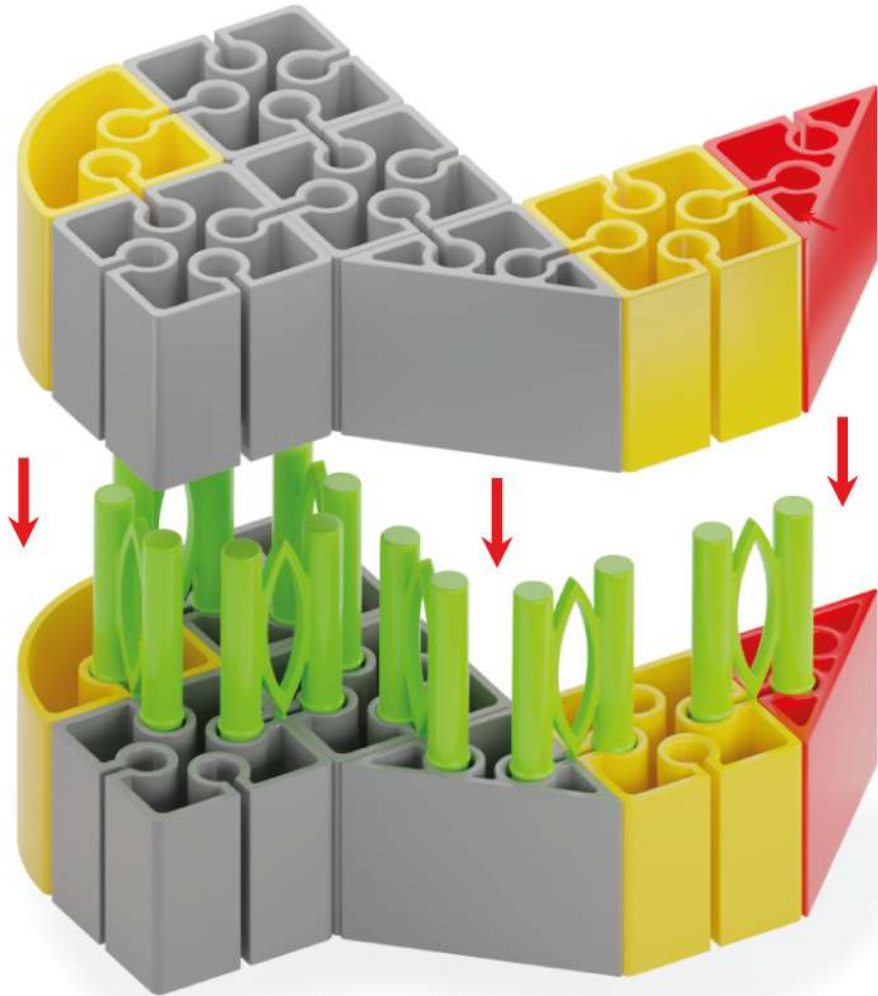

2



-  x1
-  x3
-  x1
-  x1
-  x1





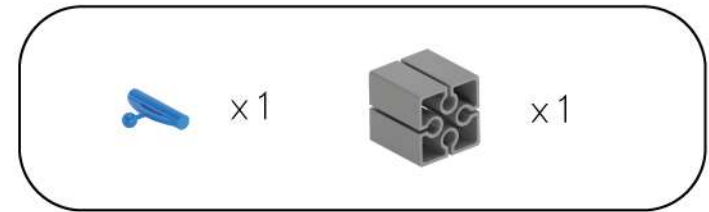
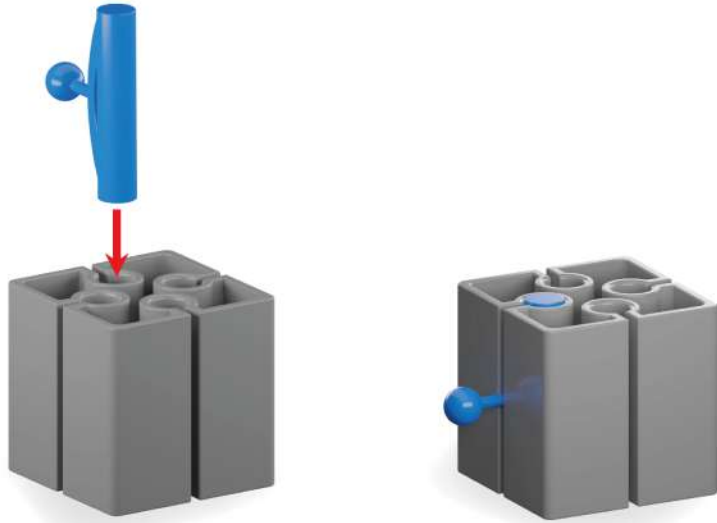

3

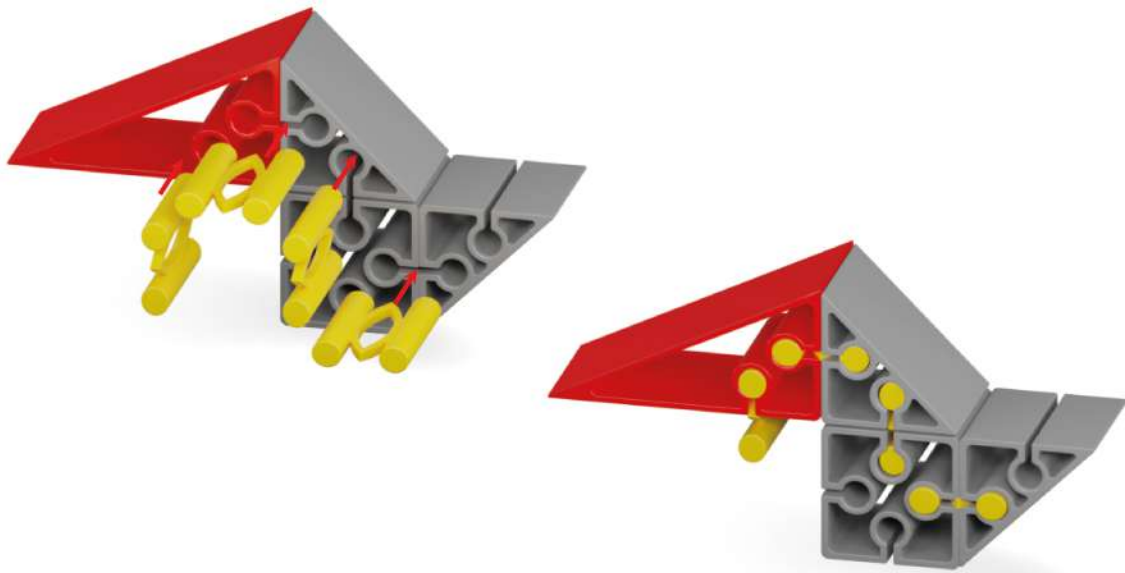

4



	x2		x4
	x1		x1

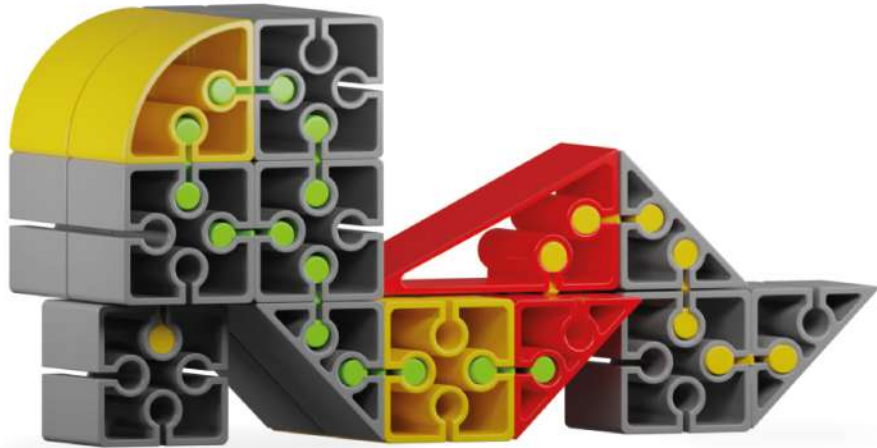
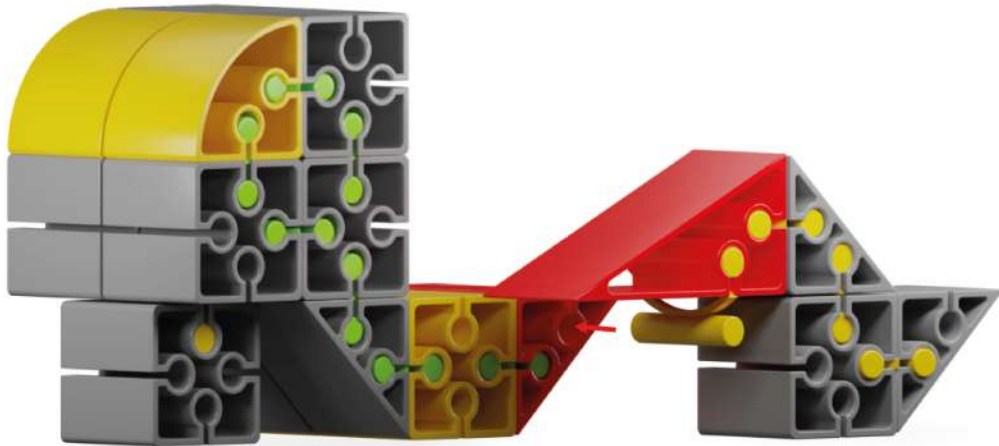



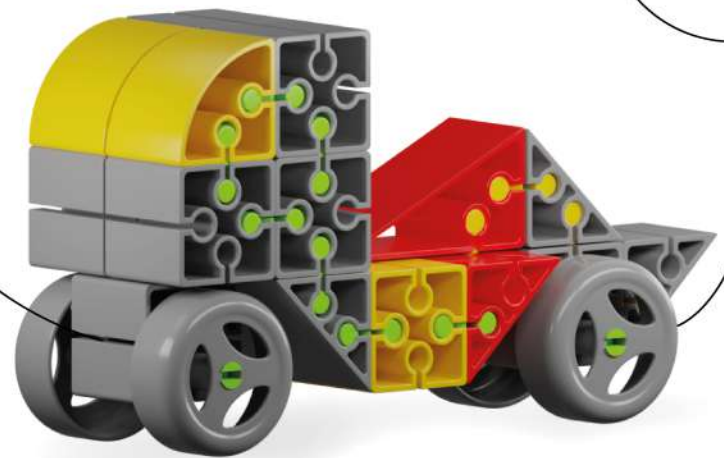
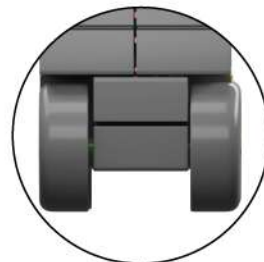
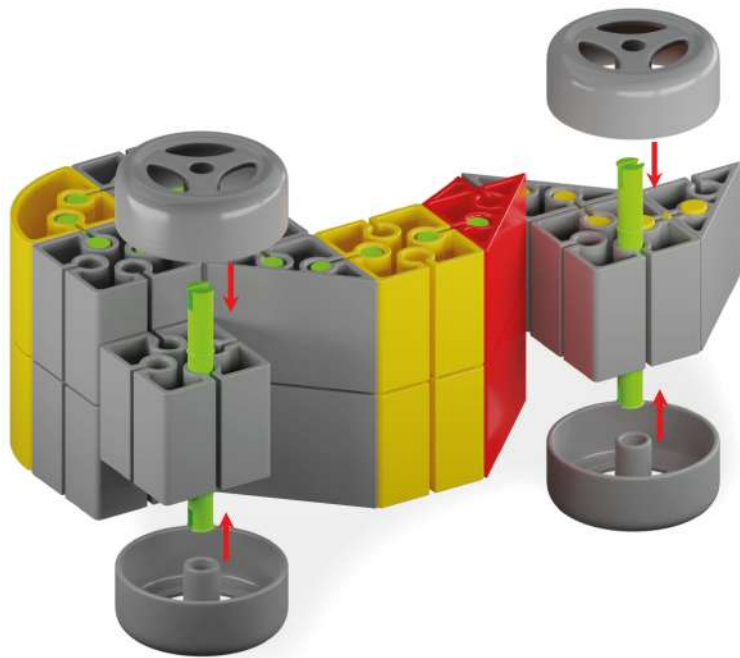
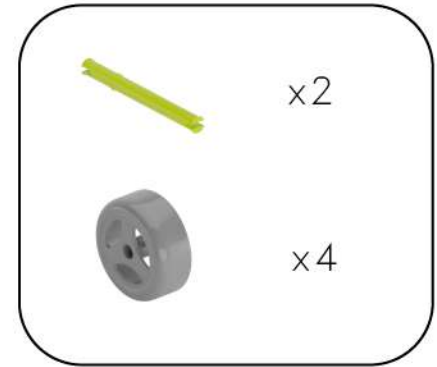
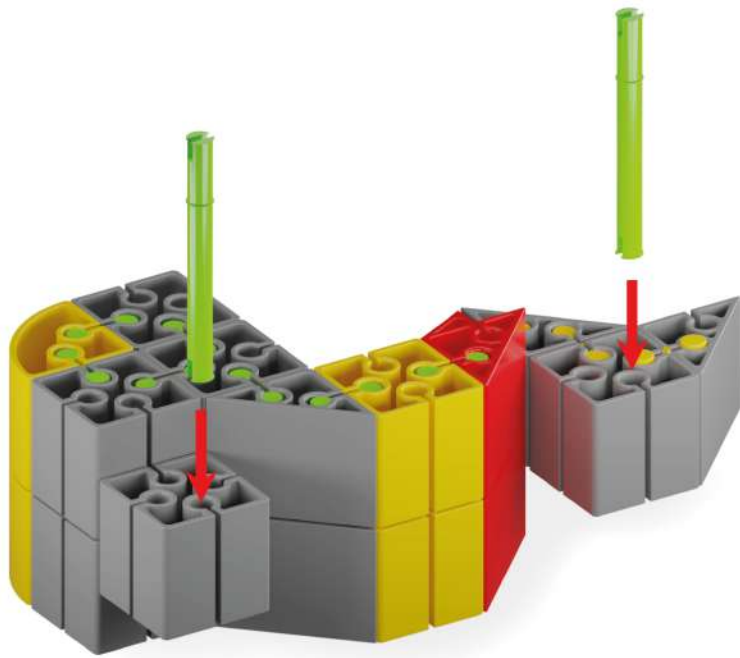



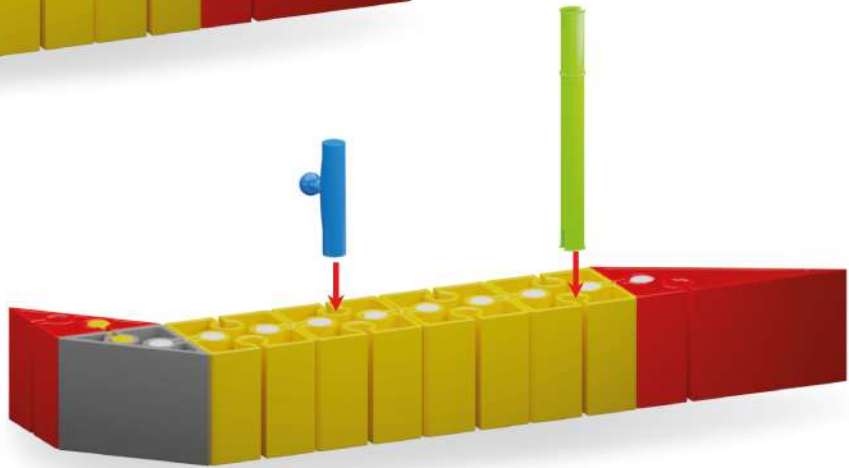
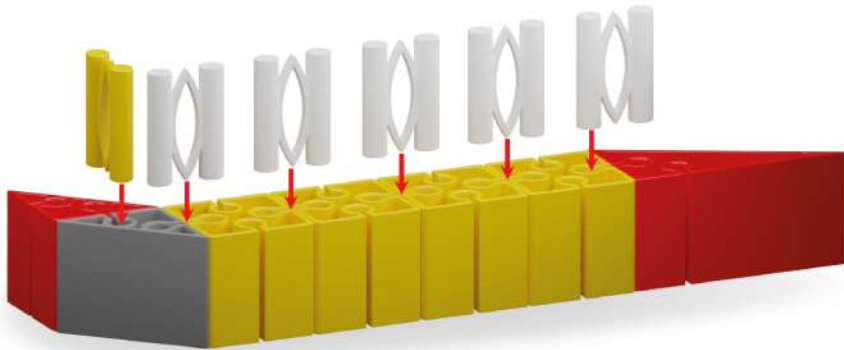

5



6



-  x4
-  x1
-  x1
-  x1
-  x6
-  x1
-  x1
-  x1
-  x2

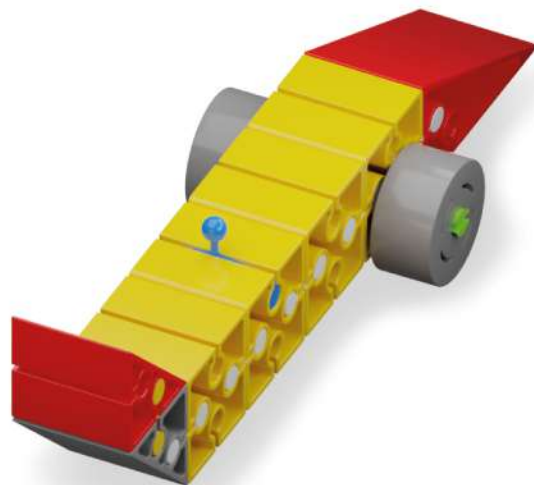
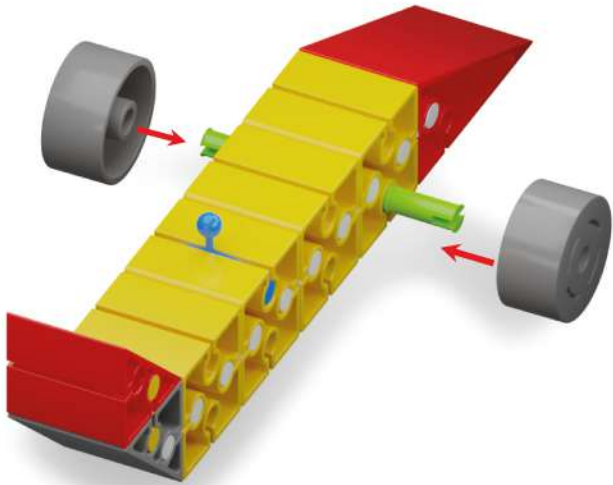

7

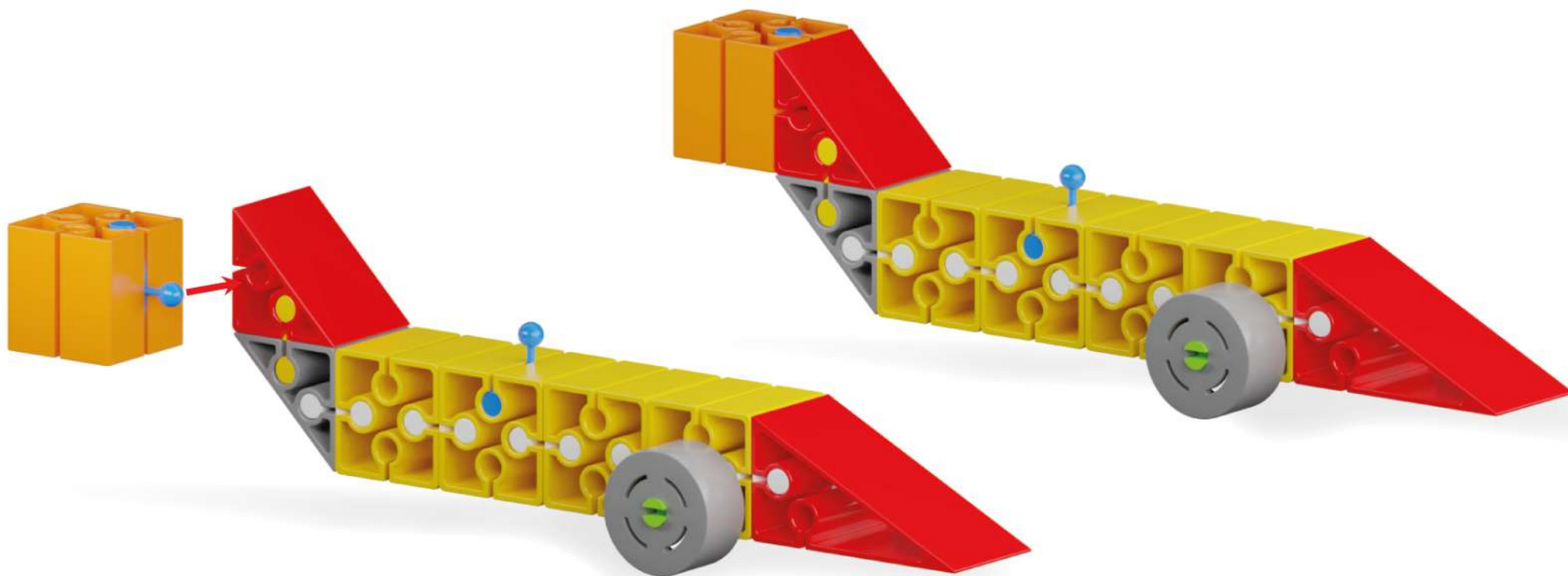
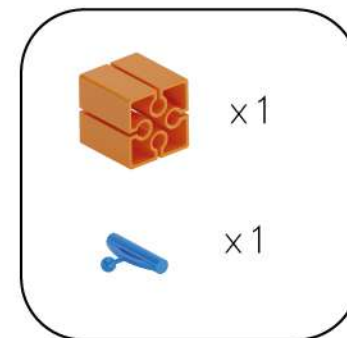
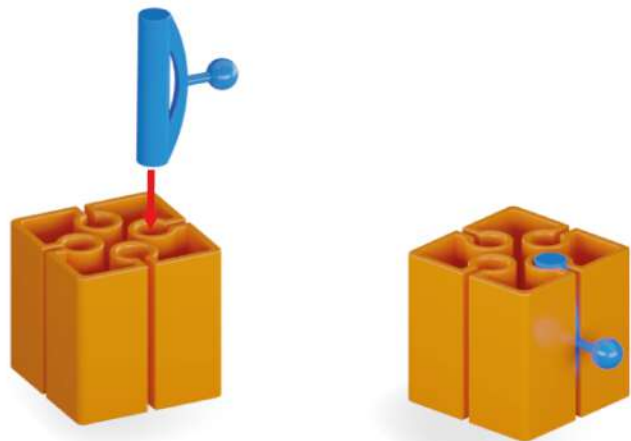

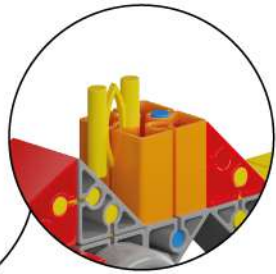
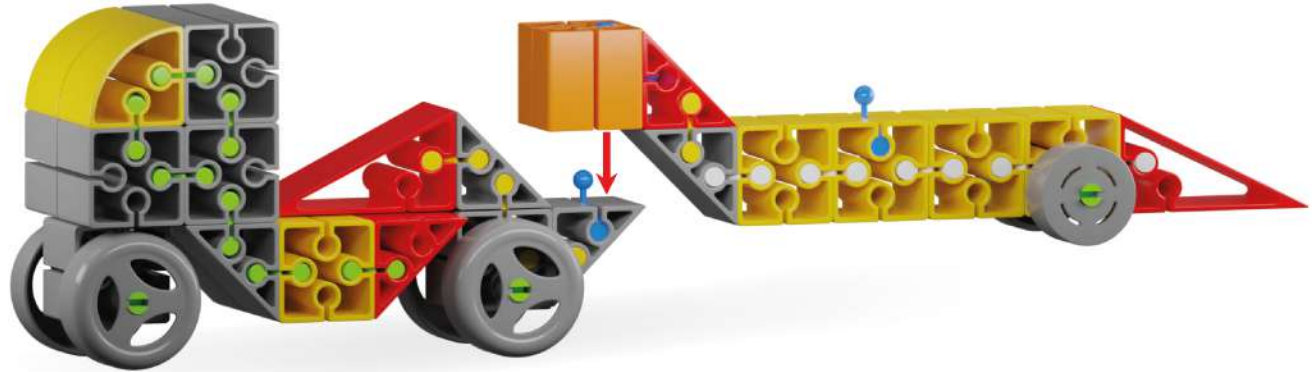
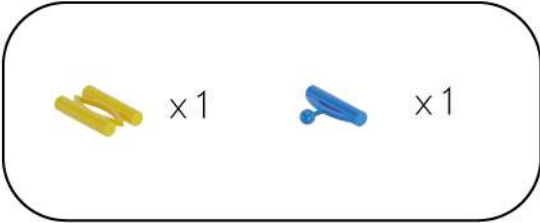

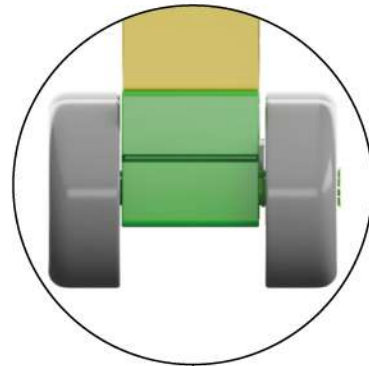
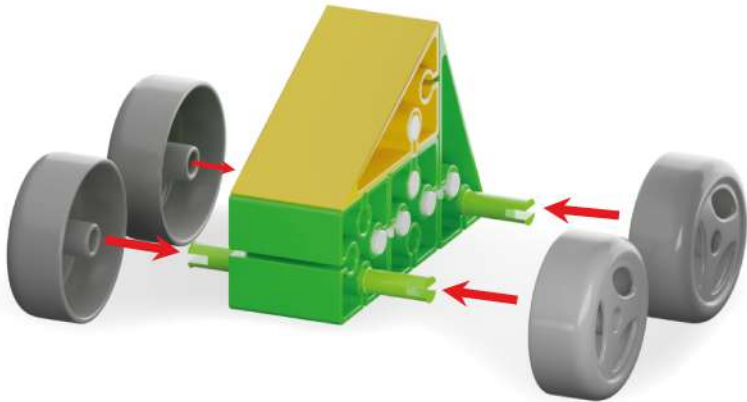
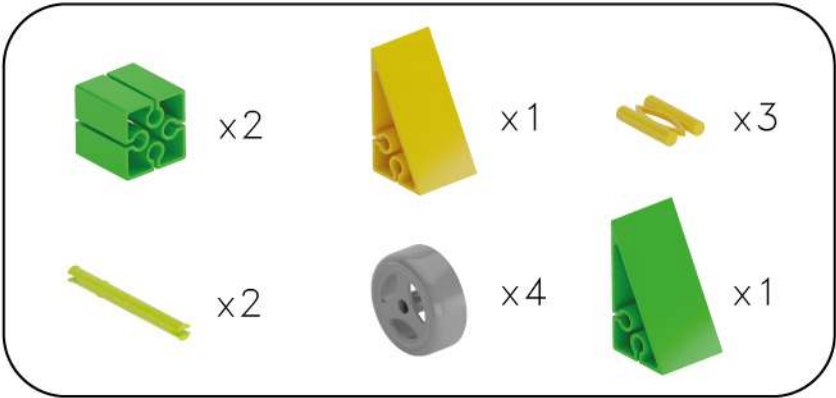
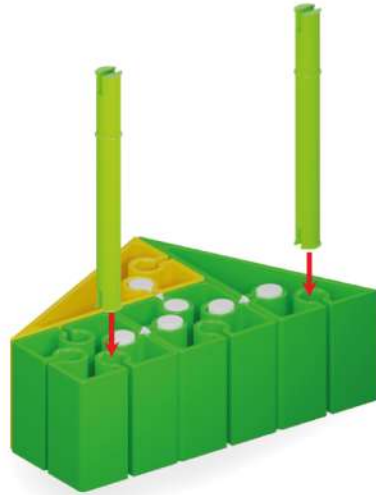
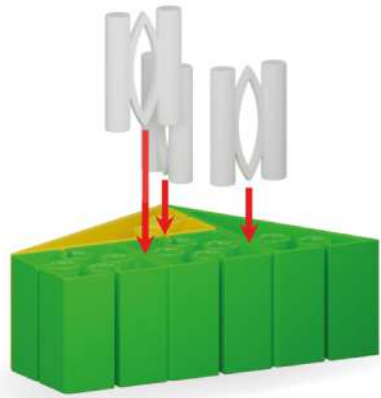



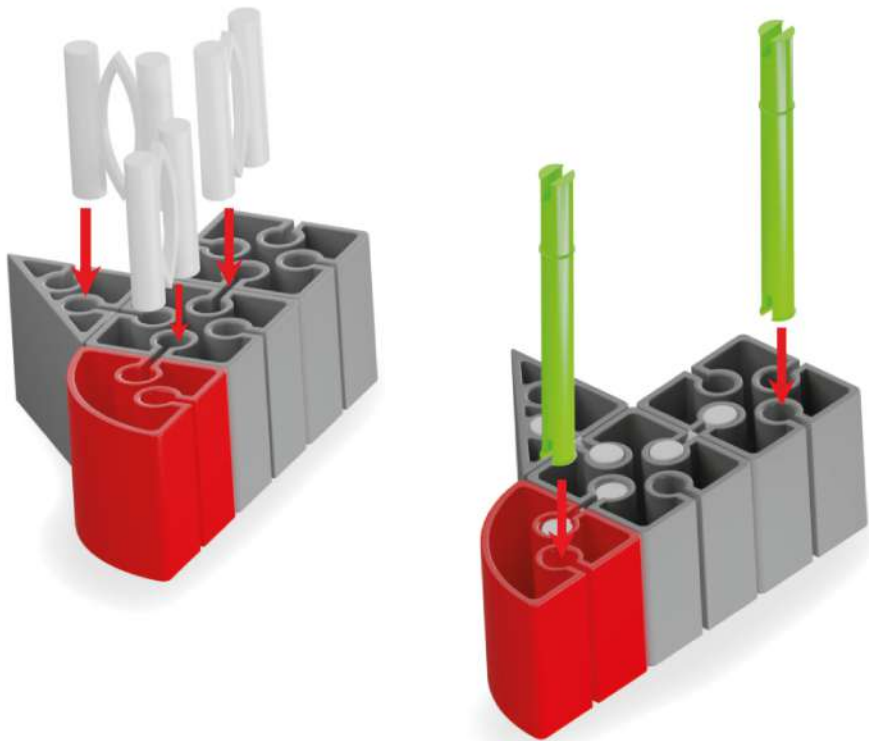



10



-  x2
-  x1
-  x2
-  x1
-  x4
-  x3

