

---

# *The I-7530A-MR Modbus RTU to CAN Converter*

## User's Manual

### Warranty

All products manufactured by ICP DAS are under warranty regarding defective materials for a period of one year from the date of delivery to the original purchaser.

### Warning

ICP DAS assumes no liability for damages resulting from the use of this product. ICP DAS reserves the right to change this manual at any time without notice. The information furnished by ICP DAS is believed to be accurate and reliable. However, no responsibility is assumed by ICP DAS for its use, or for any infringements of patents or other rights of third parties resulting from its use.

### Copyright

Copyright 2016 by ICP DAS. All rights are reserved.

### Trademark

The names used for identification only may be registered trademarks of their respective companies.

---

## Table of Contents

<b>1.</b>	<b>Introduction</b>	<b>4</b>
1.1	<b>Features</b>	6
1.2	<b>Specifications</b>	7
<b>2.</b>	<b>Hardware</b>	<b>9</b>
2.1	<b>Block Diagram</b>	10
2.2	<b>Pin Assignment</b>	11
2.3	<b>Hardware connection</b>	12
2.3.1	CAN port connection	12
2.3.2	Serial port connection	13
2.4	<b>Terminator Resistor Settings</b>	14
2.5	<b>Init / Normal Dip-switch</b>	15
2.5.1	Firmware Update Mode	15
2.5.2	Firmware Operation Mode	17
2.5.3	Module Configuration Mode	18
2.6	<b>LED Indication</b>	18
2.7	<b>Cable Selection</b>	20
<b>3.</b>	<b>Software Utility</b>	<b>21</b>
3.1	<b>Install the UART2CAN Utility</b>	22
3.2	<b>Configure the module parameters</b>	25
3.2.1	Connect to the I-7530A-MR module with UART2CAN Utility	25
3.2.2	Select the communication mode	26
3.2.3	Set the COM port parameters	27
3.2.4	Set the CAN parameters	28
3.2.5	Set the “Pair Connection” parameter	28
3.2.6	Set the “Modbus Slave” parameter	29
3.2.7	Configuration of default value	30
3.2.8	Load/Save the parameter configuration	31
3.3	<b>CAN Filter Configuration</b>	32
3.3.1	Create New CAN Filter	32
3.3.2	Download a existed CAN Filter file	35
3.3.3	Read I-7530A-MR CAN Filter Configuration	36
3.4	<b>Pair-connection Mode Description</b>	37
3.5	<b>Testing the I-7530A-MR module</b>	43
3.5.1	Normal mode	45
3.5.2	Pair Connection Mode	47
3.5.3	Modbus Slave Mode	48
<b>4.</b>	<b>Command list (Only for normal mode)</b>	<b>50</b>

---

4.1	tIIILDD...[CHK]<CR> .....	52
4.2	TIIL[CHK]<CR>.....	52
4.3	eIIIIIIILDD...[CHK]<CR> .....	53
4.4	EIIIIIIIL[CHK]<CR> .....	53
4.5	S[CHK]<CR>.....	54
4.6	P0BBDSPCR[CHK]<CR> .....	55
4.7	P1B [CHK]<CR> .....	58
4.8	P2BBBBB[CHK]<CR>.....	59
4.9	RA[CHK]<CR>.....	60
4.10	General Error code for all command .....	61
<b>5.</b>	<b>Modbus Slave Mode.....</b>	<b>62</b>
5.1	Supported Modbus Functions.....	64
5.2	Modbus Address .....	64
5.2.1	Using Modbus RTU command to get a CAN Message.....	79
5.2.2	Using Modbus RTU command to send a CAN message .....	81
5.2.2.1	Using function Code 10 <sub>hex</sub> to send a CAN message.....	81
5.2.2.2	Using function Code 06 <sub>hex</sub> to send a CAN message.....	83
5.2.3	Using Modbus RTU command to get a Specific CAN Message.....	86
5.2.4	Using Modbus RTU command to configure module .....	87
5.3	Modbus Exception Codes.....	89
<b>6.</b>	<b>Modbus Master Mode .....</b>	<b>90</b>
6.1	Supported Modbus Functions.....	90
6.2	IO Memory Size.....	91
6.3	Configuration and Operation.....	91
6.3.1	Modbus Read Configuration .....	92
6.3.1.1	Modbus Read Command.....	93
6.3.1.2	Response CAN Message Configuration .....	96
6.3.2	Modbus Write Configuration .....	99
6.3.3	Common Configuration.....	103
<b>7.</b>	<b>Troubleshooting.....</b>	<b>106</b>

# 1. Introduction

The I-7530A-MR is helpful for exchanging the data between the RS-232/485/422 devices and the CAN devices. It supports four communication modes: “Normal”, “Modbus Slave”, “Pair connection”, and “Modbus Master” (firmware version v1.11 or later).

In the Normal mode, the I-7530A-MR is designed to unleash the power of CAN bus via RS-232/485/422 communication method. It accurately converts ASCII format messages and CAN messages between RS-232/485/422 and CAN networks. This mode let you to communicate with CAN devices easily from any PC or programmable devices with RS-232/485/422 interface.

In the Modbus Slave mode, it allows a Modbus RTU master to communicate with CAN devices on a CAN network. The following figure shows the application architecture in this mode.

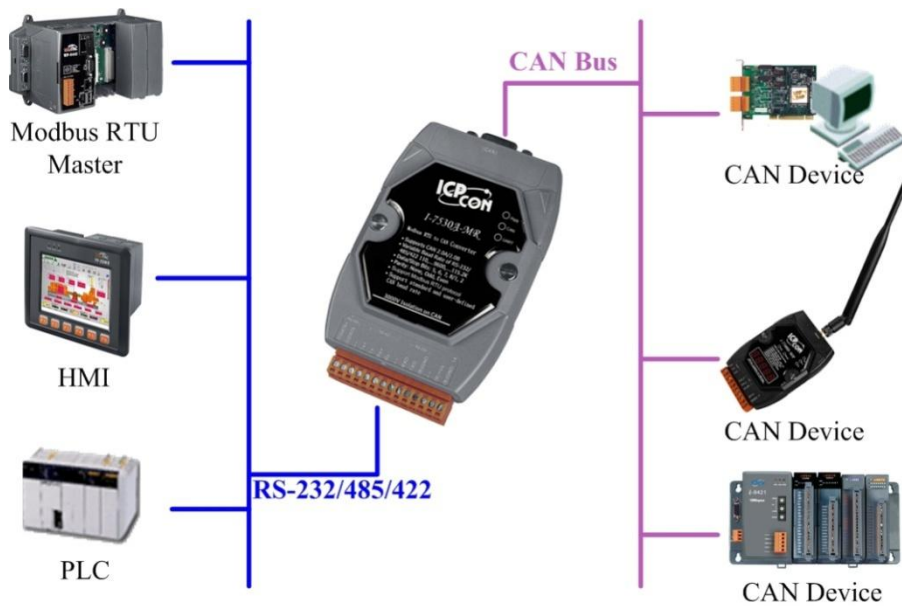

Figure 1-1: The application architecture in the Modbus Slave mode.

In the pair-connection mode, this module provides the transparent communication between the RS-232/485/422 devices via CAN bus. The application architecture may be as follows.



Figure 1-2: The application architecture in the pair-connection mode.

In the Modbus Master mode, it allows many Modbus RTU slaves to communicate with CAN devices on a CAN network. The following figure shows the application architecture in this mode.

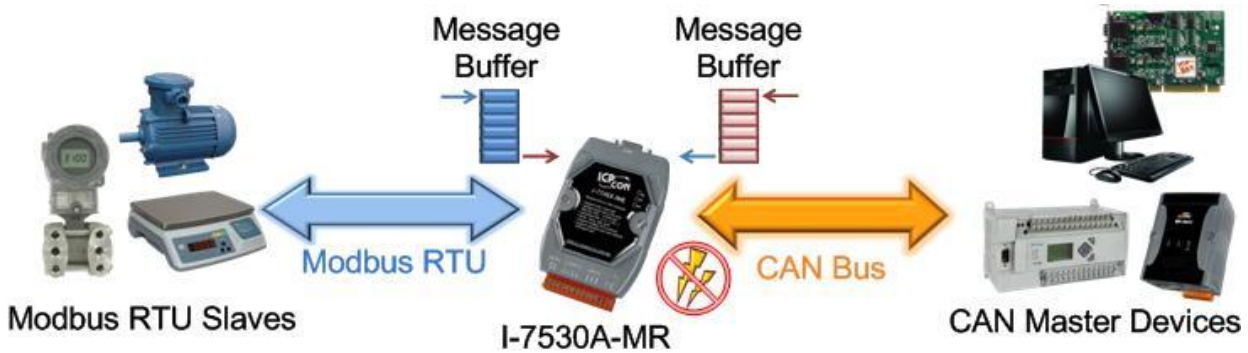

Figure 1-3: The application architecture in the Modbus Master mode.

---

## 1.1 Features

- RoHS Design
- Fully compatible with ISO 11898-2 standard
- Programmable CAN bus baud rate from 10 kbps to 1 Mbps or user-defined baud rate
- Max transmission speed of RS-232/485/422 port up to 230400 bps
- Support CAN bus acceptance filter configuration
- Support firmware update via RS-232
- Utility tool for module configuration and CAN bus communication testing
- Built-in jumper to select 120Ω terminator resistor
- CAN buffer: 128 data frames; UART buffer: 256 bytes.
- Power, data flow and error indicator for CAN and UART status
- Hardware Watchdog design
- Allow special ASCII commands to send and receive CAN messages (Normal mode)
- Provide the transparent communication in the RS-232/485/422 port through the CAN bus (Pair-connection mode)
- In Modbus Slave mode, I-7530A-MR supports function code 0x03, 0x04, 0x06 (firmware version v1.11 or later), and 0x10 of Modbus RTU command for reading or writing CAN message (Modbus Slave mode). Besides, function code 0x10 has additional functions for configuring module.
- Support Modbus Master function (firmware version v1.11 or later).

---

## 1.2 Specifications

### UART specification:

- Connector: 14-pin screw terminal connector
- COM1: RS-232: (TxD, RxD, GND)  
RS-422: (TxD+, TxD-, RxD+, RxD-)  
RS-485: (DATA+, DATA-)
- Baud Rate(bps): 300, 600, 1200, 2400, 4800, 9600, 19200, 38400, 57600, 115200, 230400
- Data/Stop bits: 5, 6, 7, 8 / 1, 2
- Parity bit: None, Odd, Even
- Isolation voltage: 3000 V<sub>DC</sub> power protection and 2500V<sub>rms</sub> photo-couple in the UART side

### CAN specification:

- CAN interface connector: 9-pin male D-sub (CAN\_L, CAN\_H, CAN\_GND, and N/A for others)
- CAN Baud Rate(bps): 10 k, 20 k, 50 k, 100 k, 125 k, 250 k, 500 k, 800 k and 1 M (allow user-defined baud rate)
- Isolation voltage: 3000 V<sub>DC</sub> power protection on CAN side, 3750V<sub>rms</sub> photo-couple on CAN bus
- Terminator Resistor: Jumper for 120Ω terminator resistor
- Support Protocol: ISO-11898-2, CAN 2.0A and CAN 2.0B

### Power requirement:

- Unregulated +10V DC ~ +30V DC
- Power consumption: 1.5W
- DIP switch: Init (Firmware Update, Module Configuration) / Normal (Firmware Operation)

### Module specs:

- Dimensions: 72mm x 118mm x 35mm (W x L x H)
- Operating temperature: -25 to 75°C (-13 to 167°F)
- Storage temperature: -30 to 80°C (-22 to 176°F)
- Humidity: 10 to 95%, non-condensing
- LEDs: PWR LED for power  
CAN LED for CAN bus communication  
UART LED for UART communication

---

**Software Utility tool:**

- CAN bus baud rate configuration
- CAN acceptance filter configuration
- CAN 2.0A or 2.0B specific selection
- RS-232/485/422 baud rate and data format configuration
- Checksum function selection of the RS-232/485/422 communication
- Communication mode setting
- Function for transmitting or receiving CAN messages

**Application:**

- Factory Automation
- Building Automation
- Home Automation
- Control system
- Monitor system
- Vehicle Automation



## 2. Hardware

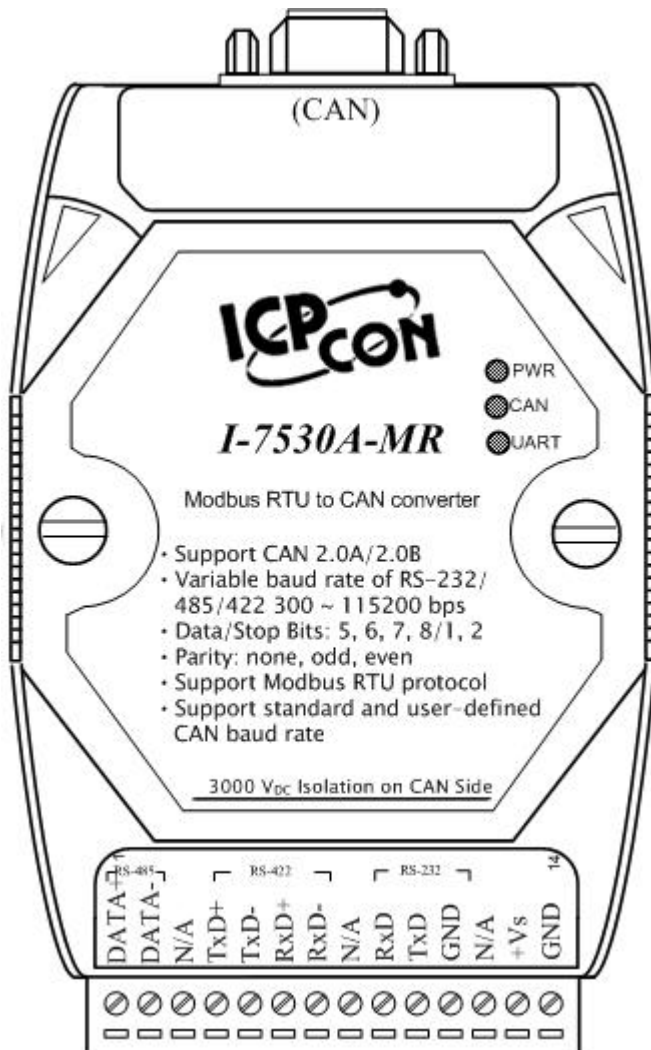

Figure 2-1: Hardware profile of the I-7530A-MR

## 2.1 Block Diagram

Figure 2-2 is a block diagram illustrating the functions of the I-7530A-MR module. It provides the 3000V<sub>DC</sub> Isolation in the CAN and UART interface. And hardware media in RS-232 interface only adopts 3-wire connection.

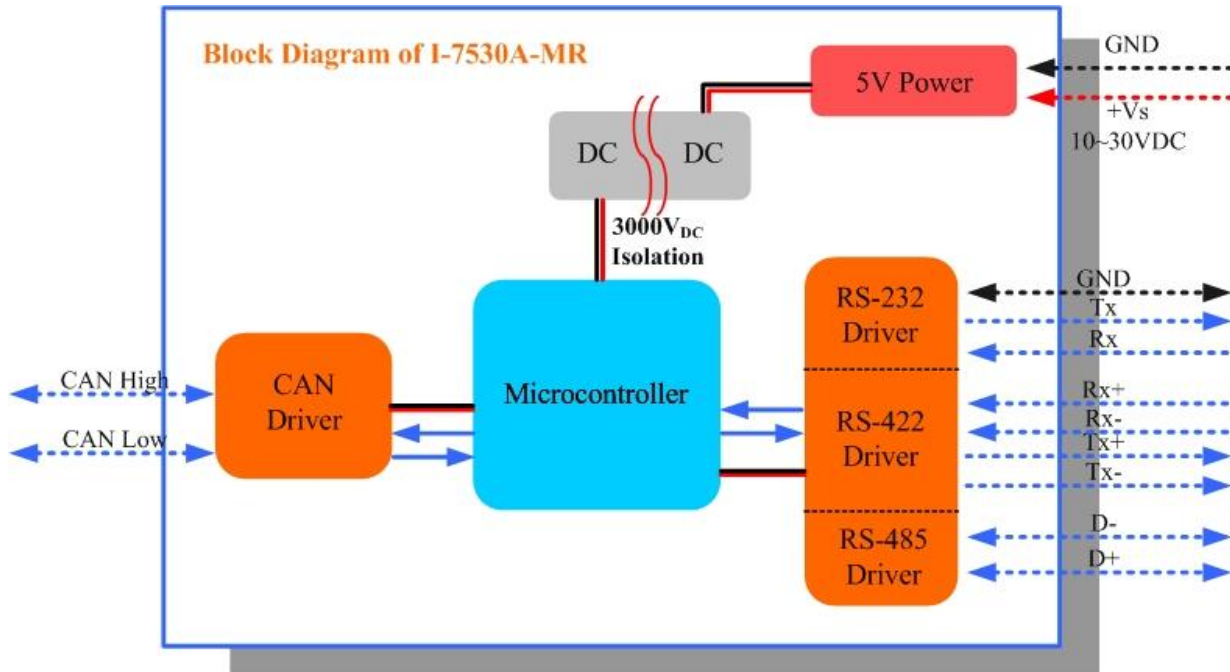
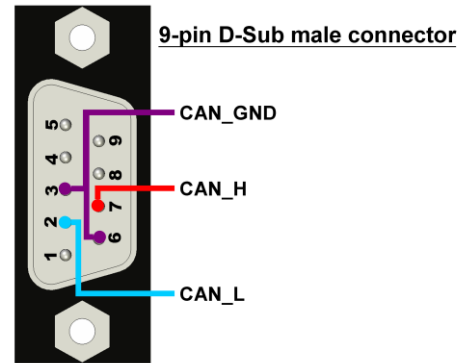

Figure 2-2: Block diagram of I-7530A-MR

## 2.2 Pin Assignment

Table 2-1: CAN DB9 Male Connector

Pin	Description
1	Not Connect
2	<b>CAN Low</b>
3	<b>CAN Ground</b>
4	Not Connect
5	
6	<b>CAN Ground</b>
7	<b>CAN High</b>
8	Not Connect
9	



Pin	Description
1	RS-485 DATA+
2	RS-485 DATA-
3	No use
4	RS-422 TxD+
5	RS-422 TxD-
6	RS-422 RxD+
7	RS-422 RxD-
8	No use
9	RS-232 RXD
10	RS-232 TXD
11	RS-232 GND
12	No use
13	+Vs(+10 ~ +30 VDC)
14	GND

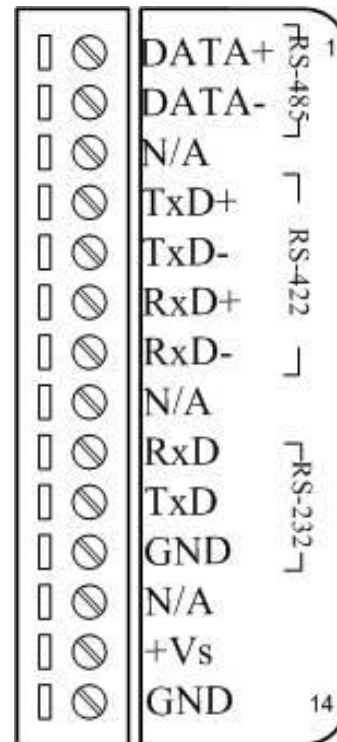

Figure 2-3: Pin Assignment on the I-7530A-MR

## 2.3 Hardware connection

The I-7530A-MR module supports CAN/Serial port communication, it offers one CAN interface for CAN network and RS-232/485/422 interfaces for serial communication.

### 2.3.1 CAN port connection

The pin assignment of the CAN port of the I-7530A-MR (DB9 male) is defined in both the CANopen DS102 profile and in appendix C of the DeviceNet specifications. It is the standard pin assignment for CAN interface. The hardware connection between the target device and the I-7530A-MR is shown as Figure 2-4.

## CAN Devices Wire Connection

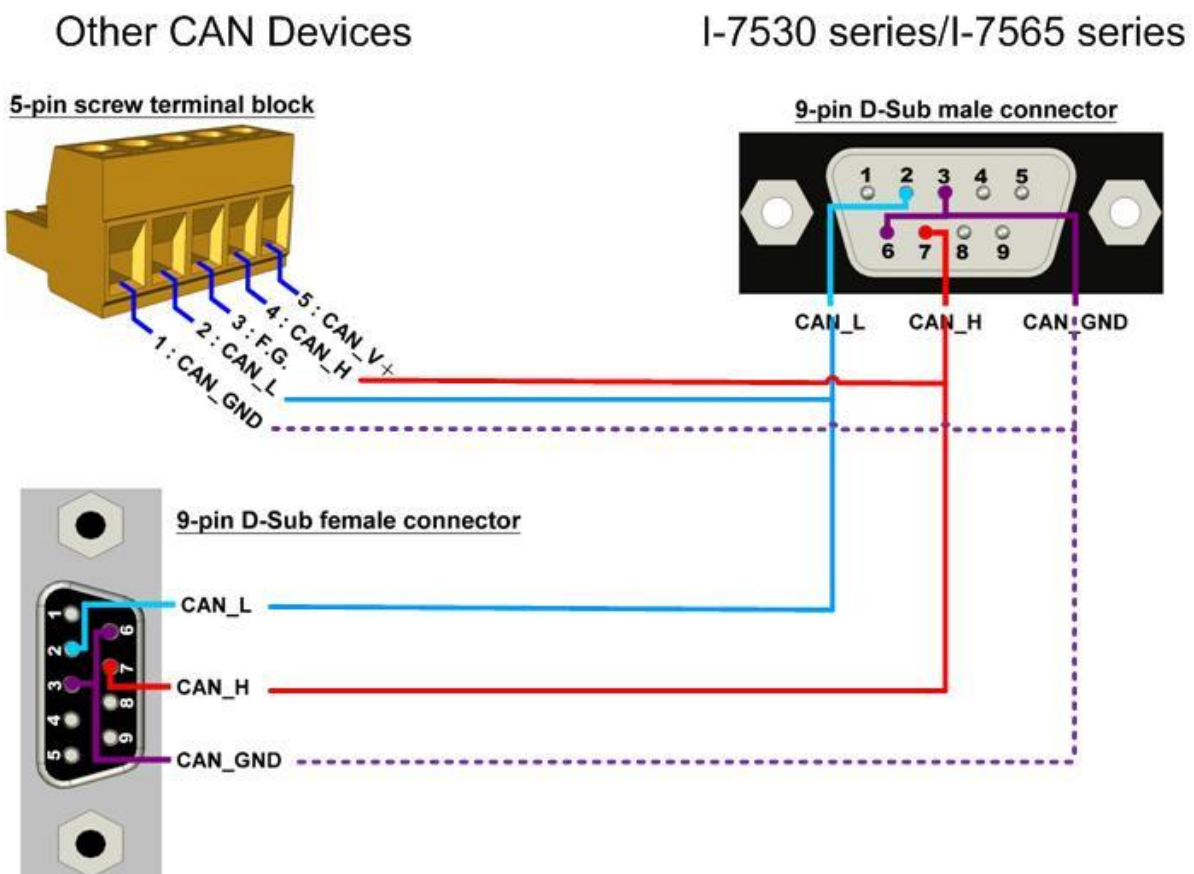

Note:

I-7530 series include I-7530, I-7530T, I-7530-FT, I-7530A, and I-7530A-MR.

I-7565 series include I-7565, and I-7565-H1.

tM-7565 and I-7565-H2 use different CAN connectors.

Figure 2-4: CAN Hardware Wire Connection

### 2.3.2 Serial port connection

The I-7530A-MR offers three serial interfaces. It is recommended to use only one of them at the same time. The following figures describe these port types and the wiring method for a serial device.

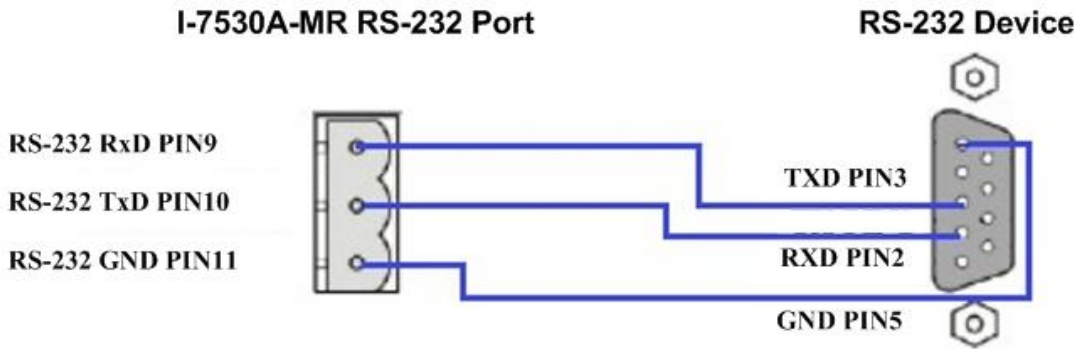

Figure 2-5: RS-232 Wire Connection

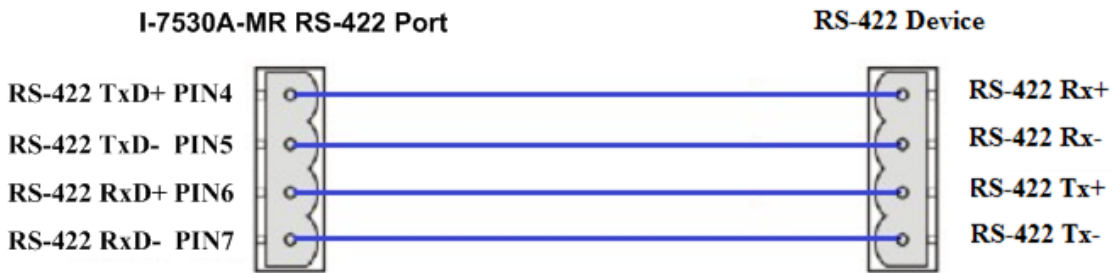

Figure 2-6: RS-422 Wire Connection

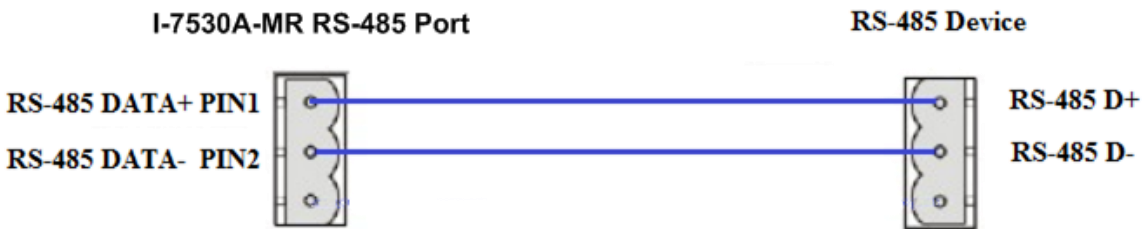

Figure 2-7: RS-485 Wire Connection

## 2.4 Terminator Resistor Settings

According to the ISO 11898 specifications, the CAN Bus network must be terminated by two terminal resistors ( $120\Omega$ ). They are shown as following figure.

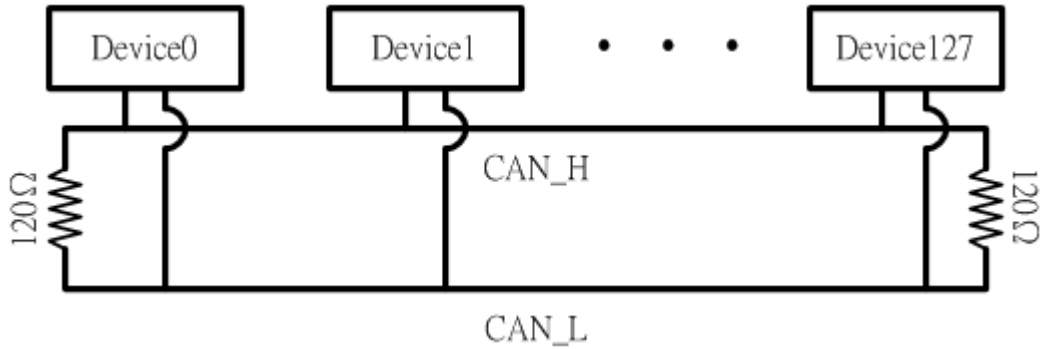

Figure 2-8: Terminal Resistor

Therefore, the I-7530A-MR module supplies a jumper for activating the terminal resistor. If users want to use this terminal resistor, please open the I-7530A-MR cover and use the JP3 to activate the  $120\Omega$  terminal resistor built in the module, as the Figure 2-9. Note that the default setting is active.

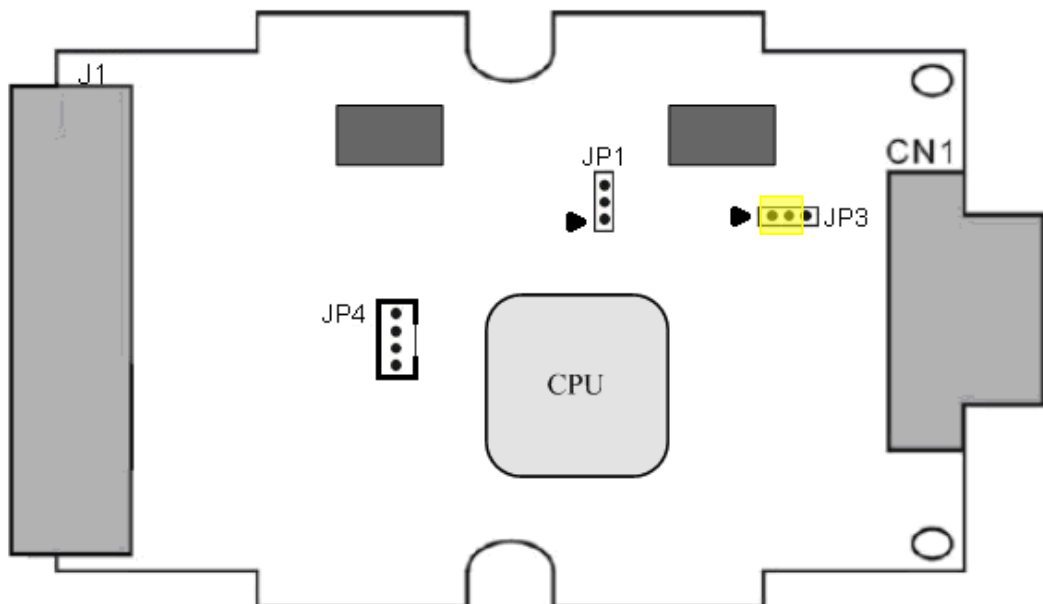

Figure 2-9: Terminal Resistor Jumper

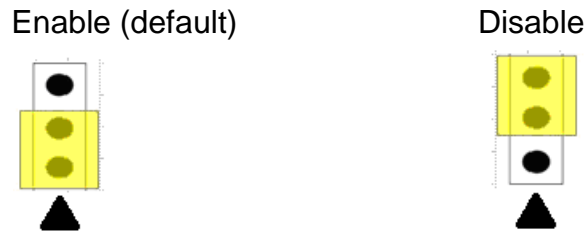

Figure 2-10: Terminal resistor JP3 Jumper Position

## 2.5 Init / Normal Dip-switch

On the back of the I-7530A-MR module, there is a DIP-switch used to configure the “firmware operation mode”, “firmware update mode” or “module configuration mode”. The following steps show how to use it.

### 2.5.1 Firmware Update Mode

Please set the DIP-switch to the “Init” (Initial) position as Figure 2-12, and then the I-7530A-MR will work in the “Firmware Update Mode” after resetting the power of the module. In the firmware update mode, users can update the firmware of the I-7530A-MR module from computer’s RS-232 port via CA-0910 cable, as Figure 2-12~2-14.

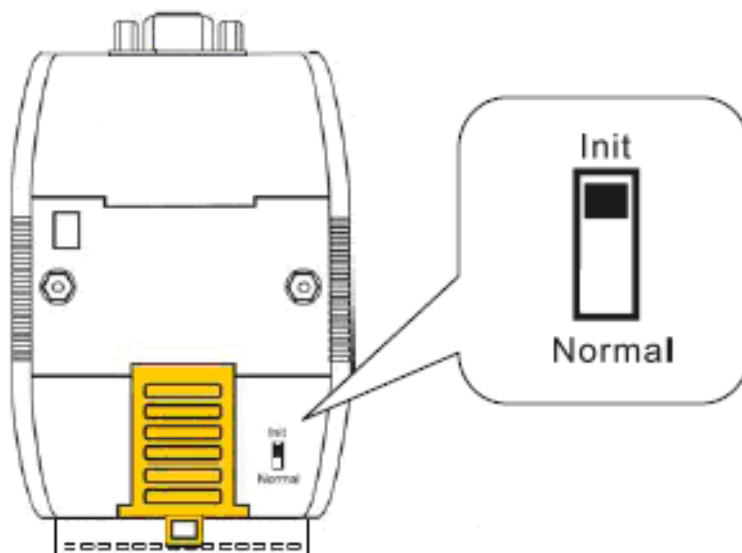

Figure 2-12: Init Position of DIP-Switch



Figure 2-13: CA-0910 Cable

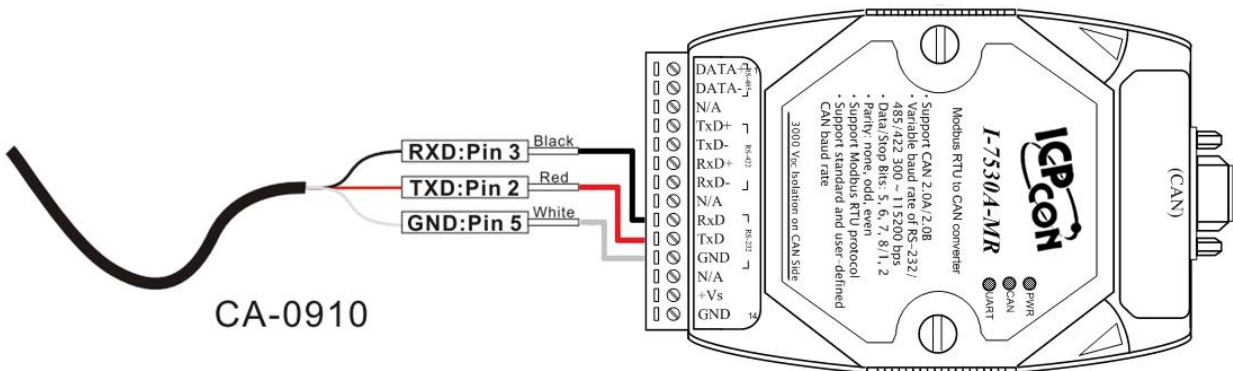

Figure 2-14: Firmware downloads connection

While updating the firmware, users need to execute “Firmware\_Update\_Tool.exe”. The following steps show the update procedure.

- [1] Run the Firmware\_Update\_Tool.exe.
- [2] Choose “**COM**” interface and “**COM Port**”.
- [2] Click “**Browser**” button to choose the firmware file.  
(e.g. **I7530AMR\_100.fw**)
- [3] Click “**Firmware Update**” button to start firmware update process.



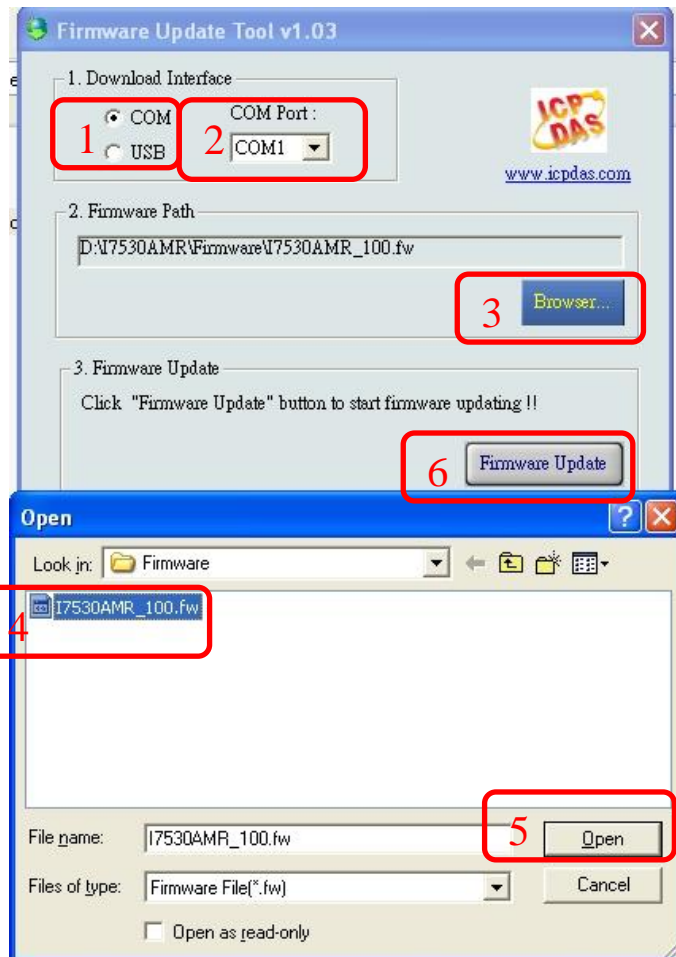

Figure 2-15: I-7530A-MR firmware update process

The I-7530A-MR firmware can be downloaded from [http://ftp.icpdas.com/pub/cd/fieldbus\\_cd/can/converter/i-7530a-mr/firmware/](http://ftp.icpdas.com/pub/cd/fieldbus_cd/can/converter/i-7530a-mr/firmware/)

The “Firmware\_Update\_Tool” program can be downloaded from [http://ftp.icpdas.com/pub/cd/fieldbus\\_cd/can/converter/i-7530a-mr/utility/](http://ftp.icpdas.com/pub/cd/fieldbus_cd/can/converter/i-7530a-mr/utility/)

### 2.5.2 Firmware Operation Mode

Please set the DIP-switch to the “Normal” position as Figure 2-16 and power on the I-7530A-MR module. The module’s PWR LED always turned on and the others LEDs are turned off. That means the I-7530A-MR module is working in the operation mode. In this mode, users can use the RS-232/485/422 device to send/receive CAN messages via COM port.

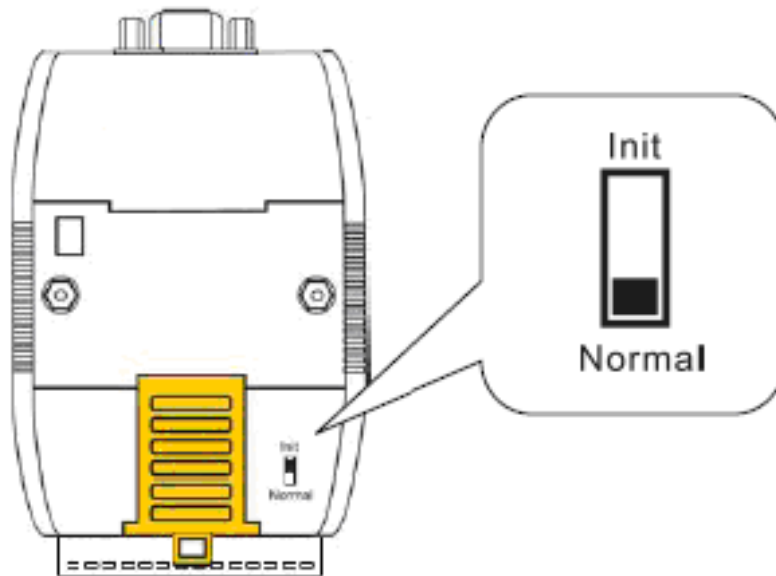

Figure 2-16: Normal Position of Dip-Switch

### 2.5.3 Module Configuration Mode

During the module is running in the Firmware Operation Mode, set the DIP-switch to the “Init” (Initial) position as Figure 2-12 and wait for three seconds. The module’s PWR LED still turns on and the others LEDs will flash approximately once per second. That means the I-7530A-MR module is working in the “Module Configuration Mode”. In this mode, users can use UART2CAN Utility to configure the communication parameters and communication modes of the module.

## 2.6 LED Indication

There are three LEDs to indicate what the state of the I-7530A-MR is in. The positions of these three LEDs are shown as Figure 2-17.

### (1) PWR LED :

It is used to help users with checking if the I-7530A-MR is standby. If the module is supplied the proper power, the PWR LED is turned on. The different situations of the module may cause the different blinking display. The PWR LED is always turned on when the module works in a good condition. When the Bus-Off error is happened, the PWR LED will blink every 500 ms until the Bus-Off condition disappears. If the CAN message can’t be sent out successfully, the PWR LED will blink every 100 ms.

**(2) CAN LED :**

It is used to show whether the I-7530A-MR is transmitting/receiving CAN messages. The CAN LED will blink whenever a CAN message is sending or receiving.

**(3) UART LED :**

It is used to show whether the I-7530A-MR is transmitting/receiving COM messages. The UART LED will blink whenever a COM message is sending or receiving.

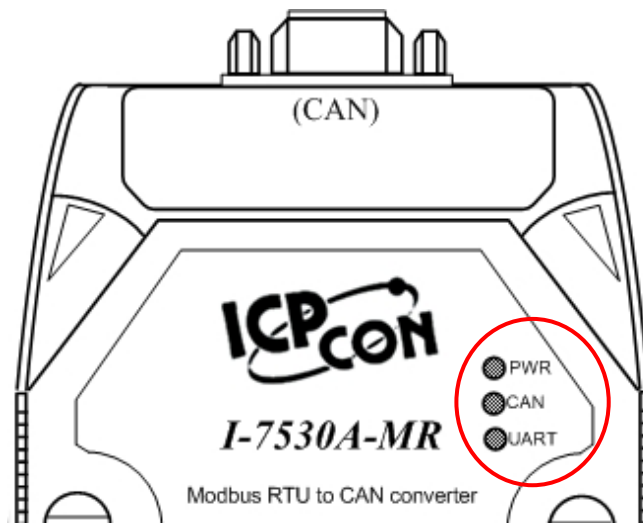

Figure 2-17: LED position of the I-7530A-MR

Table 2-3: LED indication of the I-7530A-MR

LED Name	I-7530A-MR Status	LED Status
ALL LEDs	Firmware Updating Mode	All LED always turned on
	Module Configuration Mode	PWR LED always be turned on and the other LEDs blink every 1000 ms
PWR LED	No Error	Always turned on
	CAN Bus Transmission Fail	Blink every 100 ms
	CAN Bus-Off	Blink every 500 ms
	Power Failure	Off
CAN LED	Transmission	Blink
	Bus Idle	Off
UART LED	Transmission	Blink
	Bus Idle	Off

## 2.7 Cable Selection

The CAN bus is a balanced (differential) 2-wire interface running over either a Shielded Twisted Pair (STP), Un-shielded Twisted Pair (UTP), or Ribbon cable. The CAN-L and CAN-H Wire start on one end of the total CAN network that a terminator of 120 Ohm is connected between CAN-L and CAN-H. The cable is connected from CAN node to CAN node, normally without or with short T connections. On the other end of the cable again a 120Ω(Ohm) terminator resistor is connected between the CAN lines. How to decide a cable type, cable length, and terminator depends on the baud rate in the CAN bus network, please refer to the following table 2-4.



Figure 2-18: Un-shielded Twisted Pair (UTP)

Table 2-4: Cable selection

Bus speed	Cable type	Cable Resistance/m	Terminator	Bus Length
50k bit/s at 1000m	0.75~0.8mm <sup>2</sup> 18AWG	70 mOhm	150~300 Ohm	600~1000m
100k bit/s at 500m	0.5~0.6 mm <sup>2</sup> 20AWG	< 60 mOhm	150~300 Ohm	300~600m
500k bit/s at 100m	0.34~0.6mm <sup>2</sup> 22AWG, 20AWG	< 40 mOhm	127 Ohm	40~300m
1000k bit/s at 40m	0.25~0.34mm <sup>2</sup> 23AWG, 22AWG	< 40 mOhm	124 Ohm	0~40m

**Note:** The AWG means a standard method used to measure wire. The numbering system works backwards from what people would think, the thicker (heavier) the wire, the lower the number. For example: a 24AWG wire is thicker/heavier than a 26AWG wire.

### 3. Software Utility

The UART2CAN Utility tool can be used to configure the operational conditions of the I-7530A-MR between the CAN and RS-232/485/422 communications. It also can be used to transmit or receive a CAN message for simple testing. To start the “UART2CAN Utility”, please install the UART2CAN Utility setup file and run the UART2CAN\_Utility.exe file. The screenshot of the configuration and testing screen are given in the below figure. The next section will show you how to configure the I-7530A-MR and test it by using UART2CAN Utility.

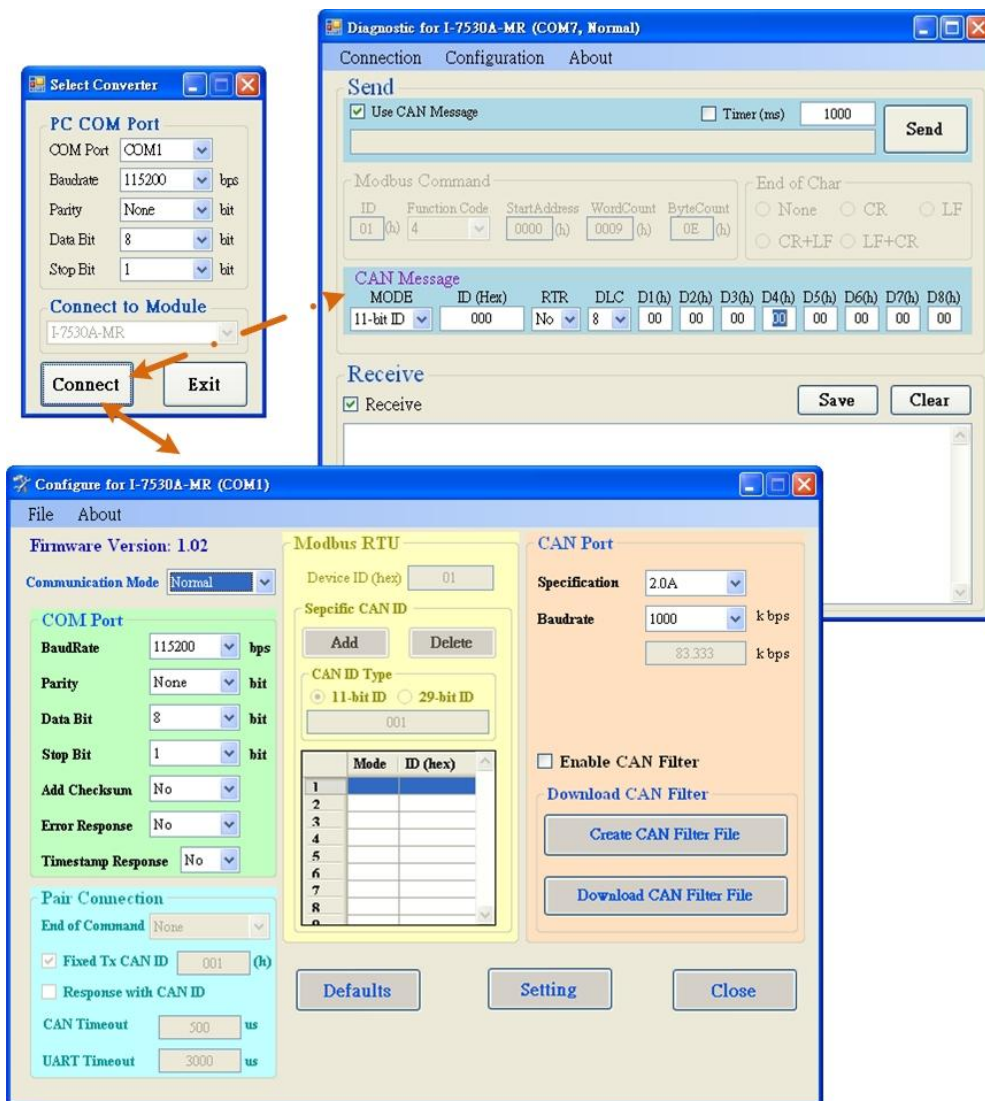

Figure 3-1: Configuration and testing screen for UART2CAN Utility.

### 3.1 Install the UART2CAN Utility

#### Step 1: Get the UART2CAN Utility

The software is located at:

[Fieldbus\\_CD:\CAN\Converter\I-7530A-MR\Utility](http://ftp.icpdas.com/pub/cd/fieldbus_cd/can/converter/i-7530a-mr/utility/)

[http://ftp.icpdas.com/pub/cd/fieldbus\\_cd/can/converter/i-7530a-mr/utility/](http://ftp.icpdas.com/pub/cd/fieldbus_cd/can/converter/i-7530a-mr/utility/)

#### Step 2: Install .NET Framework 4 Client Profile component

The UART2CAN Utility tool requires the Windows Installer 3.1 and the .NET Framework 4 Client Profile components. These components can be obtained from the web site.

Windows Installer 3.1:

[http://ftp.icpdas.com/pub/cd/fieldbus\\_cd/can/converter/i-7530a-mr/utility/windowsinstaller3\\_1/](http://ftp.icpdas.com/pub/cd/fieldbus_cd/can/converter/i-7530a-mr/utility/windowsinstaller3_1/)

.NET Framework 4 Client Profile:

[http://ftp.icpdas.com/pub/cd/fieldbus\\_cd/can/converter/i-7530a-mr/utility/dotnetfx40client/](http://ftp.icpdas.com/pub/cd/fieldbus_cd/can/converter/i-7530a-mr/utility/dotnetfx40client/)

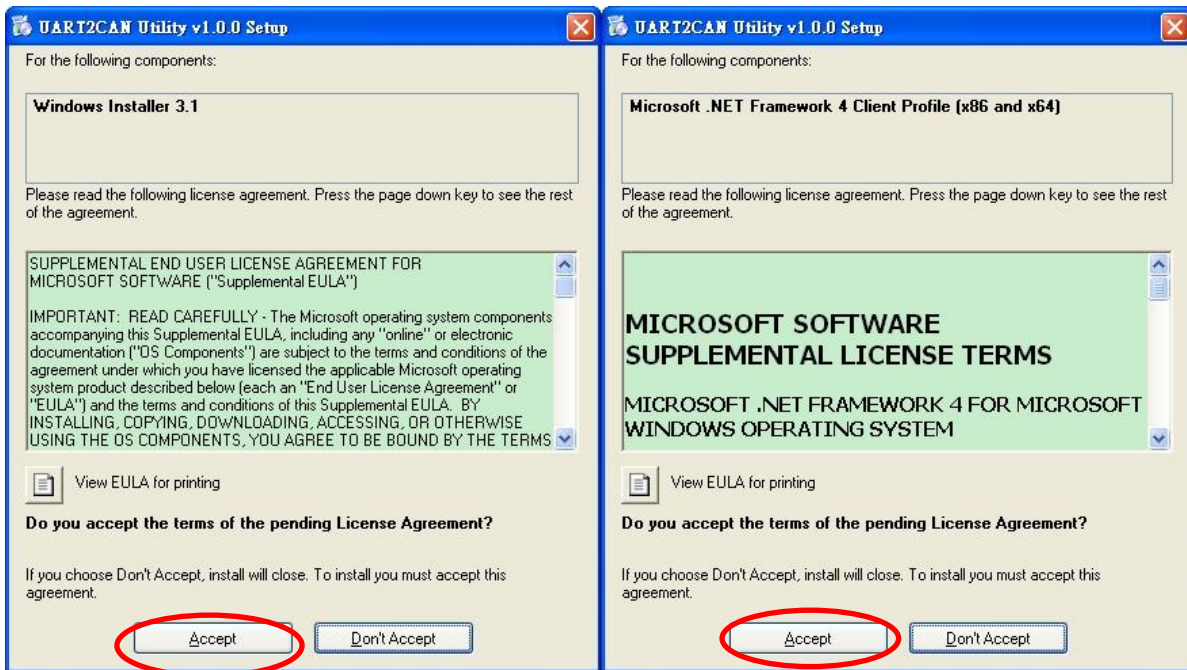

Figure 3-2: Setup the Windows Installer and .NET Framework.



---

### Step 3: Install Utility tool

After installing the .Net Framework components, please run the UART2CAN Utility setup file.

1. Click the “Next” button to continue.

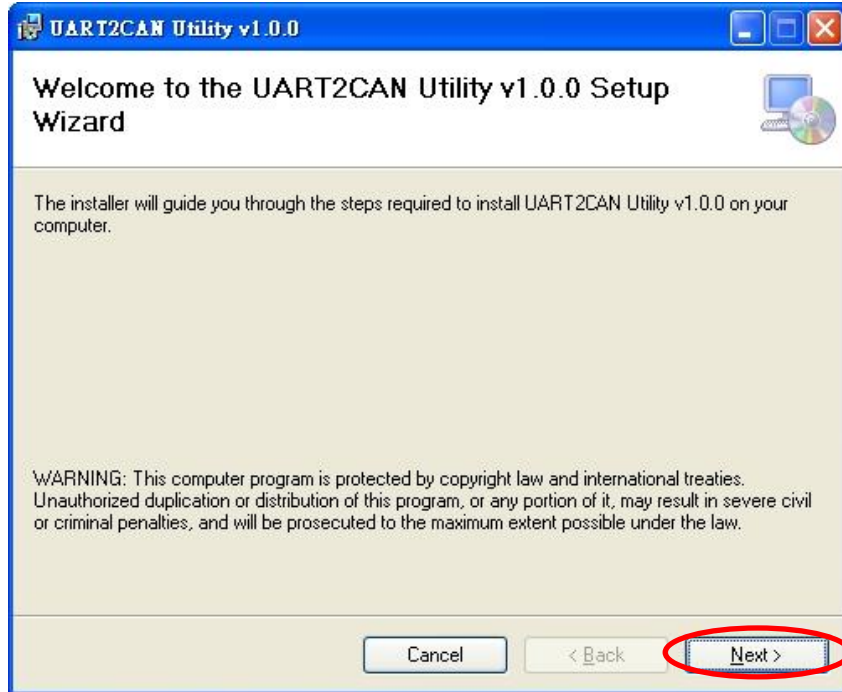

Figure 3-3: Setup the UART2CAN Utility.

2. Select the installation path of the UART2CAN Utility and click the “Next” button.

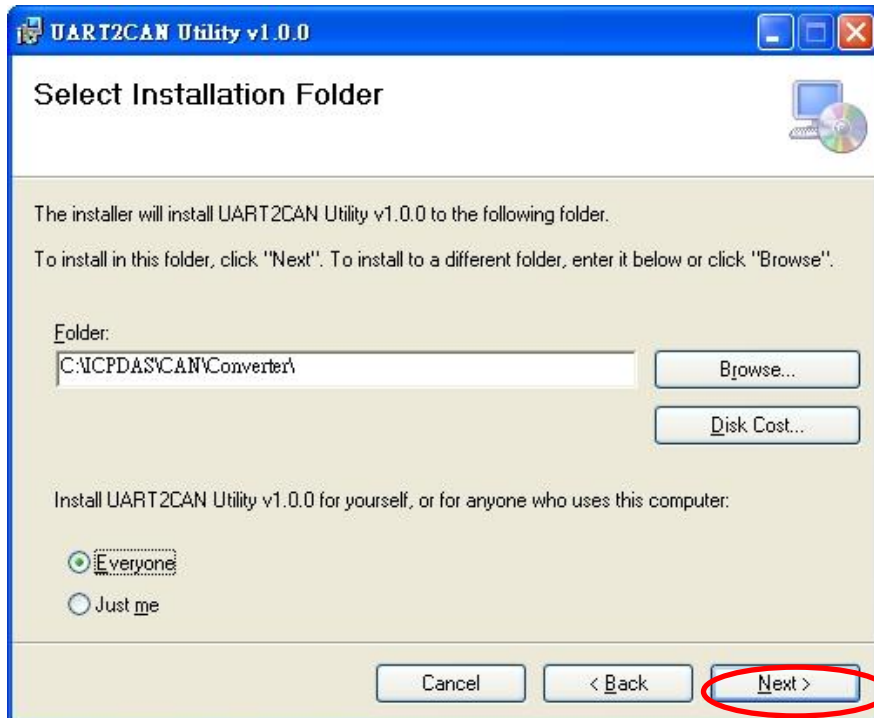

Figure 3-4: Select Installation Folder.

3. Confirm the installation. Click the “Next” button to start the installation.

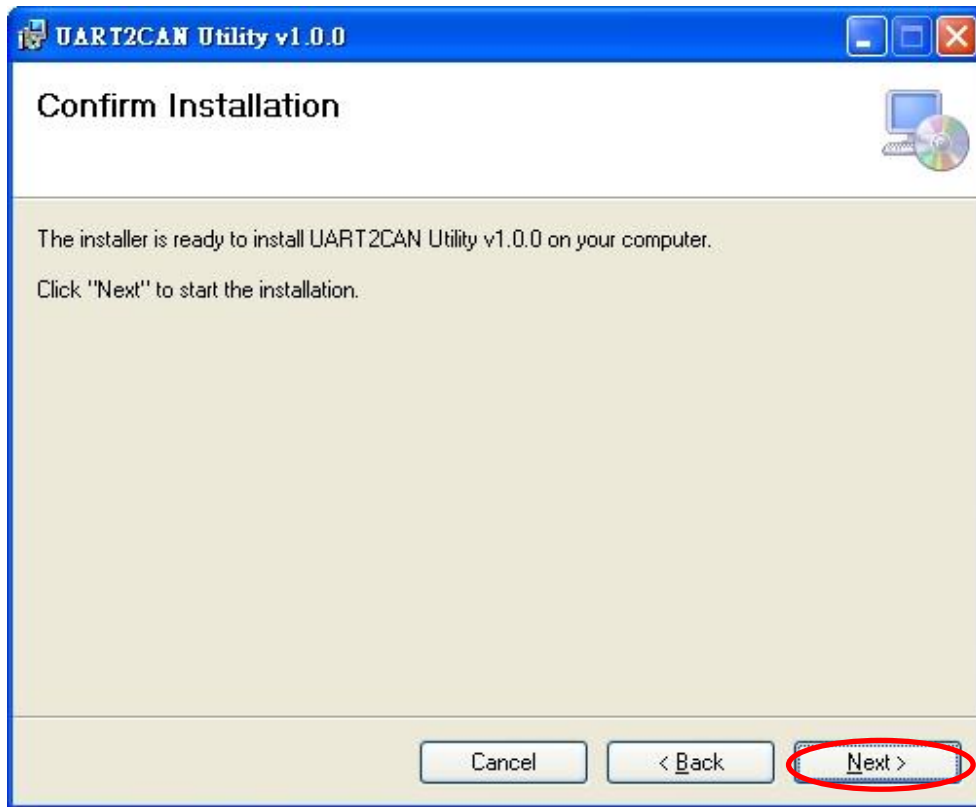

Figure 3-5: Confirm Installation.

4. Installation complete. Click the “Close” button to exit.

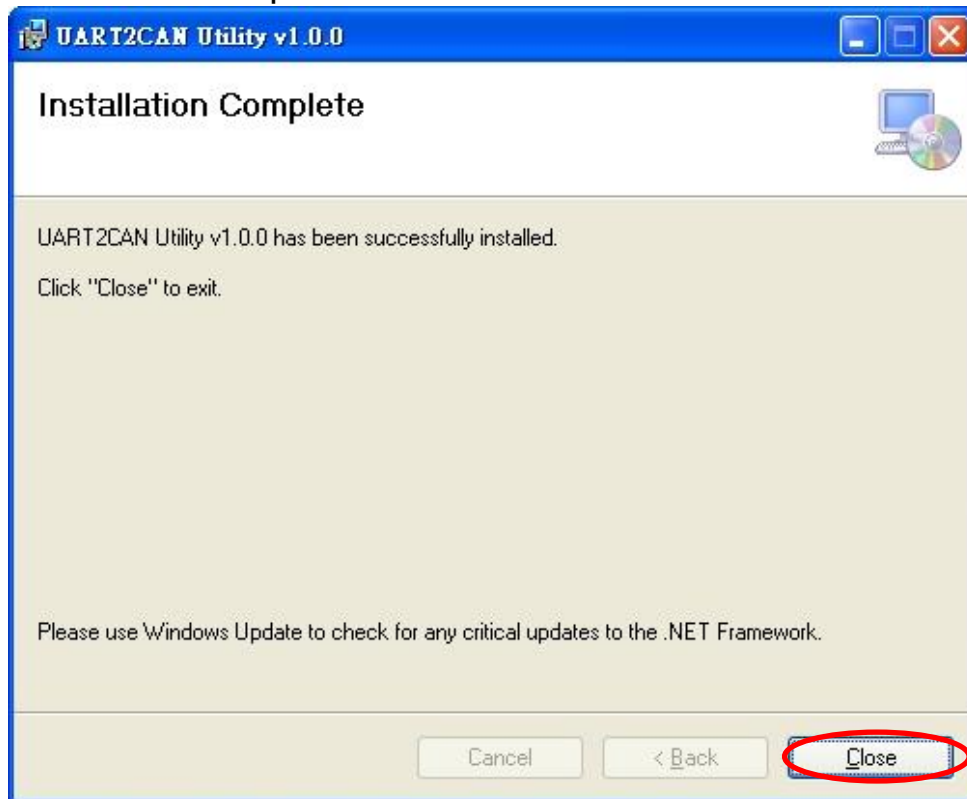

Figure 3-6: Installation complete.



## 3.2 Configure the module parameters

In this section, we will describe how to configure the communication parameters of the I-7530A-MR module with the UART2CAN Utility.

### 3.2.1 Connect to the I-7530A-MR module with UART2CAN Utility

1. Set the Init/Normal switch to the “Normal” position, which is found on the back of the I-7530A-MR module.
2. Supply the proper electric power (the 10~30 DC volts) to the I-7530A-MR module.
3. Set the Init/Normal switch to the “Init” (Initial) position at least three seconds.
4. The PWR LED of the I-7530A-MR module will be turned on and the other LEDs will flash approximately once per second. That means the I-7530A-MR module is working in the configuration mode.
5. Run the UART2CAN Utility software after connecting the PC COM port and the I-7530A-MR RS-232 port by the cable CA-0910.
6. Select the necessary PC COM port to connect with the I-7530A-MR, as shown in the following figure. Then click the “Connect” button.

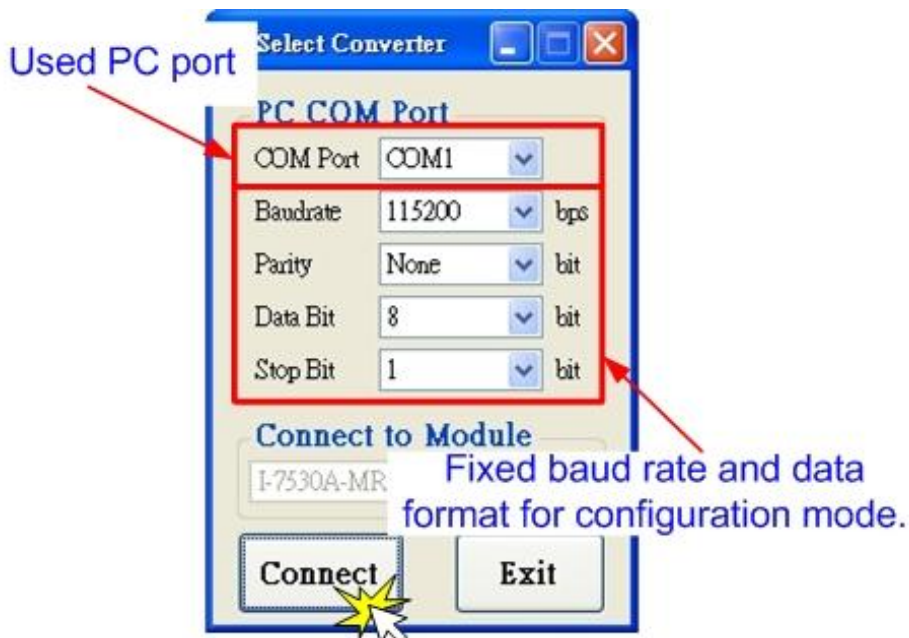

Figure 3-7: The PC's COM port configuration form.

**Note:** When the I-7530A-MR is working in the configuration mode, it can only be communicated by using 115200 baud rate.

7. Then the I-7530A-MR configuration window will be brought out. The UART2CAN Utility will show the communication information of the I-7530A-MR module, as shown in the following figure.

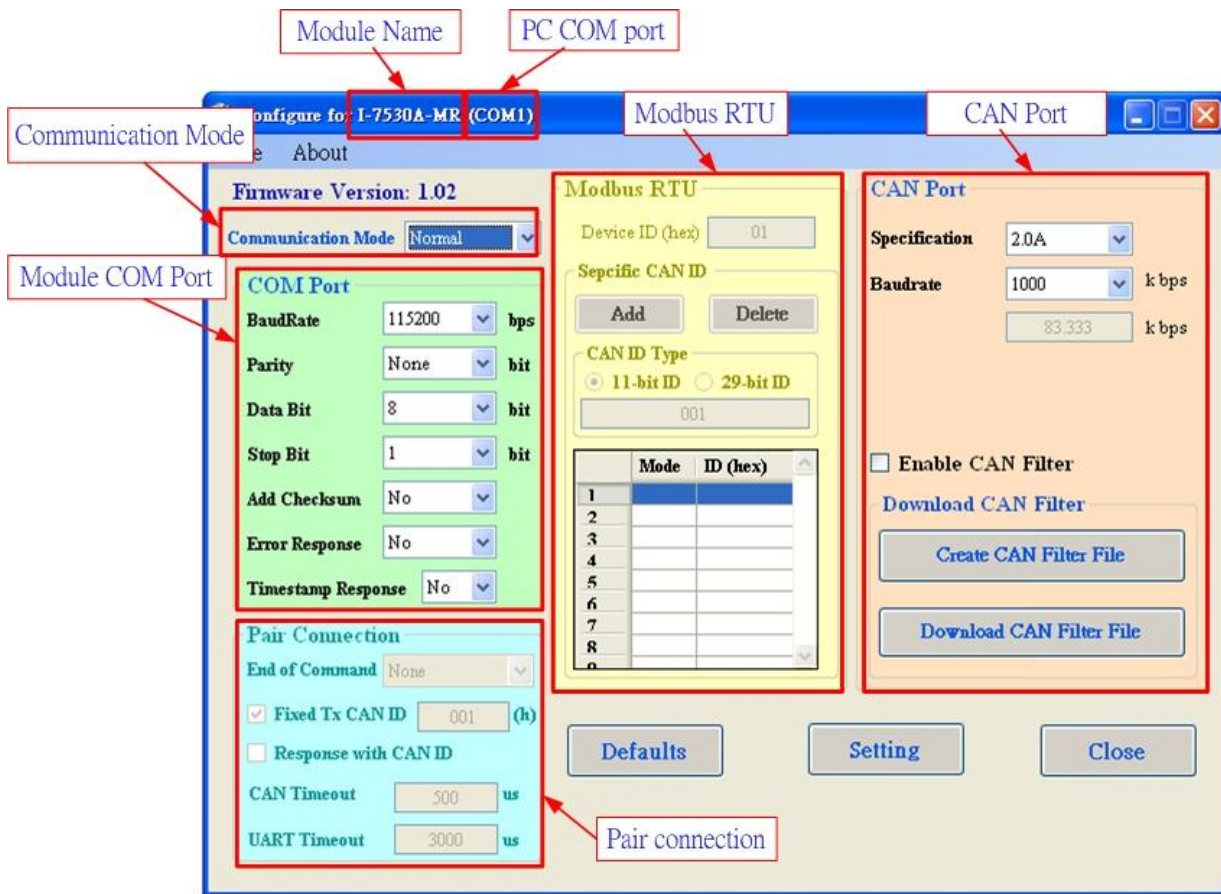

Figure 3-8: The configuration form of the I-7530A-MR module.

### 3.2.2 Select the communication mode

The I-7530A-MR supports four communication modes: “Normal”, “Pair connection”, “Modbus Slave”, and “Modbus Master Mode”.

In the Normal mode, it accurately converts ASCII format messages and CAN messages between RS-232/485/422 and CAN interfaces. In the Modbus Slave mode, it allows a Modbus master to communicate with CAN devices on a CAN network. In pair-connection mode, this module provides the transparent communication between the RS-232/485/422 devices via CAN bus. In the Modbus Master mode, this module is worked as Modbus Master/CAN module. It can communicate with Modbus slave device via RS-232/485/422.

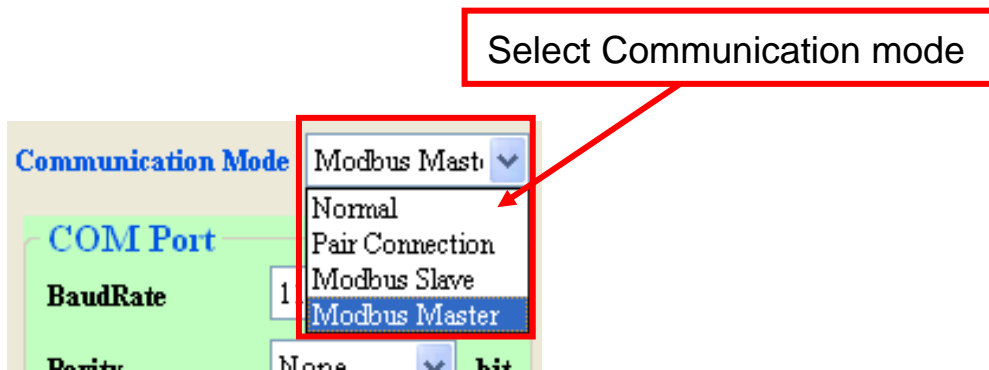

Figure 3-9: Select Communication Mode.

### 3.2.3 Set the COM port parameters

1. When the function “Add Checksum” is set to “Yes”, users need to communicate to the I-7530A-MR with checksum mechanism. (For checksum algorithm, please refer to page 51)
2. If the “Error Response” is set to “Yes”, the error code will be responded when the incorrect communication commands are sent to the I-7530A-MR.
3. If the “Timestamp Response” is set to “Yes”, the timestamp value will be responded when the CAN message commands are sent out from the COM port of I-7530A-MR.

These three parameters above can only use at the “Normal” communication mode.



Figure 3-10: The COM port of I-7530A-MR configuration.

### 3.2.4 Set the CAN parameters

Select the communication parameters of the CAN port and check the “Enable CAN Filter” item to make the CAN filter enable if necessary. About how to set the CAN Filter, please refer to the section 3.3.

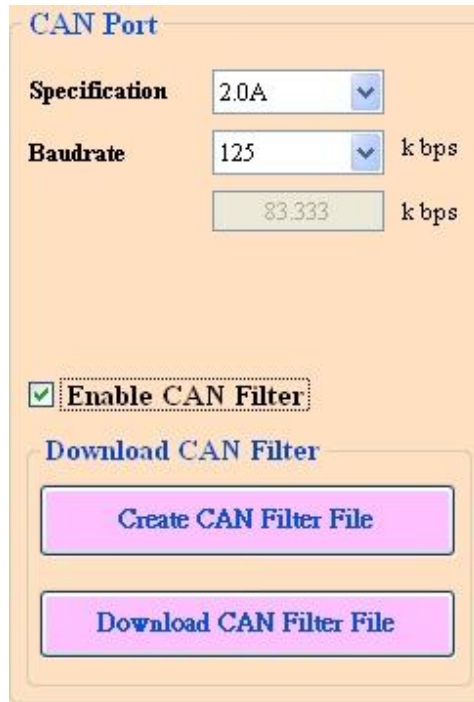

Figure 3-11: The CAN port of I-7530A-MR configuration.

### 3.2.5 Set the “Pair Connection” parameter

When users select the “Pair Connection” communication mode, the functions, “End of Command”, “Fixed Tx CAN ID” and “Response with CAN ID”, are useful. In pair connection mode, all commands written to I-7530A-MR COM port will be transferred to the CAN bus directly. For more detail information about pair connection mode, please refer to the section 3.4.

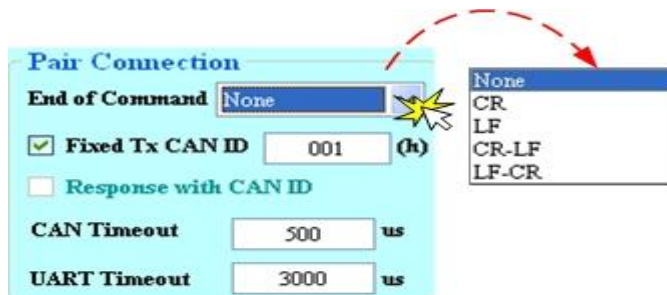

Figure 3-12: The configuration for Pair connection.

### 3.2.6 Set the “Modbus Slave” parameter

When users select the “Modbus Slave” communication mode, the functions, “Device ID” and “Specific CAN ID”, are useful. In the “Specific CAN ID” field, users can set maximum 10 CAN IDs (firmware v1.02 or later supports 100 CAN ID of CAN messages) which indicate the corresponding CAN messages to be stored in the specific Modbus Input Register respectively. In the Modbus Input Register, the register range of the “Specific CAN ID” occupies the section from 0x0800 to 0x0859. Each CAN ID will use 9 Modbus input registers.

In Modbus Slave mode, users need to communicate with the I-7530A-MR via using Modbus RTU command. The I-7530A-MR only supports function code 03/04/06/10 of Modbus RTU commands for reading and writing CAN messages. For more details about Modbus Slave mode, please refer to the section 5.

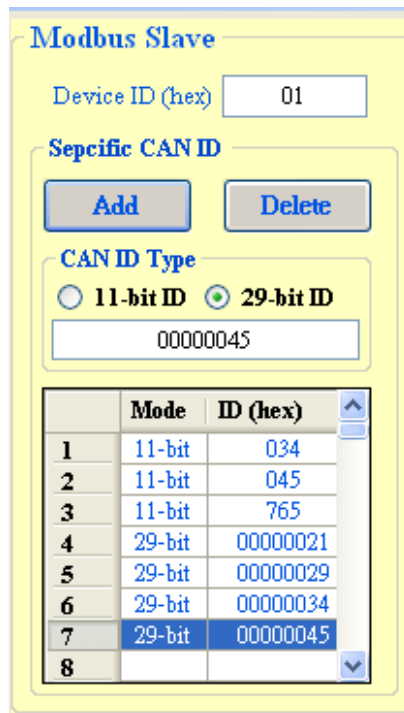

Figure 3-13: The configuration for Modbus Slave mode.

---

### 3.2.7 Configuration of default value

If users click the “Defaults” button, all of the module communication parameters on the I-7530A-MR will be set to the factory default, which are:

Communication Mode = Normal

RS232/485/422: Baud rate = 115200 kbps  
Data Bit = 8  
Stop Bit = 1  
Parity = None  
Add Checksum = No  
Error Response = No  
Timestamp Response = No

CAN bus: CAN Specification = 2.0A  
CAN bus Baud rate = 125 kbps  
Enable CAN Filter = unchecked

Pair-connection: End of Command = None  
Fixed Tx CAN ID = checked  
Response with CAN ID = unchecked

Modbus Slave: Device ID = 1  
Specify CAN ID Table = empty

### 3.2.8 Load/Save the parameter configuration

The “Open Parameter File” function provides users to load parameters from existing configuration file (\*.INI). And the “Save Parameter from Utility” function provides users to save the current configuration to a file (\*.INI).

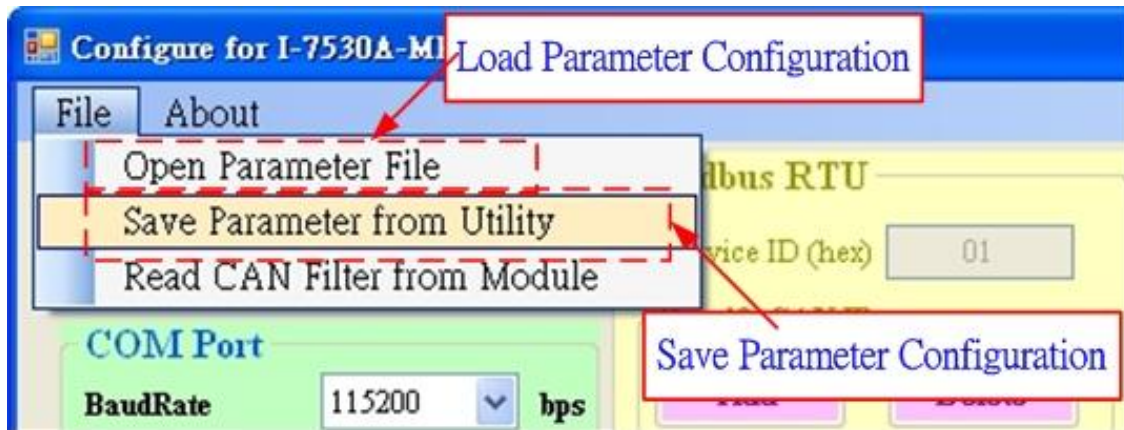

Figure 3-14: Load/Save the parameter configuration from/to file.



### 3.3 CAN Filter Configuration

There are two parts of the CAN filter configuration. One is “Download CAN Filter” which are used to configure the CAN filter and download the result into the I-7530A-MR module. The other is “Read CAN Filter” which are used to read back the CAN filter configuration from the I-7530A-MR. In this section, we will describe how to configure the CAN Filter with the Utility tool.

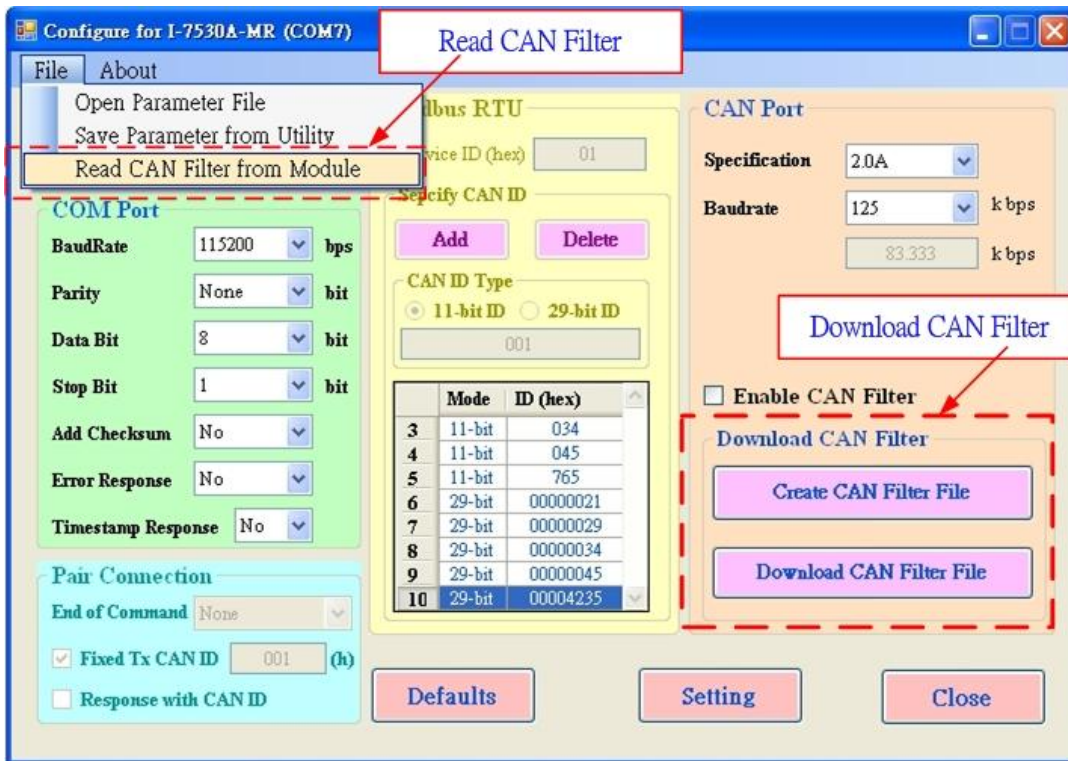

Figure 3-15: The configuration for CAN Filter.

#### 3.3.1 Create New CAN Filter

When users set the CAN filter first time, they need use “Download CAN Filter” field.

**Step 1:** Click the “Create CAN Filter File” button to start setting CAN filter. Then users will see the following window.



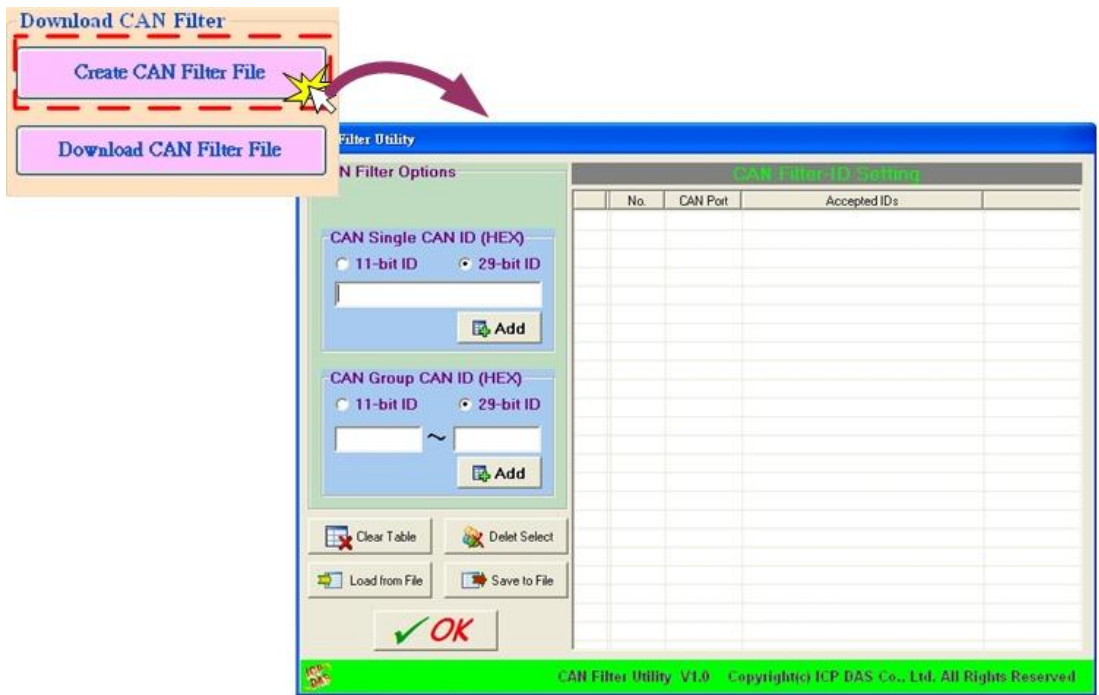

Figure 3-16 Create CAN filter file

**Step 2:** Add the CAN filter with single CAN ID or group CAN ID. Then, the CAN ID in the list will be received and other CAN IDs which are not in list will be dropped.

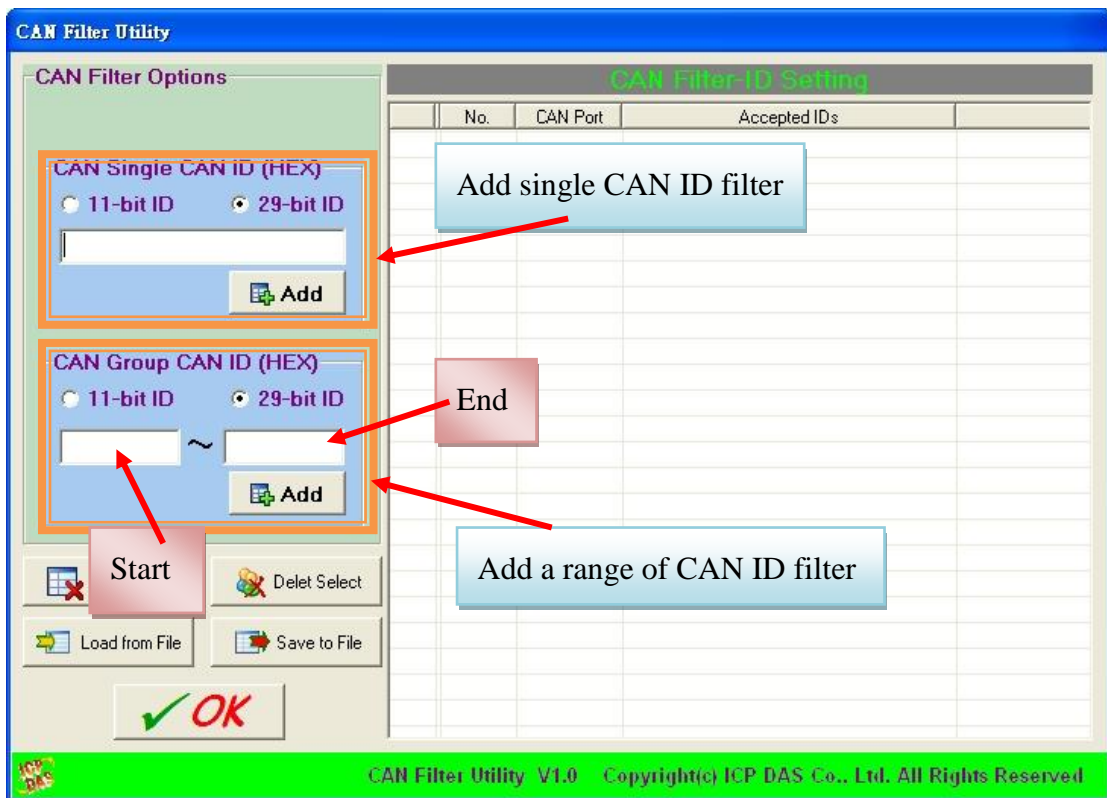

Figure 3-17 Add single or group CAN filter

For example, if users want to pass the CAN port with CAN ID 0x07F in the CAN 2.0B specification.

Step1: Select “29-bit ID” item in the “CAN Single CAN ID” field.

Step2: Fill the value “7F” in the edit box.

Step3: Click “Add” button in the “CAN Single CAN ID” field.

Another example, if users want to pass the CAN port with CAN ID from 0x04 to 0x15 in the CAN 2.0A specification.

Step1: Select “11-bit ID” item in the “CAN Group CAN ID” field.

Step2: Fill the value “4” in the “Start” field and the value “15” in the “End” field.

Step3: Click “Add” button in the “CAN Group CAN ID” field.

After completing these two examples, users will see the follow figure.

CAN Filter-ID Setting			
No.	CAN Port	Accepted IDs	
0	2	4 ~ 15	
1	2	7F	

Figure 3-18 Two CAN filter data

The “No.” field means that the sequential number of the CAN filter setting. The “CAN Port” field means that the filter setting is belong to which CAN port. In the I-7530A-MR module, users don’t need to care about this field.

The “Accepted IDs” field means that which CAN ID can be passed.

There are four small icon pictures which represent some information.



This icon means that this CAN filter is 11-bit and single CAN ID.



This icon means that this CAN filter is 11-bit and group CAN ID.



This icon means that this CAN filter is 29-bit and single CAN ID.



This icon means that this CAN filter is 29-bit and group CAN ID.

Step 4: When completing the CAN filter configuration, click the “Save to File” button to save it for backup. It will save the filter data with “\*.FLT”

extension file name.

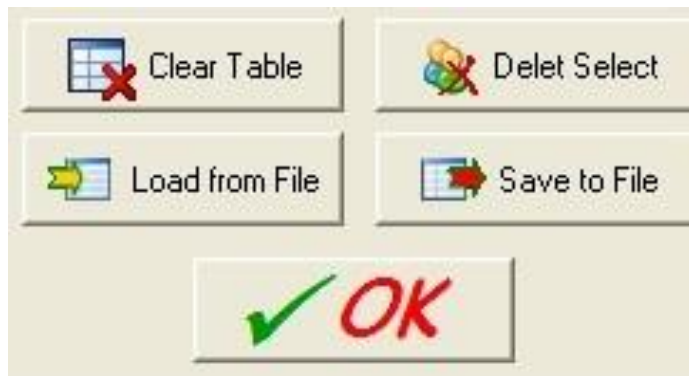

Figure 3-19 Five buttons in CAN filter configuration dialog

There are five buttons to help users to configure the CAN filter.

1. The “Clear Table” would delete all CAN filter setting in the list.
2. The “Delete Select” would delete the CAN filter setting which users selected.
3. The “Load from File” provides users to load filter data from the existence log file (\*.FLT).
4. The “Save to File” provide users save current CAN filter setting as file (\*.FLT).
5. The “OK” would exit the configuration dialog.

### 3.3.2 Download a existed CAN Filter file

Click “Download CAN Filter File” to download the selected CAN filter file into the I-7530A-MR module.



Figure 3-20 Download CAN filter data

### 3.3.3 Read I-7530A-MR CAN Filter Configuration

Click the “Read from Module” item on the Utility tool bar to read CAN filter setting from the I-7530A-MR module and save the CAN filter setting as a file (\*.FLT).

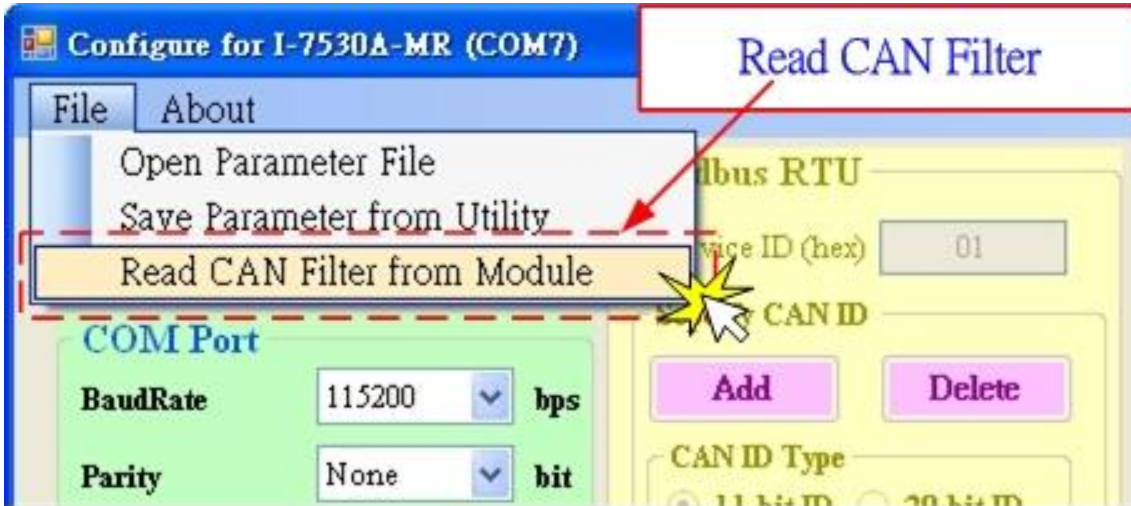

Figure 3-21 Read CAN filter form the I-7530A-MR module

### 3.4 Pair-connection Mode Description

The pair connection function usually needs two I-7530A-MRs. When these two I-7530A-MRs are in pair connection mode, all RS-232/485/422 commands transmitted from one of these two I-7530A-MRs will be put in the data field of CAN message. This CAN message will be transferred to RS-232/485/422 commands by another I-7530A-MR. The following section will show each condition for different pair connection configuration.

#### Application 1:

This application may be used in two general RS-232 devices which need to connect with each other, but the distance between is too long to communicate by using RS-232.

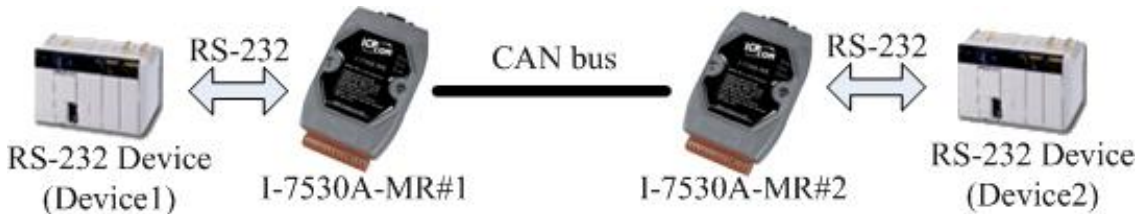

Figure 3-22: The diagram of Application 1.

#### Configurations:

To apply this application, users need to configure the I-7530A-MR#1 and I-7530A-MR#2 as follows. The RS-232 configurations of the I-7530A-MR#1 and I-7530A-MR#2 are decided by the Device1 and Device2 RS-232 parameters.

**Pair Connection**

End of Command  ▼

Fixed Tx CAN ID  (h)

Response with CAN ID

CAN Timeout  us

UART Timeout  us

I-7530A-MR#1 Configuration

**Pair Connection**

End of Command  ▼

Fixed Tx CAN ID  (h)

Response with CAN ID

CAN Timeout  us

UART Timeout  us

I-7530A-MR#2 configuration

#### Communication Descriptions:

If there are 7 bytes data, “1234567”, transmitted from Device1, the Device2 will also receive “1234567” from the COM port of I-7530A-MR#2.



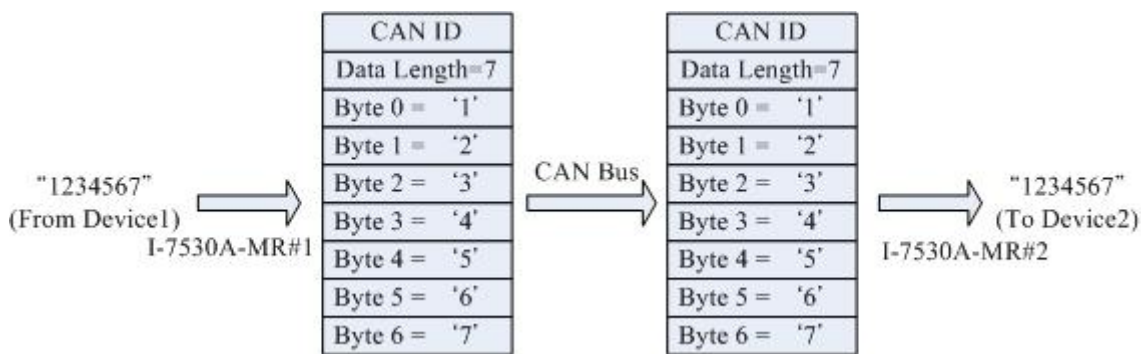

The CAN ID in above figure is determined by the CAN specification selected by users. If users select CAN 2.0A, the CAN ID is 11-bit ID. If CAN 2.0B is used, the CAN ID is 29-bit ID. Here, assume users set the Fixed Tx CAN ID field of I-7530A-MR#1 to be 0x001 ( "0x" is for hexadecimal format) and CAN 2.0A is used, the CAN ID displayed in above figure is 0x001.

If there are 9 bytes data, "123456789", transmitted from Device1, the Device2 will also receive "123456789" from the COM port of the I-7530A-MR#2.

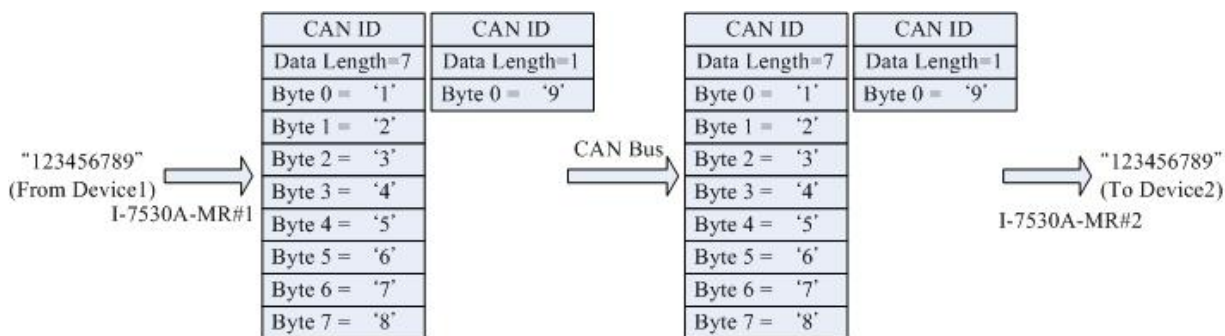

**Note1:** If users use 115200bps for RS-232 port of I-7530A-MR, it is recommended that the configuration of the I-7530A-MR CAN baud rate is closed to the configuration of RS-232 baud rate, such as 125K bps. When you use pair connection function of the I-7530A-MR, the baud rate under 125K bps is proper. (Max. 256 bytes data at the same time)

**Note2:** "CAN Timeout" and "UART Timeout" parameters are the timeout values for I-7530A-MR to check when to send message to the other side. When receiving a message, the timeout will be refreshed. And when the timeout reach to zero, message will be sent. The units of these two values are micro-second.

## Application 2:

This application architecture is the same as the one of application 1. The application architecture is shown below. The difference will be discussed in the following paragraph.

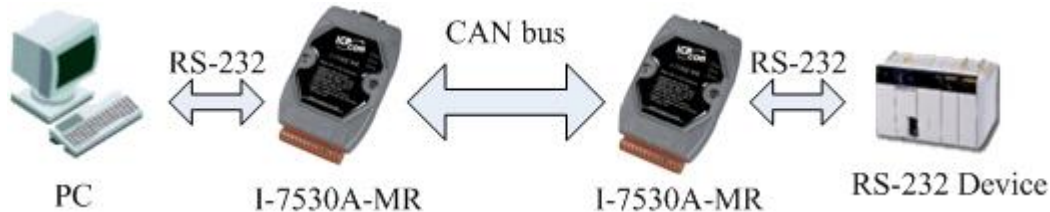
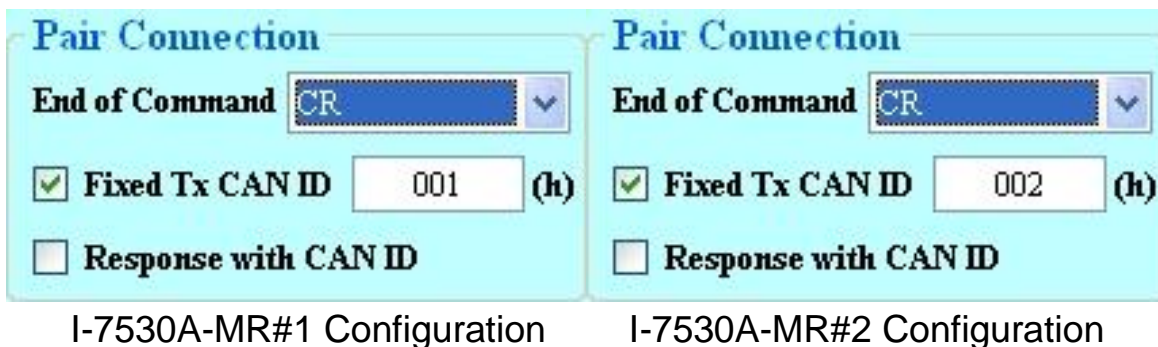

Figure 3-23: The diagram of Application 2.

## Configurations:

To apply this application, user need to configure the I-7530A-MR#1 and I-7530A-MR#2 as follows. The RS-232 configurations of the I-7530A-MR#1 and I-7530A-MR#2 are decided by the Device1 and Device2 RS-232 parameters.



## Communication Descriptions:

The communication of this condition is similar with the communication of condition 1. The difference is that the I-7530A-MR#2 of the application 1 will transfer the RS-232 commands to Device2 immediately if it receives any CAN message from the I-7530A-MR#1. The I-7530A-MR#2 of application 2 will not transfer the RS-232 commands to Device2 until it has checked the end character of RS-232 command (The end of RS-232 command is 'CR'). For example, if the Device1 sends RS-232 commands "123456789", the Device2 in application 1 will receive the data "12345678" immediately, and receive the data "9" with a little delay. But, Device2 in application 2 will receive the data "123456789" at the same time (Max. 256 bytes data at the same time).

Application 3:

This application may be used to construct a RS-232 device network via CAN bus. The architecture is shown below.



Figure 3-24: The diagram of Application 3.

Configurations:

In order to apply this application, users need to configure the I-7530A-MR#1, I-7530A-MR#2, and I-7530A-MR#3 as follows. The RS-232 configurations of these I-7530A-MRs are decided by the connected RS-232 device.

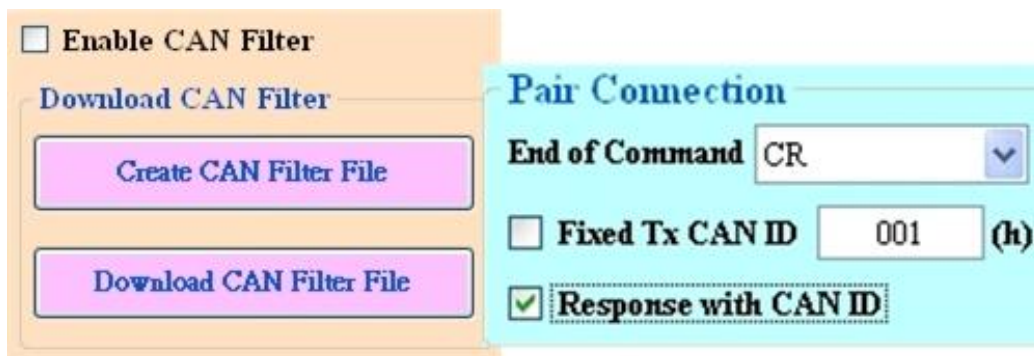

Figure 3-25: I-7530A-MR#1 Configuration.



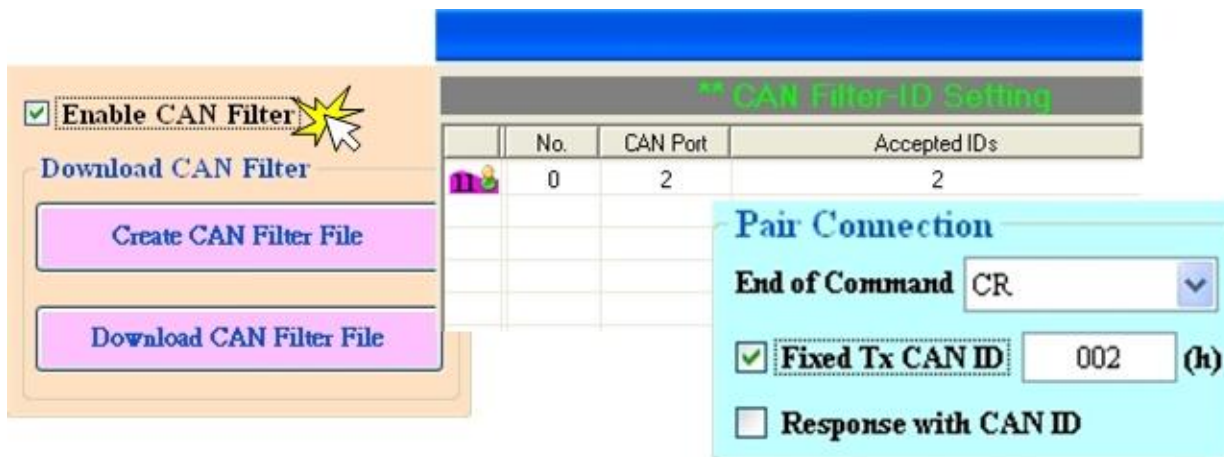

Figure 3-26: I-7530A-MR#2 Configuration.

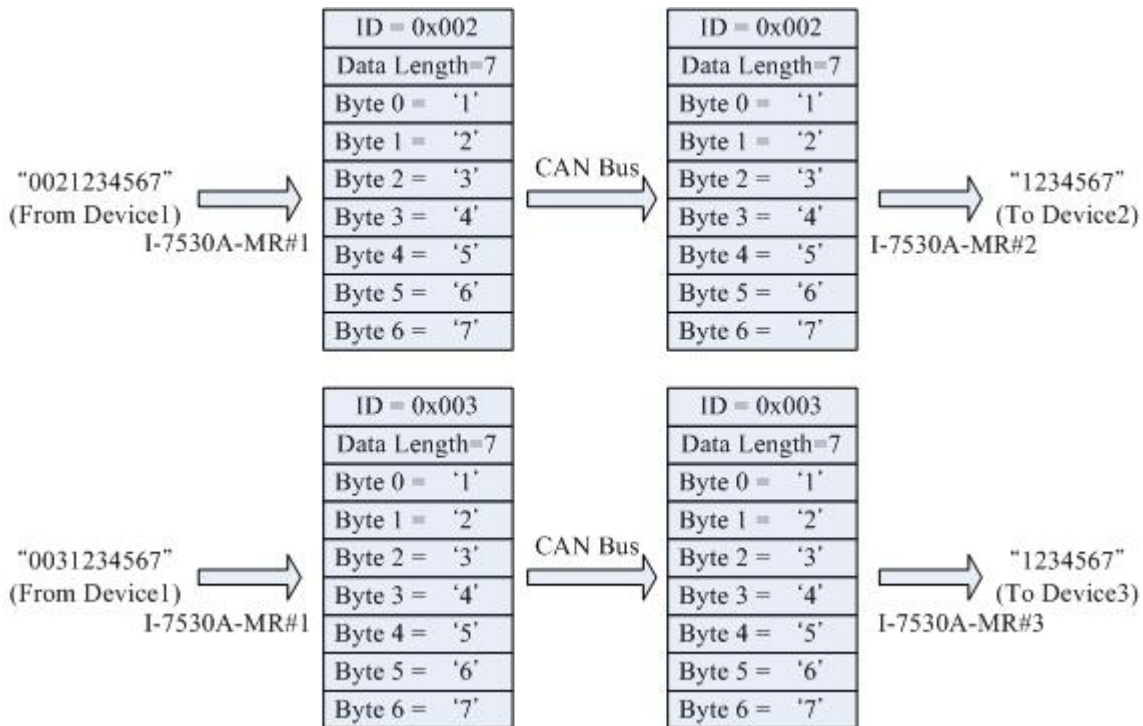

Figure 3-27: I-7530A-MR#3 Configuration.

### Communication Descriptions:

When the Device1 want to transmit the RS-232 command “1234567” to Device2, the command written to I-7530A-MR#1 by the Device1 needs to be “0021234567” because the Device1 is set to dynamic Tx CAN ID (Fixed Tx CAN ID is not checked). The first three bytes of “0021234567” is “002”, it means that the CAN ID is 0x002 while the I-7530A-MR#1 receives the RS-232 commands from the Device1 and transfers it to CAN message. Afterwards, this CAN message is only accepted by Device2 because the configurations of acceptance code and acceptance mask of Device2. Similarly, if Device1 wants to send the RS-232 command “1234567” to Device3, it needs to send “0031234567” to the COM port of the I-7530A-MR#1. When the Device2 or Device3 respond the RS-232 commands “456789”, the CAN message will have CAN ID “0x002” and “0x003” because of the configurations of the “Fixed Tx CAN ID” of the I-7530A-MR#2 and I-7530A-MR#3. Due to the response CAN ID of the I-

7530A-MR#1 I-7530A-MR#2, the Device1 will receive the RS-232 commands “002456789” or “003456789”. Therefore, Device1 can decide the target device which RS-232 commands will be sent to. Also, Device1 knows where the RS-232 commands come from. The general concept of transmitting data from Device1 to Device2 is shown below.



**Note:** In pair connection mode, all command strings listed in the section 4 are useless.

---

### 3.5 Testing the I-7530A-MR module

The following procedure will guide users to learn how to transmit/receive CAN messages to/from other devices/PCs by using the I-7530A-MR converter.

1. Set the Init/Normal switch to the Normal position, which is found on the back of the I-7530A-MR module.
2. Connect the I-7530A-MR's CAN port into the CAN network, which must at least have one CAN device on the network.
3. Supply the 10~30 V<sub>DC</sub> power into the I-7530A-MR module through the power terminal.
4. The PWR LED on the I-7530A-MR module will be turned on and the other LEDs will be turned off. That means the I-7530A-MR is working in the operation mode.
5. Run the UART2CAN Utility software after connecting the PC and the I-7530A-MR via cable CA-0910. Please refer to the figure 2-14.
6. Select the PC COM port, baud rate and data format, which will be used to connect with the COM port of the I-7530A-MR.

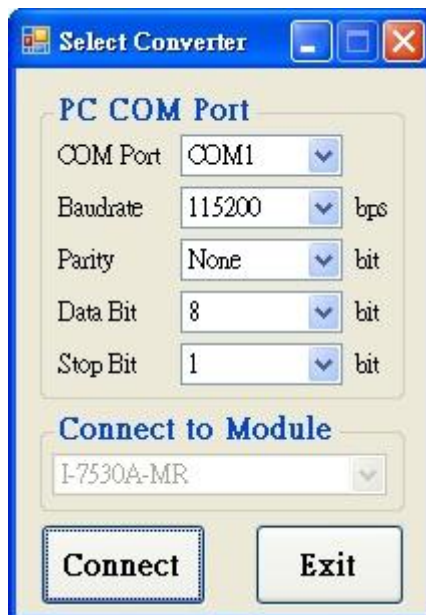

Figure 3-28: The configuration for the PC COM port.

7. Press the “Connect” button. Then the UART2CAN Utility will show the diagnostic window, as the figure below.

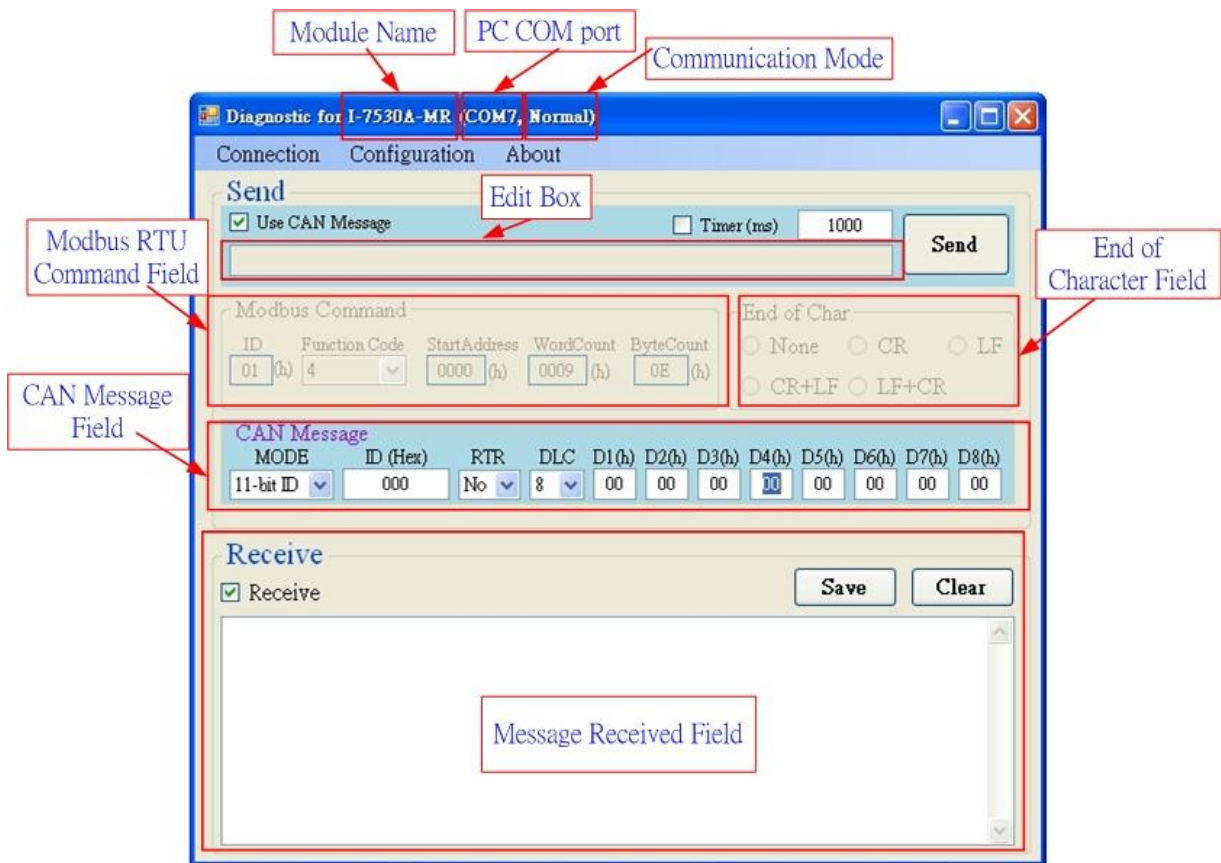

Figure 3-29: Description of diagnostic form

8. Then users can transmit or receive CAN messages via the I-7530A-MR module.

In this Utility tool, it supports three communication modes to transmit/receive CAN messages to/from other devices/PCs by using the I-7530A-MR. There are the Normal mode, Pair connection mode and Modbus Slave mode. In the next section, we will describe how to use it.

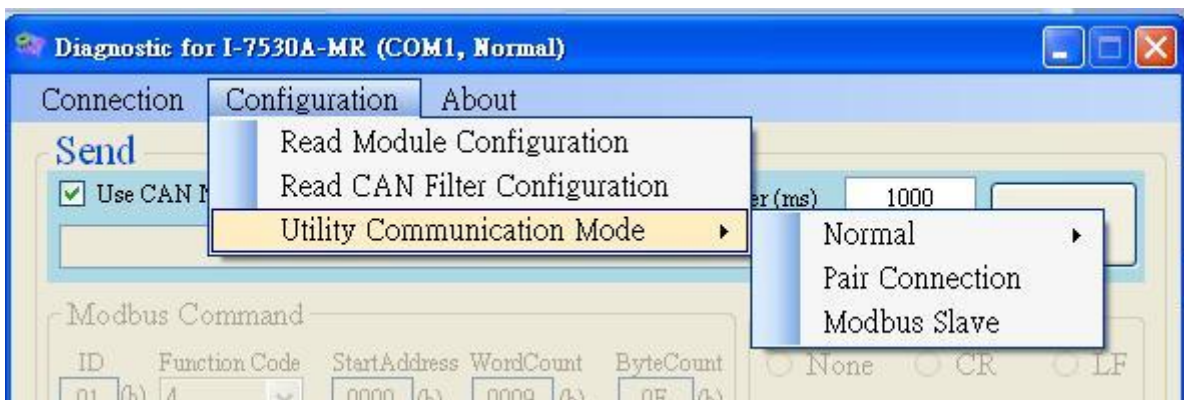

Figure 3-30: Select communication mode for the Utility.

### 3.5.1 Normal mode

In this mode, there are two methods for users to send messages to the I-7530A-MR. The Utility screenshot is shown below.

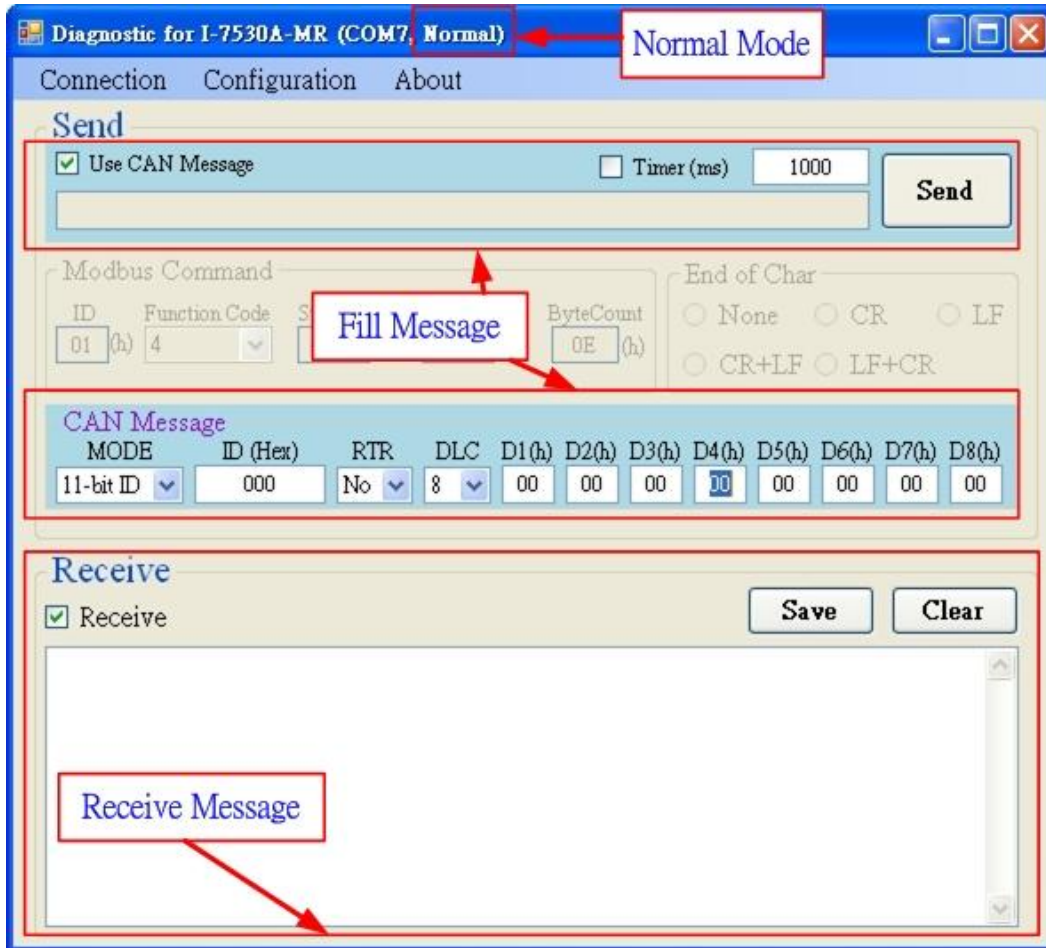

Figure 3-31: The active area of the Utility in Normal mode.

The first method (check “Use CAN Message”) requires users to understand what message they want to send. Users need to key-in each part data of a CAN message. The second method (uncheck “Use CAN Message”) allows the use of the command string found in table 4-1 to transmit messages. Both methods require the user to click the “Send” button to transmit the information to the CAN network. When checking the “Timer (ms)”, the Utility will transmit the message periodically. If the function “Add Checksum” is set to “Yes”, it means that messages sent to the I-7530A-MR by the Utility will be run with checksum mechanism.



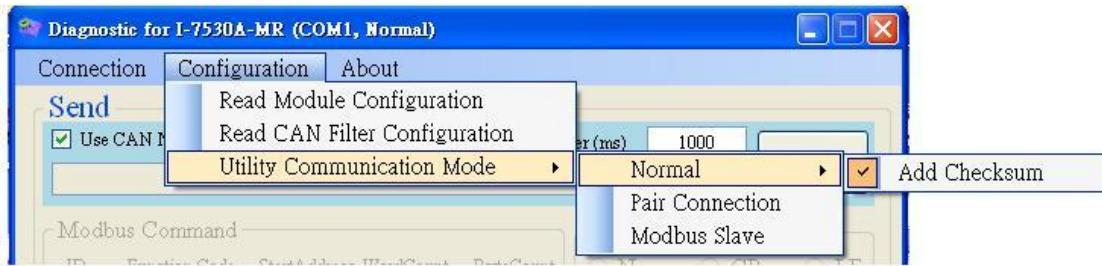

Figure 3-32: Enable the checksum mechanism in the Utility.

If the “Receive” is checked, the messages sent from the I-7530A-MR will automatically be received and displayed in the “Receive” text box. Besides, users can click the “Clear” button to remove the messages in the text box. In addition, users can click the “Save” button to save the CAN messages in the “Receive” text box into the “I-7530A-MR\_N\_yyyyMMddmmss.txt” file. The indication of the file name is described as the figure below.

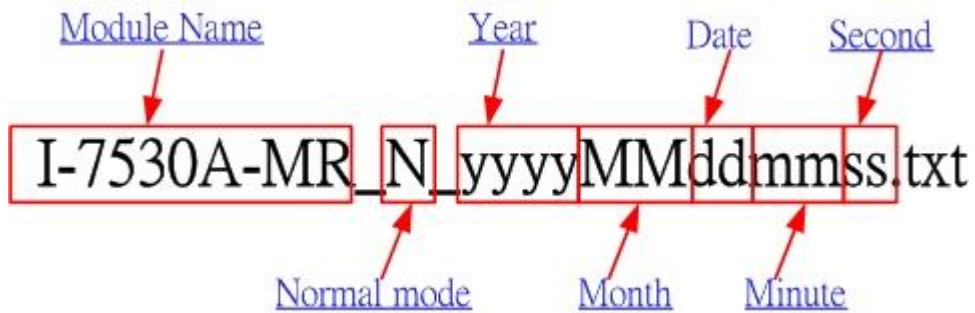

Figure 3-33: The indication of the message log file name.

### 3.5.2 Pair Connection Mode

The testing Utility screenshot is shown below.

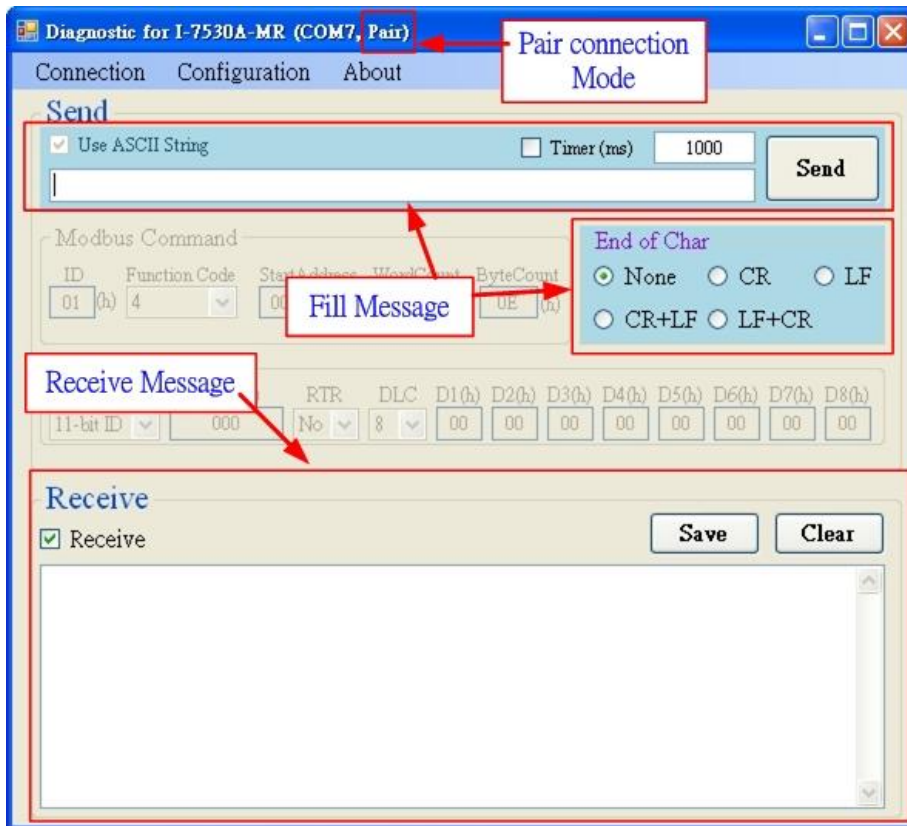

Figure 3-34: The active area of the Utility in the Pair connection mode.

User can key-in any information to the edit box and select the end of character. Then click the “Send” button to transmit the information to the CAN network. When checking the “Timer (ms)”, the Utility will transmit the message periodically.

If the “Receive” is checked, the message sent from the I-7530A-MR will automatically be received and displayed in the “Receive” text box. Besides, users can click the “Clear” button to remove the messages on the text box. In addition, users can click the “Save” button to save the messages in the “Receive” text box into the “I-7530A-MR\_P\_yyyyMMddmmss.txt ” file. The indication of the file name is described below.



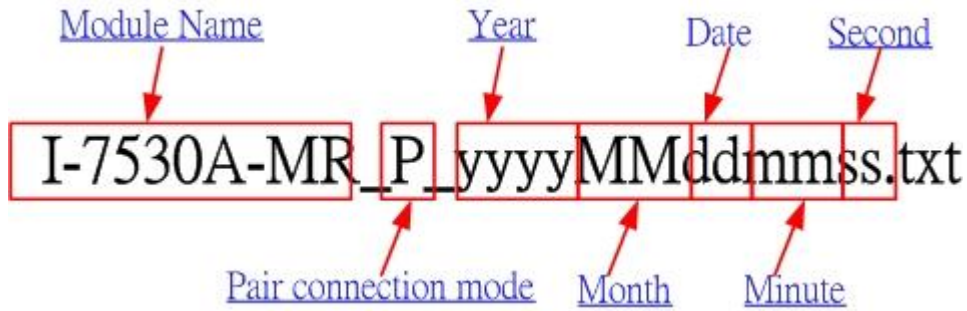

Figure 3-35: The indication of the name in the Pair connection mode.

### 3.5.3 Modbus Slave Mode

In this mode, there are two methods for users to send command to the I-7530A-MR. The screenshot of the Utility is shown below.

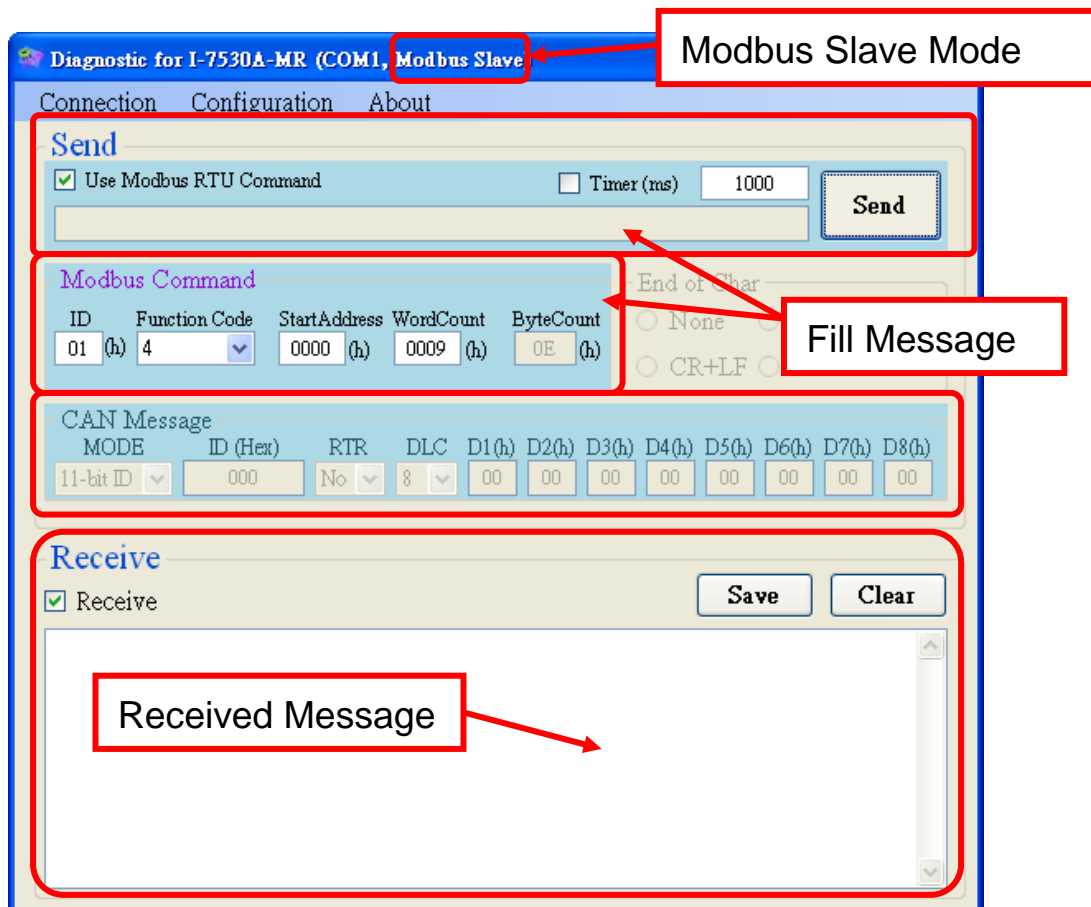

Figure 3-36: The active area of the Utility in the Modbus Slave mode.

Through the first method (check “Use Modbus RTU Command”) users can use the function code 0x03, 0x04, 0x06(firmware version v1.11 or later), 0x10 of Modbus RTU commands for reading and writing CAN message. The second method (uncheck “Use Modbus RTU Command”) requires users to understand the Modbus RTU protocol. Then key-in the correct Modbus RTU command in the text box. Both of the methods

---

require users to click the “Send” button to transmit the command to the I-7530A-MR module. When checking the “Timer (ms)”, the Utility will transmit the command periodically.

If the “Receive” is checked, the messages sent from the I-7530A-MR will automatically be received and displayed in the “Receive” text box. Besides, users can click the “Clear” button to remove the messages on the text box. In addition, users can click the “Save” button to save the messages in the “Receive” text box into the “I-7530A-MR\_M\_yyyyMMddmmss.txt ” file. The indication of the file name is described below.

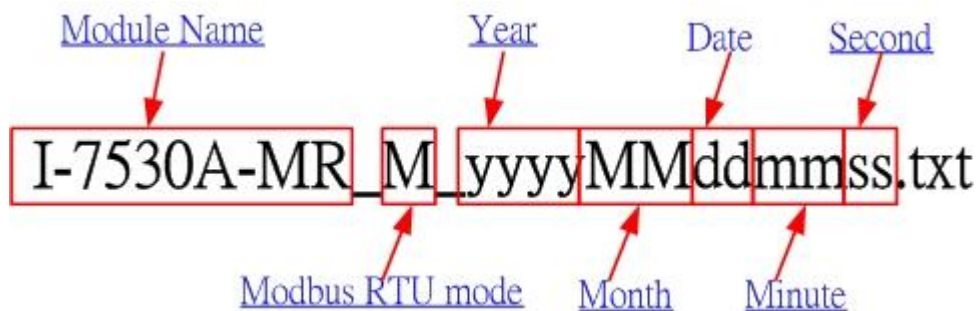

Figure 3-37: The indication of the file name in the Modbus Slave mode.

## 4. Command list (Only for normal mode)

In order to simplify the application, we provide 9 command strings to send/receive commands through the I-7530A-MR. It can cover most of the applications. The general formats of the commands for the I-7530A-MR are given below:

Command Format: <Command>[CHK]<CR>

- <Command> : RS-232/485/422 commands of the I-7530A-MR
- [CHK] : 2-character checksum value. It is effective only if the checksum mechanism is set to enable by using UART2CAN Utility. [For checksum algorithm, please refer to page 51](#)
- <CR> : All RS-232/485/422 commands of the I-7530A-MR must be ended with the character “<CR>” (The ASCII value is 13).

The 9 command formats are given in the following table. More detailed information related to the each command will be described in the following sub sections.

Table 4-1: Command list table

Command	Description
tIIILDD...[CHK]<CR>	Send or receive a standard data frame.
TIIIL[CHK]<CR>	Send or receive a standard remote frame.
eIIIIIIILDD...[CHK]<CR>	Send or receive an extended data frame.
EIIIIIIIL[CHK]<CR>	Send or receive an extended remote frame.
S[CHK]<CR>	Read the status value of the I-7530A-MR
P0BBDSPCE[CHK]<CR>	*Change the RS-232/485/422 configuration
P1B [CHK]<CR>	*Change the CAN Baud rate configuration
P2BBBBB[CHK]<CR>	*Change the user-defined CAN baud rate configuration
RA[CHK]<CR>	Reboot the I-7530A-MR module.

**\* NOTE:**

This command will write parameters into EEPROM and EEPROM is limited to 10,000,000 erase/write cycles.

---

## Checksum algorithm:

The checksum [CHK] is 2-characters of the sum of the command message, from the first character to the character before <CR>.

For example:

Command: Reboot the I-7530A-MR module, "RA[CHK]<CR>".

1. Sum of the string = 'R' + 'A' = 52h + 41h = 93h.
2. Therefore the checksum is 93h and so [CHK]="93".
3. The command string with checksum ="RA93<CR>".

---

## 4.1 tIIILDD...[CHK]<CR>

**Description:** Send or receive a standard CAN data frame.

➤ **Syntax:** tIIILDD...[CHK]<CR>

<b>t</b>	Represent a standard (2.0A) data frame.
<b>III</b>	11 bits Identifier (000~7FF)
<b>L</b>	Data length (0~8)
<b>DD...</b>	Input data frame value according to the data length (00~FF)

➤ **Response:** Valid command: No response

Invalid command: ?<Error Code><CR>

➤ **Note:** It is necessary to enable the “Error Response” function while using the UART2CAN Utility in order to receive Syntax and/or communication error information.

➤ **Example:**

Command: t03F6112233445566<CR>

Send a CAN message with a standard data frame. ID=03F, DLC=6, data1=11, data2=22, data3=33, data4=44, data5=55 and data6=66.

## 4.2 TIIIL[CHK]<CR>

**Description:** Send or receive a standard CAN remote frame.

➤ **Syntax:** TIIIL[CHK]<CR>

<b>T</b>	Represents a standard (2.0A) remote frame.
<b>III</b>	11 bits Identifier (000~7FF)
<b>L</b>	Data length (0~8)

➤ **Response:** Valid command: No response

Invalid command: ?<Error Code><CR>

➤ **Note:** It is necessary to enable the “Error Response” function while using the UART2CAN Utility in order to receive Syntax and/or communication error information.

➤ **Example:**

Command: T2E88<CR>

---

Send a CAN message with a standard remote frame. ID=2E8, DLC=8.

### 4.3 eIIIIIIILDD...[CHK]<CR>

**Description:** Send or receive an extended CAN data frame.

➤ **Syntax:** eIIIIIIILDD...[CHK]<CR>

<b>e</b>	Stands for the extended (2.0B) data frame.
<b>IIIIIII</b>	29 bits Identifier (00000000~1FFFFFFF)
<b>L</b>	Data length (0~8)
<b>DD...</b>	Input data frame value according to the data length (00~FF)

➤ **Response:** Valid command: No response

Invalid command: ?<Error Code><CR>

➤ **Note:** It is necessary to enable the “Error Response” function while using the UART2CAN Utility in order to receive Syntax and/or communication error information.

➤ **Example:**

Command: e1234567851122334455<CR>

Send a CAN message with an extended data frame. ID=12345678, DLC=5, data1=11, data2=22, data3=33, data4=44 and data5=55.

### 4.4 EIIIIIIIL[CHK]<CR>

**Description:** Send or receive an extended CAN remote frame.

➤ **Syntax:** EIIIIIIIL[CHK]<CR>

<b>E</b>	Stands for the extended (2.0B) CAN remote frame.
<b>IIIIIII</b>	29 bits Identifier (00000000~1FFFFFFF)
<b>L</b>	Data length (0~8)

➤ **Response:** Valid command: No response

Invalid command: ?<Error Code><CR>

➤ **Note:** It is necessary to enable the “Error Response” function while using



---

the UART2CAN Utility in order to receive Syntax and/or communication error information.

➤ **Example:**

Command: E010156786<CR>

Send a CAN message with an extended remote frame.  
ID=01015678, DLC=6.

## 4.5 S[CHK]<CR>

**Description:** Read the I-7530A-MR CAN baud rate and error flag message.

➤ **Syntax:** S[CHK]<CR>

**S** Command character.

➤ **Response:** Valid Command: !CFFTTRRO[CHK]<CR>  
Invalid command: ?<Error Code>[CHK]<CR>

**!** Delimiter for valid command

**C** current baud rate setting of CAN

**FF** CAN status register

**TT** CAN transmit error counter

**RR** CAN receive error counter

**O** CAN or RS-232/485/422 FIFO Overflow flag

➤ **Note:** It is necessary to enable the “Error Response” function while using the UART2CAN Utility in order to receive Syntax and/or communication error information. Furthermore, all response results are shown in the ASCII format. Users need to make an ASCII to hex format transformation in order to understand what the meaning is. The following table shows all the indications of the response of this command.

Table 4-2: CAN baud rate list

AsciiToHex(C)	Description
0	10K baud rate of CAN
1	20K baud rate of CAN
2	50K baud rate of CAN
3	100K baud rate of CAN

4	125K baud rate of CAN
5	250K baud rate of CAN
6	500K baud rate of CAN
7	800K baud rate of CAN
8	1000K baud rate of CAN
F	User-defined baud rate of CAN

Table 4-3: CAN status register list

AsciiToHex(FF)	Description
Bit 7	Bus Status (0: Bus-On, 1: Bus-Off)
Bit 6	Error Status (0: OK, 1: Error)
Bit 5	Transmit Status (0: idle, 1: transmit )
Bit 4	Receive Status (0:idle, 1: Receive)
Bit 3	Transmit Complete Status (0: incomplete, 1: complete)
Bit 2	Receive Complete Status (0: incomplete, 1: complete)
Bit 1	Data Overrun Status (0: absent, 1: overrun)
Bit 0	Receive Buffer Status (0: empty, 1: full)

Table 4-4: CAN and RS-232/485/422 FIFO overflow flag list

AsciiToHex(O)	Description
Bit 3	Reserved
Bit 2	Reserved
Bit 1	RS-232/485/422 FIFO Overflow
Bit 0	CAN FIFO Overflow

➤ **Example:**

Command: S<CR>

Receive: !50000000<CR>

Obtain some current information on the I-7530A-MR module. The response will show the following results: CAN baud rate=250K, CAN status register= normal, CAN transmit error counter=0, CAN receive error counter=0 and CAN & RS232/485/422 FIFO= normal.

## 4.6 P0BBDSPCR[CHK]<CR>

**Description:** Change the RS-232/485/422 configuration on the I-7530A-MR module and then reboot the I-7530A-MR module.

➤ **Syntax: P0BBDSPCR[CHK]<CR>**

- P0** Command character
- BB** RS-232/485/422 Baud rate
- D** Data bit
  - 0 = 5 bits Data formation
  - 1 = 6 bits Data formation
  - 2 = 7 bits Data formation
  - 3 = 8 bits Data formation
- S** Stop bit (0=1 stop bit, 1=2 stop bits)
- P** Parity (0=None, 1=Odd, 2=Even)
- C** Checksum (0=No, 1=Yes)
- R** Other response

Table 4-5: RS-232/485/422 baud rate list

BB	Description
00	Reserved
01	Reserved
02	300 bps baud rate of RS-232/485/422
03	600 bps baud rate of RS-232/485/422
04	1200 bps baud rate of RS-232/485/422
05	2400 bps baud rate of RS-232/485/422
06	4800 bps baud rate of RS-232/485/422
07	9600 bps baud rate of RS-232/485/422
08	19200 bps baud rate of RS-232/485/422
09	38400 bps baud rate of RS-232/485/422
0A	57600 bps baud rate of RS-232/485/422
0B	115200 bps baud rate of RS-232/485/422
0C	230400 bps baud rate of RS-232/485/422

Table 4-6: Other response list

AsciiToHex(R)	Description
Bit 3	Reserved
Bit 2	Reserved
Bit 1	Enable timestamp response (0: No, 1: Yes)
Bit 0	Enable error response (0: No, 1: Yes)

- 
- **Response:** A valid command will write the RS-232/485/422 configuration parameters into the EEPROM and then reboot the I-7530A-MR module.  
Invalid command: ?<Error Code><CR>
  - **Note:** It is necessary to enable the “Error Response” function while using the UART2CAN Utility in order to receive Syntax and/or communication error information.
  - **Example:**  
Command: P00B30000<CR>  
Set the RS-232/485/422 baud rate=115.2 kbps, data bit=8, stop bit=1, none parity, no checksum, no error responses and no timestamp responses into the I-7530A-MR module and then reboot the I-7530A-MR module.

---

## 4.7 P1B [CHK]<CR>

**Description:** Change the CAN Baud rate configuration of the I-7530A-MR module and then reboot the I-7530A-MR module.

➤ **Syntax: P1B[CHK]<CR>**

- P1** Command character
- B** CAN Baud rate

Table 4-7: CAN baud rate list

B	Description
0	10 kbps baud rate of CAN
1	20 kbps baud rate of CAN
2	50 kbps baud rate of CAN
3	100 kbps baud rate of CAN
4	125 kbps baud rate of CAN
5	250 kbps baud rate of CAN
6	500 kbps baud rate of CAN
7	800 kbps baud rate of CAN
8	1000 kbps baud rate of CAN
9,A,B,C,D,E	Reserved
F	User-defined baud rate of CAN

- **Response:** A valid command will write the CAN configuration baud rate into the EEPROM and then reboot the I-7530A-MR module.  
Invalid command: ?<Error Code><CR>
- **Note:** It is necessary to enable the “Error Response” function while using the UART2CAN Utility in order to receive Syntax and/or communication error information.
- **Example:**  
Command: P14<CR>  
Set the CAN baud rate=125 kbps into the I-7530A-MR module and then reboot the I-7530A-MR module.

---

## 4.8 P2BBBBB[CHK]<CR>

**Description:** Change the user-defined CAN baud rate configuration of I-7530A-MR module and then reboot the I-7530A-MR module.

➤ **Syntax:** P2BBBBB[CHK]<CR>

<b>P2</b>	Command character
<b>BBBBB</b>	User-defined CAN baud rate

➤ **Response:** A valid command will write the user-defined CAN baud rate configuration into the EEPROM and then reboot the I-7530A-MR module.

Invalid command: ?<Error Code><CR>

➤ **Note:** It is necessary to enable the “Error Response” function while using the UART2CAN Utility in order to receive Syntax and/or communication error information. Furthermore, the value of BBBBB is the baud rate value multiplied 1000 and then converted into HEX format. For example, assume that users want to set the CAN baud rate as 83.333 kbps. The value BBBBB is the hex format of the value14585 (83.333 x 1000).

➤ **Example:**

Command: P214585<CR>

Set the CAN baud rate=83.333 kbps into the I-7530A-MR module and then reboot the I-7530A-MR module.



---

## 4.9 RA[CHK]<CR>

**Description:** Reboot the I-7530A-MR module. This command is usually used while the status of CAN bus is bus-off. In this case, users can use this command to reboot the module to work it again.

➤ **Syntax:** RA[CHK]<CR>

**RA**            Command character

➤ **Response:** Valid command will reboot the I-7530A-MR module.

Invalid command: ?<Error Code><CR>

➤ **Note:** It is necessary to enable the “Error Response” function while using the UART2CAN Utility in order to receive Syntax and/or communication error information.

➤ **Example:**

Command: RA<CR>

The I-7530A-MR module will reboot after it had received this command.

---

## 4.10 General Error code for all command

If the Error response function on the I-7530A-MR\_MR module is set to be “Yes”(that means enable) via the I-7530A-MR Utility when configuration, the I-7530A-MR will automatically send the error code to the RS-232/485/422 device or the host PC through the RS-232/485/422 media when the I-7530A-MR produces an error message during the operation mode. The meanings of these error codes are given below:

Table 4-8: Error code table

Error code	Description	Possible causes & solutions
1	Invalid header	The header of the RS-232/485/422 command string is not “t”, “T”, “e”, “E”, “S”, “P0”, “P1”, “P2” nor “RA”.
2	Invalid length	The numbers of data of the CAN message does not match the data length of the CAN message. For example: Error: t001512345<CR> Right: t00150102030405<CR>
3	Invalid checksum	The checksum of the RS-232/485/422 command string does not match with the checksum calculated by the I-7530A-MR. For example: Error: t0012112209<CR> Right: t00121122FD<CR>
4	Buffer overrun	The transmission buffer overrun is happened, users should retransmit the message later when this module is normal.
5	Timeout	The ASCII command strings are sent incomplete. For example: Error: T0018 Right: T0018<CR>

---

## 5. Modbus Slave Mode

The I-7530A-MR, Modbus RTU to CAN converter, supports the Modbus RTU protocol. It can act as a Modbus RTU slave on the Modbus network. There are some mechanisms for data-exchanging between the CAN register and the Modbus RTU register as the figure at the next page.

In the Modbus Input Register, according to the different purposes these register are divided into three fields, “Normal CAN Message Field”, “Specific CAN Message Field” and “Module Status Field”. When a CAN message received from the CAN network, the I-7530A-MR will check if the Specific CAN Message filed is used or not. If it is not used, this CAN message will be stored into the “Normal CAN Message” field. This filed is similar with a kind of FIFO (first-in first-out buffer). Users can only read this field with the start address of this field by applying the Modbus commands. After users read the CAN messages from this filed, the rest unread CAN messages will be moved to the buffer with the start address of this field. This field can store maximum 200 CAN messages. Therefore, if the unread CAN messages exceed 200 records, the data is lost.

If the Specific CAN Message filed is used, the CAN messages which are marked in the specific CAN message table of the Utility tool are directly moved to the Specific CAN Message field. CAN messages with different CAN IDs will be stored in different parts of the Specific CAN Message field. Users can set maximum 10 different CAN ID of CAN messages (firmware v1.02 or later support 100 CAN ID of CAN messages). Besides, a kind of CAN ID only has one record buffer. If there are two CAN messages with the same ID, the later will over-write the former. Therefore, the Specific CAN Message filed always keeps the newest information of the corresponding CAN messages with the specific CAN IDs.

If a CAN message is sent to a CAN network from a Modbus network via the I-7530A-MR, the CAN message will be temporarily stored in Output Register and not be transmitted until the CAN bus idle. The Output Register is only one message buffer. If the data overrun is happened, users will get an error code for replying. Users can also use Modbus RTU command to read the CAN message transmitted before. It is helpful for checking the last sent record.

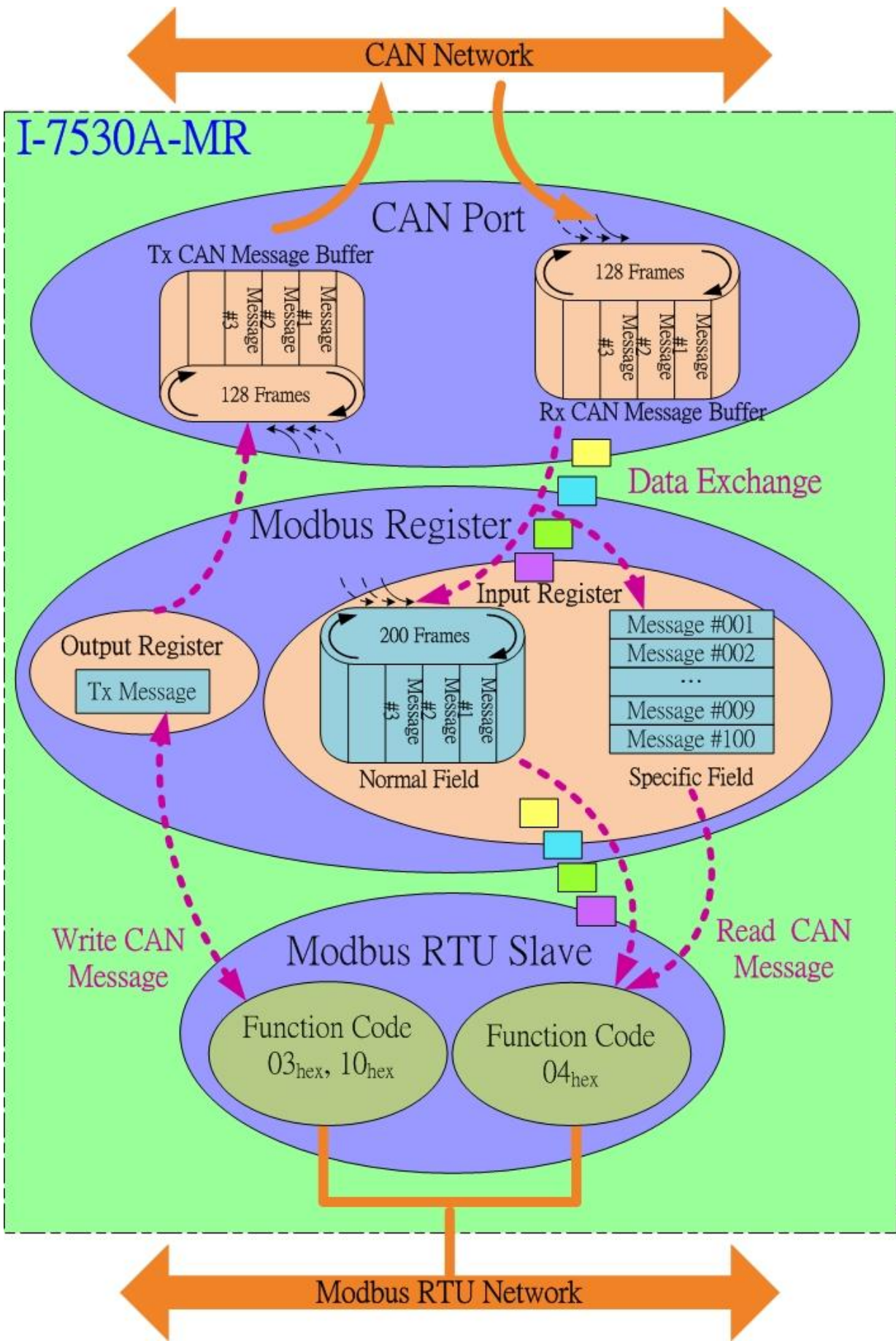

Figure 5-1: Architecture diagram for the Modbus mode.

---

## 5.1 Supported Modbus Functions

The Modbus function codes supported by the I-7530A-MR are shown in the following table.

Table 5-1: Supported Modbus Function Codes

Function Code	Function Name	Description
3 (03 Hex)	Reading Output Register	Read multiple registers for a sent CAN messages
4 (04 Hex)	Reading Input Register	Read multiple input registers for reading CAN messages
6 (06 Hex)	Write Output Register	<ol style="list-style-type: none"><li>1. Write single registers for sending a CAN message.</li><li>2. This function is implemented in firmware version v1.11 or later.</li></ol>
16 (10 Hex)	Preset Multiple Registers	<ol style="list-style-type: none"><li>1. Write multiple registers for sending a CAN message</li><li>2. Configuration Command (00256~00512)</li></ol>

## 5.2 Modbus Address

According to the different purposes these register are divided into three fields, “Normal CAN Message Field”, “Specific CAN Message Field” and “Module Status Field”. The diagram of Input Register are shown below :

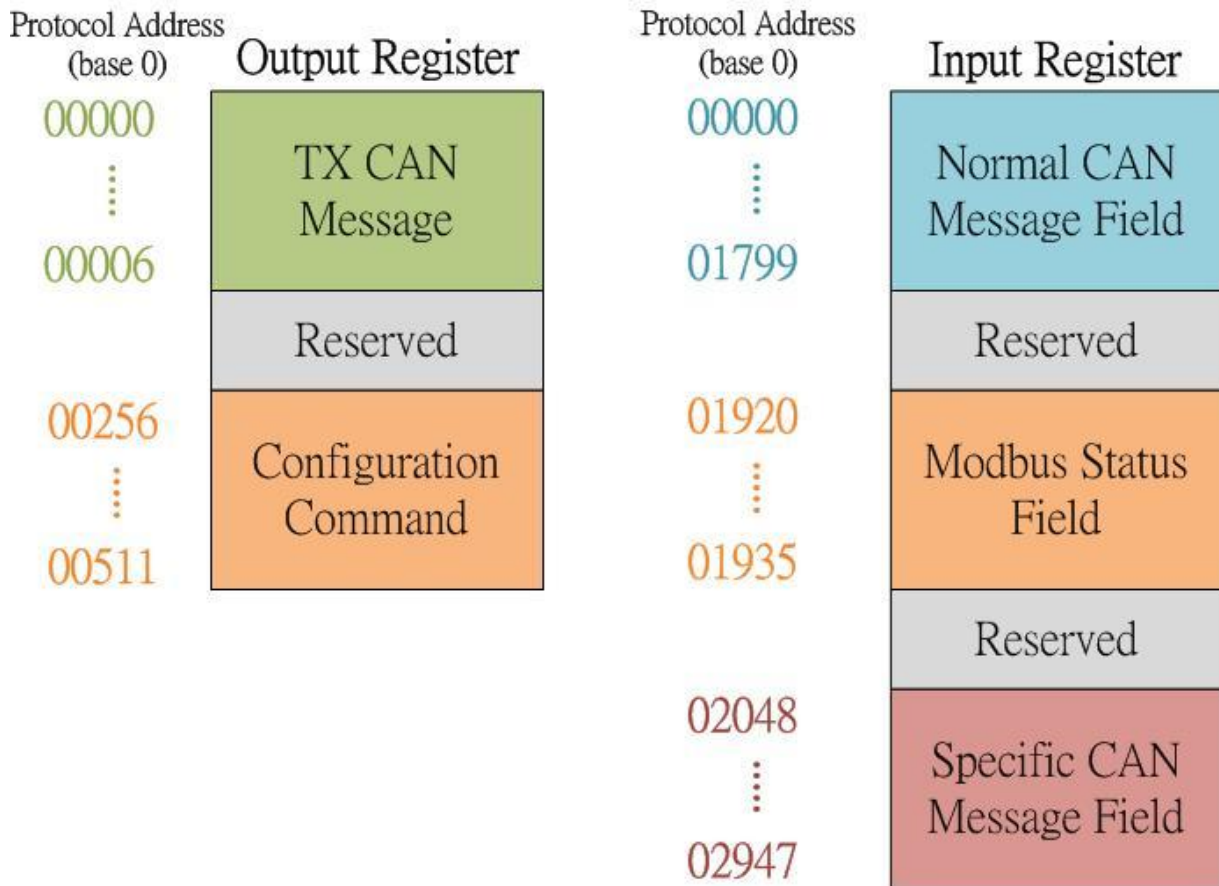

Figure 5-2: The address definition of Input Register and Output Register of the I-7530A-MR.

### Modbus Input Register:

#### (1) Normal CAN Message Field:

In this field, the address range of “Normal CAN Message” is 00000~01799 (protocol addresses). It is used to store the CAN message received from the CAN network. One CAN message will occupy 9-byte address space in the “Normal CAN Message” field. Therefore, it can store maximum 200 CAN messages. The detailed Modbus address arrangement of “Normal CAN Message” field is described as the table 5-2.



Table5-2: Modbus address arrangement of “Normal CAN Message” field.

Protocol Addresses (Base 0)	PLC Addresses (Base 1)	Word Count	Description
Decimal rule			
00000 ~ 00008	30001 ~ 30009	9	RX CAN Message #001
00009 ~ 00017	30010 ~ 30018	9	RX CAN Message #002
...	...	...	...
01782 ~ 01790	31783 ~ 31791	9	RX CAN Message #199
01791 ~ 01799	31792 ~ 31800	9	RX CAN Message #200

The format of each received CAN Message is described below:

Word number	Description
1	Bit 15: 0→valid data, 1→invalid data Bit 6~14: Reserved Bit 5: CAN Specification, 0→2.0A, 1→2.0B Bit 4: RTR, 0→No, 1→Yes Bit 0~3: Data length, value=0~8
2	Most significant two bytes of CAN identifier. (Big-endian)
3	Least significant two bytes of CAN identifier. (Big-endian)
4	The data 1 and data 2 of CAN data field.
5	The data 3 and data 4 of CAN data field.
6	The data 5 and data 6 of CAN data field.
7	The data 7 and data 8 of CAN data field.
8	Most significant two bytes of the RX timestamp message. (Big-endian)
9	Least significant two bytes of the RX timestamp message. (Big-endian)



(2) Module Status Field:

The I-7530A-MR's status information is defined in the following address. Users can use the Modbus RTU command (function code 04<sub>hex</sub>) to read these informations from the "Module Status" field.

Table5-3: Modbus address of "Modbus Status" field.

Protocol Addresses (Base 0)	PLC Addresses (Base 1)	Word Count	Description
Decimal rule			
01920	31921	1	Counter
01921	31922	1	Read Standard CAN baud rate configuration
01922~01923	31923~31924	2	Read user-defined CAN baud rate configuration
01924	31925	1	CAN state register
01925	31926	1	CAN error counter
01926	31927	1	CAN/UART overflow flag
01927	31928	1	Firmware version
01928~01932	31929~31933	5	Module name
01933~01935	31934~31936	3	Manufacturer

The detailed information of the "Module Status" field is described below.

Status Name	Description
Counter	The unread number of CAN message in the Normal CAN Message Field of Input Register.
Read Standard CAN baud rate configuration	The current baud rate setting of CAN bus. Please refer to Table 4-2 for more information.
Read user-defined CAN baud rate configuration	The current user-defined baud rate setting of CAN bus. Please refer to Table 4-8 for more information.
CAN state register	Most significant byte: Reserved. Least significant byte: register status. Please refer to Table 4-3 for more information.

CAN Error Counter	Most significant byte: CAN receive error counter. Least significant byte: CAN transmit error counter.
CAN/UART Overflow flag	Bit 0: CAN overflow flag, 0→Not full, 1→ Full. Bit 1: UART overflow flag, 0→Not full, 1→ Full.
Firmware Version	Most significant byte → major field of firmware version Least significant byte → minor field of firmware version For example, if the responded value is “01 02”. That means the firmware version is 1.02.
Module Name	“I-7530A-MR” in ASCII format.
Manufacturer	“ICPDAS” in ASCII format.

(3) Specific CAN Message Field:

The I-7530A-MR supports a “Specific CAN Message” field to store ten special CAN messages with specific the CAN IDs(Note1). When the I-7530A-MR receive the CAN messages whose CAN IDs are defined in the Specific CAN Message Field by the Utility tool, the I-7530A-MR put this CAN message into the corresponding register of the Specific CAN Message field. Each CAN message will occupy 9 address space of the register, and the range of this field is listed in following table.

Table5-4: Modbus address of “Specific CAN Message” field.

Protocol Address (Base 0)	PLC Address (Base 1)	Word Count	Description
Decimal rule			
02048~02056	32049~302057	9	Specific RX CAN Message #001
02057~02065	32058~32066	9	Specific RX CAN Message #002
...	...	...	
02129~02137	32130~32138	9	Specific RX CAN Message #010
02138~02147	32139~32148	9	Specific RX CAN Message #011 (Note1)
...	...	...	...
02930~02938	32931~32939	9	Specific RX CAN Message #099 (Note1)
02939~02947	32940~32948	9	Specific RX CAN Message #100 (Note1)

Note1:

1. firmware v1.02 (or later) support #011 to #100
2. After saving all configuration into an “ini” file (section3.2.8), there will create an “I7530AMR\_SpecCANID\_MBTable.txt” on the Utility folder.

This file is a mapping table for specific CAN ID and Modbus address.

## Modbus Output Register:

There are two fields on Modbus output register, one is TX CAN message field and the other is Configuration command field. The addresses of these fields are described below.

Table5-5: Modbus output register address

Protocol Address (Base 0)	PLC Address (Base 1)	Description
Decimal rule		
00000 ~ 00006	40001 ~ 40007	TX CAN Message
00256 ~ 00511	40257 ~ 40512	Configuration command

### (1) TX CAN Message Field:

The “TX CAN Message” in the Modbus Output Register is used to stored a CAN message which will be transmitted to the CAN network.

The TX CAN Message formats are described below:

Word number	Description
1	Bit 6~15: Reserved Bit 5: CAN Specification, 0→CAN 2.0A, 1→CAN 2.0B Bit 4: RTR, 0→No, 1→Yes Bit 0~3: Data length, value = 0~8
2	Most significant two bytes of CAN Identifier. (Big endian)
3	Least significant two bytes of CAN Identifier. (Big endian)
4	The data 1 and data 2 of CAN data field.
5	The data 3 and data 4 of CAN data field.
6	The data 5 and data 6 of CAN data field.
7	The data 7 and data 8 of CAN data field.

---

(2) Configuration command Field:

The “Configuration command” in the Modbus Output Register is used for user to use Modbus command to configure module, including reboot module, reset CAN bus, change RS-232/RS-422/RS-485 setting, change CAN bus baud rate, change user-defined CAN baud rate.

These configuration commands are described below:

### 1. Reboot Module

This command is used to reboot module. After successfully setting, the module will response a successful setting message, and then reboots.

Request command:

Field Name	Size	Value Range	Example
Hexadecimal rule			
Node ID	1 byte	0x01~0xF7	0x01
Function Code	1 byte	0x10	0x10
Start Address	2 bytes	0x0100	0x0100
Word Count	2 bytes	0x0002	0x0002
Byte Count	1 byte	0x04	0x04
Data-1	2 bytes	0x0001 (Note1)	0x0001
Data-2	2 bytes	0x0001 (Note2)	0x0001

Note1: This value is command field.

Note2: Except 0001<sub>hex</sub>, other values are useless

Response command:

Field Name	Size	Value Range	Response Example
Hexadecimal rule			
Node ID	1 byte	0x01~0xF7	0x01
Function Code	1 byte	0x10	0x10
Start Address	2 bytes	0x0100	0x0100
Word Count	2 bytes	0x0002	0x0002

---

## 2. Reset CAN bus

This command is used to reset CAN bus of module. After successfully setting, the module will response a successful setting message.

Request command:

Field Name	Size	Value Range	Example
Hexadecimal rule			
Node ID	1 byte	0x01~0xF7	0x01
Function Code	1 byte	0x10	0x10
Start Address	2 bytes	0x0100	0x0100
Word Count	2 bytes	0x0002	0x0002
Byte Count	1 byte	0x04	0x04
Data-1	2 bytes	0x0002(Note1)	0x0002
Data-2	2 bytes	0x0001(Note2)	0x0001

Note1: This value is command field.

Note2: Except 0001<sub>hex</sub>, other values are useless

Response command:

Field Name	Size	Value Range	Response Example
Hexadecimal rule			
Node ID	1 byte	0x01~0xF7	0x01
Function Code	1 byte	0x10	0x10
Start Address	2 bytes	0x0100	0x0100
Word Count	2 bytes	0x0002	0x0002

### 3. Change RS-232/RS-422/RS-485 setting

This command is used to Change RS-232/RS-422/RS-485 setting. After successfully setting, the module will response a successful setting message, and then reboots.

Request command:

Field Name	Size	Value Range	Example
Hexadecimal rule			
Node ID	1 byte	0x01~0xF7	0x01
Function Code	1 byte	0x10	0x10
Start Address	2 bytes	0x0100	0x0100
Word Count	2 bytes	0x0005	0x0005
Byte Count	1 byte	0x0A	0x0A
Data-1	2 bytes	0x0003 (Note1)	0x0003
Data-2	2 bytes	0x0002~0x000C (Note2)	0x000B (115200 bps)
Data-3	2 bytes	0x0000~0x0003 (Note3)	0x0000 (8)
Data-4	2 bytes	0x0000~0x0001 (Note4)	0x0001 (1)
Data-5	2 bytes	0x0000~0x0002 (Note5)	0x000 (N)

Note1: This value is command field.

Note2: This value is baud rate of RS-232/RS-422/RS-485.

Baud rate	Description
Hexadecimal rule	
0x0002	300 bps baud rate of RS-232/RS-422/RS-485.
0x0003	600 bps baud rate of RS-232/RS-422/RS-485.
0x0004	1200 bps baud rate of RS-232/RS-422/RS-485.
0x0005	2400 bps baud rate of RS-232/RS-422/RS-485.
0x0006	4800 bps baud rate of RS-232/RS-422/RS-485.
0x0007	9600 bps baud rate of RS-232/RS-422/RS-485.
0x0008	19200 bps baud rate of RS-232/RS-422/RS-485.
0x0009	38400 bps baud rate of RS-232/RS-422/RS-485.
0x000A	57600 bps baud rate of RS-232/RS-422/RS-485.



0x000B	115200 bps baud rate of RS-232/RS-422/RS-485.
0x000C	230400 bps baud rate of RS-232/RS-422/RS-485.

Note3: This value is Data bit of RS-232/RS-422/RS-485.

Data bit	Description
Hexadecimal rule	
0x0000	5 bits Data formation
0x0001	6 bits Data formation
0x0002	7 bits Data formation
0x0003	8 bits Data formation

Note4: This value is Stop bit of RS-232/RS-422/RS-485.

Stop bit	Description
Hexadecimal rule	
0x0000	1 Stop bit
0x0001	2 Stop bits

Note5: This value is Parity of RS-232/RS-422/RS-485.

Parity	Description
Hexadecimal rule	
0x0000	None
0x0001	Odd
0x0002	Even

Response command:

Field Name	Size	Value Range	Response Example
Hexadecimal rule			
Node ID	1 byte	0x01~0xF7	0x01
Function Code	1 byte	0x10	0x10
Start Address	2 bytes	0x0100	0x0100
Word Count	2 bytes	0x0005	0x0002

---

## 4. Change CAN bus baud rate

This command is used to Change CAN bus baud rate. After successfully setting, the module will response a successful setting message, and then reboots.

Request command:

Field Name	Size	Value Range	Example
Hex rule			
Node ID	1 byte	0x01~0xF7	0x01
Function Code	1 byte	0x10	0x10
Start Address	2 bytes	0x0100	0x0100
Word Count	2 bytes	0x0002	0x0002
Byte Count	1 byte	0x04	0x04
Data-1	2 bytes	0x0004 (Note1)	0x0004
Data-2	2 bytes	0x0000~0x0008, 0x000F (Note2)	0x0008 (1000kbps)

Note1: This value is command field.

Note2: This value is baud rate of CAN bus.

B	Description
0x0000	10 kbps baud rate of CAN
0x0001	20 kbps baud rate of CAN
0x0002	50 kbps baud rate of CAN
0x0003	100 kbps baud rate of CAN
0x0004	125 kbps baud rate of CAN
0x0005	250 kbps baud rate of CAN
0x0006	500 kbps baud rate of CAN
0x0007	800 kbps baud rate of CAN
0x0008	1000 kbps baud rate of CAN
0x000F	User-defined baud rate of CAN

---

Response command:

Field Name	Size	Value Range	Response Example
Hexadecimal rule			
Node ID	1 byte	0x01~0xF7	0x01
Function Code	1 byte	0x10	0x10
Start Address	2 bytes	0x0100	0x0100
Word Count	2 bytes	0x0002	0x0002

---

## 5. Change user-defined CAN bus baud rate

This command is used to Change user-defined CAN bus baud rate. After successfully setting, the module will response a successful setting message, and then reboots.

Request command:

Field Name	Size	Value Range	Example
Hex rule			
Node ID	1 byte	0x01~0xF7	0x01
Function Code	1 byte	0x10	0x10
Start Address	2 bytes	0x0100	0x0100
Word Count	2 bytes	0x0003	0x0003
Byte Count	1 byte	0x06	0x06
Data-1	2 bytes	0x0005 (Note1)	0x0005
Data-2	2 bytes	(Note2)	0x0001
Data-3	2 bytes	(Note2)	0x4585

Note1: This value is command field.

Note2: This value is user-defined CAN baud rate.

Example:

If users want to use CAN bus baud rate of 83.333 kbps. They can set CAN bus baud rate into Data-2 and Data-3 field. Please refer to step 1~3 for details.

Step 1:

Multiply the CAN baud rate value by 1000.

$83.333 \text{ kbps} = 83.333 * 1000 = 83333 \text{ bps (Decimal)}$

Step 2:

Change this decimal value to 2 words hexadecimal value.

$83333(\text{Decimal}) = 0x00014585(\text{Hexadecimal})$

Step 3:

Fill Data-2 and Data-3 field with hexadecimal values (0x00014585) by using Big-endian format.

Response command:

---

Field Name	Size	Value Range	Response Example
Hexadecimal rule			
Node ID	1 byte	0x01~0xF7	0x01
Function Code	1 byte	0x10	0x10
Start Address	2 bytes	0x0100	0x0100
Word Count	2 bytes	0x0003	0x0003

## 5.2.1 Using Modbus RTU command to get a CAN Message

When the I-7530A-MR is set to the Modbus Slave mode, each CAN message (except the CAN message whose CAN IDs are defined in the Specific CAN Message field) received from the CAN network will be stored into the “Normal CAN Message” field. Users can use the Modbus RTU command (function code 04<sub>hex</sub>) to read the CAN message from the “Normal CAN Message” field (refer to table 5-2.). The start address of each command must be set to 0000<sub>hex</sub> and the data length field must be a multiple of 9 because one CAN message uses 9 address space. After reading the registers by the Modbus command, the content of the registers of the read CAN message is covered by the unread CAN message which will be read next.

Example1:

Use Modbus RTU command (function code 04<sub>hex</sub>) to read one CAN message:

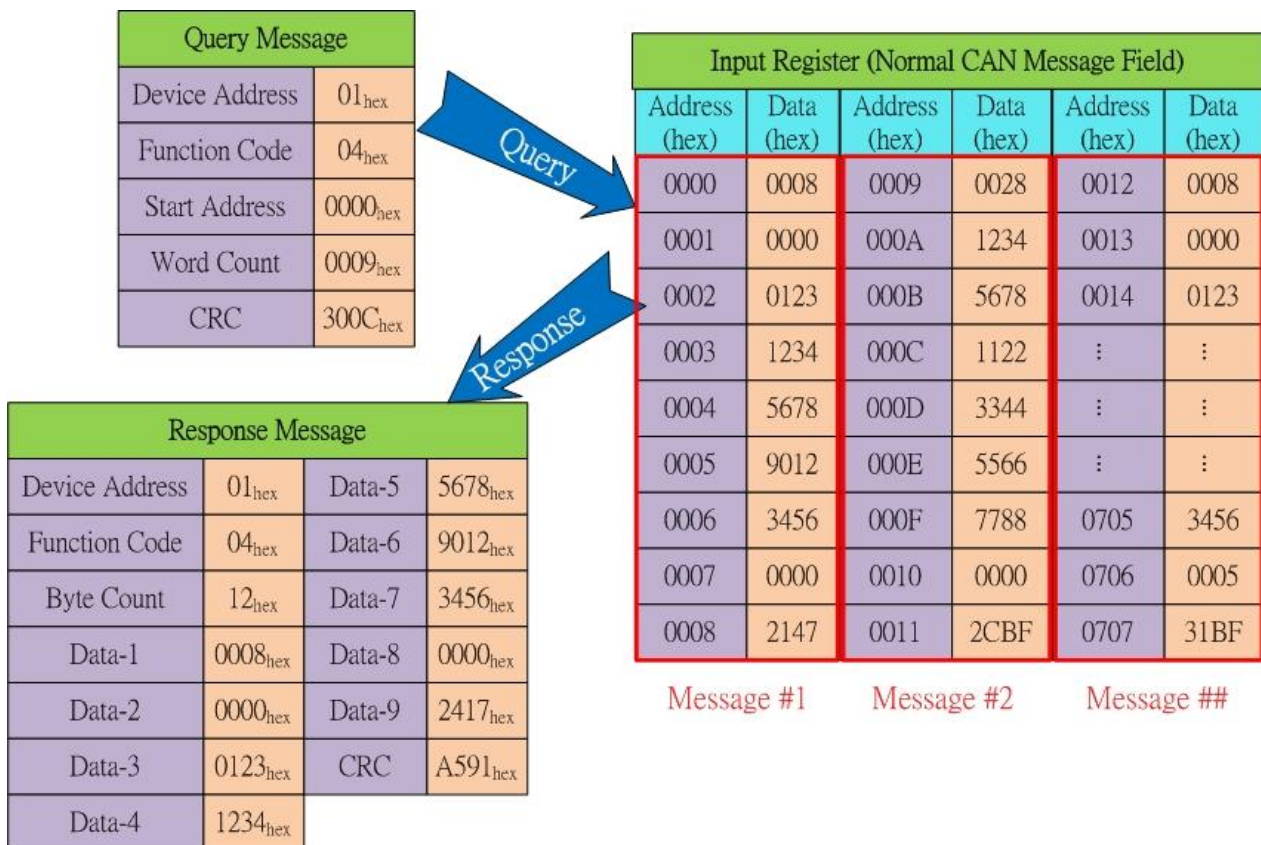

Figure 5-3: Use the Modbus command to read one CAN message.

Example2:

Use Modbus RTU command (function code 04<sub>hex</sub>) to read two CAN messages:

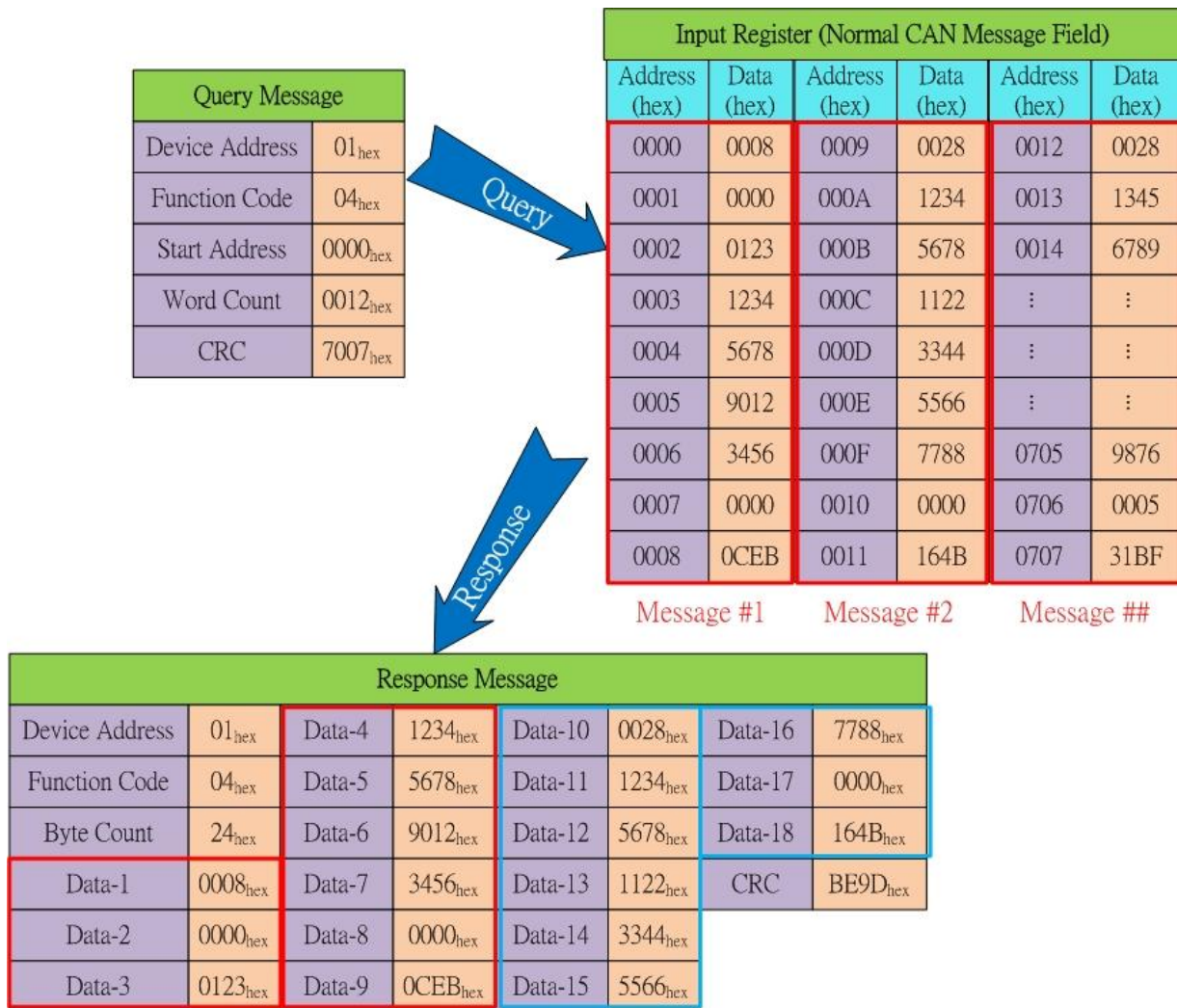

Figure 5-4: Use the Modbus command to read two CAN message.



## 5.2.2 Using Modbus RTU command to send a CAN message

If users need to send CAN messages via the Modbus RTU commands, users need to send the Modbus RTU command with the “TX CAN message” format to the Output Register of the I-7530A-MR. Then the I-7530A-MR will transfer this command to a CAN message format and send it to the buffer of the CAN controller. The CAN controller will send the CAN message automatically which the CAN bus is idle. There are two method for transmitting a CAN message via Modbus RTU command and this manual will illustrate them at next sectn.

### 5.2.2.1 Using function Code 10<sub>hex</sub> to send a CAN message

Users can use Modbus RTU commands (function code 10<sub>hex</sub>) to transmit a CAN message by writing the Output Register of the I-7530A-MR (the data format must follow the table 5-5). The start address of the Modbus command is always 0000<sub>hex</sub>, and the Word count and Byte count are always 07<sub>hex</sub> and 0D<sub>hex</sub> respectively.

Example:

Use the Modbus RTU command (function code 10<sub>hex</sub>) to transmit a CAN message to the CAN network:

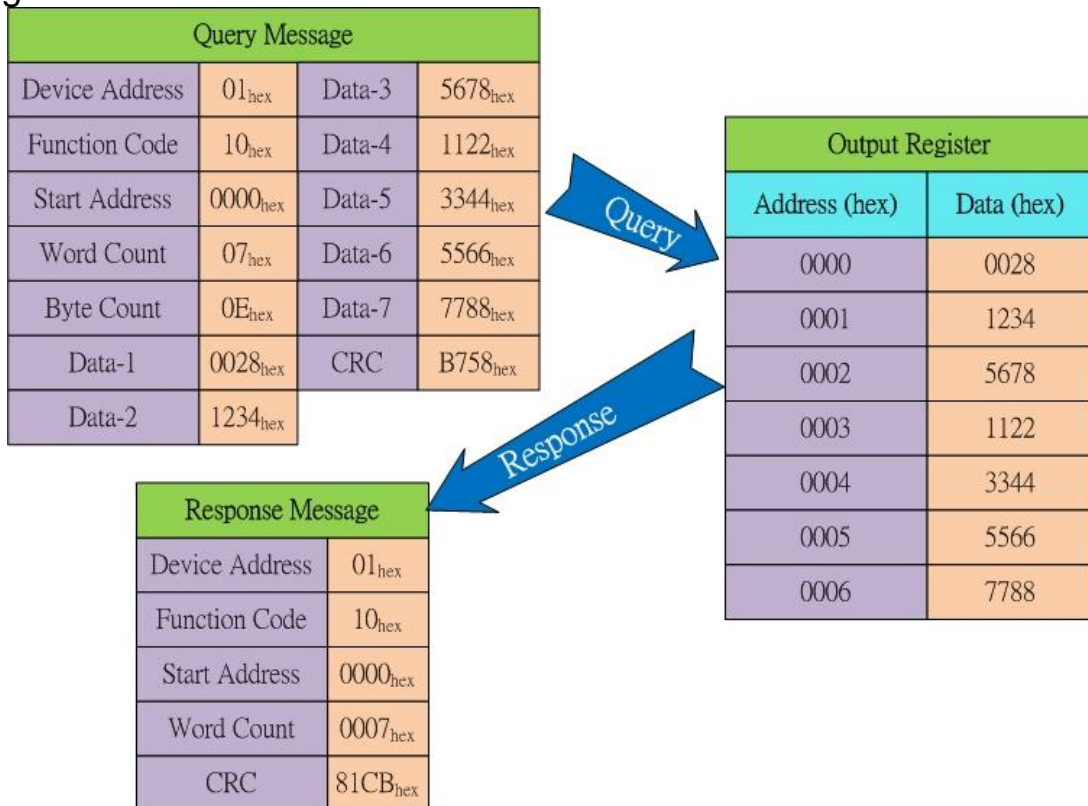

Figure 5-5: Transmit a CAN message.

Users can use the Modbus RTU command with function code 03<sub>hex</sub> to read the transmitted CAN message. The start address of the command is always 0000<sub>hex</sub>, and the data length field must be set to 0007<sub>hex</sub>.

Example:

Use the Modbus RTU command (function code 03<sub>hex</sub>) to read the transmitted CAN message format from the Output Register:

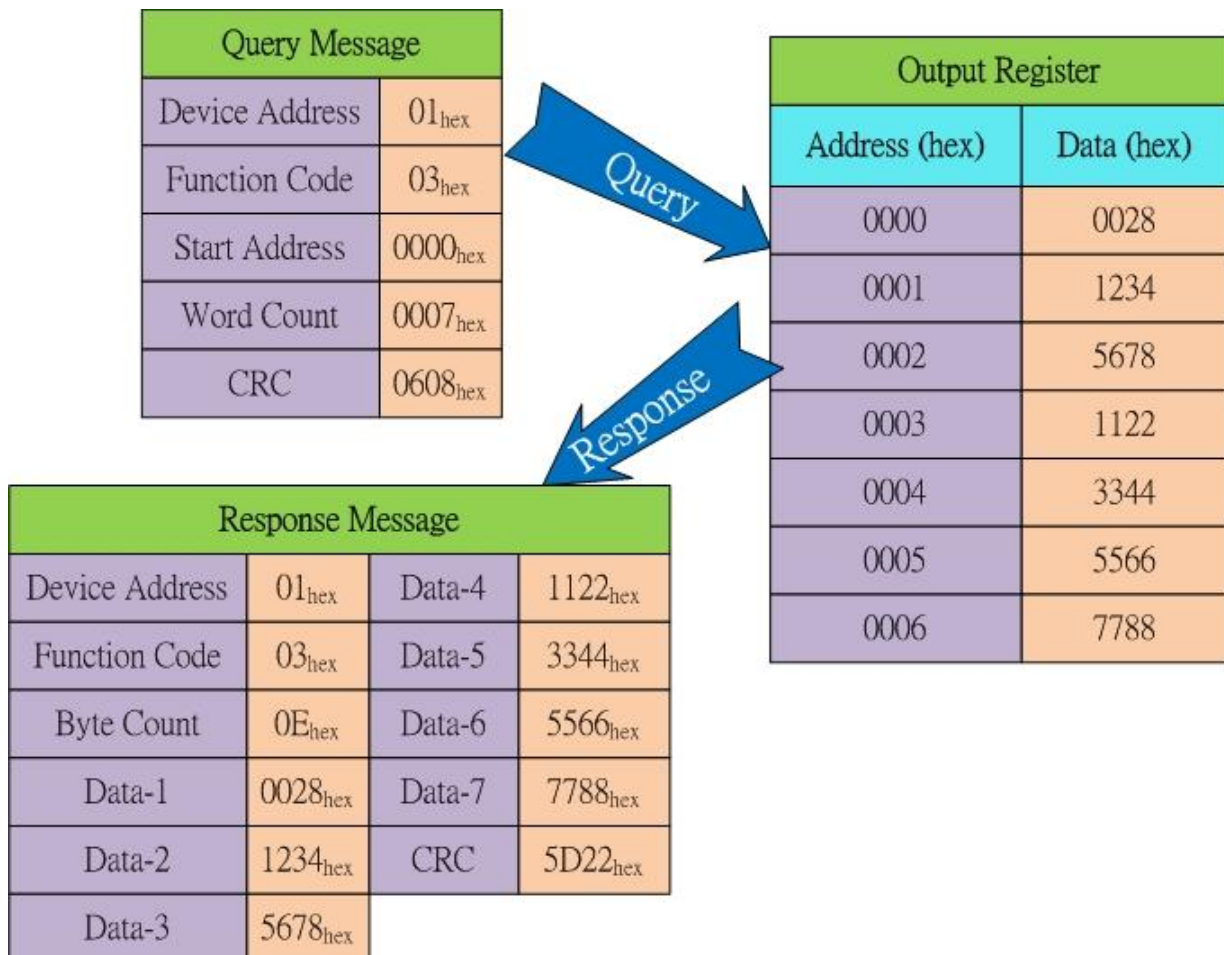
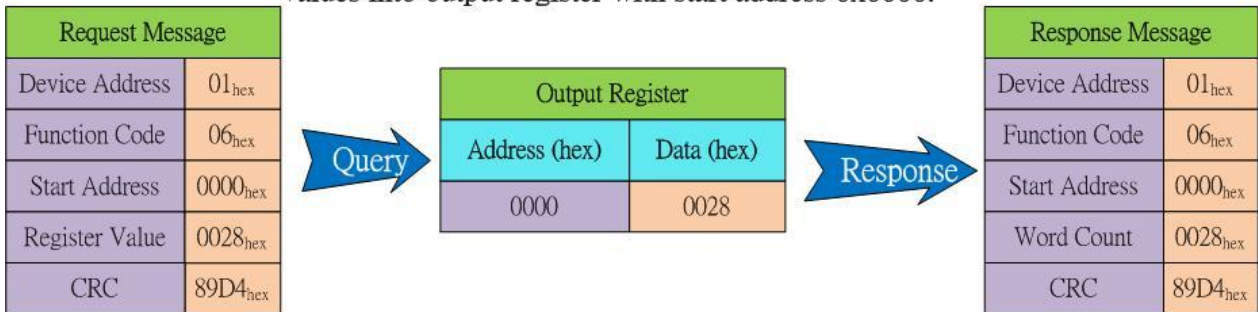

Figure 5-6: Use the Modbus RTU command (function code 03<sub>hex</sub>) to read the transmitted CAN message format.

### 5.2.2.2 Using function Code 06<sub>hex</sub> to send a CAN message

Users can use Modbus RTU commands (function code 06<sub>hex</sub>) to transmit a CAN message by writing the Output Register of the I-7530A-MR (the data format must follow the table 5-5). The start address of the Modbus command is always 0000<sub>hex</sub>. Using function code 06<sub>hex</sub> to transmit a CAN message is divided into 8 steps. Following, this manual will use an example to illustrate how to transmit a CAN message via function Code 06<sub>hex</sub>. When you want to transmit a CAN message, you must fill output bytes with TX CAN Message formats according to order of priority. For example: If you want to transmit a CAN message with CAN ID 0x12345678, 8 bytes Data 0x11, 0x22, 0x33, 0x44, 0x55, 0x66, 0x77, and 0x88, the setting is as following:

1. Write the CAN specification, RTR, Data Length values into output register with start address 0x0000.



2. Write the most significant two bytes of CAN identifier into output register with start address 0x0001. (Big-endian)

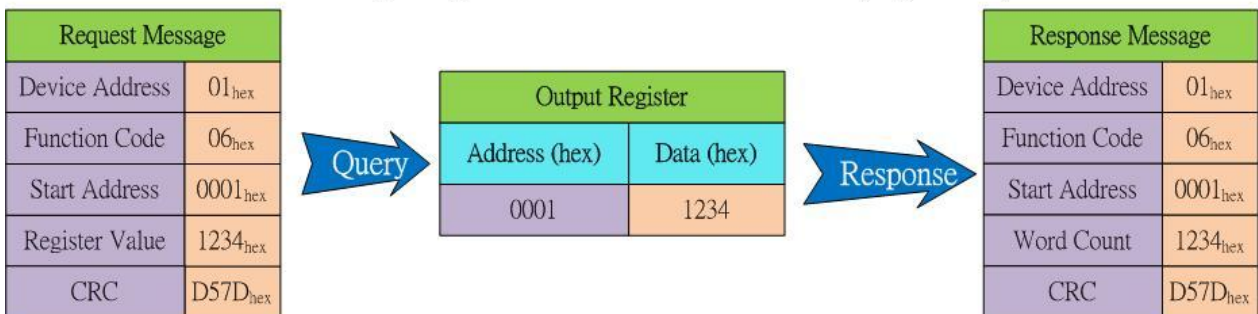

3. Write the least significant two bytes of CAN identifier into output register with start address 0x0002. (Big-endian)

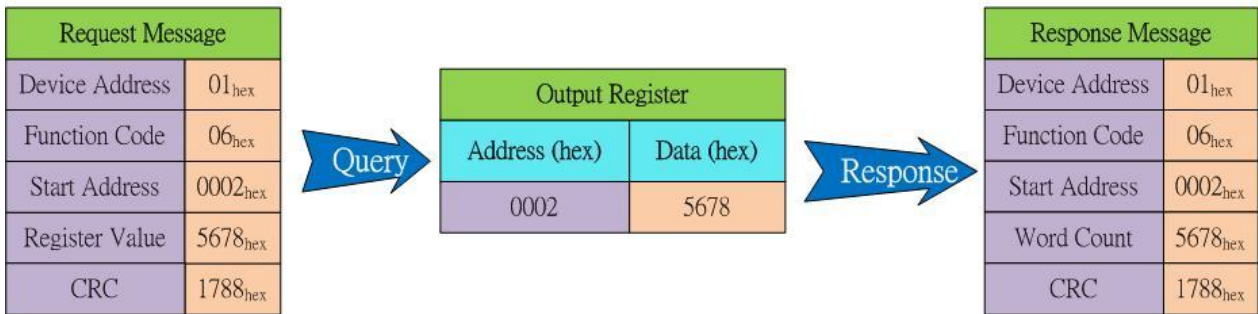

4. Write CAN data1 and data2 into output register with start address 0x0003.

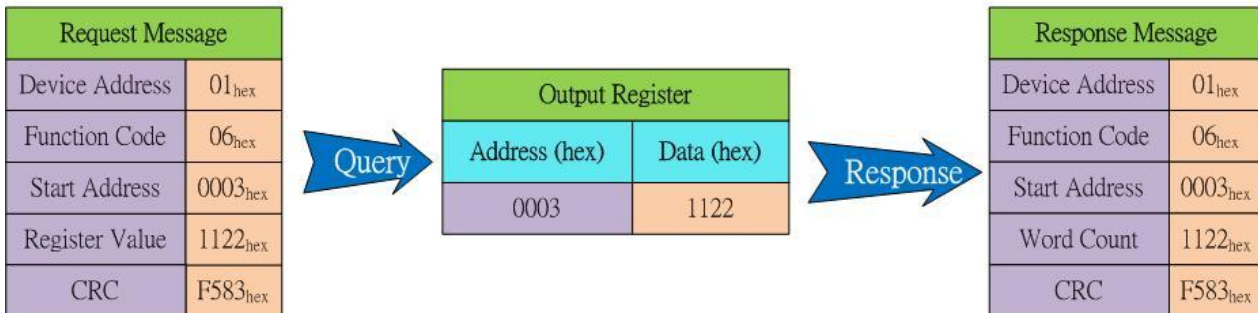

5. Write CAN data3 and data4 into output register with start address 0x0004.

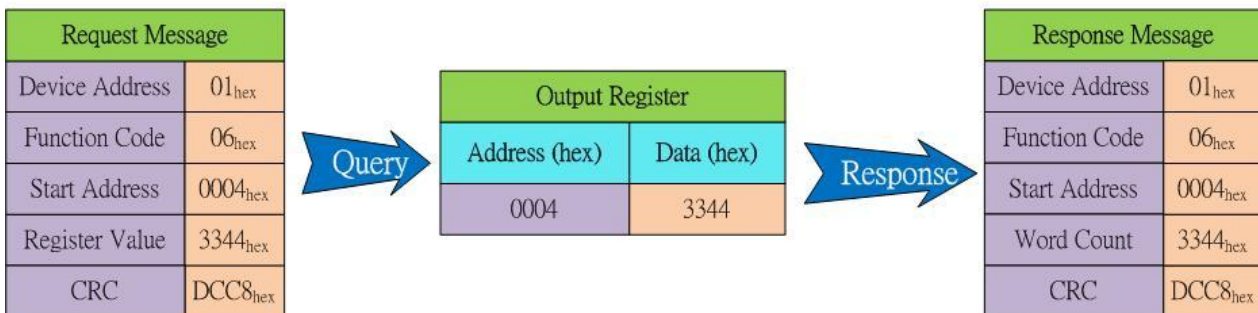

6. Write CAN data5 and data6 into output register with start address 0x0005.

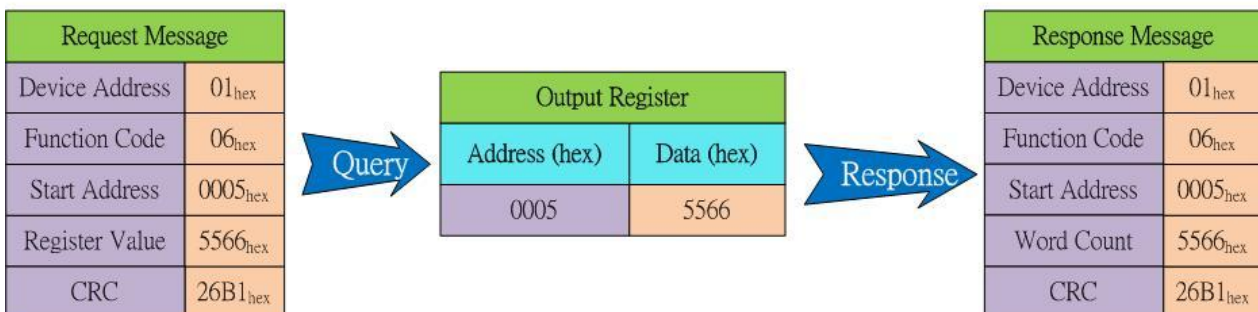



7. Write CAN data7 and data8 into output register with start address 0x0006.

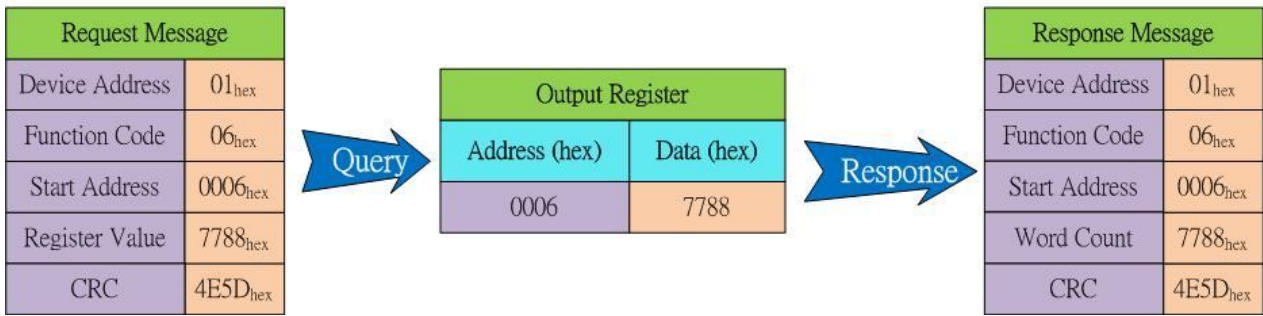

8. Write the register value into output register with start address 0x0007 and the CAN message will be transmitted. If you want to transmit the same CAN message, you just change the register value and write it into this output register again. If you want to transmit other CAN message, you must repeat the steps 1~8.

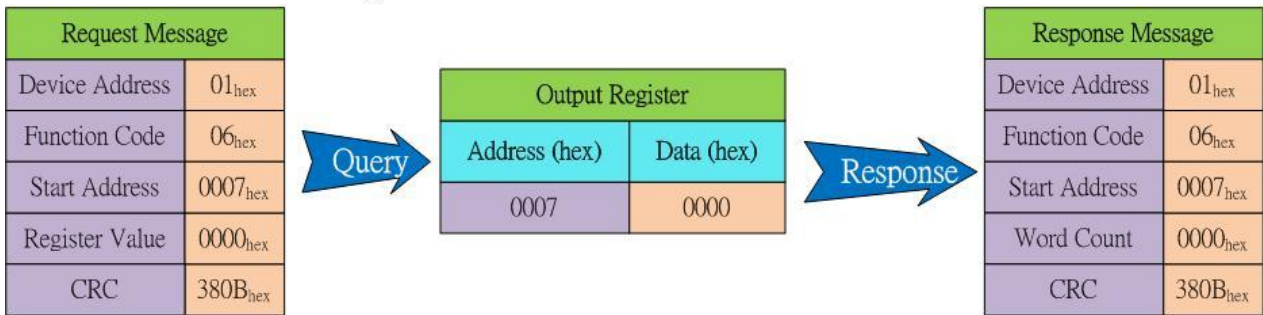

Note: Using function code 03<sub>hex</sub> to read a output CAN message is not allowed when you use this method to transmit a CAN message.

### 5.2.3 Using Modbus RTU command to get a Specific CAN Message

The I-7530A-MR supports a “Specific CAN Message” field to get the expected ten specific CAN messages (firmware v1.02 or later support 100 CAN ID of CAN messages). When receiving a CAN message whose CAN ID is defined in the Specific CAN Message by the Utility tool, the I-7530A-MR will save this CAN message to the “Specific CAN Message” field.

Users can use the Modbus RTU command (function code 04<sub>hex</sub>) to directly read the CAN message from this field. It is usually used to get the important CAN messages immediately. The start address of the command must be the same as the start address defined in the Specific CAN Message field, and the data length field must be a multiple of 9.

Example:

Use the Modbus RTU command (function code 04<sub>hex</sub>) to read the specific CAN message from the “Specific CAN Message” field:

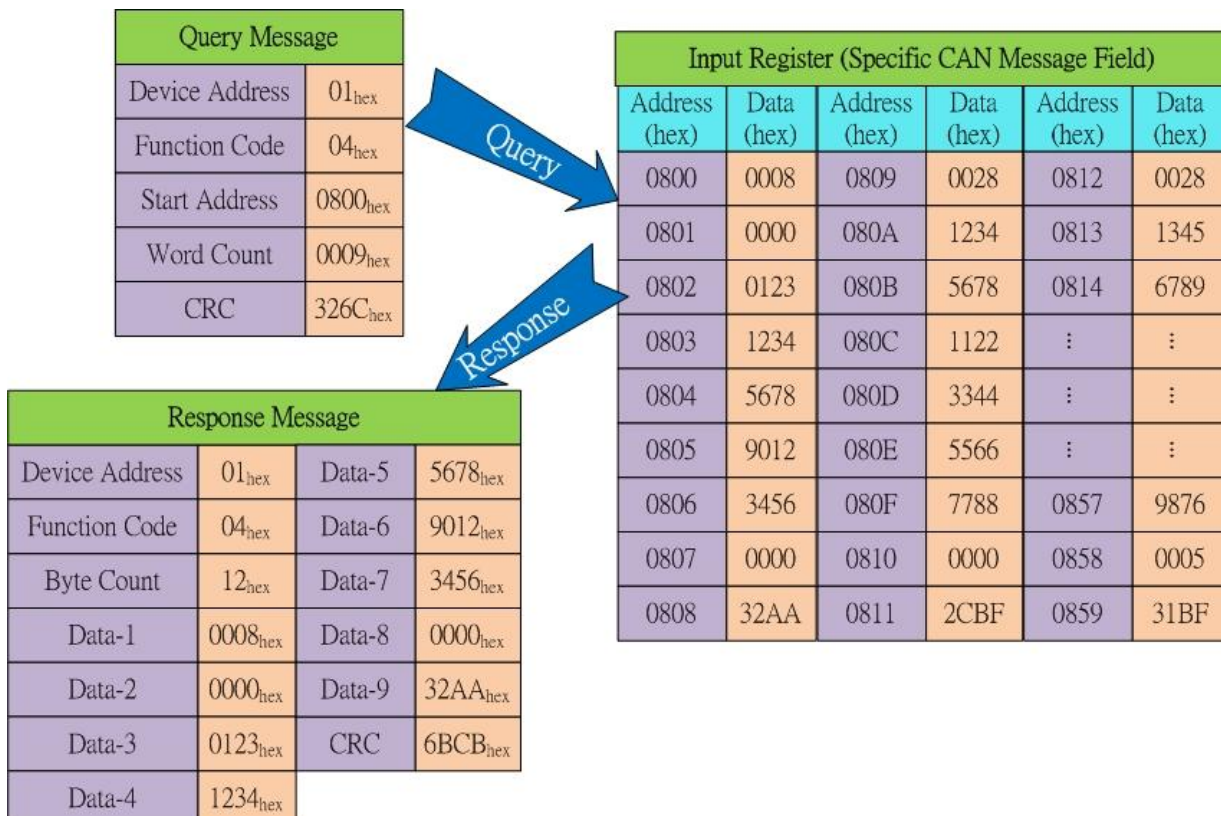

Figure 5-7: Use the Modbus command to read specific CAN message.

## 5.2.4 Using Modbus RTU command to configure module

I-7530A-MR supports five Modbus RTU commands (function code 10<sub>hex</sub>) of configuring module, including reboot module, reset CAN bus, change RS-232/RS-422/RS-485 setting, change CAN bus baud rate, and change CAN bus user-defined baud rate. These commands use start address 0100<sub>hex</sub>.

Example: Using Modbus RTU command to reboot module.

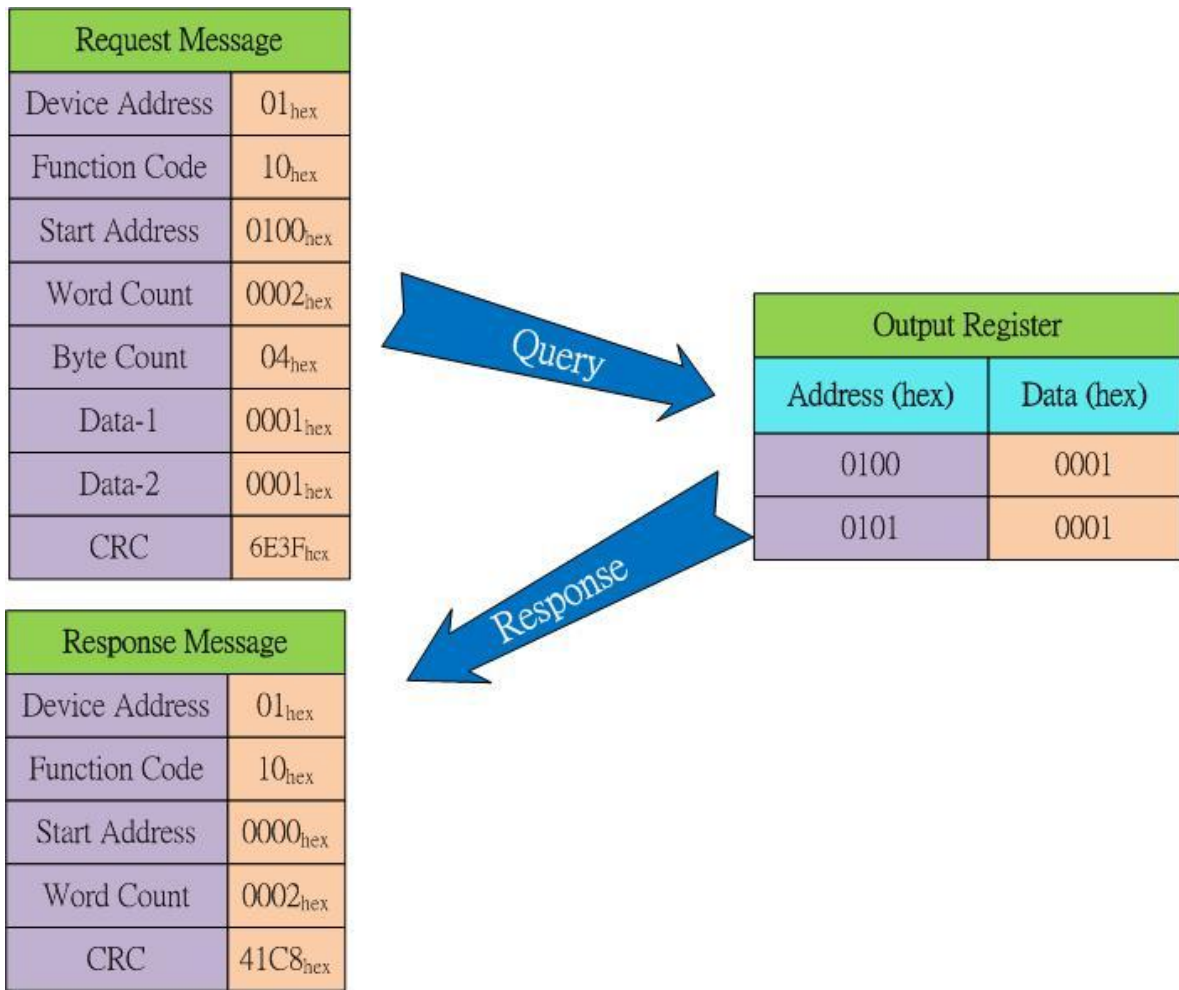

Figure 5-8: Using Modbus RTU command to reboot module



Example: Using Modbus RTU command to change user-defined CAN bus baud rate.

User-defined CAN baud rate:  $83.333 * 1000 = 83333$  (Dec) =  $00014585$  (hex)

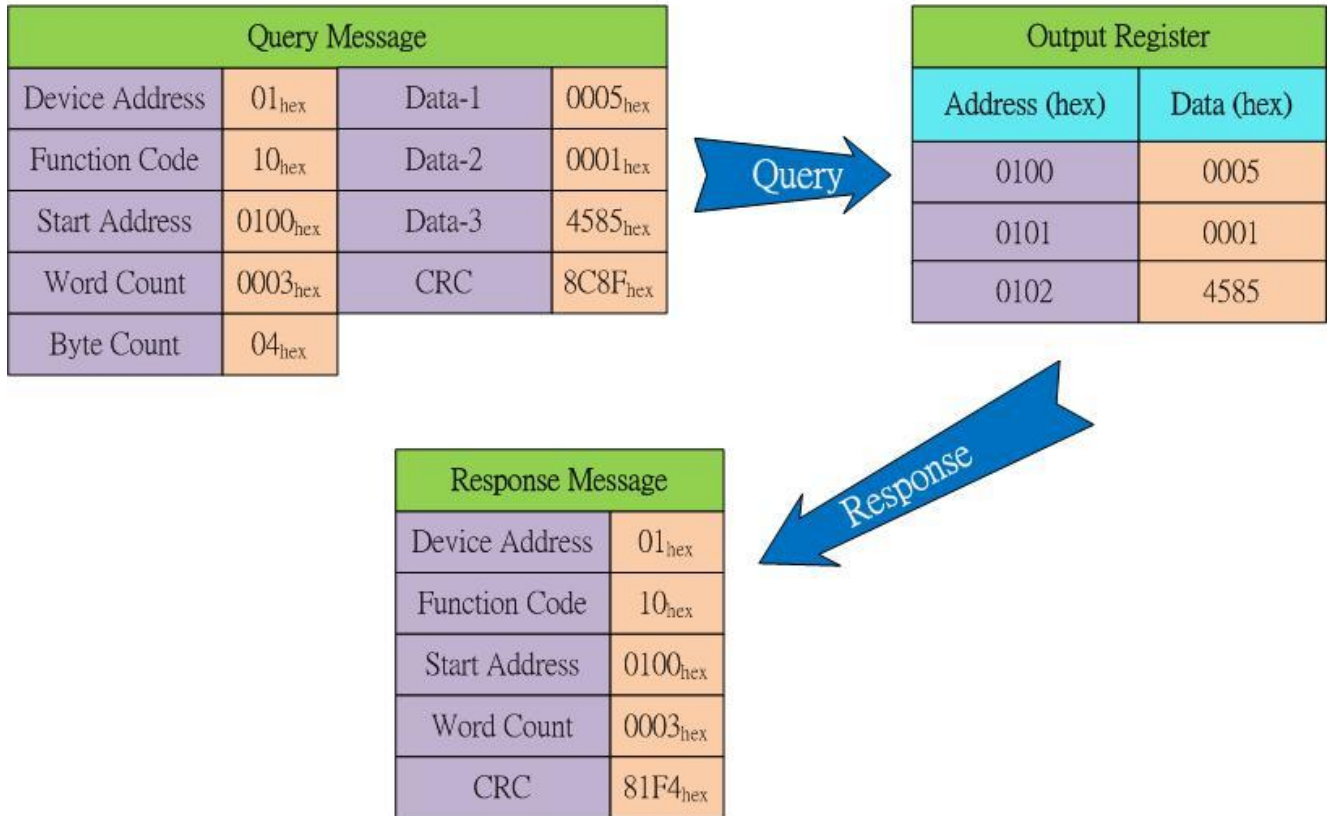

Figure 5-9: Using Modbus RTU command to change user-defined CAN baud rate.

---

## 5.3 Modbus Exception Codes

The following table lists the Modbus Exception codes that the I-7530A-MR supports.

Table 5-6: Error code table

code	Description	Possible causes & solutions
1	Illegal function	The function code is not an allowable action for the I-7530A-MR.
2	Illegal Data Address	The data address is not allowed for the I-7530A-MR.
3	Illegal Data Value	The number of register or byte count is not an allowed or no any CAN message is stored in the "Normal CAN Message" field for the I-7530A-MR.
6	Slave Device Busy	The transmission buffer overrun is happened, users should retransmit the message later when this module is normal.

---

## 6. Modbus Master Mode

To compare with the chapter 5, this section will introduce the Modbus master mode of the I-7530A-MR. Via this function, the I-7530A-MR can act as a Modbus master to CAN module. Following, this sector will illustrate how to configure and how to operate the function in detail.

Note: This function is supported by firmware version v1.11 or later.

### 6.1 Supported Modbus Functions

The Modbus Master function supports Modbus function code: 0x01, 0x02, 0x03, 0x04, 0x05, 0x06, 0x0F, and 0x10. The following table will describe in detail.

Table 6-1: Supported Modbus Function Codes

Modbus command	Function Code	Function Name	Description
Modbus <b>Read</b> command	1 (01 Hex)	Read Coil Status	Read Coil Status from slave device.
	2 (02 Hex)	Read Input Status	Read Input Status from slave device.
	3 (03 Hex)	Read AO Holding Registers	Read AO Holding Registers from slave device.
	4 (04 Hex)	Read AI Registers	Read AI Registers from slave device.
Modbus <b>Write</b> command	5 (05 Hex)	Write Single Coil	Write Single Coil from slave device.
	6 (06 Hex)	Write Signal Register	Write Single Register from slave device.
	15 (0F Hex)	Write Multiple Coil	Write Multiple Coil from slave device.
	16 (10 Hex)	Write Multiple Registers	Write Multiple Registers from slave device.

## 6.2 IO Memory Size

The Modbus Master function uses two memory spaces for storing input data from Modbus slave and output data from CAN device. One is called “Read Memory Space” and the other is called “Write Memory Space”. Both of these two input/output data spaces are maximum 2048 bytes.

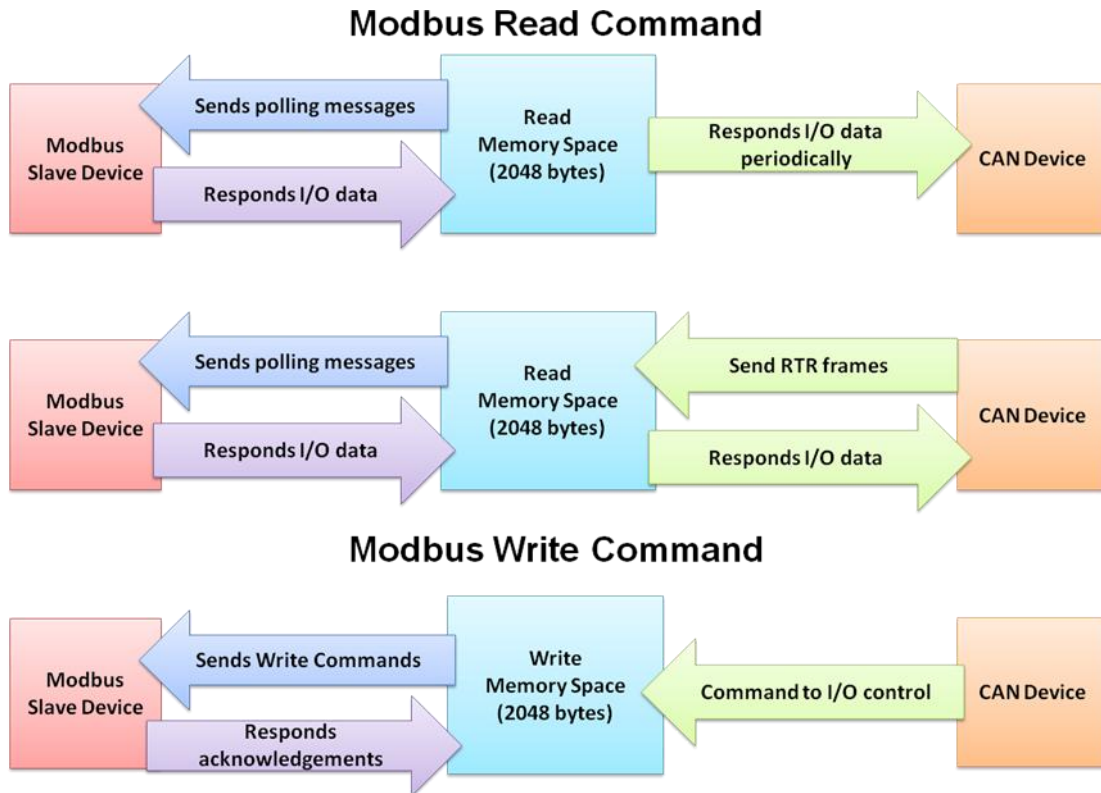

## 6.3 Configuration and Operation

The utility provides the new configuration interface for Modbus Master setting. When the user selected the communication mode for Modbus master function, the configuration interface will be pop-up.

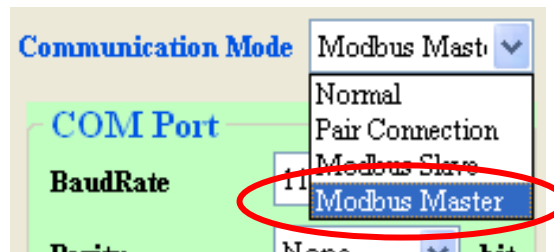

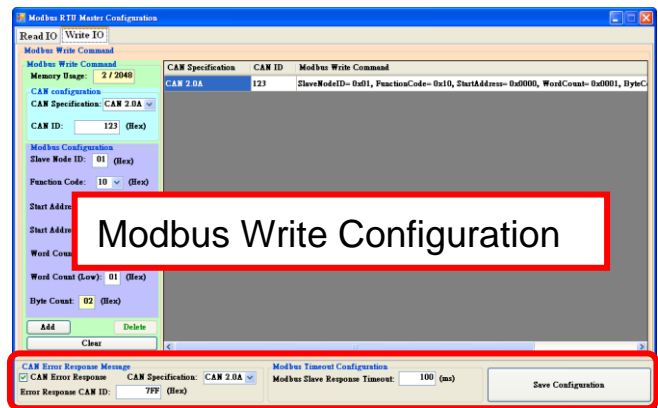
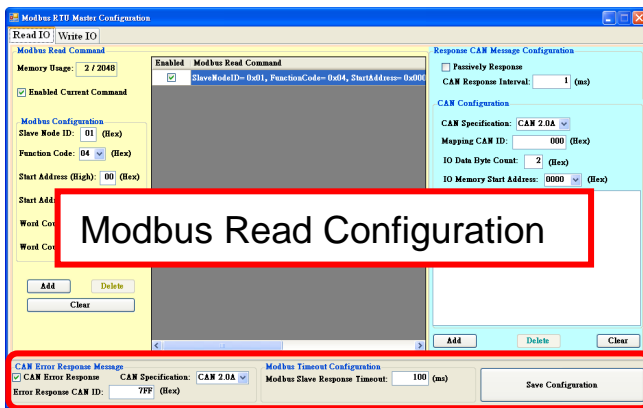

Common Configuration

The above screenshots are the operating interface of the I-7530A-MR Modbus Master configuration. The operating interface is divided into three parts “Modbus Read Configuration”, “Modbus Write Configuration”, and “Common Configuration”.

### 6.3.1 Modbus Read Configuration

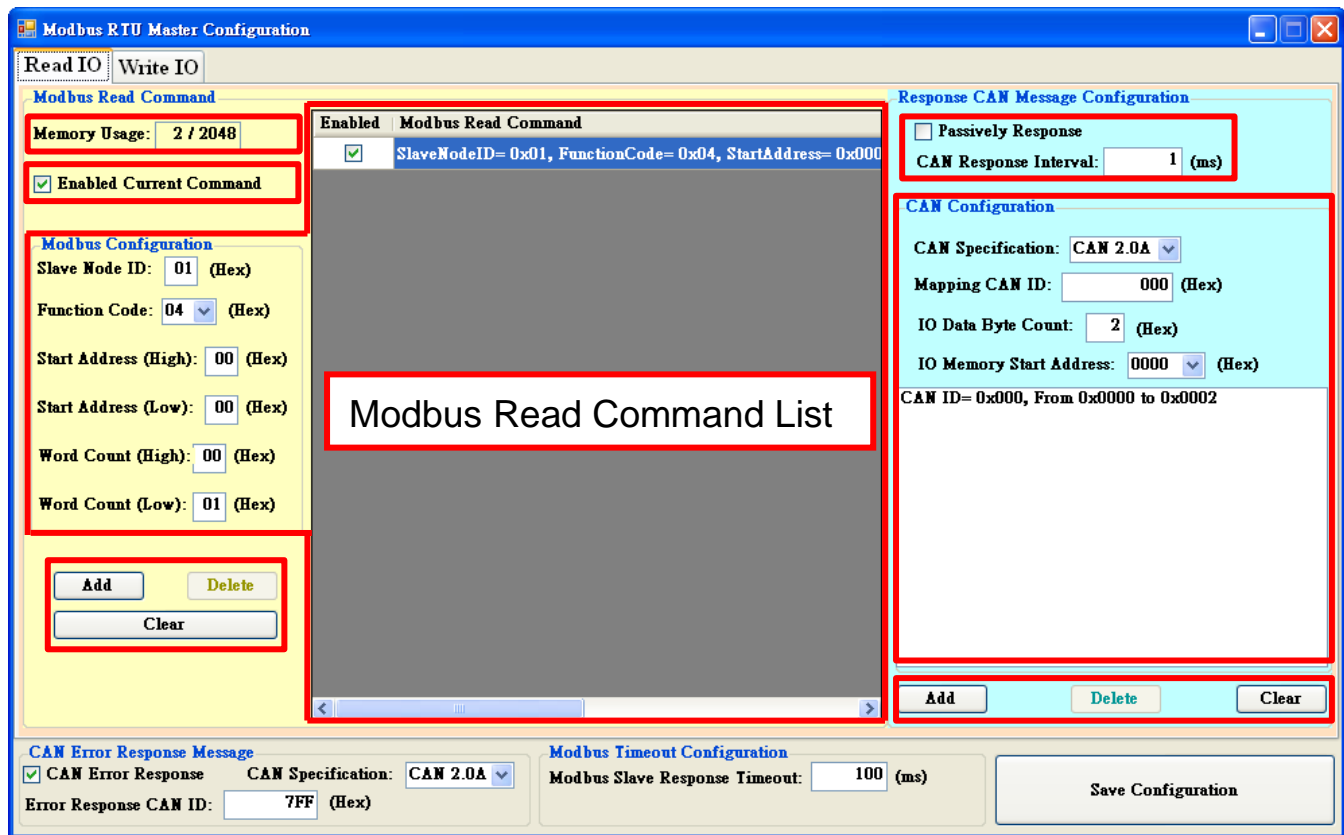

This page is used for configuring “Modbus Read Command” and “Response CAN Message”. The major purpose of the “Modbus Read Command” is access Modbus slave device via “Modbus Read Coil” or “Modbus Read Registers” command. And the major purpose of the “Response CAN Message” is used to response CAN message with I/O data which is read from Modbus slave device via “Modbus Read Command”.

### 6.3.1.1 Modbus Read Command

The “Modbus Read Command” is divided into several parameters. Following, we will illustrate how to configure and operate the “Modbus Read Command”.

#### ◆ Memory Usage:

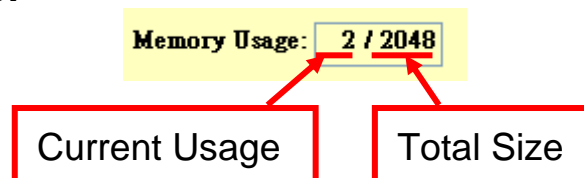

This field indicates the usage of “Read Memory Space”. As section 6.2 description, the total memory size is 2048. The meaning of this field is “current usage / total size”, which unit is byte.

#### ◆ Enabled Current Command:

Enabled Current Command

This field is used to decide whether the current command is used in operation mode or not. You can enable or disable this Modbus read command after you selected a command from the command list.

#### ◆ Modbus Configuration:

As we know, the Modbus Read Coil/Registers format is as following.

Node ID	Function Code	Start Address	Start Address	Bit/Word Count	Bit/Word Count	CRC	CRC

In order to fit Modbus Read Coil/Registers format, the Modbus configuration interface is designed as following:

**Modbus Configuration**

Slave Node ID:  (Hex)

Function Code:  (Hex)

Start Address (High):  (Hex)

Start Address (Low):  (Hex)

Bit Count (High):  (Hex)

Bit Count (Low):  (Hex)

Therefore, before using this configuration, you must know what is the Modbus Read Coil/Registers format that the Modbus slave devices supported.

▶ **Slave Node ID:**

Slave Node ID:  (Hex)

Set the slave Node ID which you want to access.

▶ **Function Code:**

Function Code:  (Hex)

In this setting interface, it supports the Modbus function code 0x01, 0x02, 0x03, and 0x04.

▶ **Start Address (High):**

Start Address (High):  (Hex)

This field indicates the high byte of Modbus reference IO data address.

▶ **Start Address (Low):**

Start Address (Low):  (Hex)

This field indicates the low byte of Modbus reference IO data address.

▶ **Bit Count(High):**

Bit Count (High):  (Hex)

This field indicates high byte of the number of bits which you want to read.

**Note:** When using function code 0x03 or 0x04, this field will be the number of words (high byte).



▶ **Bit Count(Low):**

Bit Count (High):  (Hex)

This field indicates low byte of the number of bits which you want to read.

**Note:** When using function code 0x03 or 0x04, this field will be the number of words (low byte).

◆ **Add:**



After setting the “Modbus Read Command, please click this button to add it into command list. Then, you can decide to add other command or save configuration into module. After you add a Modbus read command, the command will occupy a part of the “Read Memory Space”. This memory usage size will be based on the bit/word count setting of the “Modbus Read Command”.

◆ **Delete:**

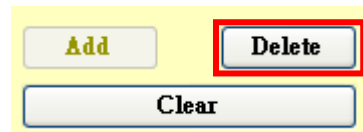

When you want to delete a “Modbus Read Command”, please click one of the “Modbus Read Command” from command list. Then the “Delete” button will be enabled. At this time, you can click “Delete” button to delete current “Modbus Read Command”. Afterward, the memory usage of “Read Memory Space” will be recalculated.

◆ **Clear:**

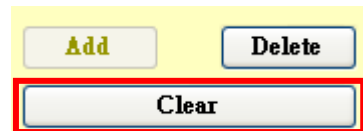

Click this button will clear all “Modbus Read Commands” in command list. Afterward, the usage of “Read Memory Space” will become to zero.

**Note:** After pressing the “Save Configuration” button to save configuration, the related parameters will be stored into the I-7530A-MR module. When I-7530A-MR is rebooted on operating mode, it will load these parameters and access the Modbus slave devices automatically and continuously.

### 6.3.1.2 Response CAN Message Configuration

**Response CAN Message Configuration**

Passively Response

CAN Response Interval:  (ms)

---

**CAN Configuration**

CAN Specification:  (Hex)

Mapping CAN ID:  (Hex)

IO Data Byte Count:  (Hex)

IO Memory Start Address:  (Hex)

CAN ID= 0x000, From 0x0000 to 0x0002

This function is used for configuring “Response CAN message” which you want to reply Modbus slave IO data via CAN bus. After setting, the CAN message with IO data will actively or passively be replied to CAN Bus by I-7530A-MR.

◆ **Passively Response:**

**Passively Response**

When you disable “Passively Response”, all the “Response CAN Messages” will be actively replied to the CAN Bus with fixed time interval. The fixed time can be set on “CAN Response Interval” field.

**Modbus Read Command (Actively)**

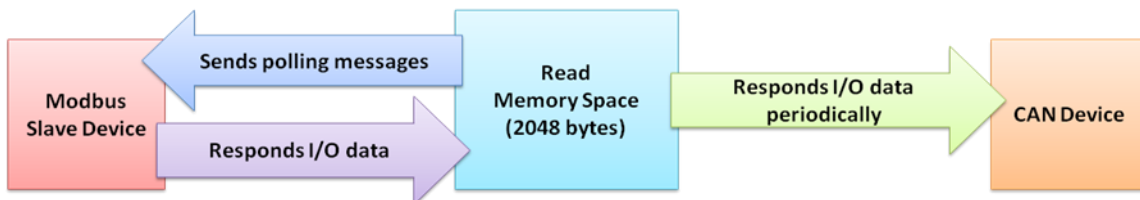

When the “Passively Response” is checked, the CAN message will be replied to the CAN Bus after receiving a RTR frame with the same CAN ID.

**For example:** If you want to use CAN ID 0x123 to reply 8 byte IO data. If the “Passively Response” is checked, the other CAN device needs to send a RTR frame with CAN ID 0x123 and then the I-7530A-MR will reply to a CAN message with IO data.

**Modbus Read Command (Passively)**

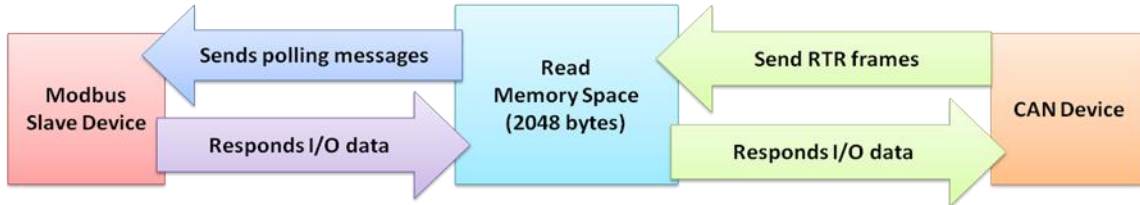

◆ **CAN Response Interval:**

CAN Response Interval:  (ms)

This field is used for setting response interval of CAN messages and its unit is millisecond. When not using “Passively Response” CAN message method, this function will be enabled.

◆ **CAN Configuration:**

**CAN Configuration**

CAN Specification:  (Hex)

Mapping CAN ID:  (Hex)

IO Data Byte Count:  (Hex)

IO Memory Start Address:  (Hex)

CAN ID= 0x000, Form 0x0000 to 0x0002

Configuration List

This field is used for setting a mapping relation which is between Modbus slave IO data read by “Modbus Read Commands” and a “Response CAN Message”.

▶ **CAN Specification:**

This field indicates this CAN message uses CAN 2.0A or CAN 2.0B. If the CAN 2.0A is selected, the maximum value of CAN ID is 0x7FF. Relatively, if the CAN 2.0B is selected, the maximum value of CAN ID is 0x1FFFFFFF.

▶ **Mapping CAN ID:**

This field indicates the hexadecimal value of the CAN ID.

▶ **IO Data Byte Count:**

This field indicates the data length of the CAN message.

The maximum value of byte count is 8 bytes due to the data length limitation of the CAN message.

▶ **IO Memory Start Address:**

This field indicates a start position of the “Read Memory Space”. By using “IO Data Byte Count” and this field, you can get a memory sector from the “Read Memory Space” which stores the I/O data accessed from the Modbus slave device via “Modbus Read Command”.

▶ **Add:**

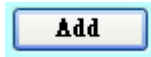

Click this button to add a configuration into “CAN Configuration List”. The configuration format includes value of CAN ID and memory range, please refer to the following screenshot.

The screenshot shows a 'CAN Configuration' form with the following fields: 'CAN Specification' (dropdown menu set to 'CAN 2.0A'), 'Mapping CAN ID' (text input '000' with '(Hex)' label), 'IO Data Byte Count' (text input '2' with '(Hex)' label), and 'IO Memory Start Address' (dropdown menu '0000' with '(Hex)' label). Below these fields, a summary line reads 'CAN ID= 0x000, From 0x0000 to 0x0002'. Red arrows point from two red-bordered boxes below to the '000' and '0x0000 to 0x0002' parts of this summary line.

Response CAN ID value

Memory Range

▶ **Delete:**



After selecting a command from the list, you can click this button to delete a CAN configuration.

▶ **Clear:**

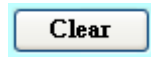

Clear all CAN Configuration from the “CAN Configuration List”.

## 6.3.2 Modbus Write Configuration

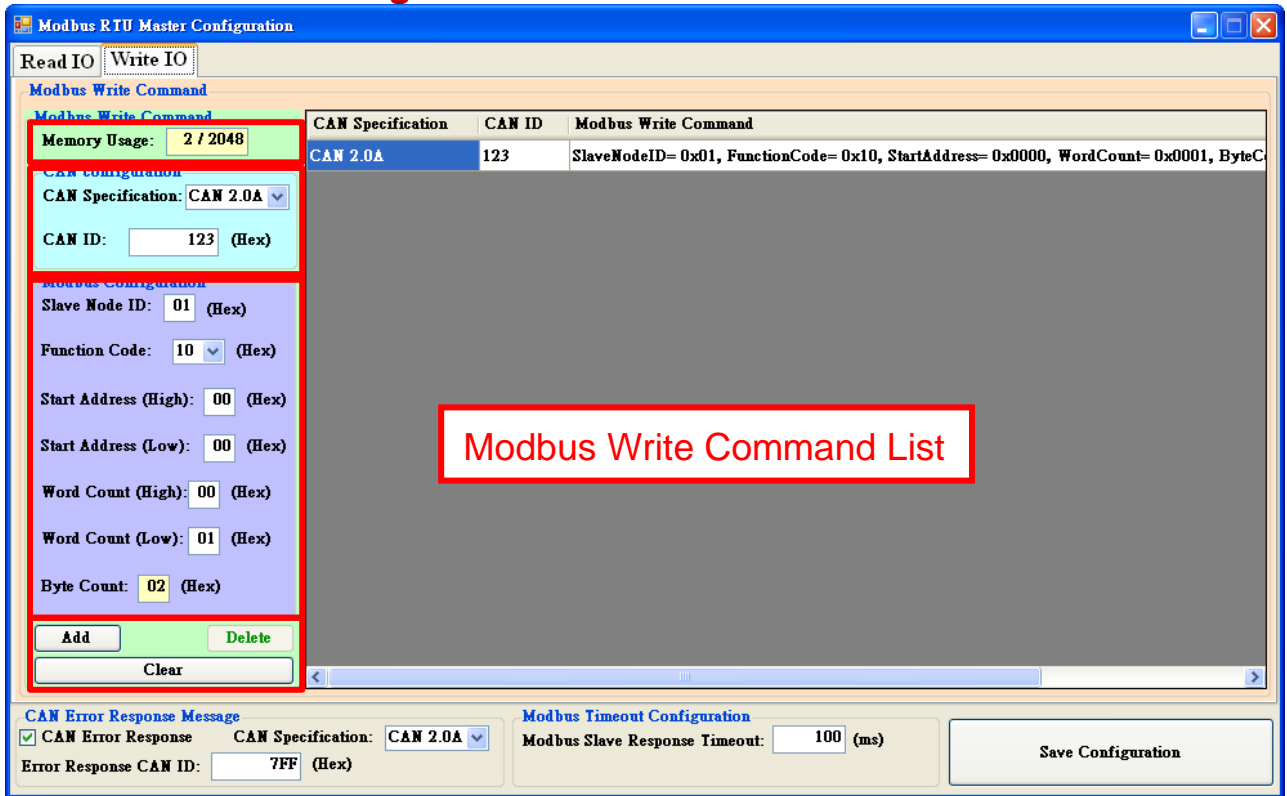

This page is used for configuring the “Modbus Write Command”. After setting done, the related parameters will be stored into the I-7530A-MR module. When I-7530A-MR is rebooted on operating mode, it will load these parameters and check received CAN messages for transmitting a “Modbus Write Command”.

### ◆ Memory Usage:

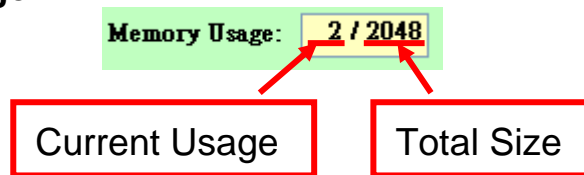

This field indicates the “Write Memory Space” usage. As section 6.2 description, the total memory size is 2048. The meaning of this field is “current usage / total size”, which unit is byte.

### ◆ CAN Configuration:

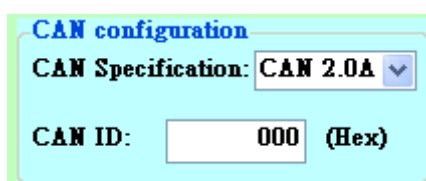

▶ **CAN Specification:**

This field indicates this CAN message uses CAN 2.0A or CAN 2.0B. If the CAN 2.0A is selected, the maximum value of CAN ID is 0x7FF. Relatively, if the CAN 2.0B is selected, the maximum value of CAN ID is 0x1FFFFFFF.

▶ **CAN ID:**

This field indicates the hexadecimal value of the CAN ID.

◆ **Modbus Configuration:**

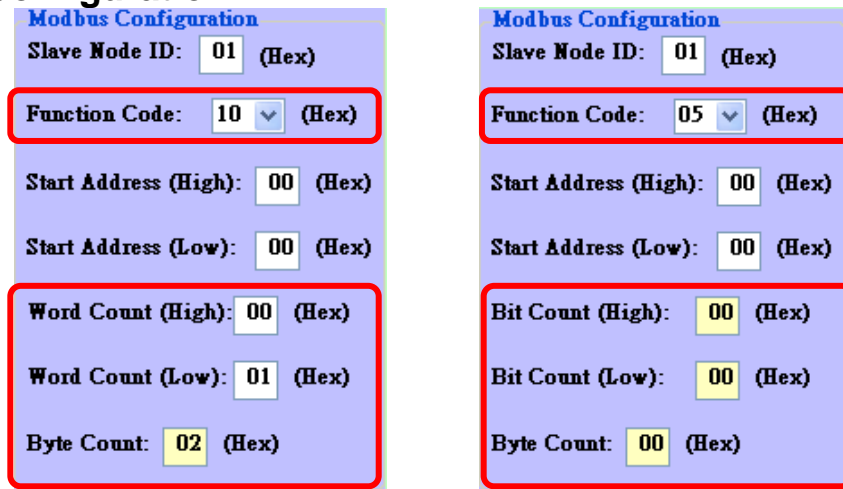

The “Modbus Configuration” is used for setting Modbus Write Coil /Registers commands. Before using this configuration, you must know what is the Modbus Write Coil/Registers format that the Modbus slave devices supported. After setting done, the I-7530A-MR will start to access the Modbus slave devices when receiving a CAN data frame with IO data.

Modbus write **signal** Coil/Registers format:

Node ID	Function Code	Start Address	Start Address	Bit/Word Count	Bit/Word Count	...	CRC	CRC
---------	---------------	---------------	---------------	----------------	----------------	-----	-----	-----

Modbus write **multiple** Coil/Registers format:

Node ID	Function Code	Start Address	Start Address	Bit/Word Count	Bit/Word Count	Byte Count	IO Data	...	CRC	CRC
---------	---------------	---------------	---------------	----------------	----------------	------------	---------	-----	-----	-----

▶ **Slave Node ID:**

Slave Node ID: 01 (Hex)

Set the Modbus slave ID which you want to access.

---

▶ **Function Code:**

Function Code: 05 (Hex)

In this setting interface, it supports the function code 0x05, 0x06, 0x0F, and 0x10.

▶ **Start Address (High):**

Start Address (High): 00 (Hex)

This field indicates the high byte of Modbus reference IO data address.

▶ **Start Address (Low):**

Start Address (Low): 00 (Hex)

This field indicates the low byte of Modbus reference IO data address.

▶ **Bit Count(High):**

Bit Count (High): 00 (Hex)

This field indicates the high byte of number of bits which you want to write. If the function code is 0x05 or 0x06, this field will be disabled.

**Note:** When using function code 0x10, this field will be the number of word (high byte).

▶ **Bit Count(Low):**

Bit Count (Low): 00 (Hex)

This field indicates the low byte of number of bits which you want to write. If the function code is 0x05 or 0x06, this field will be disabled.

**Note:** When using function code 0x10, this field will be the number of word (low byte).

▶ **Byte Count:**

Byte Count: 00 (Hex)

This field is always read-only. When using function code 0x0F or 0x10, the value of the field will automatically be calculated by utility



---

◆ **Add:**



Click this button to add a Modbus write command into “Write Command List”. The current configuration will be shown on the list. It includes CAN specification, value of CAN ID, and Modbus RTU Write command.

CAN Specification	CAN ID	Modbus Write Command
CAN 2.0A	123	SlaveNodeID= 0x01, FunctionCode= 0x10, StartAddress= 0x0000, WordCount= 0x0001, ByteCou

After you add a Modbus write command, the command will occupy a part of the “Write Memory Space”. This memory size will be based on the bit/word count of the “Modbus write command”.

◆ **Delete:**



When you want to delete a Modbus write command, please click one of the “Modbus Write Command” from “Write Command List” and then click the delete button. At this time, the current Modbus write command will be deleted. Afterward, the memory usage will be recalculated.

◆ **Clear**



Click this button will clear all Modbus write commands in “Write Command List”. Afterward, the “Write Memory Space” usage will be zero.

### 6.3.3 Common Configuration

#### ◆ CAN Error Response Message:

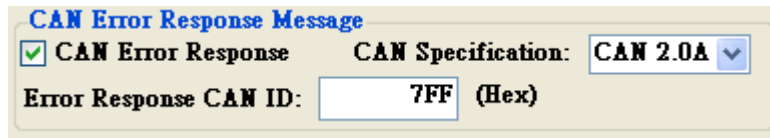

▶ **CAN Error Response:**

This function is used to transmit an error message via CAN bus when the Modbus communication error or command timeout is detected. When this function is checked, the “CAN Specification” field and “Error Response CAN ID” field will be enabled.

▶ **CAN Specification:**

This field indicates this CAN message uses CAN 2.0A or CAN 2.0B. If the CAN 2.0A is selected, the maximum value of CAN ID is 0x7FF. Relatively, if the CAN 2.0B is selected, the maximum value of CAN ID is 0x1FFFFFFF.

▶ **Error Response CAN ID:**

This field indicates the error message with this CAN ID will be transmitted when I-7530A-MR detects an error.

The CAN response message format is as following:

Error Response CAN Message Format:

CAN ID	Data Length	Data Byte0	Data Byte1~ Data Byte3	Data Byte4~ Data Byte6	Data Byte7
Error Response CAN ID	8	Identifier Code	Reserved	Modbus Exception	Reserved

➤ The “Identifier code” in Data Byte0 is divided into four types:

Identifier Code	Description
0x00	Reserved
0x01	It indicates the current Modbus command is transmitted completely and the I-7530A-MR receives the wrong Node id command
0x02	It indicates the current Modbus command is transmitted completely, but the I-7530A-MR does not receives any response command

0x03	It indicates the current Modbus command is transmitted completely, but the I-7530A-MR receives a “Modbus Exception” command.
------	--

- From Data Byte4 to Data Byte7, they indicate the “Modbus Exception” message. The “Modbus Exception” message includes Slave Node ID, Exception Function Code, and Exception Code. When the Identifier code is 0x03, this message is shown in the error response CAN message. Otherwise, these data value are 0x00.

■ Modbus Exception

Modbus Exception			
Byte4	Byte5	Byte6	Byte7
Slave Node ID	Exception Function Code	Exception Code	Reserved

■ Function Code and Exception Function Code relation

Function Code (Hex)	Exception Function Code (Hex)
0x01	0x81
0x02	0x82
0x03	0x83
0x04	0x84
0x05	0x85
0x06	0x86
0x0F	0x8F
0x10	0x90

■ Modbus Exception Code

About more Modbus exception code description, please refer to the Modbus protocol specification.

◆ Modbus Slave Response Timeout:

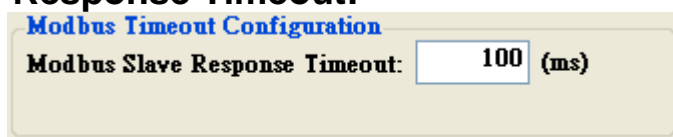

This field is used for setting Modbus command timeout value. When sending a Modbus command, the I-7530A-MR module will start to wait for a response command from the Modbus slave device until timeout

---

occurred. If there is no response, this Modbus command will be regarded as a timeout status. Afterward, the next Modbus command will be sent.

◆ **Save Configuration:**



This button is used to save “Modbus Read Configuration”, “Modbus Write Configuration”, and “Common Configuration” settings into the I-7530A-MR. After complete setup, please remember to click this button to save all configurations.

**Note:** After clicking the “Save Configuration” button to save all configurations, please remember to reboot the I-7530A-MR for reloading configuration.

---

## 7.Troubleshooting

### (1) Why the module's PWR LED flashes quickly:

If the I-7530A-MR CAN baud rate is not the same as the CAN baud rate of the CAN bus network, the PWR LED of the I-7530A-MR will flash one per 100ms because the I-7530A-MR cannot send any CAN message to the CAN bus network. Therefore, users need to read the I-7530A-MR status by using the command "S[CHK]<CR>"(in the section 4.5) to understand what is going on. In general, it may cause by the following errors: CAN media connection problem, terminal resistor problem, different baud rate configuration with CAN network and so forth.

### (2) How to set the user-defined CAN baud rate:

If users want to use the user-defined CAN baud rate for I-7530A-MR", choose the "**user-defined**" item and key-in the user-defined CAN baud rate value (for example: 83.333) in the Baud rate field of the Utility tool as the following figure.



Figure 6-1: User-defined CAN Baud Rate for I-7530A-MR

### (3) The rule of user-defined CAN baud rate setting in the SJA1000 CAN devices for communication compatible with I-7530A-MR:

If users use I-7530A-MR to communicate with SJA1000 CAN devices and CAN baud rate is user-defined CAN baud rate. Then in SJA1000 CAN

devices, users need to choose a set of proper CAN parameter (**BTR0** & **BTR1**) for communication compatible with I-7530A-MR and the rule is as follows:

- (1) The “**Samples**” value is 1.
- (1) The “**SJW**” value is as small as possible. (1 is the best).
- (2) The “**Tseg2**” value is as small as possible. (1 is the best)
- (3) The “**Tseg1**” value is as large as possible.

According to the above four rules, users can choose the proper BTR0 and BTR1. For example, if users want to use the CAN baud rate is 83.333 Kbps, according to the above rules, users should choose BTR0=05 and BTR1=1C for the CAN parameter of SJA1000 CAN devices like Figure 6-2.

BTR0(hex)	BTR1(hex)	Samples	Spl%	TSEG1	TSEG2	BRP	SJW	Max.Bus(m)	Kbps	Osc.Tol[%]
0F	12	1	66	3	2	16	1	516	83.3333	.2809
08	14	1	75	5	2	12	1	652	83.3333	.2101
07	18	1	83	9	2	8	1	788	83.3333	.1397
05	1C	1	87	13	2	6	1	856	83.3333	.1046
08	23	1	62	4	3	12	1	516	83.3333	.211
48	23	1	62	4	3	12	2	379	83.3333	.4219
07	27	1	75	8	3	8	1	697	83.3333	.1401
47	27	1	75	8	3	8	2	606	83.3333	.2801
05	2B	1	81	13	2	6	1	799	83.3333	.1049

Figure 6-2: User-defined CAN Baud Rate for SJA1000 Device