

9.1. IP66 Remote Temperature and Humidity Data Logger with LCD Display

NEW



DL-100T485
DL-100TM485

DL-100T485-W
DL-100TM485-W

DL-100T485/DL-100TM485 DL-100T485-W/DL-100TM485-W

IP66 Remote Temperature and Humidity Data Logger with LCD Display

Features

- Measurement Ranges: -20 ~ +60°C (-31 ~ +176°F) and 0 ~ 100% RH
- Accuracy: +/-0.4°C (±1.0°F) ; +/-3.0% RH
- LCD Display Shows Temperature, Humidity and Module ID
- 10 ~ 30 Vdc Power Input
- IP66 Waterproof
- Data Logger Can Store Up to 4088 Temperature and Humidity Records
- RS-485 Communication interface
- DCON or Modbus RTU Protocol
- Windows Software Included



Introduction

The DL-100T485/DL-100T485-W/DL-100TM485/DL-100TM485-W is a temperature and humidity data logger module. It contains an RS-485 communication interface and an LCD display to show a variety of temperature, humidity and module ID data. The data storage memory can store up to 4088 temperature and humidity records.

The Data Logger Utility is included to allow installation, configuration, retrieval and display of data in a powerful chart format that can be exported to Excel.

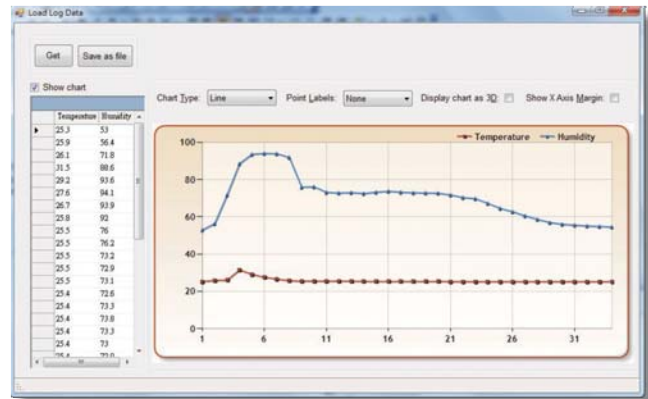

Applications

- Transportation of food or pharmaceuticals
- Food and beverage industry (HACCP)
- Blood stations, pharmacies
- Building and energy management
- Warehouses
- Museums, archives, galleries

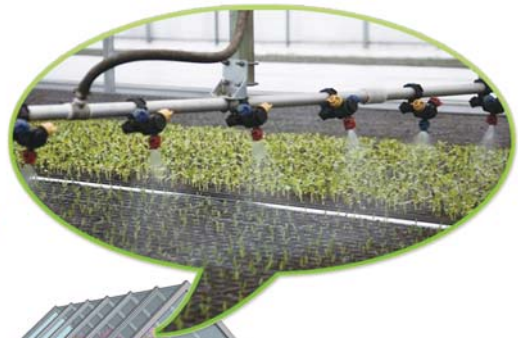

Greenhouse Automation



Specifications

Models	DL-100T485	DL-100T485-W	DL-100TM485	DL-100TM485-W
Temperature Sensor				
Measuring Range	-20 ~ +60°C (-31 ~ +176°F)			
Resolution	0.1°C			
Accuracy	Typical: +/-0.4°C; refer to figure 1 for details			
Precision	+/- 0.1°C			
Humidity Sensor				
Measuring Range	0 ~ 100% RH			
Resolution	0.1% RH			
Accuracy	Typical: ±3% RH @ 20 ~ 80% RH; refer to figure 2 for details			
Precision	+/- 0.1% RH			
LCD Display				
Displayed Information	Temperature (°C and °F), Humidity (RH), Module ID			
Data Logger				
Time Interval	10 seconds to 1 day			
Max. Records	4088 temperature and humidity records			
Mode	Overwrite or stop logging when storage space is full			
Overwrite Limitation	1,000,000 cycles			
Communication				
Interface	RS-485; non-isolated			
Baudrate	1200 ~ 115200 bps			
Data format	N,8,1			
Protocol	DCON		Modbus RTU	
Max. Modules on same bus	32			
Power				
Input Range	+10 ~ 30 Vdc			
Power Consumption	0.15 W			
Mechanical				
Dimensions (W x L x H)	82 mm x 126 mm x 55 mm			
Waterproof Level	IP66			
Installation	DIN-Rail; Wall mount			
Environment				
Operating Temperature	-20 ~ +60°C			
Storage Temperature	-30 ~ +80°C			
Ambient Relative Humidity	5 ~ 95% RH, Non-condensing			

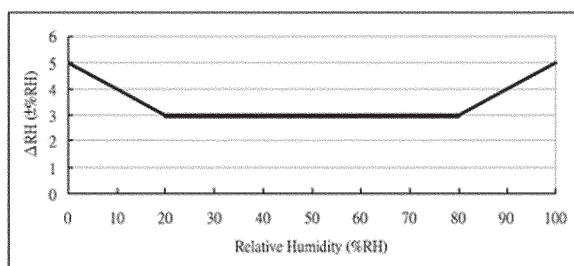

Figure 1: Maximum RH-tolerance at 25°C per sensor.

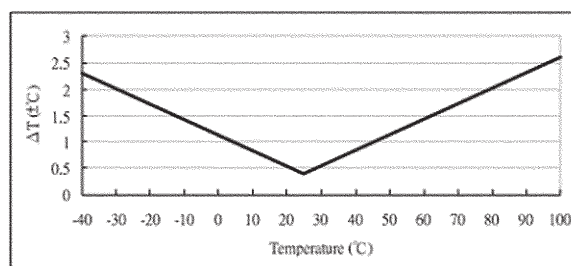
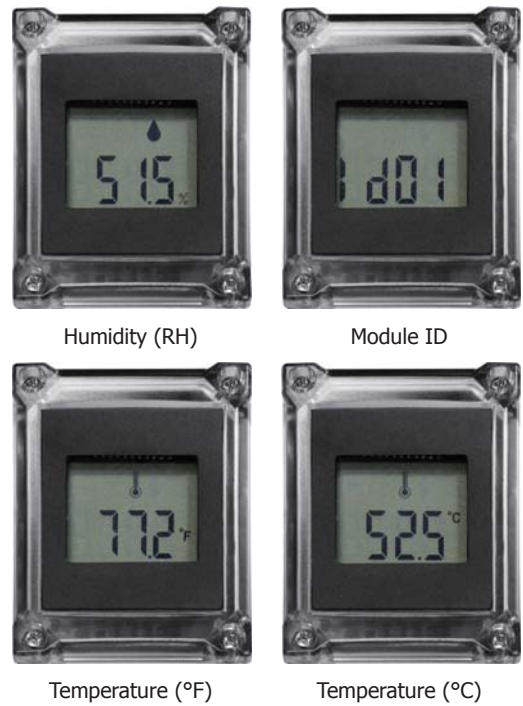
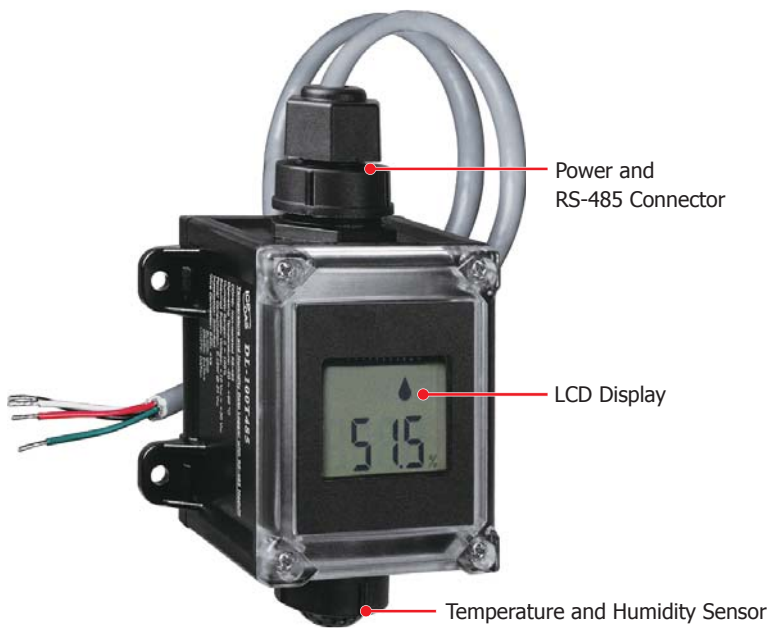

Figure 2: Maximum T-tolerance per sensor.

Installation



Appearance



Dimensions (Units: mm)

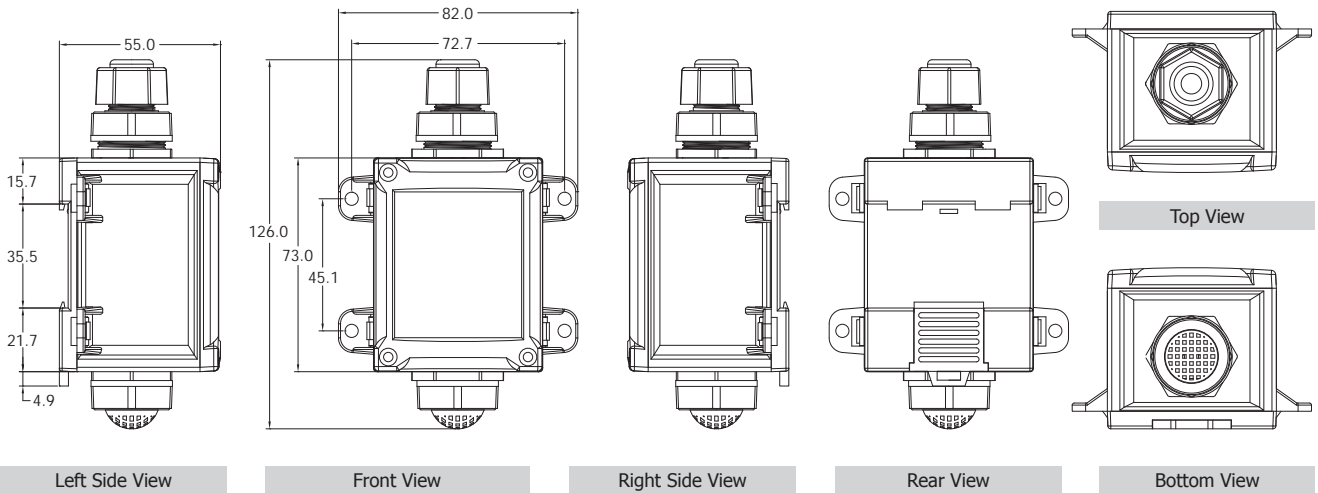

Ordering Information

DL-100T485 CR	DCON Protocol Based IP66 RS-485 Remote Temperature and Humidity Data Logger with LCD Display (Black Cover) (RoHS)
DL-100T485-W CR	DCON Protocol Based IP66 RS-485 Remote Temperature and Humidity Data Logger with LCD Display (White Cover) (RoHS)
DL-100TM485 CR	Modbus RTU Protocol Based IP66 RS-485 Remote Temperature and Humidity Data Logger with LCD Display (Black Cover) (RoHS)
DL-100TM485-W CR	Modbus RTU Protocol Based IP66 RS-485 Remote Temperature and Humidity Data Logger with LCD Display (White Cover) (RoHS)

Optional Accessories

tM-7561 CR	Isolated USB to RS-485 Converter (RoHS)
tM-7520U CR	Isolated RS-232 to RS-485 Converter (RoHS)
MDR-20-24 CR	24V/1A, 24 W Power Supply with DIN-Rail Mounting (RoHS)