

AN5633K

SECAM-PAL Signal Conversion Circuit

■ Description

The AN5633K is an integrated circuit designed for conversion from SECAM Colour TV Signal to Pseudo PAL modulated in line sequential orthogonal two-phase width. Suitable combination with AN5601K.

■ Features

- Reduction of line crawling by line sequential detection (12dB as compared with the conventional one)
- SECAM/PAL discriminating capability is improved by detecting colour killer voltage of PAL demodulation IC
- Reduced number of peripheral units like transformer and adjustment processes

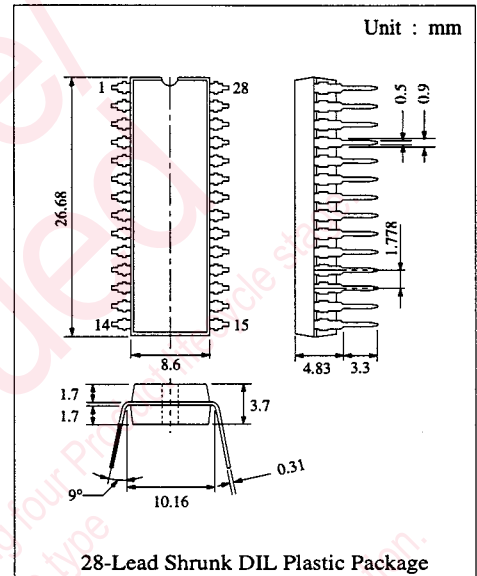

■ Block Diagram

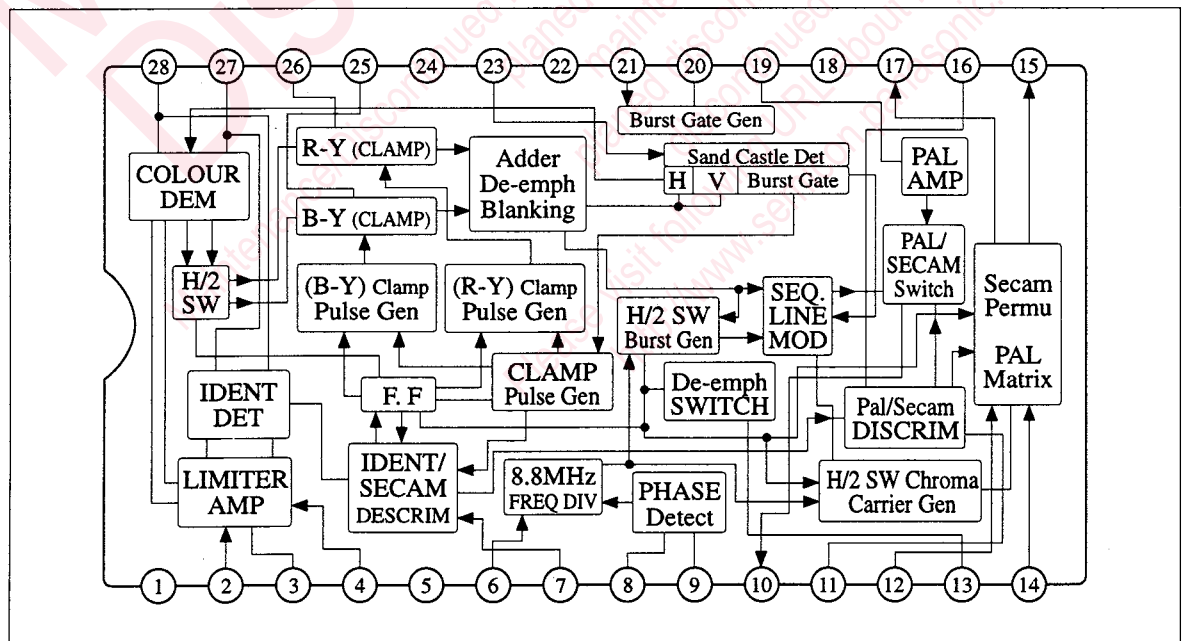

■ Absolute Maximum Ratings (Ta=25°C)

Item		Symbol	Rating		Unit
Supply Voltage		V _{CC}	14.4		V
Supply Current		I _{CC}	82.7		mA
Voltage		V _{2, 4, 11, 13, 16, 22, 23}	0	V ₁₈₋₁	V
		V ₅	0	6	V
		V ₆	0	8	V
		V _{12, 14, 19}	0	7	V
Current		I ₈	-1	0	mA
		I ₉	-3	0	mA
		I ₁₃	0	10	mA
		I _{20, 21}	-0.05	2	mA
Power Dissipation		P _D	1142		mW
Temperature	Operating Ambient Temperature	T _{opr}	-20 ~ +70		°C
	Storage Temperature	T _{stg}	-55 ~ +150		°C

■ Recommended Operating Range (Ta=25°C)

Item	Symbol	Range
Operating Supply Voltage Range	V _{CC}	9.6V ~ 14.4V

■ Electrical Characteristics (Ta=25°C)

Item	Symbol	Condition	min.	typ.	max.	Unit
DC Section						
Circuit Current 12V	I _{CC1}	V _{CC1} = 12V, V _{CC2} = 5V	37	50	63	mA
Circuit Current 5V	I _{CC2}	V _{CC1} = 12V, V _{CC2} = 5V	10	13	16	mA
AC Section						
Chroma Section						
SECAM Input Signal Limiting	V _{O(lim)}	4.433168MHz Input of Pin 4, 10 ~ 300mVpp Output of Pin 28	-1	0	1	dB
Limiter Amp. Gain	G _{V(lim)}	Ratio of 4.433168MHz Input of Pin 4 to 1mVpp output of Pin 28	28	32	36	dB
SECAM Demodulator Colour Diifference Ratio (B-Y/R-Y)	B-Y/R-Y	SECAM Colour Bar input of Pin 4 : 200mVpp, Ratio of B of DB to R of DR of Pin 24 when the white levels of DB and DR of Pin 24 are matched	0.67	0.74	0.81	Times
SECAM Output Signal Voltage	e _{O(SECAM)}	SECAM Colour Bar input of Pin 4 : 200mVpp R of Output DR of Pin 24 when the white levels of DB and DR of Pin 24 are matched	60	180	300	mVpp
Ratio of Burst to Chroma	$\frac{e_{O(SECAM)}}{e_{O(Burst)}}$	SECAM Colour Bar input of Pin 4 : 200mVpp Ratio of burst to R of output DR of Pin 24 when the white levels of DB and DR of Pin 24 are matched	1.8	2.6	3.4	Times
PAL Input Signal Voltage	V _{i(PAL)}	PAL input signal of Pin 19			1100	mVpp
PAL Output Signal Voltage	e _{O(PAL)}	PAL input of Pin 19 : 750mVpp, Output of Pin 10	490	620	750	mVpp
Discrimination Section						
Killer Tolerance	e _k	Killer On level to SECAM Colour Bar input of Pin 4 : 0dB (100mVpp)	-38	-31	-24	dB
Killer Detection Voltage SECAM Colour	V _{11-1(SECAM)}	Voltage of Pin 11 when SECAM Colour Bar input of Pin 4 is -7dB	0	0.25	0.5	V
Killer Detection Voltage SECAM OFF	V _{11-1(OFF)}	Voltage of Pin 11 when SECAM Colour Bar input of Pin 4 is -43dB	0.5	1.3	2.1	V



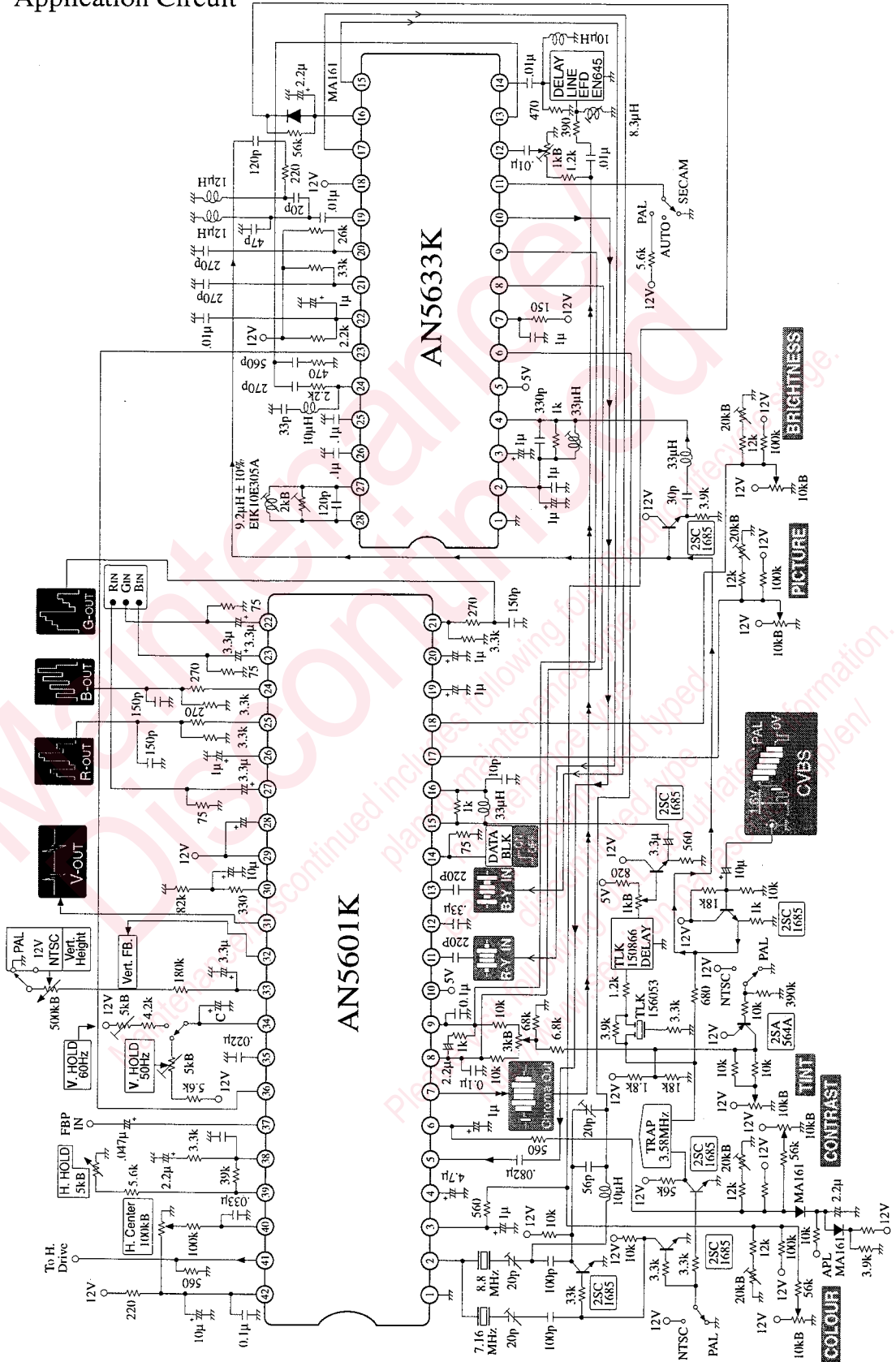

■ Electrical Characteristics (Ta=25°C) (Continue)

Item	Symbol	Condition	min.	typ.	max.	Unit
Discrimination Section (Continue)						
Ident Detection Voltage PAL	V _{11-1 PAL}	Voltage of Pin11 when PAL Colour Bar input burst of Pin 4 is 150mVpp	0.5	1.3	2.1	V
Pulse Input						
BLK Detection Voltage	V _{BLK}	Blanking pulse input voltage range of Pin 23	1	1.5	2	V
H Pulse Detection Voltage	V _H	H pulse input voltage range of Pin 23	3	3.5	4	V
Burst Gate Pulse Det. Voltage	V _{BGP}	Burst gate pulse input voltage range of Pin 23	6.5	7	7.5	V
Burst Phase Width Adjustment Section						
Comparator Threshold Level	V _{21LH}	Voltage of Pin 20 at which L is changed to H when 3kΩ Vcc of Pin 20 and 100μA of Pin 21 are applied	2.6	3.1	3.6	V
SECAM Switch PAL Matrix						
PAL Amplification	A _{PAL}	Gain of Pin 12 to Pin 15 input in case of SECAM	0.9	1.1	1.3	Times
PAL Amplification Error	ΔA _{PAL}	Error between gain of Pin 12 input to Pin 15 and gain of Pin 14 input to Pin 15 output	0	5	10	%
SECAM Amplification	A _{SECAM}	Gain of Pin 12 to Pin 15 output in case of PAL	1.8	2.2	2.6	Times
De-emphasis Switch						
De-emphasis Switch Output DR	V _{13-1 DR}	Pin 13 output is Vcc1=12V when SECAM Colour Bar DR of Pin 4 is input	11	12	13	V
De-emphasis Switch Output DB	V _{13-1 DB}	Pin 13 output is Vcc1=12V when SECAM Colour Bar DB of Pin 4 is input	0	0.25	0.5	V

Application Circuit

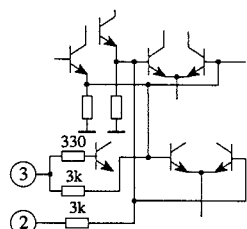
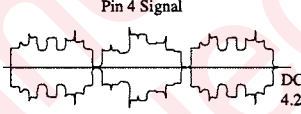
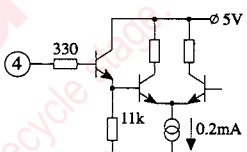

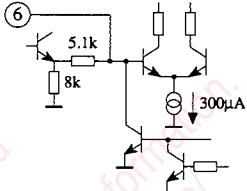
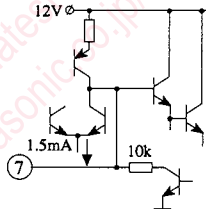
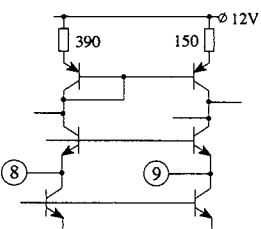
Pin Descriptions

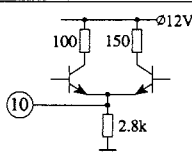
Pin No.	Pin Name	Pin Description	Typical Waveform	Equivalent Circuit
1	GND	GND Pin		
2	Limiter Feedback	Filter Pin for keeping DC balance of limiter circuit		
3				
4	SECAM Signal Input	SECAM Input pin PAL Signal after input is separated at the latter Ident section and the switch selection according to PAL is made	<p>Pin 4 Signal</p>  <p>DC 4.2V</p> <p>Amplitude almost becomes flat after fed through the Bell-filter</p>	
5	Power Supply (5V)	5V Power Pin		
6	8.8MHz CW Input	Input 8.8MHz of the AN5601K		
7	System Discrimination Hold Capacitance	Filter pin for holding the result discriminated by the system at the Ident section		
8	Phase Detection	Pin for inputting the result of chroma carrier phase of Pseudo PAL signal discriminated by the AN5601K Proper phase is given by the entire system		
9				
10	Output (PAL/Pseudo PAL)	Pin for output signal which was converted into the Pseudo PAL signal of SECAM	<p>Pin 10 Signal</p>  <p>DC 8.5V</p> <p>(Pseudo PAL)</p>	

■ Pin Descriptions (Continue)

Pin No.	Pin Name	Pin Description	Typical Waveform	Equivalent Circuit
11	System Discriminating Switch	Output pin for determining that the signal input to Pin 4 is PAL or SECAM. It also has the function to switch the internal system manually		
12	Direct Signal Input	Pin for signal which is directly input to the PAL matrix in case of PAL and to the permutator circuit in case of SECAM. Connect to the ACC output pin of the AN5601K		
13	De-emphasis Switch	Pin for switching the filter for de-emphasizing Pin 24		
14	Delay Signal Input	Pin for 1-H delayed signal which is input to the PAL matrix in case of PAL and to the permutator circuit in case of SECAM		
15	R-Y Signal Output	Continuous modulation R-Y signal output pin		
17	B-Y Signal Output	Continuous modulation B-Y signal output pin		
16	PAL Colour Killer Discrimination Input	Pin for inputting colour killer discriminating voltage of the AN5601K. The PAL/SECAM discriminating capability is increased by the internal logic circuit		

■ Pin Descriptions (Continue)

Pin No.	Pin Name	Pin Description	Typical Waveform	Equivalent Circuit
18	Power Supply (12V)	12V Power Pin		
19	PAL Signal Input	Signal together with Pin 4 input, is output directly from Pin 19 to Pin 10 in case of PAL	<p>Pin 19 Signal DC 4.2V</p>	
20	Burst Gate Pulse Fall Setting	Pin for setting the falling point of internal burst sampling pulse		
21	Burst Gate Pulse Rise Setting	Pin for setting the rising point of internal burst sampling pulse		
22	Reference Bias Voltage	Filter pin for applying noise-free reference voltage to the internal circuit		<p>External of IC</p>
23	Pulse Signal Input	Pin for taking in Sand castle pulse of the AN5601K		
24	De-emphasis	Pin for de-emphasizing a signal to which SECAM signal is demodulated in line-sequence	<p>Pin 24 Signal</p>	
25	B-Y Clamping Capacitance	Clamping Capacitor pin for regenerating DC voltage in B-Y for Pin 25, R-Y for Pin 26 line in which SECAM signal is demodulated in line-sequence		
26	R-Y Clamping Capacitance			
27	Discriminator	Discriminator Pin for SECAM demodulation R.L.C. parallel resonator is externally connected		
28				

- Supplementary Explanation
- Characteristic Curve Diagrams

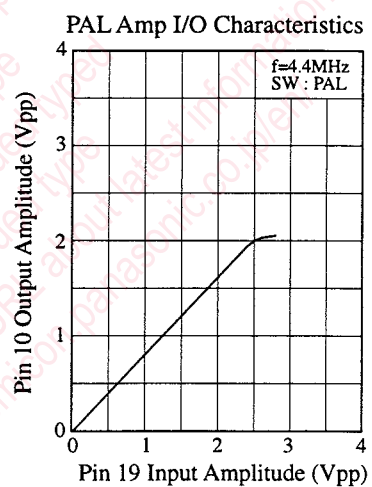
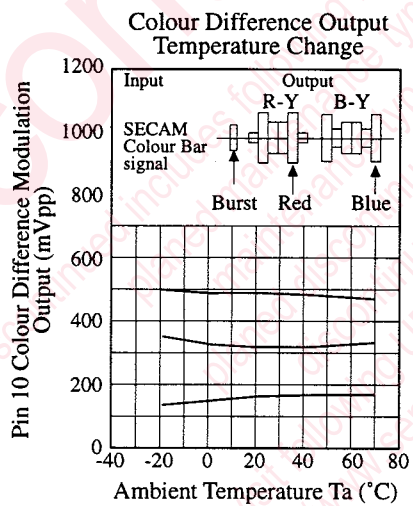
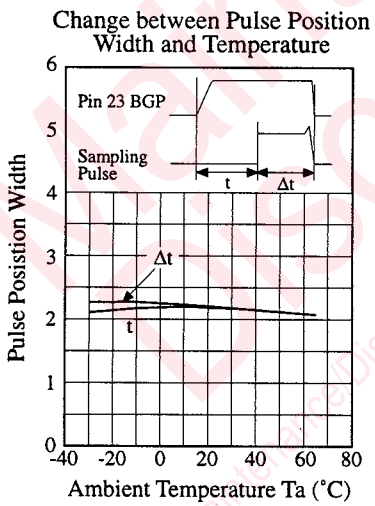
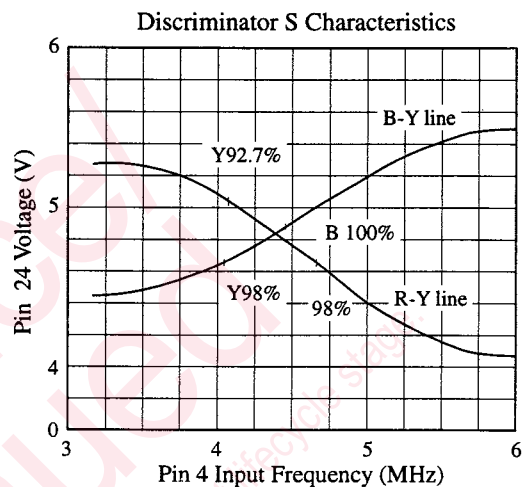
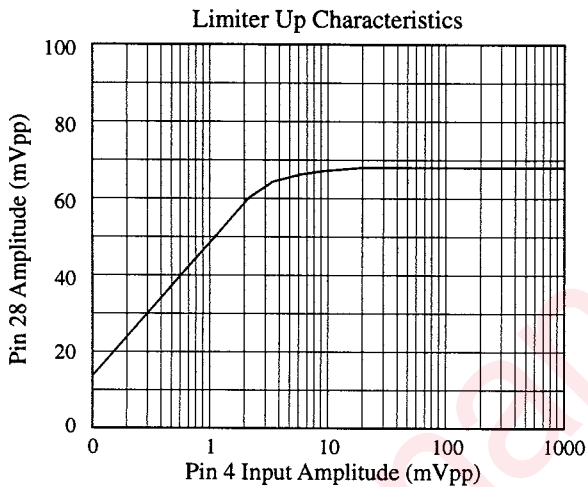

■ Adjustment Procedure of AN5633K

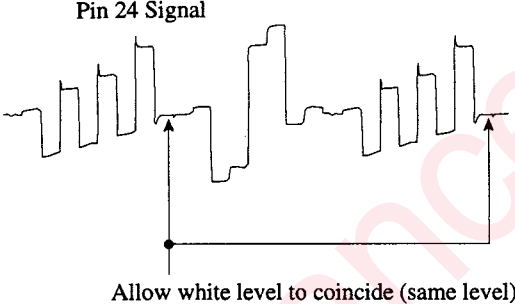
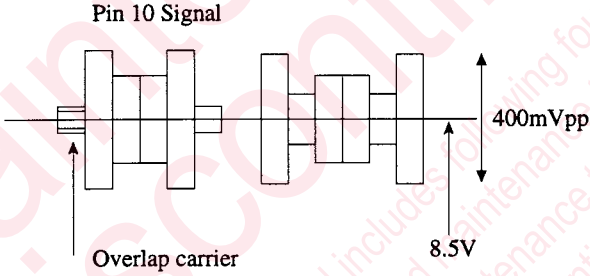
S/NO	Item	Adjustment Procedure												
1a	Sets Pins 11 and 16 to 0V and input SECAM Colour Bar at SECAM Mode.  <p style="text-align: center;">Pin 24 Signal</p> <p style="text-align: center;">Allow white level to coincide (same level)</p> <p style="text-align: center;">FIG. A</p>	Adjust the discriminating transformer between Pin 28 and 27 and allow white (black) level DC to coincide. (See FIG. A)												
1b	 <p style="text-align: center;">Pin 10 Signal</p> <p style="text-align: center;">Overlap carrier</p> <p style="text-align: center;">8.5V</p> <p style="text-align: center;">400mVpp</p> <p style="text-align: center;">FIG. B</p>	Adjust the 2k Ω variable resistor between Pin 28 and Pin 27 and overlap the white level carrier (See FIG. B). Adjust the 20pF variable capacitor at Pin 6 so that the amplitude of Pin 7 of AN5601K becomes minimum.												
Return Pins 11 and 16 to the AUTO Mode														
<table border="1" style="width: 100%; border-collapse: collapse;"> <tbody> <tr> <td rowspan="2" style="text-align: center;">Pin 11 in AUTO</td> <td style="text-align: center;">SECAM Colour</td> <td style="text-align: center;">0V</td> <td rowspan="2" style="text-align: center;">Automatically given in the AN5633K</td> </tr> <tr> <td style="text-align: center;">Other</td> <td style="text-align: center;">~ 1V</td> </tr> <tr> <td rowspan="2" style="text-align: center;">Pin 16 in AUTO</td> <td style="text-align: center;">PAL Colour</td> <td style="text-align: center;">1.5V or more</td> <td rowspan="2" style="text-align: center;">Given from the AN5601K</td> </tr> <tr> <td style="text-align: center;">PAL Killer</td> <td style="text-align: center;">0V</td> </tr> </tbody> </table>			Pin 11 in AUTO	SECAM Colour	0V	Automatically given in the AN5633K	Other	~ 1V	Pin 16 in AUTO	PAL Colour	1.5V or more	Given from the AN5601K	PAL Killer	0V
Pin 11 in AUTO	SECAM Colour	0V		Automatically given in the AN5633K										
	Other	~ 1V												
Pin 16 in AUTO	PAL Colour	1.5V or more	Given from the AN5601K											
	PAL Killer	0V												

Request for your special attention and precautions in using the technical information and semiconductors described in this book

- (1) If any of the products or technical information described in this book is to be exported or provided to non-residents, the laws and regulations of the exporting country, especially, those with regard to security export control, must be observed.
- (2) The technical information described in this book is intended only to show the main characteristics and application circuit examples of the products. No license is granted in and to any intellectual property right or other right owned by Panasonic Corporation or any other company. Therefore, no responsibility is assumed by our company as to the infringement upon any such right owned by any other company which may arise as a result of the use of technical information described in this book.
- (3) The products described in this book are intended to be used for standard applications or general electronic equipment (such as office equipment, communications equipment, measuring instruments and household appliances).
Consult our sales staff in advance for information on the following applications:
 - Special applications (such as for airplanes, aerospace, automobiles, traffic control equipment, combustion equipment, life support systems and safety devices) in which exceptional quality and reliability are required, or if the failure or malfunction of the products may directly jeopardize life or harm the human body.
 - Any applications other than the standard applications intended.
- (4) The products and product specifications described in this book are subject to change without notice for modification and/or improvement. At the final stage of your design, purchasing, or use of the products, therefore, ask for the most up-to-date Product Standards in advance to make sure that the latest specifications satisfy your requirements.
- (5) When designing your equipment, comply with the range of absolute maximum rating and the guaranteed operating conditions (operating power supply voltage and operating environment etc.). Especially, please be careful not to exceed the range of absolute maximum rating on the transient state, such as power-on, power-off and mode-switching. Otherwise, we will not be liable for any defect which may arise later in your equipment.
 - Even when the products are used within the guaranteed values, take into the consideration of incidence of break down and failure mode, possible to occur to semiconductor products. Measures on the systems such as redundant design, arresting the spread of fire or preventing glitch are recommended in order to prevent physical injury, fire, social damages, for example, by using the products.
- (6) Comply with the instructions for use in order to prevent breakdown and characteristics change due to external factors (ESD, EOS, thermal stress and mechanical stress) at the time of handling, mounting or at customer's process. When using products for which damp-proof packing is required, satisfy the conditions, such as shelf life and the elapsed time since first opening the packages.
- (7) This book may be not reprinted or reproduced whether wholly or partially, without the prior written permission of our company.