

Silicon NPN Power Transistors

2SC3507

DESCRIPTION

- With TO-3PFa package
- High-speed switching
- High collector-base voltage V_{CBO}
- Satisfactory linearity of forward current transfer ratio h_{FE}

APPLICATIONS

- For high-speed switching applications

PINNING

PIN	DESCRIPTION
1	Base
2	Collector
3	Emitter

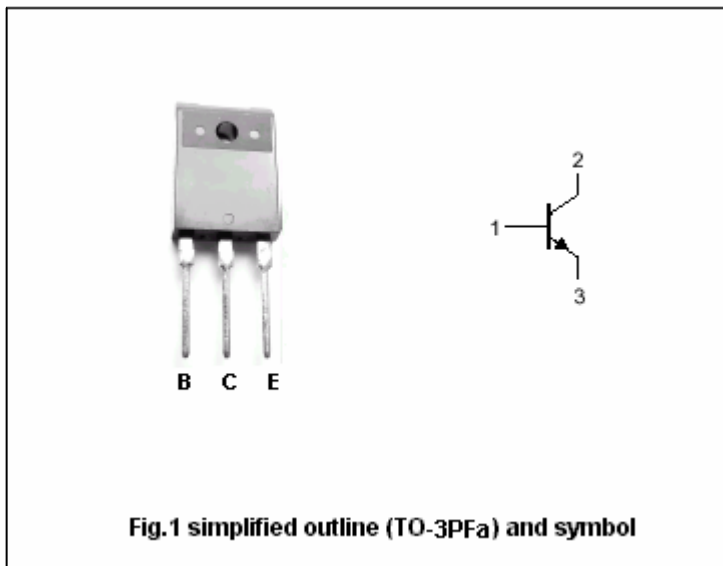

Absolute maximum ratings($T_a=25^\circ C$)

SYMBOL	PARAMETER	CONDITIONS	VALUE	UNIT
V_{CBO}	Collector-base voltage	Open emitter	1000	V
V_{CEO}	Collector-emitter voltage	Open base	800	V
V_{EBO}	Emitter-base voltage	Open collector	7	V
I_C	Collector current		5	A
I_{CM}	Collector current-peak		10	A
I_B	Base current		3	A
P_C	Collector power dissipation	$T_C=25^\circ C$	80	W
		$T_a=25^\circ C$	3	
T_j	Junction temperature		150	$^\circ C$
T_{stg}	Storage temperature		-55~150	$^\circ C$

Silicon NPN Power Transistors

2SC3507

CHARACTERISTICS

T_j=25 °C unless otherwise specified

SYMBOL	PARAMETER	CONDITIONS	MIN	TYP.	MAX	UNIT
V _{CEO(SUS)}	Collector-emitter sustaining voltage	I _C =0.5A ; L=50mH	800			V
V _{CEsat}	Collector-emitter saturation voltage	I _C =3A ; I _B =0.6A			1.5	V
V _{BEsat}	Base-emitter saturation voltage	I _C =3A ; I _B =0.6A			1.5	V
I _{CBO}	Collector cut-off current	V _{CB} =1000V; I _E =0			50	μA
I _{EBO}	Emitter cut-off current	V _{EB} =7V; I _C =0			50	μA
h _{FE}	DC current gain	I _C =3A ; V _{CE} =5V	6			
f _T	Transition frequency	I _C =0.5A ; V _{CE} =5V; f=1MHz		6		MHz

Switching times

t _{on}	Turn-on time	I _C =3A; V _{CC} =250V I _{B1} =0.6A, I _{B2} =-1.2A			1.0	μs
t _s	Storage time				2.5	μs
t _f	Fall time				0.5	μs

Silicon NPN Power Transistors

2SC3507

PACKAGE OUTLINE

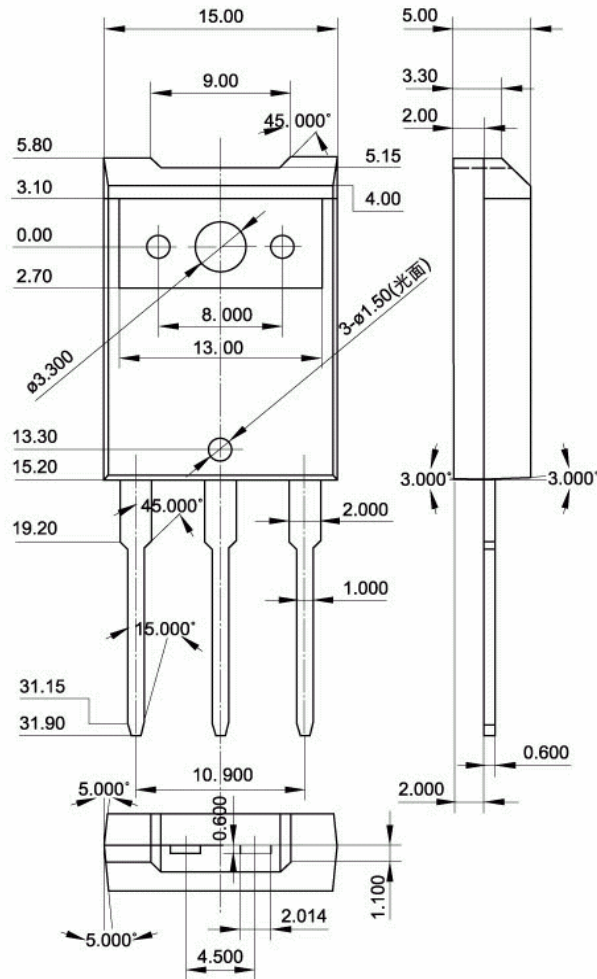

Fig.2 Outline dimensions (unindicated tolerance:±0.30mm)

Silicon NPN Power Transistors

2SC3507

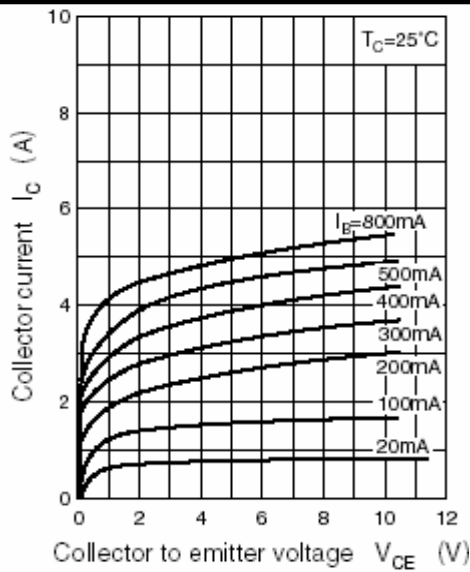

Fig.3 Static Characteristic

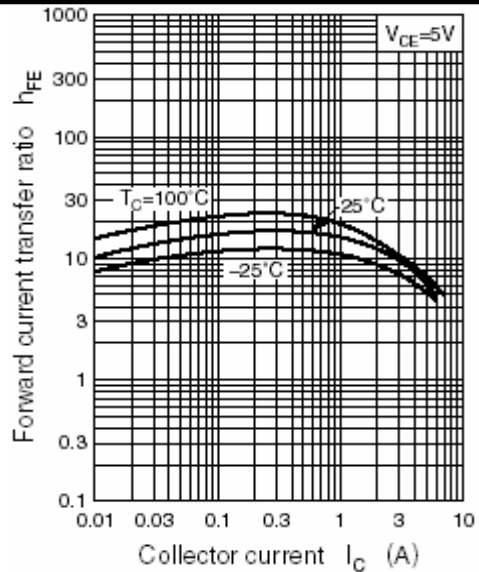

Fig.4 DC current Gain

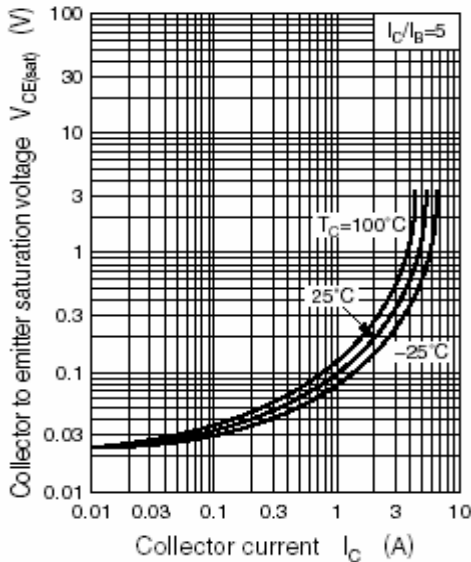

Fig.5 Collector-Emitter Saturation Voltage

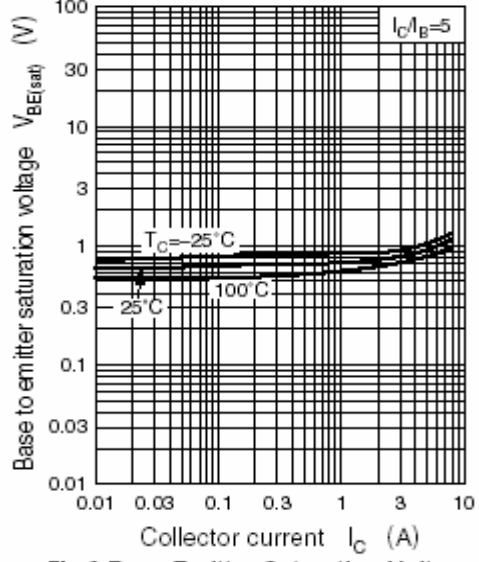

Fig.6 Base-Emitter Saturation Voltage

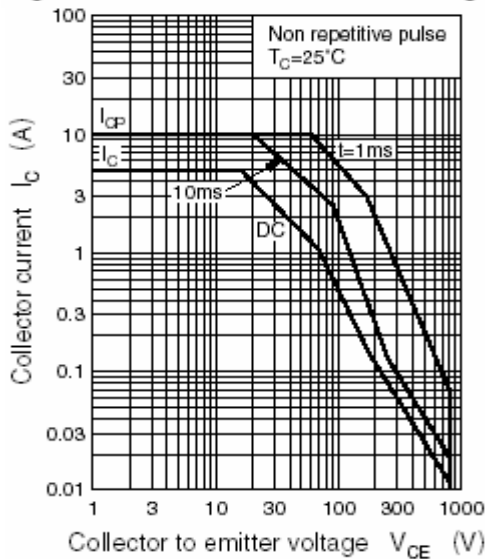

Fig.7 Safe Operating Area