

LEDex R110

Red(660nm/730nm) Bar

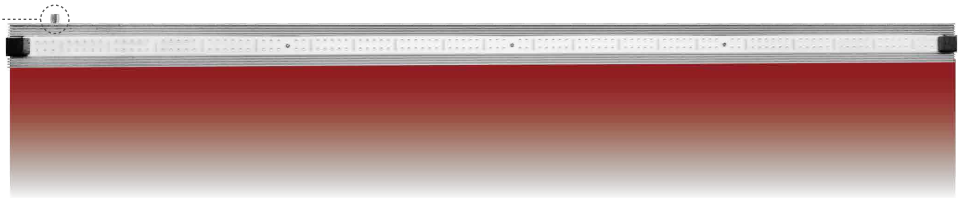
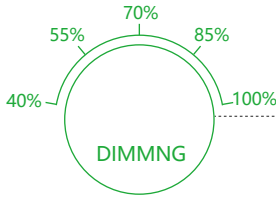

Specifications

Technology Items	Parameters				
Product Code	80.01.0219				
Model Code	R110				
Light Source	Commercial Horticulture				
Spectrum	Red Spectrum				
Input Voltage	AC100V~305V				
Bar Power	110Watt (Single)				
Fixture Power Output Range	110~880Watt, DIY Combination				
Dimming	Manual: 40%, 55%, 70%, 85%, 100%; NCCS 0-10V: 20%~100%				
Efficiency	2.45~2.50μmol/J				
Bar Dimensions/Weight	45.8"x2.0"x1.7"/3.9Lbs(116x5x4cm/1.8kg)				
Track Dimensions/Weight	47.4"x3.1"x1.7"/3.3Lbs(120x8x4cm/1.5kg)				
Mounting Height	≥6"(152mm)				
Light Distribution	120°				
Lifetime	≥50,000hrs				
Driver	110 Watt Self Contained Driver				
Shell Color	Silver/Dark Gray				
Certifications	ETL, CE				
Waterproof	IP54				
Warranty	3 Years				
Packing	6PCS/Carton, Bar & Track Separate Packing				
Number of Containers	20GP: 1500 Carton 40GP: 3300 Carton 40HQ: 4000 Carton				
Fixtures Output Power	440Watt	550Watt	660Watt	770Watt	880Watt
Quantity of Bar	4pcs	5pcs	6pcs	7pcs	8pcs
PPF	1080μmol/s	1350μmol/s	1620μmol/s	1890μmol/s	2160μmol/s
Weight	9.2kg	11kg	12.8kg	14.6kg	16.4kg
Input Amperage@120V	4.32A	5.40A	6.49A	7.57A	8.65A
Input Amperage@208V	2.25A	2.81A	3.37A	3.93A	4.50A
Input Amperage@240V	1.97A	2.47A	2.96A	3.45A	3.95A
Input Amperage@277V	1.74A	2.18A	2.61A	3.05A	3.48A
SINGLE LIGHT BAR SPECIFIC (MAXIMUM AMPERAGE BY VOLTAGE SERVICE)					
VOLTAGE	120V	208V	240V	277V	
AMPERAGE	1.14A	0.62A	0.57A	0.49A	

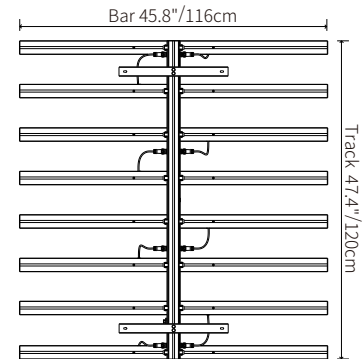

*Product Size

Fixture

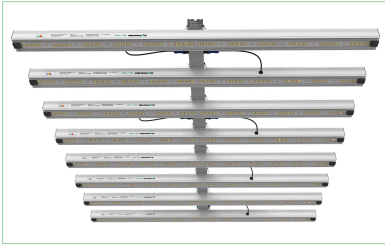

Picture 1

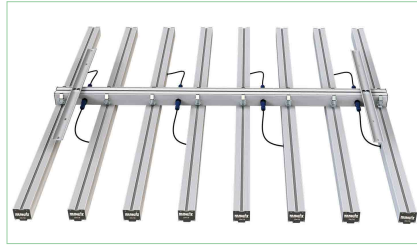

Picture 2



Picture 3

Spectrum (Red)

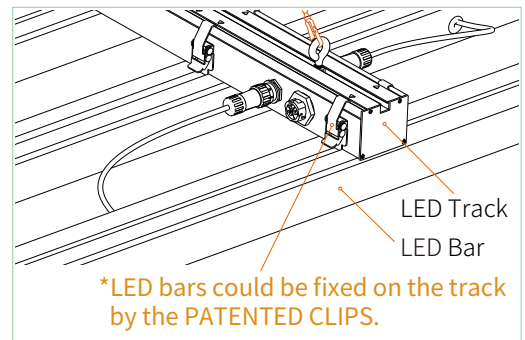
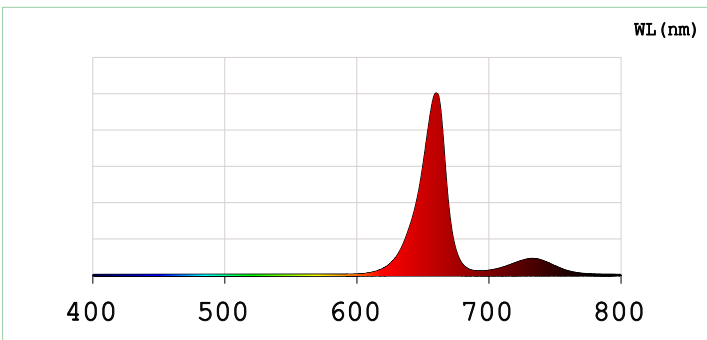

DIY Combination

4-8 light bars can be used on each 48" track allowing the end user to apply the desired light umol density onto the plant canopy.

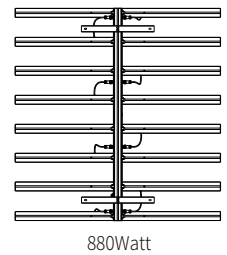
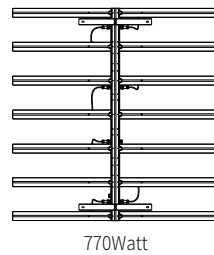
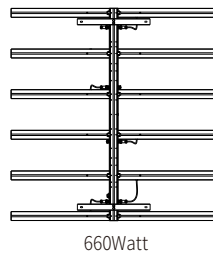
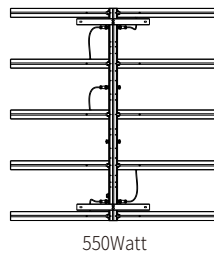
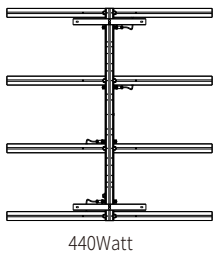

Daisy Chain up to 10 bars on a single power cord.

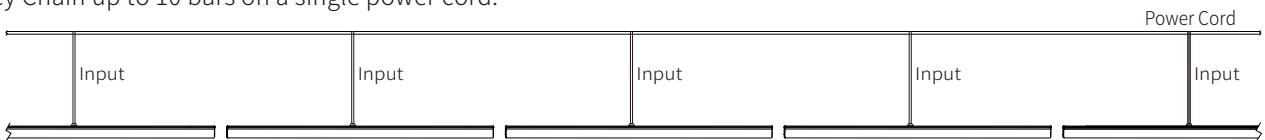

Hanging Method

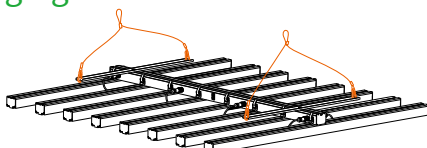

Method 1

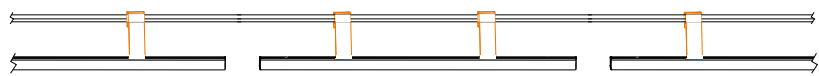

Method 2

