

2SC930

T-31-15
T-31-17

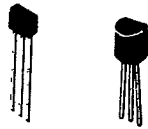

2033 2003A

NPN, Epitaxial Planar
Silicon Transistor

AM Converter, FM RF · IF Amp Applications

©545E

The 2SC930 has two types of package: SPA and NP.

Use

- FM RF amp, mixer, OSC, converter, and IF amplifier.

Absolute Maximum Ratings at Ta=25°C

| | 2SC930SPA | 2SC930NP | unit | |
|------------------------------|------------------|-------------|-------------|----|
| Collector to Base Voltage | V _{CB0} | 30 | 30 | V |
| Collector to Emitter Voltage | V _{CEO} | 20 | 20 | V |
| Emitter to Base Voltage | V _{EBO} | 5 | 5 | V |
| Collector Current | I _C | 30 | 30 | mA |
| Collector Dissipation | P _C | 120 | 250 | mW |
| Junction Temperature | T _j | 125 | 125 | °C |
| Storage Temperature | T _{stg} | -40 to +125 | -55 to +125 | °C |

Electrical Characteristics at Ta=25°C

| | | | min | typ | max | unit |
|------------------------------------|-------------------|---|-----|-----|------|------|
| Collector Cutoff Current | I _{CBO} | V _{CB} =10V, I _E =0 | | | 1 | uA |
| Emitter Cutoff Current | I _{EBO} | V _{EB} =4V, I _C =0 | | | 1 | uA |
| DC Current Gain | h _{FE} | V _{CE} =6V, I _C =1mA | 40* | 80 | 320* | |
| Gain Bandwidth Product | f _T | V _{CE} =6V, I _C =1mA | 170 | 300 | | MHz |
| Reverse Transfer capacitance | C _{re} | V _{CB} =6V, I _C =1MHz (2SC930SPA) | 0.8 | | 1.6 | pF |
| | | V _{CB} =6V, f=1MHz (2SC930NP) | 1.0 | 1.3 | 1.8 | pF |
| Base to Collector Time Constant | t _{bb'c} | V _{CE} =6V, I _C =1mA f=31.9MHz | | 20 | 36 | pS |
| Noise Figure | NF | V _{CE} =6V, I _C =1mA f=100MHz | | 4.0 | | dB |
| Turn-on Time | t _{on} | V _{IN} =+12V, V _{BB} =-3V, appointed circuit | | 30 | | ns |
| Turn-off Time | t _{off} | V _{IN} =-12V, V _{BB} =+3V, appointed circuit | | 30 | | ns |

*The 2SC930 is graded as follows by 1mA h_{FE}:

| | | | | | | | | | | | |
|----|---|----|----|---|-----|-----|---|-----|-----|---|-----|
| 40 | C | 80 | 60 | D | 120 | 100 | E | 200 | 160 | F | 320 |
|----|---|----|----|---|-----|-----|---|-----|-----|---|-----|

Case Outline 2033
(unit:mm)

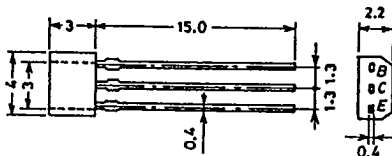

B: Base
C: Collector
E: Emitter
SANYO: SPA

Case Outline 2003A
(unit:mm)

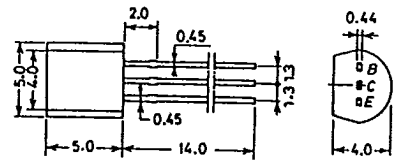

JEDEC: TO-92
EIAJ: SC-43
SANYO: NP
B. Base
C. Collector
E. Emitter

The 2SC930 is scheduled to be discontinued soon. Use the 2SC2839, instead of the 2SC930, in new applications where you are planning to use the 2SC930.

CASE OUTLINES AND ATTACHMENTS

www.DataSheet4U.com

- All of Sanyo Transistor case outlines are illustrated below.
- All dimensions are in mm, and dimensions which are not followed by min. or max. are represented by typical values.
- No marking is indicated.

Case Outline—[2003A]

unit:mm

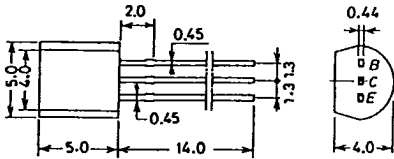

JEDEC: TO-92
EIAJ : SC-43
SANYO: NP

B. Base
C. Collector
E. Emitter

Case Outline—[2009A]

unit:mm

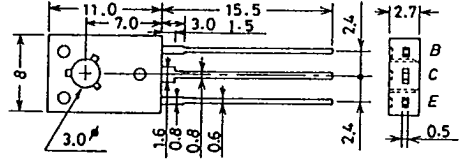

JEDEC: TO-126

B: Base
C: Collector
E: Emitter

Case Outline—[2004A]

unit:mm

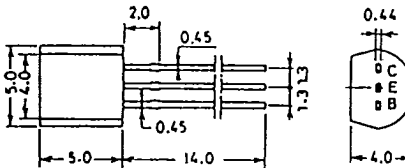

JEDEC: TO-92
EIAJ : SC-43
SANYO: NP

C. Collector
E. Emitter
B. Base

Case Outline—[2010A]

unit:mm

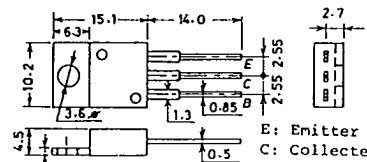

JEDEC: TO-220AB
EIAJ : SC-46

E: Emitter
C: Collector
B: Base

Case Outline—[2005A]

unit:mm

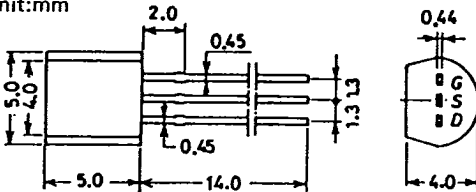

JEDEC: TO-92
EIAJ : SC-43
SANYO: NP

G: Gate
S: Source
D: Drain

Case Outline—[2012]

unit:mm

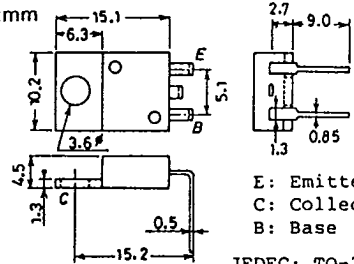

JEDEC: TO-220AA
EIAJ : SC-45

E: Emitter
C: Collector
B: Base

Case Outline—[2006A]

unit:mm

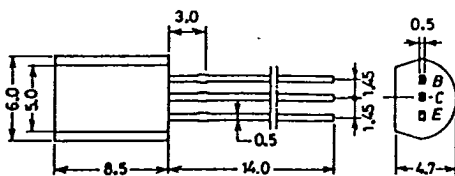

EIAJ : SC-51
SANYO: MP

B: Base
C: Collector
E: Emitter

Case Outline—[2013]

unit:mm

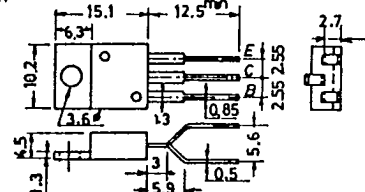

JEDEC TO-220

B: Base
C: Collector
E: Emitter

www.DataSheet4U.com

Case Outline—[2017]

unit:mm

www.DataSheet4U.com

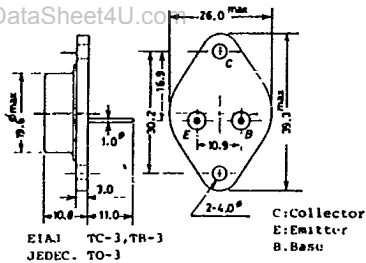

Case Outline—[2025]

unit:mm

T=91-20

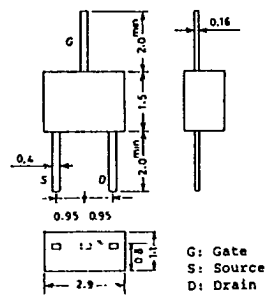

Case Outline—[2018A]

unit:mm

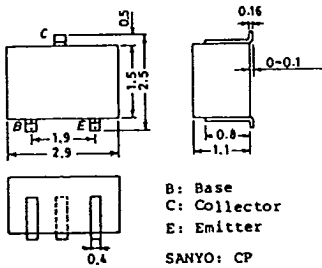

Case Outline—[2026]

unit:mm

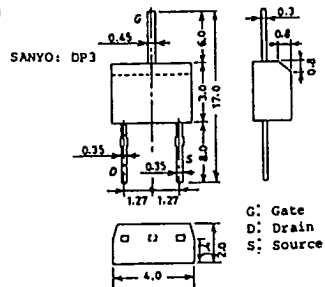

Case Outline—[2019A]

unit:mm

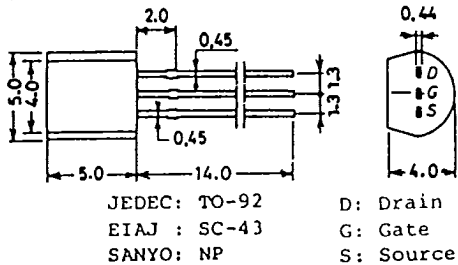

Case Outline—[2027A]

unit:mm

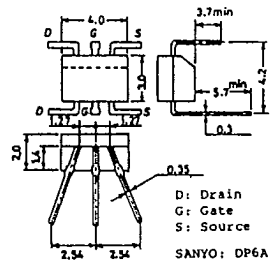

Case Outline—[2022]

unit:mm

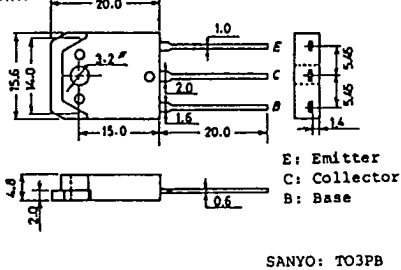

Case Outline—[2028A]

unit:mm

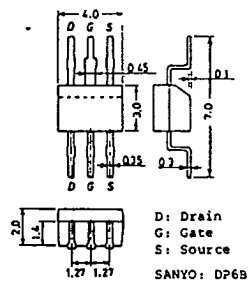

Case Outline—[2024A]

unit:mm

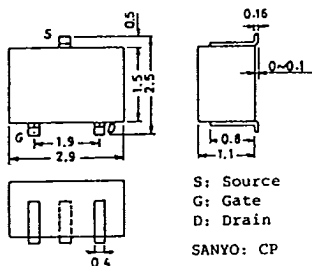

Case Outline—[2029A]

unit:mm

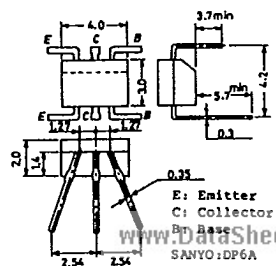

Case Outline-[2030A]

unit:mm

www.DataSheet4U.com

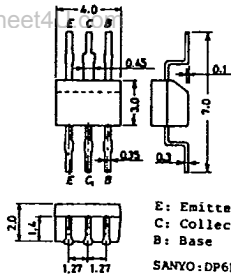

E: Emitter
C: Collector
B: Base
SANYO: DP6B

Case Outline-[2038]

unit:mm

T-91-20

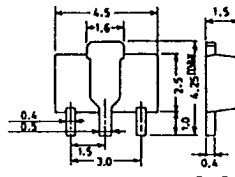

E: Emitter
C: Collector
B: Base
SANYO: PC1

Case Outline-[2031A]

unit:mm

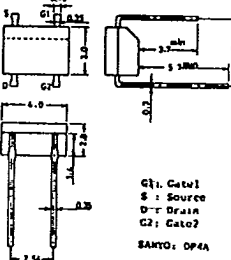

G: Gate
S: Source
D: Drain
C: Gato?
SANYO: DP4A

Case Outline-[2039]

unit:mm

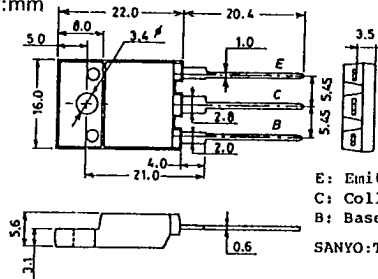

E: Emitter
C: Collector
B: Base
SANYO: TO3PML

Case Outline-[2033]

unit:mm

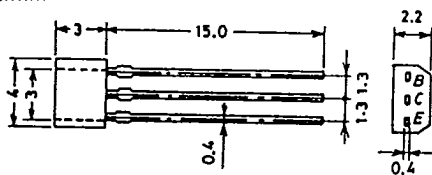

B: Base
C: Collector
E: Emitter
SANYO: SPA

Case Outline-[2040]

unit:mm

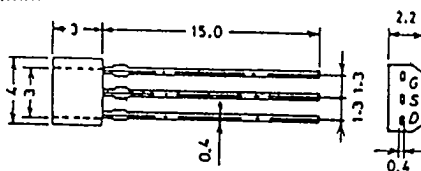

G: Gate
S: Source
D: Drain
SANYO: SPA

Case Outline-[2034]

unit:mm

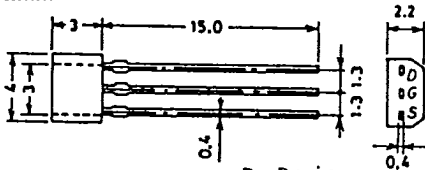

D: Drain
G: Gate
S: Source
SANYO: SPA

Case Outline-[2041]

unit:mm

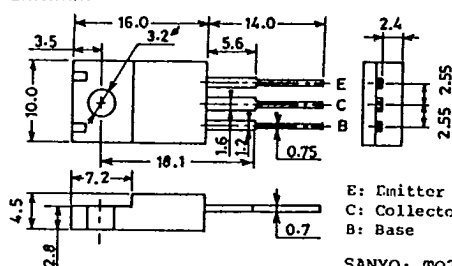

E: Emitter
C: Collector
B: Base
SANYO: TO220ML

Case Outline-[2037]

unit:mm

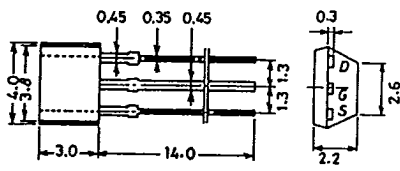

D: Drain
G: Gate
S: Source
SANYO: SP1

Case Outline-[2042A] unit:mm

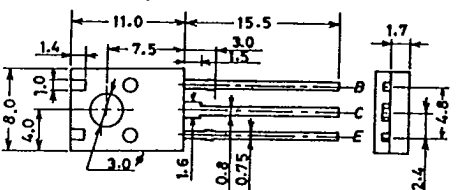

B: Base
C: Collector
E: Emitter
SANYO: TO126ML

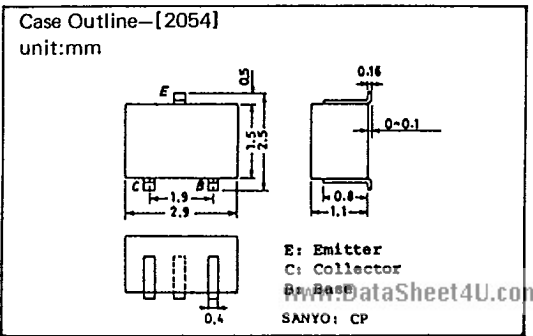
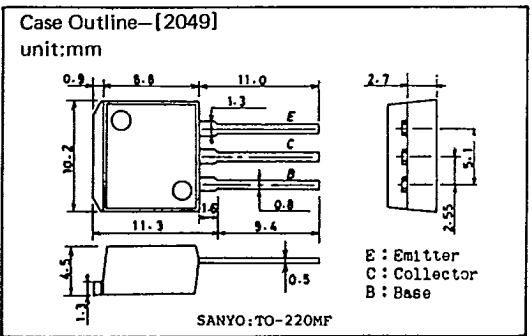
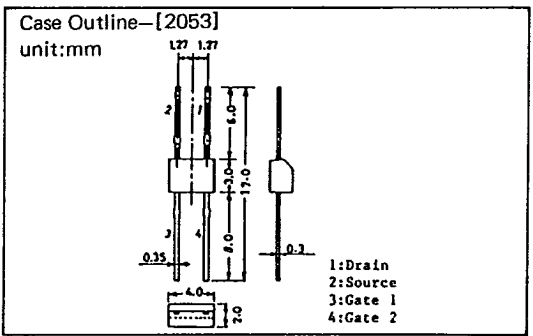
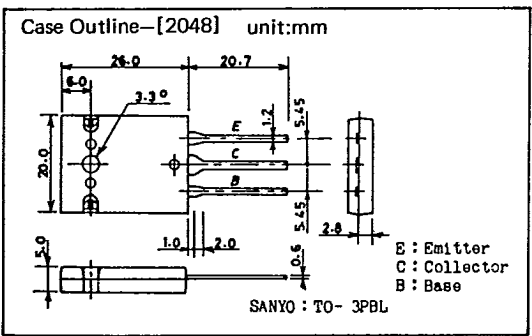
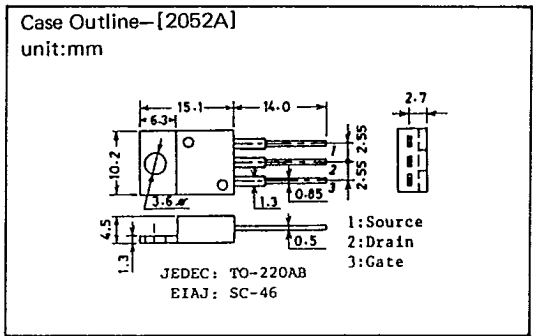
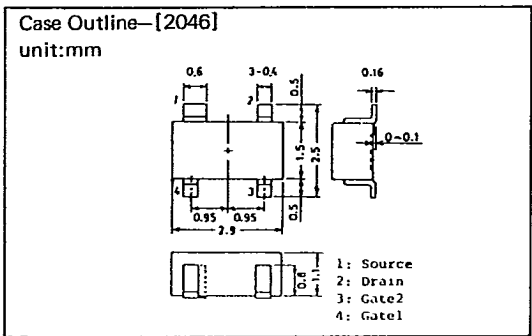
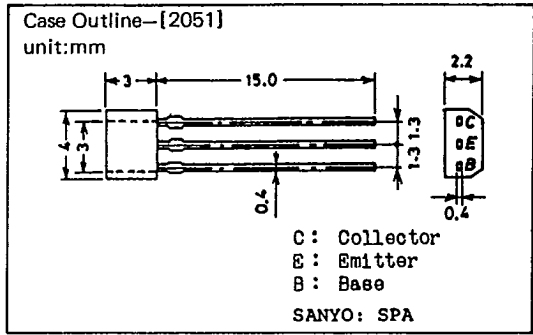
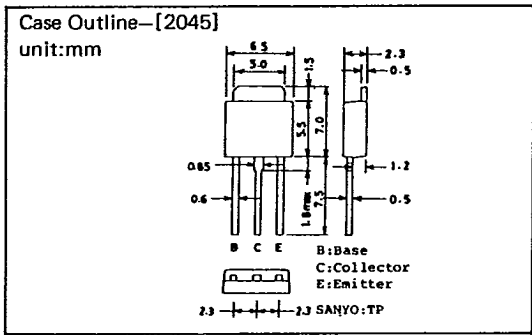
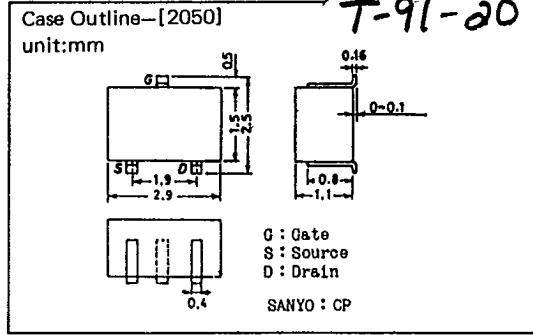
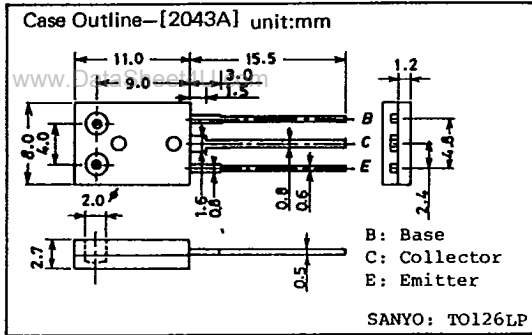

Case Outline—[2056] unit:mm

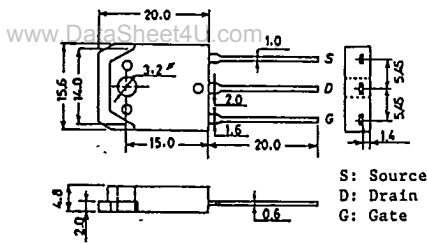

S: Source
D: Drain
G: Gate

SANYO: TO3PB

Case Outline—[0008] unit:mm

T-91-20

unit:mm

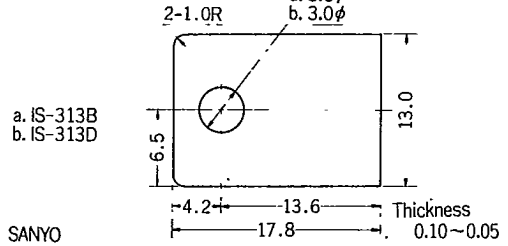

SANYO

Case Outline—[0004] unit:mm

unit:mm

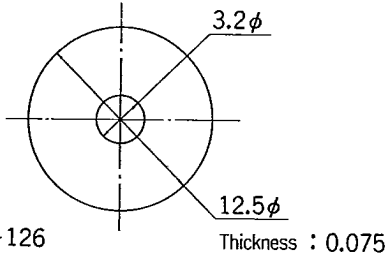

SANYO IS-126

Thickness : 0.075

Case Outline—[0009] unit:mm

unit:mm

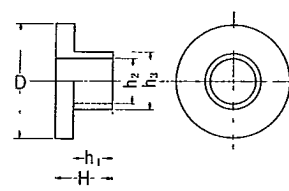

| Bush | D | H | h ₁ | h ₂ | h ₃ |
|------|-------|-----|----------------|----------------|----------------|
| A | 8.0φ | 4.0 | 2.8 | 3.1φ | 3.89φ |
| B | 8.0φ | 3.0 | 1.8 | 3.1φ | 3.89φ |
| C | 8.0φ | 5.7 | 4.5 | 3.1φ | 3.89φ |
| D | 8.0φ | 2.7 | 1.5 | 3.1φ | 3.89φ |
| E | 8.0φ | 3.4 | 2.2 | 3.1φ | 3.89φ |
| F | 8.0φ | 4.0 | 2.8 | 3.0φ | 3.59φ |
| K | 16.0φ | 3.4 | 1.4 | 3.1φ | 6.0φ |
| L | 6.0φ | 3.1 | 1.5 | 2.6φ | 3.5φ |
| M | 6.0φ | 3.1 | 1.5 | 3.0φ | 3.59φ |
| P | 6.0φ | 2.3 | 1.1 | 3.0φ | 3.59φ |

SANYO Bush

Case Outline—[0005] unit:mm

unit:mm

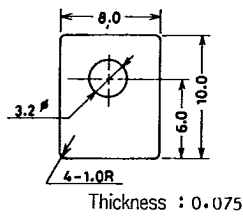

SANYO IS-126A Mica

Thickness : 0.075

Case Outline—[0010] unit:mm

unit:mm

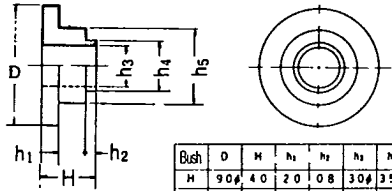

| Bush | D | H | h ₁ | h ₂ | h ₃ | h ₄ | h ₅ |
|------|-------|-----|----------------|----------------|----------------|----------------|----------------|
| H | 9.0φ | 4.0 | 2.0 | 0.8 | 3.0φ | 3.59φ | 5.6φ |
| T | 9.0φ | 5.8 | 2.0 | 2.6 | 3.0φ | 3.59φ | 5.6φ |
| UB | 16.0φ | 6.8 | 1.5 | 3.3 | 3.0φ | 3.89φ | 8.0φ |

SANYO Bush

Case Outline—[0006] unit:mm

unit:mm

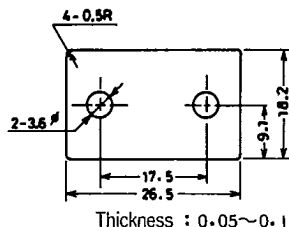

SANYO IS-20MA Mica

Thickness : 0.05~0.1

Case Outline—[0011] unit:mm

unit:mm

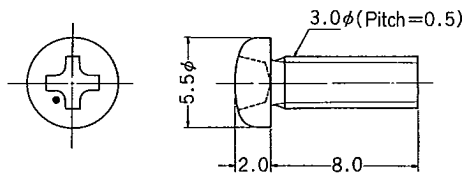

JIS No. B1111 M3×0.5

Case Outline—[0007] unit:mm

unit:mm

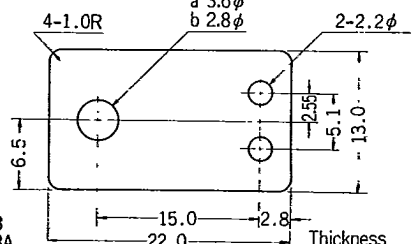

a. IS-313
b. IS-313A

Thickness
0.10~0.05

Case Outline—[0012] unit:mm

unit:mm

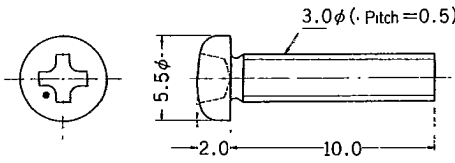

JIS No. B1111 M3×0.5

www.DataSheet4U.com

Case Outline-[0013]

unit:mm

www.DataSheet4U.com

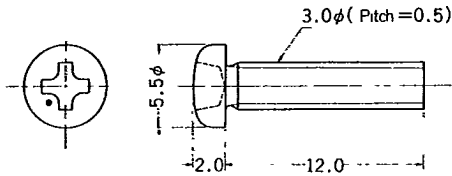

JIS No. B1111 M3x0.5

Case Outline-[0018]

unit:mm

T=91-20

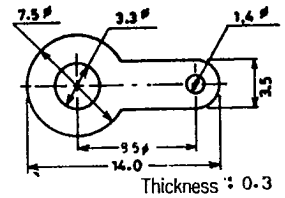

SANYO Lug 1.4

Case Outline-[0014]

unit:mm

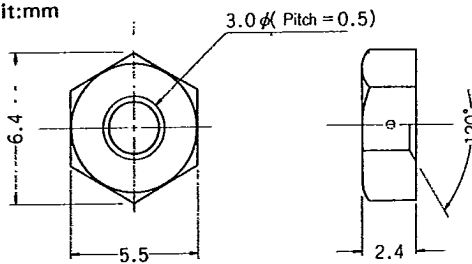

JIS No. B1181 M3x0.5

Case Outline-[0019]

unit:mm

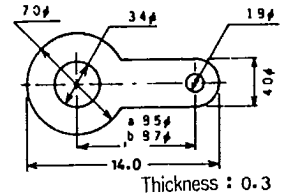

SANYO Lug 1.8φ

Case Outline-[0015]

unit:mm

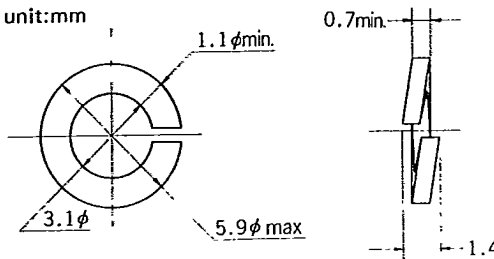

JIS No. B 1251 Spring washer (M3)

Case Outline-[0020]

unit:mm

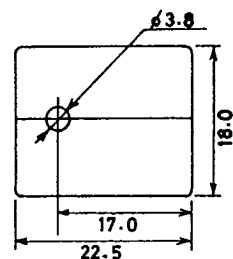

SANYO IS-3MP Mica

Case Outline-[0016]

unit:mm

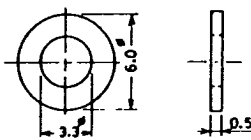

JIS No. B1252 Flat washer

Case Outline-[0021]

unit:mm

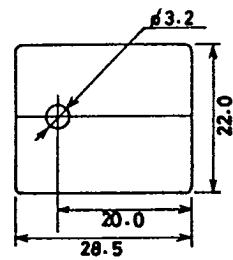

SANYO IS-MPC Mica

Case Outline-[0017]

unit:mm

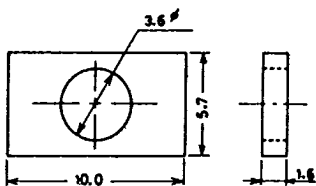

JIS No. G3141 Rectangular washer

Case Outline-[0022]

unit:mm

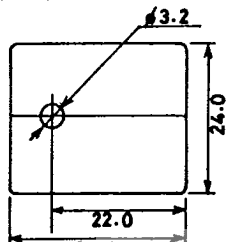

SANYO IS-3PBL Mica

www.DataSheet4U.com